

PRO·FORM[®] CT 1160

Model No. PFTL09911

Serial No. _____

Write the serial number in the space above for future reference.

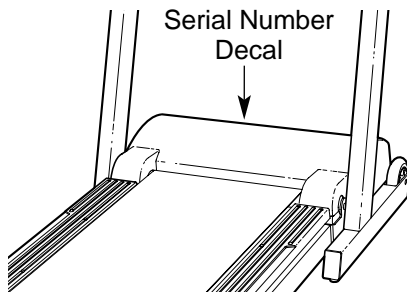

USER'S MANUAL

QUESTIONS?

If you have questions, or if there are missing parts, we will guarantee complete satisfaction through direct assistance from our factory.

TO AVOID UNNECESSARY DELAYS, PLEASE CALL DIRECT TO OUR TOLL-FREE CUSTOMER HOT LINE. The trained technicians on our customer hot line will provide immediate assistance, free of charge.

CUSTOMER HOT LINE:

1-800-999-3756

Mon.–Fri., 6 a.m.–6 p.m. MST

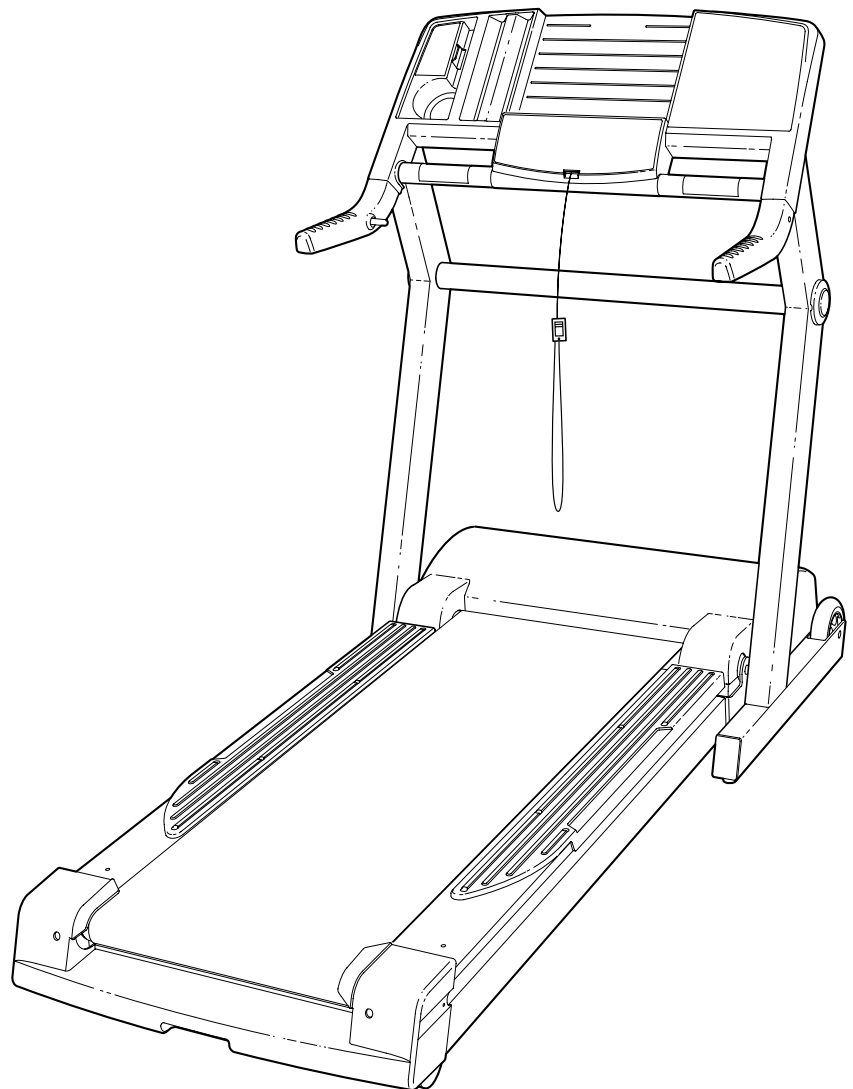

⚠ CAUTION

Read all precautions and instructions in this manual before using this equipment. Save this manual for future reference.



Visit our website at

www.proform.com

new products, prizes,
fitness tips, and much more!

PRO·FORM[®] CT 1160

TABLE OF CONTENTS

IMPORTANT PRECAUTIONS	3
BEFORE YOU BEGIN	5
ASSEMBLY	6
TREADMILL OPERATION	7
HOW TO FOLD AND MOVE THE TREADMILL	21
TROUBLE-SHOOTING	22
EXERCISE GUIDELINES	24
PART LIST	26
HOW TO ORDER REPLACEMENT PARTS	Back Cover
LIMITED WARRANTY	Back Cover

Note: An EXPLODED DRAWING is attached in the center of this manual.

IMPORTANT PRECAUTIONS

⚠ WARNING: To reduce the risk of burns, fire, electric shock, or injury to persons, read the following important precautions and information before operating the treadmill.

1. It is the responsibility of the owner to ensure that all users of this treadmill are adequately informed of all warnings and precautions.
2. Use the treadmill only as described in this manual.
3. Place the treadmill on a level surface, with at least eight feet of clearance behind it and two feet on each side. Do not place the treadmill on any surface that blocks air openings. To protect the floor or carpet from damage, place a mat under the treadmill.
4. Keep the treadmill indoors, away from moisture and dust. Do not put the treadmill in a garage or covered patio, or near water.
5. Do not operate the treadmill where aerosol products are used or where oxygen is being administered.
6. Keep children under the age of 12 and pets away from the treadmill at all times.
7. The treadmill should not be used by persons weighing more than 250 pounds. Never allow more than one person on the treadmill at a time.
8. Wear appropriate exercise clothing when using the treadmill. Do not wear loose clothing that could become caught in the treadmill. Athletic support clothes are recommended for both men and women. Always wear athletic shoes. Never use the treadmill with bare feet, wearing only stockings, or in sandals.
9. When connecting the power cord (see page 7), plug the power cord into a surge suppressor (not included) and plug the surge suppressor into a grounded circuit capable of carrying 15 or more amps. No other appliance should be on the same circuit. Do not use an extension cord.
10. Use only a single-outlet surge suppressor that meets all of the specifications described on page 7. To purchase a surge suppressor, see your local PROFORM dealer or call 1-800-806-3651 and order part number 146148.
11. Failure to use a properly functioning surge suppressor could result in damage to the control system of the treadmill. If the control system is damaged, the walking belt may change speed or stop unexpectedly, which may result in a fall and serious injury.
12. Keep the power cord and the surge suppressor away from heated surfaces.
13. Never move the walking belt while the power is turned off. Do not operate the treadmill if the power cord or plug is damaged, or if the treadmill is not working properly. (See **BEFORE YOU BEGIN** on page 5 if the treadmill is not working properly.)
14. Never start the treadmill while you are standing on the walking belt. Always hold the handrails while using the treadmill.
15. The treadmill is capable of high speeds. Adjust the speed in small increments to avoid sudden jumps in speed.
16. Do not use the hand weights at speeds faster than walking speeds. Using hand weights and not holding the handrails may compromise your ability to maintain your balance. Exercises using hand weights should be attempted only by experienced users.
17. The pulse sensor is not a medical device. Various factors, including the user's movement, may affect the accuracy of heart rate readings. The pulse sensor is intended only as an exercise aid in determining heart rate trends in general.
18. Never leave the treadmill unattended while it is running. Always remove the key, unplug the power cord, and move the on/off switch to the off position when the treadmill is not in use. (See the drawing on page 5 for the location of the on/off switch.)
19. Do not attempt to raise, lower, or move the treadmill until it is properly assembled. (See **ASSEMBLY** on page 6, and **HOW TO FOLD AND MOVE THE TREADMILL** on page 21.) You must be able to safely lift 45 pounds (20 kg) to raise, lower, or move the treadmill.
20. When folding or moving the treadmill, make sure that the storage latch is fully closed.

21. When using iFIT.com CDs and videos, an electronic “chirping” sound will alert you when the speed and/or incline of the treadmill is about to change. Always listen for the “chirp” and be prepared for speed and/or incline changes. In some instances, the speed and/or incline may change before the personal trainer describes the change.

22. When using iFIT.com CDs and videos, you can manually override the speed and incline settings at any time by pressing the speed and incline buttons. However, when the next “chirp” is heard, the speed and/or incline will change to the next settings of the CD or video program.

23. Always remove iFIT.com CDs and videos from your CD player or VCR when you are not using them.

24. Inspect and properly tighten all parts of the treadmill every three months.

25. Never drop or insert any object into any opening.

26. **DANGER:** Always unplug the power cord immediately after use, before cleaning the treadmill, and before performing the maintenance and adjustment procedures described in this manual. Never remove the motor hood unless instructed to do so by an authorized service representative. Servicing other than the procedures in this manual should be performed by an authorized service representative only.

27. The treadmill is intended for in-home use only. Do not use the treadmill in any commercial, rental, or institutional setting.

⚠ WARNING: Before beginning this or any exercise program, consult your physician. This is especially important for persons over the age of 35 or persons with pre-existing health problems. Read all instructions before using. ICON assumes no responsibility for personal injury or property damage sustained by or through the use of this product.

SAVE THESE INSTRUCTIONS

The decals shown below have been placed on your treadmill. If a decal is missing, or if it is not legible, please call our Customer Service Department toll-free at 1-800-999-3756 to order a free replacement decal. Apply the decal in the location shown. Note: The long decal is shown at 38% of actual size.

⚠ WARNING: Protect yourself and others from risk of serious injury. Read the user’s manual and:

- Fully engage storage latch before treadmill is moved or stored.
- Reduce incline to lowest level before folding treadmill into storage position.
- Stand only on side rails when starting or stopping treadmill.
- Change speed in small increments.
- Hold handrails to prevent falling, and always wear the safety clip while operating treadmill.
- Stop if you feel faint, dizzy, or short of breath.
- Never allow children on or around treadmill.
- Remove key when not in use.
- Keep clothing, fingers, and hair away from moving belt.
- Never try to adjust or fix the belt while it is moving.
- Always wear athletic shoes while operating treadmill.



⚠ CAUTION
KEEP HANDS AND FEET AWAY FROM THIS AREA WHILE THE TREADMILL IS IN OPERATION.

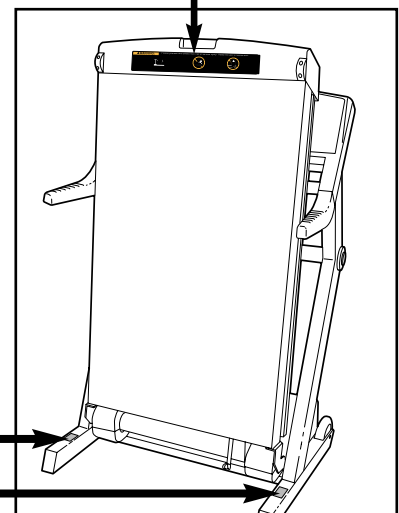

BEFORE YOU BEGIN

Congratulations for purchasing the PROFORM® CT 1160 treadmill. From the advanced console to the cushioned walking platform, the CT 1160 is designed to make your workouts at home more effective and enjoyable. And when you're not exercising, the CT 1160 can be folded away, taking less than half the floor space of conventional treadmills.

For your benefit, read this manual carefully before using the treadmill. If you have additional questions, please call our Customer Service Department toll-free

at 1-800-999-3756, Monday through Friday, 6 a.m. until 6 p.m. Mountain Time (excluding holidays). To help us assist you, please note the product model number and serial number before calling. The model number is PFTL09911. The serial number can be found on a decal attached to the treadmill (see the front cover of this manual for the location).

Before reading further, please familiarize yourself with the parts that are labeled in the drawing below.

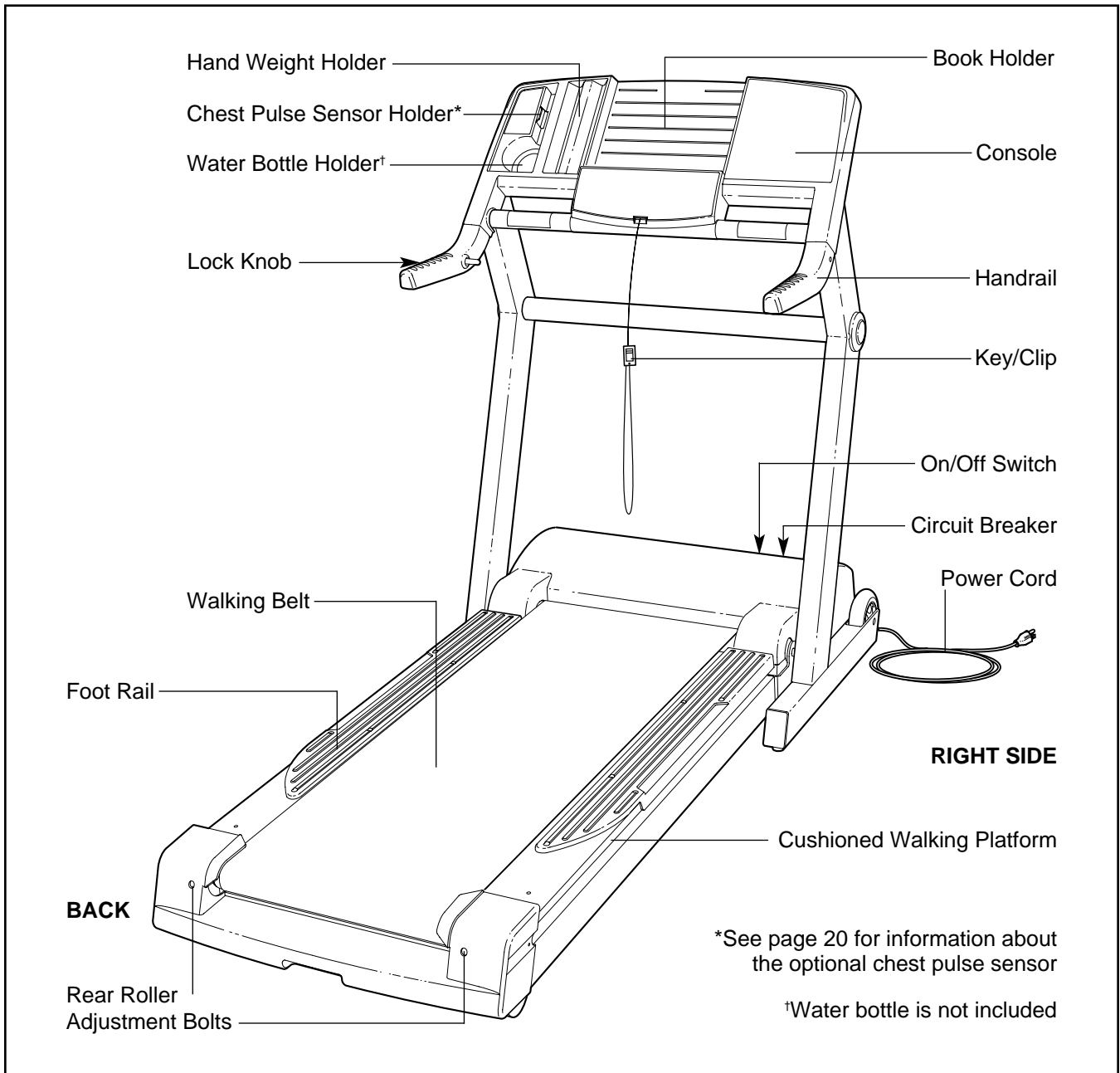

ASSEMBLY

Assembly requires two people. Place the treadmill in a cleared area and remove all packing materials. Do not dispose of the packing materials until the treadmill is assembled. **No tools are required.**

Note: The underside of the treadmill walking belt is coated with high-performance lubricant. During shipping, a small amount of lubricant may be transferred to the top of the walking belt, the sides of the walking platform, or the shipping carton. This does not affect treadmill performance. If there is lubricant on top of the walking belt or on the sides of the walking platform, wipe off the lubricant with a soft cloth and a mild, non-abrasive cleaner.

1. **With the help of a second person,** carefully raise the Uprights (65) until the Wheels (77) are resting on the floor as shown.

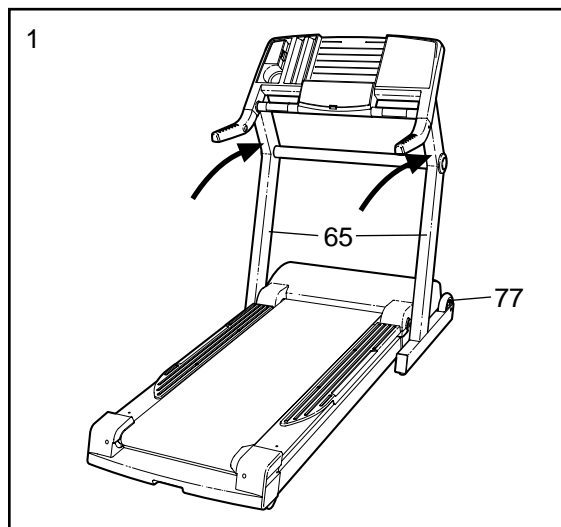

2. Remove the Lock Knob (67) from the Lock Pin (72). Make sure that the Lock Pin Collar (70) and the Spring (69) are on the Lock Pin. (Note: If there are two Lock Pin Collars, there should be one Lock Pin Collar on each side of the Spring.) Insert the Lock Pin into the left Handrail (62), and tighten the Lock Knob onto it.

After assembly has been completed, pull on the Left Foam Grip (62) in the direction shown until the Latch Pin (72) slides freely.

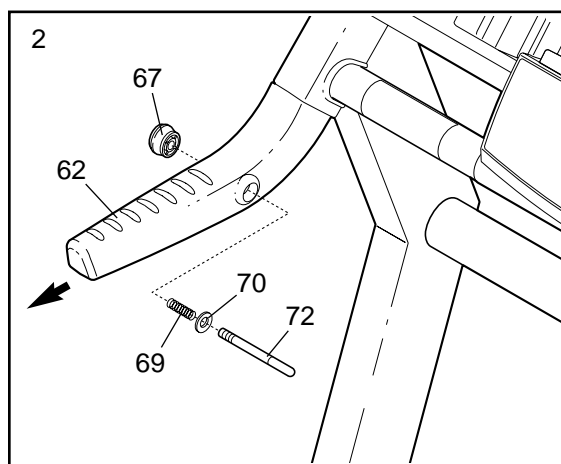

3. **Make sure that all parts are tightened before you use the treadmill. Place a mat beneath the treadmill to protect the floor or carpet.** For your benefit, we recommend that you familiarize yourself with the TROUBLE-SHOOTING section on pages 22 and 23.

TREADMILL OPERATION

THE PERFORMANT LUBE™ WALKING BELT

Your treadmill features a walking belt coated with PERFORMANT LUBE™, a high-performance lubricant. **IMPORTANT: Never apply silicone spray or other substances to the walking belt or the walking platform. Such substances will deteriorate the walking belt and cause excessive wear.**

HOW TO PLUG IN THE POWER CORD

⚠ DANGER: Improper connection of the equipment-grounding conductor can result in an increased risk of electric shock. Check with a qualified electrician or serviceman if you are in doubt as to whether the product is properly grounded. Do not modify the plug provided with the product—if it will not fit the outlet, have a proper outlet installed by a qualified electrician.

Your treadmill, like any other type of sophisticated electronic equipment, can be seriously damaged by sudden voltage changes in your home's power. Voltage surges, spikes, and noise interference can result from weather conditions or from other appliances being turned on or off. **To decrease the possibility of your treadmill being damaged, always use a surge suppressor with your treadmill (see drawing 1 at the right).** To purchase a surge suppressor, see your local PROFORM dealer or call 1-800-806-3651 and order part number 146148.

Use only a single-outlet surge suppressor that is UL 1449 listed as a transient voltage surge suppressor (TVSS). The surge suppressor must have a UL suppressed voltage rating of 400 volts or less and a minimum surge dissipation of 450 joules. The surge suppressor must be electrically rated for 120 volts AC and 15 amps. There must be a monitoring light on the surge suppressor to indicate whether it is functioning properly. Failure to use a properly functioning surge suppressor could result in damage to the control system of the treadmill. If the control system is damaged, the walking belt may change speed or stop unexpectedly, which may result in a fall and serious injury.

This product must be grounded. If it should malfunction or break down, grounding provides a path of least resistance for electric current to reduce the risk of electric shock. This product is equipped with a cord having

an equipment-grounding conductor and a grounding plug. **Plug the power cord into a surge suppressor, and plug the surge suppressor into an appropriate outlet that is properly installed and grounded in accordance with all local codes and ordinances. Important: The treadmill is not compatible with GFCI-equipped outlets.**

This product is for use on a nominal 120-volt circuit, and has a grounding plug that looks like the plug illustrated in drawing 1 below. A temporary adapter that looks like the adapter illustrated in drawing 2 may be used to connect the surge suppressor to a 2-pole receptacle as shown in drawing 2 if a properly grounded outlet is not available.

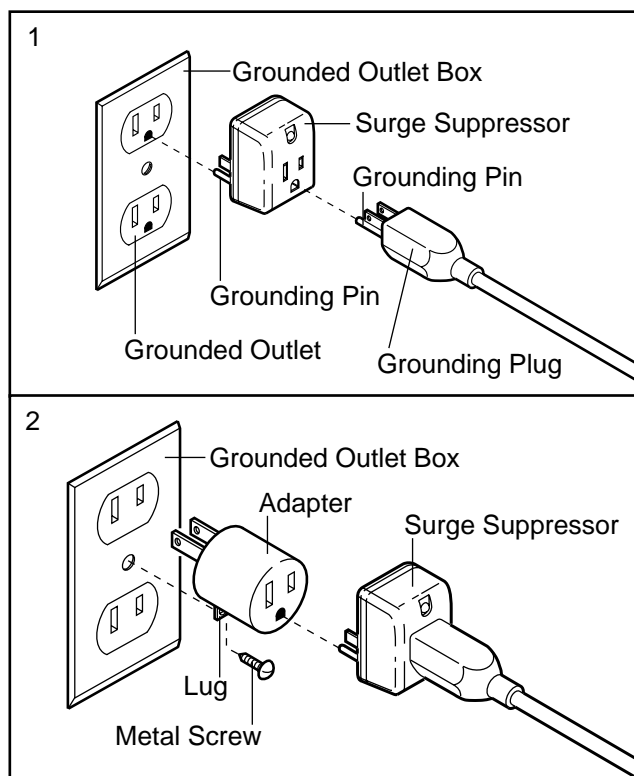

The temporary adapter should be used only until a properly grounded outlet (drawing 1) can be installed by a qualified electrician.

The green-colored rigid ear, lug, or the like extending from the adapter must be connected to a permanent ground such as a properly grounded outlet box cover. Whenever the adapter is used it must be held in place by a metal screw. **Some 2-pole receptacle outlet box covers are not grounded. Contact a qualified electrician to determine if the outlet box cover is grounded before using an adapter.**

DIAGRAM OF THE CONSOLE

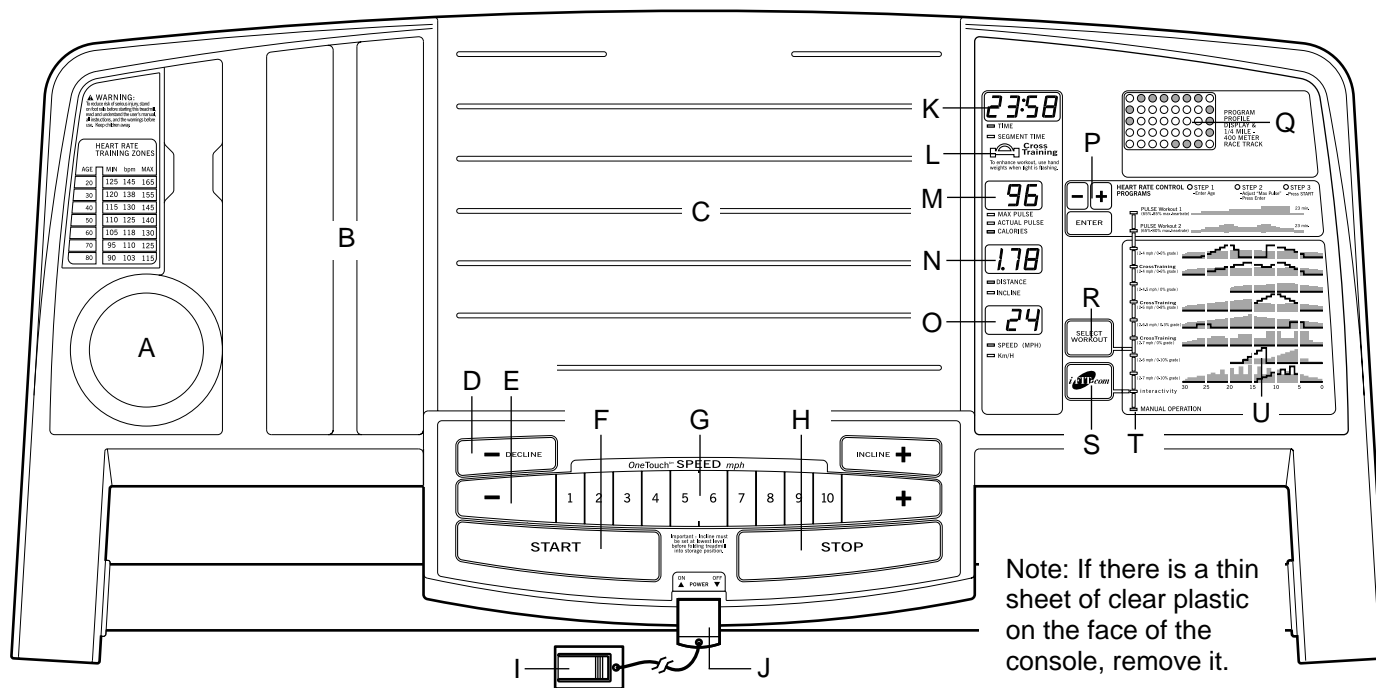

FEATURES OF THE CONSOLE

The treadmill console offers an impressive selection of features to help you get the most from your exercise.

When the console is in the manual mode, the speed and incline of the treadmill can be changed with a touch of a button. As you exercise, the four displays will show your workout time, the number of calories you have burned, the distance you have walked, the incline level of the treadmill, and the speed of the walking belt. The console will also show your heart rate when you use the handgrip pulse sensor or the optional chest pulse sensor (see page 20).

The console also offers eight preset workout programs. Each program automatically controls the speed and incline of the treadmill as it guides you through an effective workout. The included hand weights can be used for upper body exercise as well. Two pulse programs are also offered. Each program automatically adjusts the speed and incline of the treadmill to keep your heart rate within a preset range during your workout.

The console also features new iFIT.com interactive technology. iFIT.com technology is like having a personal trainer right in your home. Using the included audio cable, you can connect the treadmill to your home stereo, portable stereo, or computer and play special iFIT.com CD programs (iFIT.com CDs are avail-

able separately). iFIT.com CD programs automatically control the speed and incline of the treadmill as a personal trainer guides you through every step of your workout. High-energy music provides added motivation. Each CD features two programs designed by certified personal trainers.

In addition, you can connect the treadmill to your VCR and TV and play iFIT.com video programs (videocassettes are available separately). Video programs offer the same benefits as iFIT.com CD programs, but add the excitement of working out with a class and an instructor—the hottest new trend at health clubs.

With the treadmill connected to your computer, you can also go to our Web site at www.iFIT.com and access basic programs, audio programs, and video programs directly from the internet. Additional options are soon to be available. See www.iFIT.com for details.

To purchase iFIT.com CDs or videocassettes, call toll-free 1-800-735-0768. For information about an optional chest pulse sensor, see page 20.

To use the manual mode of the console, follow the steps beginning on page 10. **To use preset programs**, see page 12. **To use pulse programs**, see page 13. **To use iFIT.com CD or video programs**, see page 17. **To use iFIT.com programs directly from our Web site**, see page 19.

DESCRIPTION OF THE CONSOLE

Refer to the drawing on page 8 to identify the features described below.

- A. Water bottle holder—This convenient holder keeps your water bottle handy during your workouts.
- B. Hand weight holder—These compartments hold the included hand weights.
- C. Book holder—This area is designed to hold a book or magazine.
- D. Incline buttons—These buttons control the incline of the treadmill. Each time a button is pressed, the incline will change by 0.5%. The incline range is 0% to 10%.
- E. Speed buttons—These buttons control the speed of the walking belt. Each time a button is pressed, the speed will change by 0.1 mph; if a button is held down, the speed will change in increments of 0.5 mph. The speed range is 0.5 mph to 10 mph.
- F. Start button—This button is used to start the walking belt.
- G. OneTouch Speed buttons—These buttons allow you to quickly select speed settings.
- H. Stop button—This button is used to stop the walking belt.
- I. Waistband clip—This clip is designed to be worn on the waistband of your clothes. If the key is pulled from the console, the walking belt will automatically stop.
- J. Key—This key turns the console on and off.
- K. Time/Segment Time display—When the manual mode or the iFIT.com mode is selected, this display will show the elapsed time. When a preset program or a pulse program is selected, the display will show both the time remaining in the program and the time remaining in the current segment of the program. The display will alternate between one number and the other every seven seconds.
- L. Cross Training indicator—During the three cross training programs, this indicator will periodically flash. The included hand weights can be used while the indicator is flashing to add upper body exercise to your workouts.
- M. Pulse/Calories display—This display shows the approximate number of calories you have burned. When the handgrip pulse sensor is used, the display will show your heart rate. If the optional chest pulse sensor is worn, the display will show your heart rate and the number of calories you have burned, alternating between one number and the other every seven seconds.
- N. Distance/Incline display—This display shows the distance you have walked and the incline level of the treadmill. The display will alternate between one number and the other every seven seconds. Note: Each time the Incline buttons are pressed, the display will change to show the incline setting.
- O. Speed display—This display shows the speed of the walking belt.
- P. Enter button and + and – buttons—These buttons are used to enter your age when pulse programs are used.
- Q. Program display—When the manual mode or the iFIT.com mode is selected, this display will show your progress on an LED track. When a preset program or a pulse program is selected, the display will show the settings for the program.
- R. Select Workout button—This button is used to select the manual mode, the preset programs, and the pulse programs. Note: If the walking belt is moving when the Select Workout button is pressed, the walking belt will slow to a stop, the displays will be reset, and a new program or the manual mode will be selected.
- S. iFIT.com button—This button is used to select the iFIT.com mode.
- T. Mode indicators—These indicators show whether the manual mode, a preset program, a pulse program, or the iFIT.com mode is selected.
- U. Program profiles—These profiles show how the speed and incline of the treadmill will change during preset programs and how the target heart rate will change during pulse programs.

Note: The console can display exercise feedback in either miles or kilometers (see SPEED DISPLAY on page 11). For simplicity, all instructions in this section refer to miles.

⚠ WARNING: To reduce the risk of serious injury, read the following precautions before operating the console.

- Do not stand on the walking belt when turning on the power or starting the walking belt.
- Always wear the clip (see “I” on page 8) on the waistband of your clothes while you are using the treadmill. If the key is pulled from the console, the walking belt will stop.
- The treadmill is capable of high speeds. Adjust the speed in small increments.
- To reduce the risk of electric shock, keep liquids away from the console and place only a sealed water bottle in the console.

HOW TO TURN ON THE POWER

1 Plug in the power cord (see HOW TO PLUG IN THE POWER CORD on page 7).

2 Locate the on/off switch on the front of the treadmill near the power cord. Move the on/off switch to the on position.

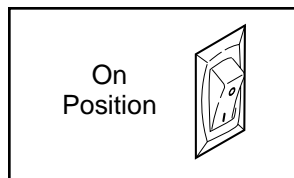

3 Stand on the foot rails of the treadmill. Find the clip attached to the key and slide the clip fully onto the waistband of your clothes. Next, insert the key into the console. After a moment, the displays, the LED track, and various indicators will light. **Test the clip by carefully taking a few steps backward until the key is pulled from the console. If the key is not pulled from the console, adjust the position of the clip as needed.** Then, reinsert the key into the console.

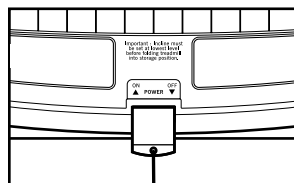

HOW TO USE THE MANUAL MODE

1 Insert the key into the console.

See HOW TO TURN ON THE POWER at the left.

2 Select the manual mode.

When the key is inserted, the manual mode will be selected and the manual indicator will light. If a program is selected, press the Select Workout button repeatedly to select the manual mode.

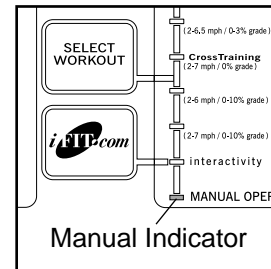

3 Press the Start button or the Speed + button to start the walking belt.

A moment after the button is pressed, the walking belt will begin to move at 1 mph. Hold the handrails and begin walking.

As you exercise, adjust the speed of the walking belt as desired by pressing the Speed buttons or the OneTouch Speed buttons. Note: After the buttons are pressed, it may take a moment for the walking belt to reach the selected speed setting.

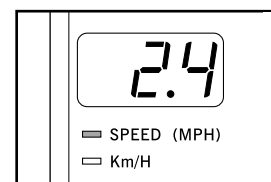

To stop the walking belt, press the Stop button. The displays will pause and the Time/Segment Time display will begin to flash. To restart the walking belt, press the Start button or the Speed + button. To stop the walking belt and reset the displays, press the Stop button, remove the key, and then reinsert the key.

During the first few minutes that you use the treadmill, inspect the alignment of the walking belt, and align the walking belt if necessary (see page 23).

4 Adjust the incline of the treadmill as desired.

To vary the intensity of your exercise, adjust the incline of the treadmill by pressing the Incline buttons. Note: After the buttons are pressed, it may take a moment for the treadmill to reach the selected incline setting.

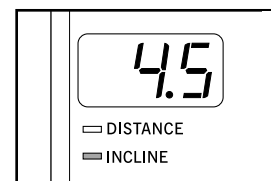

5 Follow your progress with the LED track and the four displays.

LED Track—When the manual mode or the iFIT.com mode is selected, the program display will show a track representing a distance of 1/4 mile. As you exercise, the indicators around the track will light one at a time until the entire track is lit. A new lap will then begin.

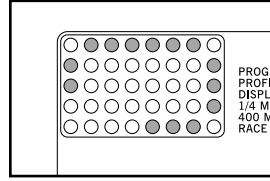

Time/Segment Time display—When the manual mode or the iFIT.com mode is selected, this display will show the elapsed time. When a preset program or a pulse program is selected, the display will show both the time remaining in the program and the time remaining in the current segment of the program. The display will alternate between one number and the other every seven seconds.

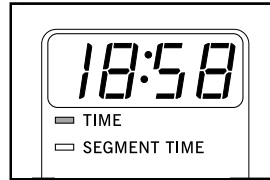

Pulse/Calories display—This display shows the approximate number of calories you have burned. If the optional chest pulse sensor is worn, the display will also show your heart rate. The display will alternate between one number and the other every seven seconds. If the handgrip pulse sensor is used, the display will show your heart rate continuously while your hands are on the pulse sensor.

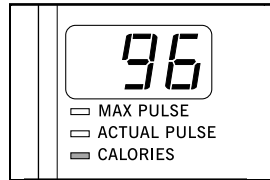

To use the handgrip pulse sensor, **stand on the foot rails** and place your hands on the metal contacts on the handrail as shown—**avoid moving your hands**. After a few seconds, one or two dashes will appear in the Pulse/Calories display and then your heart rate will be shown. **For the most accurate heart rate reading, hold the contacts for about 15 seconds.**

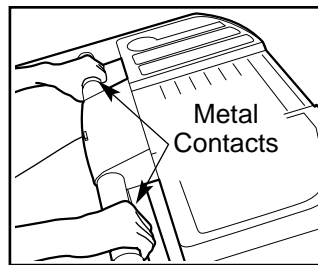

Distance/Incline display—This display shows the distance you have walked and the incline level of the treadmill. The display will alternate between one number and the other every seven seconds. Note: Each time the Incline buttons are pressed, the display will change to show the incline setting.

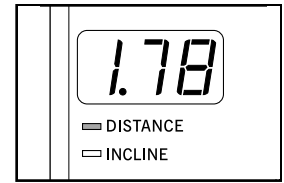

Speed display—This display shows the speed of the walking belt.

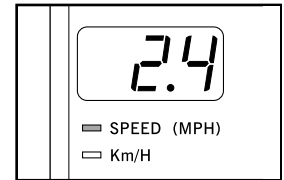

Note: The speed can be displayed in either miles per hour or kilometers per hour. The MPH or Km/H indicator below the Speed display will light to show which unit of measurement is selected. To change the unit of measurement, first hold down the Stop button while inserting the key into the console. The Speed display will show an E for English miles or an M for metric kilometers. Pressing the Speed + button will change the unit of measurement. When the desired unit of measurement is selected, remove and then reinsert the key.

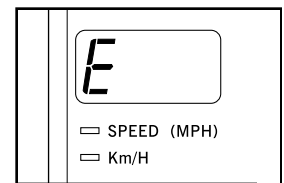

6 When you are finished exercising, stop the walking belt and remove the key.

Step onto the foot rails, press the Stop button, and adjust the incline of the treadmill to the lowest level. **The incline must be at the lowest level when the treadmill is raised to the storage position or the treadmill will be damaged.** Next, remove the key from the console and put it in a secure place. **Note: If the displays and indicators on the console remain lit after the key is removed, the console is in the “demo” mode. Refer to page 20 and turn off the demo mode.**

When you are finished using the treadmill, move the on/off switch near the power cord to the off position and unplug the power cord.

HOW TO USE THE PRESET PROGRAMS

1 Insert the key into the console.

See HOW TO TURN ON THE POWER on page 10.

2 Select one of the eight preset programs.

When the key is inserted, the manual mode will be selected. To select one of the preset programs, press the Select Workout button

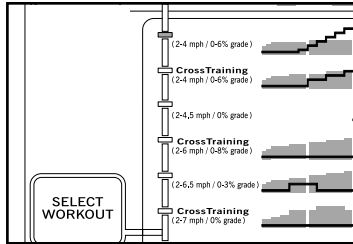

repeatedly until one of the eight preset program indicators lights. When a preset program is selected, the Distance/Incline display will flash the maximum incline setting for the program for six seconds, and the Speed display will flash the maximum speed setting.

The profiles printed on the right side of the console show how the speed and incline of the treadmill will change during the preset programs. The numbers at the left ends of the profiles show the speed and incline ranges for the programs. The program display will show a simplified profile of the program. The Time/Segment Time display will show how long the selected program will last.

3 Press the Start button or the Speed + button to start the program.

A moment after the button is pressed, the treadmill will automatically adjust to the first speed and incline settings for the program. Hold the handrails and begin walking.

Each program is divided into several time segments of different lengths. The Time/Segment Time display shows both the time remaining in the program and the time remaining in the current segment. One speed setting and one incline setting are programmed for each segment. The speed setting for the first segment will be shown in the flashing Current Segment column of the program display. (The incline settings are not shown

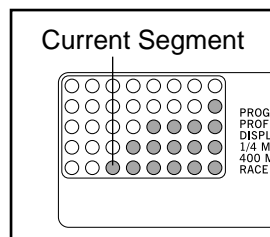

in the program display.) The speed settings for the next five segments will be shown in the five columns to the right.

When only three seconds remain in the first segment of the program, both the Current Segment column and the column to the right will flash and a tone will sound. In addition, if the speed and/or incline of the treadmill is about to change, the Speed display and/or the Distance/Incline display will flash to alert you, and three tones will sound. When the first segment is completed, all speed settings will move one column to the left. The speed setting for the second segment will then be shown in the flashing Current Segment column and the treadmill will automatically adjust to the speed and incline settings for the second segment.

The program will continue in this way until the speed setting for the final segment is shown in the Current Segment column and no time remains in the Time/Segment Time display. The walking belt will then slow to a stop.

Note: Each time a segment ends and the speed settings move one column to the left, if all of the indicators in the Current Segment column are lit, the speed settings will move downward so that only the highest indicators in the columns will appear in the program display. When the speed settings move to the left again and not all of the indicators in the Current Segment column are lit, the speed settings will move back up.

If the speed or incline setting for the current segment is too high or too low, you can manually override the setting by pressing the Speed or Incline buttons on the console. Every few times one of the Speed buttons is pressed, an additional indicator will light or darken in the Current Segment column. If any of the columns to the right of the Current Segment column have the same number of lit indicators as the Current Segment column, an additional indicator will light or darken in those columns as well. Note: If you manually adjust the speed setting so that all of the indicators in the Current Segment column are lit, the speed settings in the program display will not move downward as described above. **When the current segment of the program ends, the treadmill will automatically adjust to the speed and incline settings for the next segment.**

To stop the program temporarily, press the Stop button. All displays will pause and the Time/Segment Time display will begin to flash. To restart the program, press the Start button or the Speed + button. To end the program, press the Stop button, remove the key, and then reinsert the key.

4 Use the hand weights, if desired.

If one of the three cross training programs is selected, the Cross Training Indicator below the Time/Segment Time display will periodically flash.

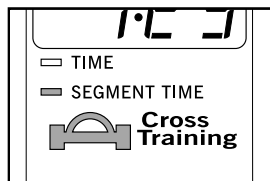

While the indicator is flashing, use the included hand weights for upper body exercise as you walk on the treadmill.

WARNING: Using hand weights and not holding the handrails may compromise your ability to maintain your balance. Exercises using hand weights should be attempted only by experienced users.

5 Follow your progress with the four displays.

Refer to step 5 on page 11.

6 When the program has ended, remove the key.

Step onto the foot rails and make sure that the incline of the treadmill is at the lowest setting. **The incline must be at the lowest setting when the treadmill is raised to the storage position.** Next, remove the key from the console and put it in a secure place. **Note: If the displays and indicators on the console remain lit after the key is removed, the console is in the “demo” mode. Refer to page 20 and turn off the demo mode.**

When you are finished using the treadmill, move the on/off switch near the power cord to the off position and unplug the power cord.

HOW TO USE THE PULSE PROGRAMS

WARNING: If you have heart problems, or if you are over 60 years of age and have been inactive, do not use the pulse programs. If you are taking medication regularly, consult your physician to find whether the medication will affect your exercise heart rate.

1 Insert the key into the console.

See HOW TO TURN ON THE POWER on page 10.

2 Put on the optional chest pulse sensor.

To use a pulse program, **you must wear the optional chest pulse sensor** (see page 20). To put on the chest pulse sensor, follow the instructions included with the chest pulse sensor.

3 Select one of the two pulse programs.

When the key is inserted, the manual mode will be selected. To select one of the pulse programs, press the Select Workout button repeatedly until one of the two pulse program indicators lights.

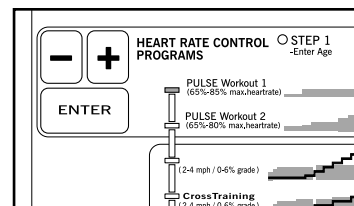

The profiles on the console show how the target heart rate will change during the programs. The program display will show a simplified profile of the program. The Time/Segment Time display will show how long the selected program will last.

4 Enter your age.

When a pulse program is selected, the word AGE will appear in the Pulse/Calories display.

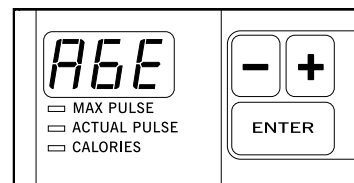

If you have already entered your age, simply press the Enter button. If you have not entered your age, press the + or – button. The current age setting will then appear in the display. Press the buttons again to enter your age. The buttons can be held down to enter your age quickly. When your age is shown, press the Enter button.

5 Enter a maximum heart rate setting.

After you have entered your age, the letters PLS will appear in the Pulse/Calories display.

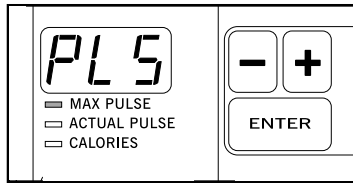

Press the + or – button. A number will then appear in the display. This number is the maximum heart rate setting for the program. If Pulse program 1 is selected, the maximum heart rate setting can be from 65% to 85% of your maximum possible heart rate; if Pulse program 2 is selected, the maximum heart rate setting can be from 65% to 80% of your maximum possible heart rate.

Note: Your maximum possible heart rate is estimated by subtracting your age from 220. For example, if you are 30 years old, your maximum possible heart rate is 190 beats per minute ($220 - 30 = 190$). Therefore, if Pulse program 1 is selected, the maximum heart rate setting can be from 123 to 161 beats per minute (65% of 190 is 123; 85% of 190 is 161).

If you want to change the maximum heart rate setting, press the + and – buttons. The buttons can be held down to change the setting quickly. When the desired setting is shown, press the Enter button.

6 Press the Start button or the Speed + button to start the program.

A moment after the button is pressed, the treadmill will automatically adjust to the first speed and incline settings for the program. Hold the handrails and begin walking.

Each program is divided into several time segments of different lengths. The Time/Segment Time display will show both the time remaining in the program and the time remaining in the current segment. One target heart rate setting is programmed for each segment. The heart rate setting for the first segment will be shown in the flashing Current Segment column of the program display. The heart rate settings for the next five segments will be shown in the five columns to the right.

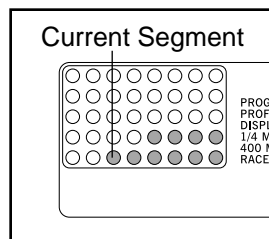

When only three seconds remain in the first segment of the program, both the Current Segment column and the column to the right will flash, a series of tones will sound, and the Speed display and the Distance/Incline display will flash. When the first segment is completed, all heart rate settings will move one column to the left. The heart rate setting for the second segment will then be shown in the flashing Current Segment column, and the speed and/or incline of the treadmill will change, if needed, to bring your heart rate closer to the heart rate setting for the second segment.

The program will continue until no time remains in the Time/Segment Time display. The walking belt will then slow to a stop.

If the speed or incline setting for the current segment is too high or too low, you can adjust the setting with the Speed or Incline buttons. However, if you decrease the speed, the incline will automatically increase; if you increase the speed, the incline will decrease. If you increase the incline, the speed will decrease; if you decrease the incline, the speed will increase. The treadmill will always attempt to keep your heart rate near the target heart rate setting for the current segment. Note: When the incline reaches the lowest setting, the speed cannot be increased any further. When the incline reaches the highest setting, the speed cannot be decreased any further.

If your pulse is not detected during the program, the letters PLS will flash in the Pulse/Calories display. In addition, the speed and/or incline of the treadmill may automatically decrease until your pulse is detected. If this occurs, refer to the instructions included with the chest pulse sensor.

Pulse programs cannot be stopped temporarily and then restarted. To stop the program at any time, press the Stop button.

7 Follow your progress with the four displays.

Refer to step 5 on page 11.

8 When the program has ended, remove the key.

See step 6 on page 13.

HOW TO CONNECT THE TREADMILL TO YOUR CD PLAYER, VCR, OR COMPUTER

To use **iFIT.com CDs**, the treadmill must be connected to your portable CD player, portable stereo, home stereo, or computer with CD player. See pages 15 and 16 for connecting instructions. To use **iFIT.com videocassettes**, the treadmill must be connected to your VCR. See page 17 for connecting instructions. To use **iFIT.com programs directly from our Web site**, the treadmill must be connected to your home computer. See page 16 for connecting instructions.

HOW TO CONNECT YOUR PORTABLE CD PLAYER

Note: If your CD player has separate **LINE OUT** and **PHONES** jacks, see instruction A below. If your CD player has only one jack, see instruction B.

- A. Plug one end of the audio cable into the jack on the front of the treadmill near the power cord. Plug the other end of the cable into the **LINE OUT** jack on your CD player. Plug your headphones into the **PHONES** jack.

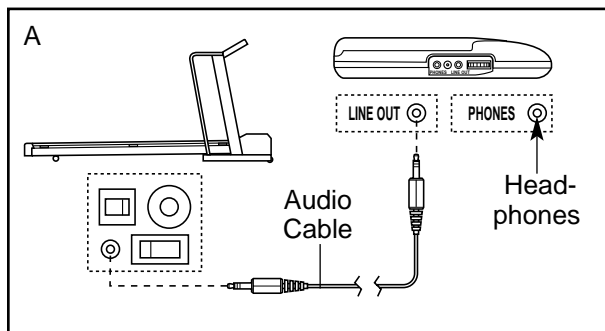

- B. Plug one end of the audio cable into the jack on the front of the treadmill near the power cord. Plug the other end of the cable into a 3.5mm Y-adaptor (available at electronics stores). Plug the Y-adaptor into the **PHONES** jack on your CD player. Plug your headphones into the other side of the Y-adaptor.

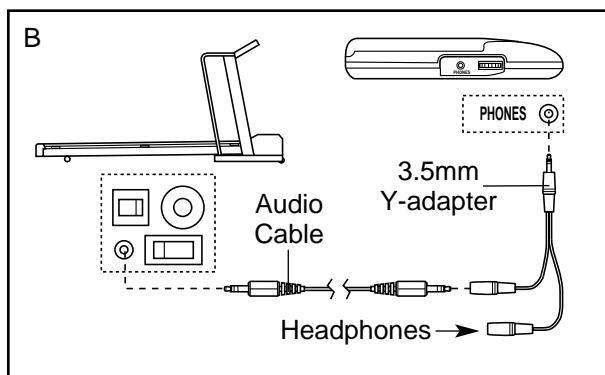

HOW TO CONNECT YOUR PORTABLE STEREO

Note: If your stereo has an **RCA-type AUDIO OUT** jack, see instruction A below. If your stereo has a **3.5mm LINE OUT** jack, see instruction B. If your stereo has only a **PHONES** jack, see instruction C.

- A. Plug one end of the audio cable into the jack on the front of the treadmill near the power cord. Plug the other end of the cable into the included adaptor. Plug the adaptor into an **AUDIO OUT** jack on your stereo.

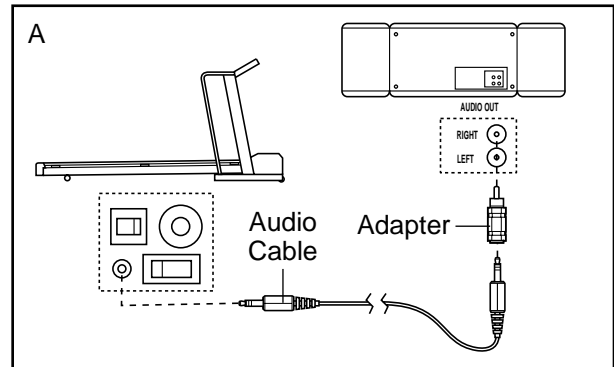

- B. Plug one end of the audio cable into the jack on the front of the treadmill near the power cord. Plug the other end of the cable into the **LINE OUT** jack on your stereo.

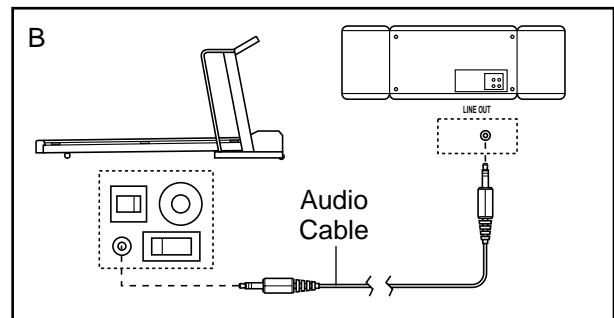

- C. Plug one end of the audio cable into the jack on the front of the treadmill near the power cord. Plug the other end of the cable into a 3.5mm Y-adaptor (available at electronics stores). Plug the Y-adaptor into the **PHONES** jack on your stereo. Plug your headphones into the other side of the Y-adaptor.

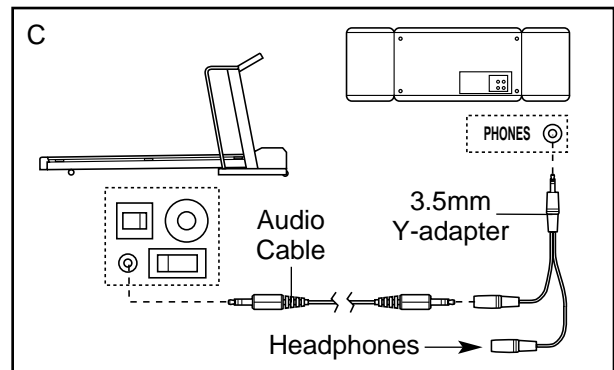

HOW TO CONNECT YOUR HOME STEREO

Note: If your stereo has an unused **LINE OUT** jack, see instruction **A** below. If the **LINE OUT** jack is being used, see instruction **B**.

- A. Plug one end of the audio cable into the jack on the front of the treadmill near the power cord. Plug the other end of the cable into the included adapter. Plug the adapter into the **LINE OUT** jack on your stereo.

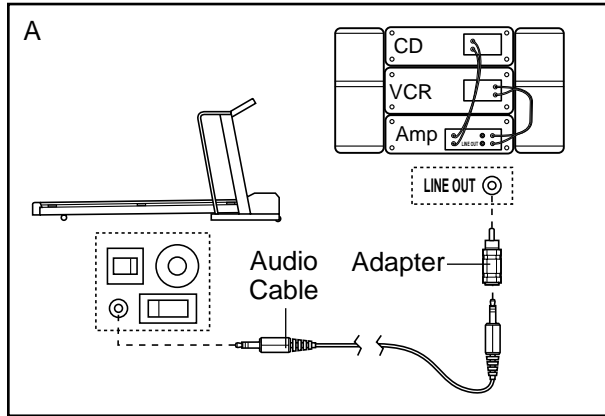

- B. Plug one end of the audio cable into the jack on the front of the treadmill near the power cord. Plug the other end of the cable into the included adapter. Plug the adapter into an **RCA Y-adapter** (available at electronics stores). Next, remove the wire that is currently plugged into the **LINE OUT** jack on your stereo and plug the wire into the unused side of the **Y-adapter**. Plug the **Y-adapter** into the **LINE OUT** jack on your stereo.

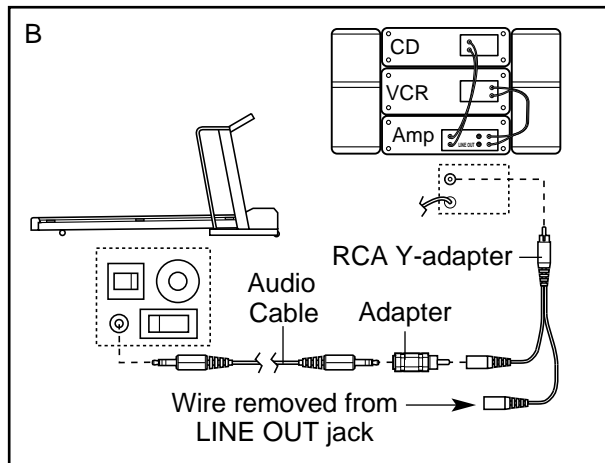

HOW TO CONNECT YOUR COMPUTER

Note: If your computer has a **3.5mm LINE OUT** jack, see instruction **A**. If your computer has only a **PHONES** jack, see instruction **B**.

- A. Plug one end of the audio cable into the jack on the front of the treadmill near the power cord. Plug the other end of the cable into the **LINE OUT** jack on your computer.

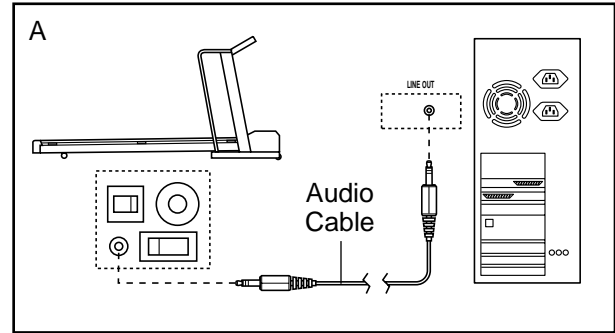

- B. Plug one end of the audio cable into the jack on the front of the treadmill near the power cord. Plug the other end of the cable into a **3.5mm Y-adapter** (available at electronics stores). Plug the **Y-adapter** into the **PHONES** jack on your computer. Plug your headphones or speakers into the other side of the **Y-adapter**.

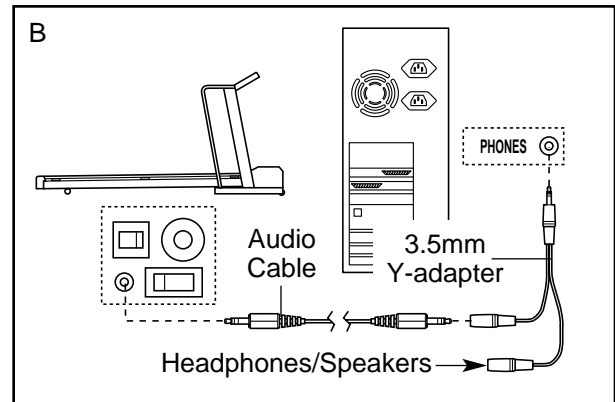

HOW TO CONNECT YOUR VCR

Note: If your VCR has an unused AUDIO OUT jack, see instruction A below. If the AUDIO OUT jack is being used, see instruction B. If you have a TV with a built-in VCR, see instruction B. If your VCR is connected to your home stereo, see **HOW TO CONNECT YOUR HOME STEREO** on page 16.

- A. Plug one end of the audio cable into the jack on the front of the treadmill near the power cord. Plug the other end of the cable into the included adapter. Plug the adapter into the AUDIO OUT jack on your VCR.

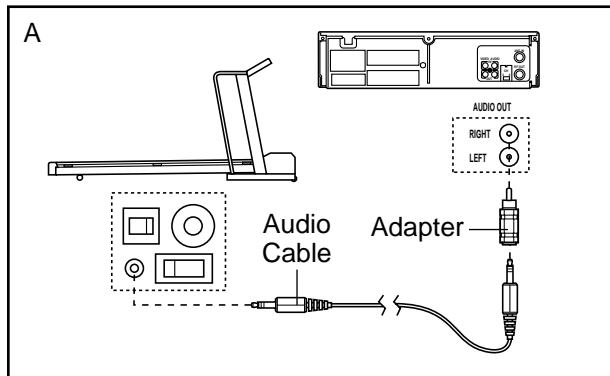

- B. Plug one end of the audio cable into the jack on the front of the treadmill near the power cord. Plug the other end of the cable into the included adapter. Plug the adapter into an RCA Y-adapter (available at electronics stores). Next, remove the wire that is currently plugged into the AUDIO OUT jack on your VCR and plug the wire into the unused side of the Y-adapter. Plug the Y-adapter into the AUDIO OUT jack on your VCR.

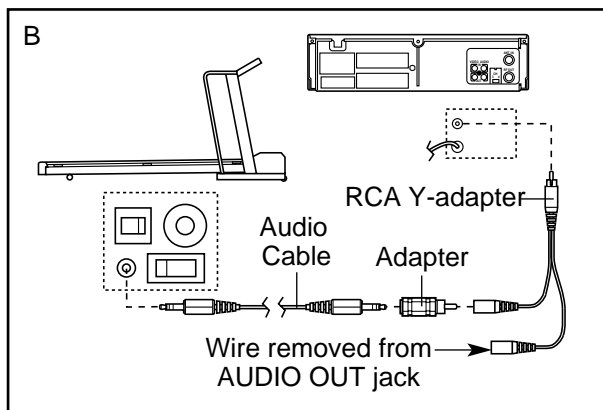

HOW TO USE iFIT.COM CD AND VIDEO PROGRAMS

To use iFIT.com CDs or videocassettes, the treadmill must be connected to your portable CD player, portable stereo, home stereo, computer with CD player, or VCR. See **HOW TO CONNECT THE TREADMILL TO YOUR CD PLAYER, VCR, OR COMPUTER** on page 15. **Note:** To purchase iFIT.com CDs or iFIT.com videocassettes, call toll-free 1-800-735-0768.

Follow the steps below to use an iFIT.com CD or video program.

1 Insert the key into the console.

See **HOW TO TURN ON THE POWER** on page 10.

2 Select the iFIT.com mode.

When the key is inserted, the manual mode will be selected. To use iFIT.com CDs or videocassettes, press the iFIT.com button. The iFIT.com indicator will light.

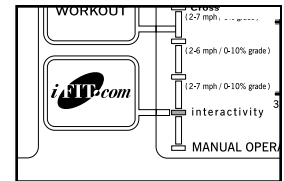

3 Insert the iFIT.com CD or videocassette.

If you are using an iFIT.com CD, insert the CD into your CD player. If you are using an iFIT.com videocassette, insert the videocassette into your VCR.

4 Press the PLAY button on your CD player or VCR.

A moment after the button is pressed, your personal trainer will begin guiding you through your workout. Simply follow your personal trainer's instructions. Note: If the Time/Segment Time display is flashing, press the Start button or the Speed + button on the console. The treadmill will not respond to a CD or video program when the Time/Segment Time display is flashing.

During the CD or video program, an electronic "chirping" sound will alert you when the speed and/or incline of the treadmill is about to change. **CAUTION: Always listen for the "chirp" and be prepared for speed and/or incline changes. In some instances, the speed and/or incline may change before the personal trainer describes the change.**

If the speed or incline settings are too high or too low, you can manually override the settings at any time by pressing the Speed or Incline buttons on the console. However, **when the next “chirp” is heard, the speed and/or incline will change to the next settings of the CD or video program.**

To stop the walking belt at any time, press the Stop button on the console. The Time/Segment Time display will begin to flash. To restart the program, press the Start button or the Speed + button. After a moment, the walking belt will begin to move at 1 mph. **When the next “chirp” is heard, the speed and incline will change to the next settings of the CD or video program.** The program can also be stopped by pressing the Stop button on your CD player or VCR.

When the CD or video program is completed, the walking belt will stop and the Time/Segment Time display will begin to flash. Note: To use another CD or video program, press the Stop button or remove the key and go to step 1 on page 17.

Note: If the speed or incline of the treadmill does not change when a “chirp” is heard:

- **Make sure that the iFIT.com indicator is lit and that the Time/Segment Time display is not flashing. If the Time/Segment Time display is flashing, press the Start button or the Speed + button on the console.**

- **Adjust the volume of your CD player or VCR. If the volume is too high or too low, the console may not detect the program signals.**
- **Make sure that the audio cable is properly connected, that it is fully plugged in, and that it is not wrapped around a power cord.**
- **If you are using your portable CD player and the CD skips, set the CD player on the floor or another flat surface instead of on the console.**

5 Follow your progress with the four displays.

See step 5 on page 11.

6 When the program is completed, remove the key.

See step 6 on page 13.

CAUTION: Always remove iFIT.com CDs and videos from your CD player or VCR when you are not using them.

HOW TO USE PROGRAMS DIRECTLY FROM OUR WEB SITE

Our Web site at www.iFIT.com allows you to access basic programs, audio programs, and video programs directly from the internet. Additional options, such as on-line competitions, personal training sessions via the internet, and online tracking of your workout history are soon to be available. See www.iFIT.com for details.

To use programs from our Web site, the treadmill must be connected to your home computer. See HOW TO CONNECT YOUR COMPUTER on page 16. In addition, you must have an internet connection and an internet service provider. A list of specific system requirements will be found on our Web site.

Follow the steps below to use a program from our Web site.

1 Insert the key into the console.

See HOW TO TURN ON THE POWER on page 10.

2 Select the iFIT.com mode.

When the key is inserted, the manual mode will be selected. To use a program from our Web site, press the iFIT.com button. The iFIT.com indicator will light.

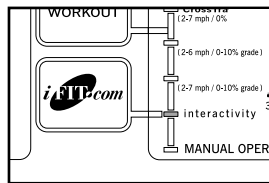

3 Go to your computer and start an internet connection.

4 Start your web browser, if necessary, and go to our Web site at www.iFIT.com.

5 Follow the desired links on our Web site to select a program.

Read and follow the on-line instructions for using a program.

6 Follow the on-line instructions to start the program.

When you start the program, an on-screen countdown will begin.

7 Return to the treadmill and stand on the foot rails. Find the clip attached to the key and slide the clip onto the waistband of your clothes.

When the on-screen countdown ends, the program will begin and the walking belt will begin to move. Hold the handrails, step onto the walking belt, and begin walking. During the program, an electronic “chirping” sound will alert you when the speed and/or incline of the treadmill is about to change. **CAUTION: Always listen for the “chirp” and be prepared for speed and/or incline changes.**

If the speed or incline settings are too high or too low, you can manually override the settings at any time by pressing the Speed or Incline buttons on the console. **However, when the next “chirp” is heard, the speed and/or incline will change to the next settings for the program.**

To stop the walking belt at any time, press the Stop button on the console. The Time/Segment Time display will begin to flash. To restart the program, press the Start button or the Speed + button. After a moment, the walking belt will begin to move at 1 mph. **When the next “chirp” is heard, the speed and incline will change to the next settings for the program.**

When the program is completed, the walking belt will stop and the Time/Segment Time display will begin to flash. Note: To use another program, press the Stop button and go to step 5.

Note: If the speed or incline of the treadmill does not change when a “chirp” is heard, make sure that the iFIT.com indicator is lit and that the Time/Segment Time display is not flashing. In addition, make sure that the audio cable is properly connected, that it is fully plugged in, and that it is not wrapped around a power cord.

8 Follow your progress with the four displays.

See step 5 on page 11.

9 When the program has ended, remove the key.

See step 6 on page 13.

THE INFORMATION MODE/DEMO MODE

The console features an information mode that keeps track of the total number of hours that the treadmill has been operated and the total number of miles that the walking belt has moved. The information mode also allows you to switch the console from miles per hour to kilometers per hour. In addition, the information mode allows you to turn on and turn off the demo mode.

To select the information mode, hold down the Stop button while inserting the key into the console. When the information mode is selected, the following information will be shown:

The Time/Segment Time display will show the total number of hours that the treadmill has been used.

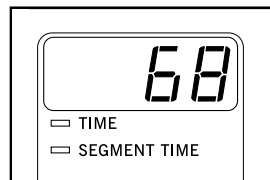

The Distance/Incline display will show the total number of miles that the walking belt has moved.

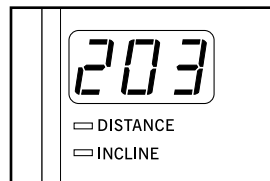

An E for English miles or an M for metric kilometers will appear in the Speed display. Press the Speed + button to change the unit of measurement.

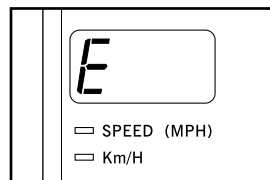

IMPORTANT: The Pulse/Calories display should be blank. If a "d" appears in the display, the console is in the "demo" mode. This mode is intended to be used only

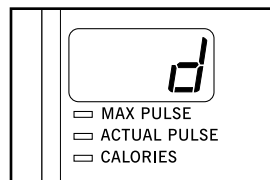

when a treadmill is displayed in a store. When the console is in the demo mode, the power cord can be plugged in, the key can be removed from the console, and the displays and indicators on the console will automatically light in a preset sequence, although the buttons on the console will not operate. **If a "d" appears in the Pulse/Calories display when the information mode is selected, press the Speed – button so the Pulse/Calories display is blank.**

To exit the information mode, remove the key from the console.

THE OPTIONAL CHEST PULSE SENSOR

An optional chest pulse sensor adds even more features to the console. The chest pulse sensor continuously monitors your heart rate during your workouts and allows you to use the console's two pulse programs. **To purchase the optional chest pulse sensor, call toll-free 1-800-734-2377.**

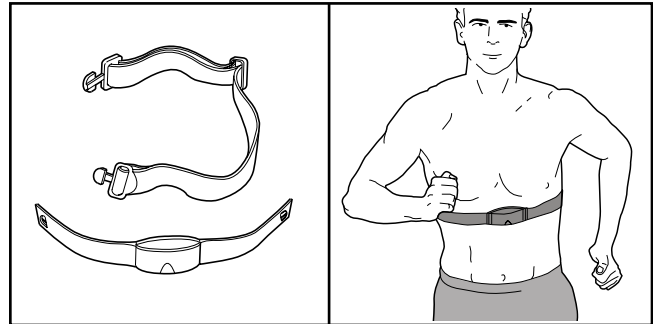

HOW TO FOLD AND MOVE THE TREADMILL

HOW TO FOLD THE TREADMILL FOR STORAGE

Before folding the treadmill, adjust the incline to the lowest position. If this is not done, the treadmill may be permanently damaged. Next, unplug the power cord. **CAUTION:** You must be able to safely lift 45 pounds (20 kg) to raise, lower, or move the treadmill.

1. Hold the treadmill in the locations shown at the right. **To decrease the possibility of injury, bend your legs and keep your back straight. As you raise the treadmill, make sure to lift with your legs rather than your back.** Raise the treadmill about halfway to the vertical position.

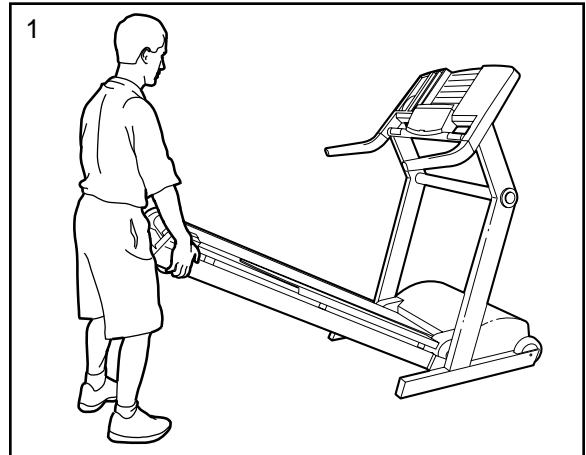

2. Move your right hand to the position shown and hold the treadmill firmly. Using your left hand, pull the lock knob to the left and hold it. Raise the treadmill until all parts of the treadmill are past the latch pin. Then, release the lock knob. **Make sure that the lock knob is fully released so that the latch pin is securely holding the catch.**

To protect the floor or carpet from damage, place a mat under the treadmill. Keep the treadmill out of direct sunlight. Do not leave the treadmill in the storage position in temperatures above 85° Fahrenheit.

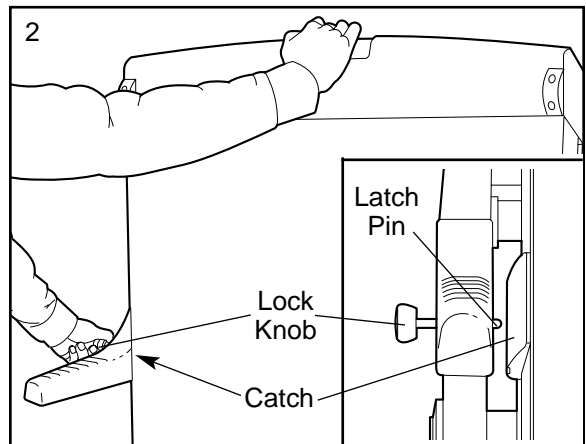

HOW TO MOVE THE TREADMILL

Before moving the treadmill, convert the treadmill to the storage position as described above. **Make sure that the latch pin is securely holding the catch.**

1. Hold the handrails and place one foot on the base.
2. Tilt the treadmill back until it rolls freely on the wheels. Carefully move the treadmill to the desired location. **To reduce the risk of injury, use extreme caution while moving the treadmill. Do not attempt to move the treadmill over an uneven surface.**
3. Place one foot on the wheel, and carefully lower the treadmill until the base is resting in the storage position.

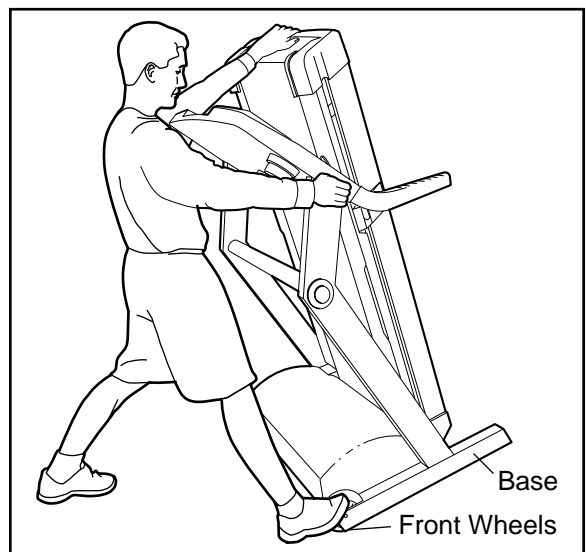

HOW TO LOWER THE TREADMILL FOR USE

1. Refer to drawing 2 above. Hold the treadmill as shown, and pull the lock knob to the left. Pivot the treadmill down until the frame and the foot rails are past the latch pin. Slowly release the lock knob.
2. Refer to drawing 1 above. Hold the treadmill firmly with both hands, and lower the treadmill to the floor. **To decrease the possibility of injury, bend your legs and keep your back straight.**

TROUBLE-SHOOTING

Most treadmill problems can be solved by following the instructions below. If further assistance is needed, please call our Customer Service Department toll-free at 1-800-999-3756, Monday through Friday, 6 a.m. until 6 p.m. Mountain Time (excluding holidays).

PROBLEM

SOLUTION

1. The power does not turn on

a. Make sure that the power cord is plugged into a surge suppressor, and that the surge suppressor is plugged into a properly grounded outlet (see page 7). Use only a single-outlet surge suppressor that meets all of the specifications described on page 7. Important: The treadmill is not compatible with GFCI-equipped outlets.

b. Make sure that the key is fully inserted into the console.

c. Check the circuit breaker located on the frame near the power cord. If the switch protrudes as shown, the circuit breaker has tripped. To reset the circuit breaker, wait for five minutes and then press the switch back in.

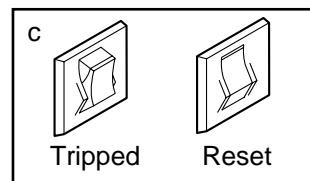

d. Check the on/off switch located on the frame near the power cord. The switch must be in the on position.

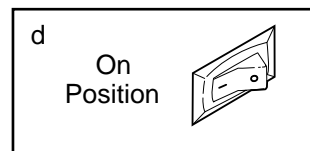

2. The power turns off during use

a. Check the circuit breaker located on the treadmill frame near the power cord (see 1. c. above). If the circuit breaker has tripped, wait for five minutes and then press the switch back in.

b. Make sure that the power cord is plugged in.

c. Remove the key from the console and then reinsert it.

d. Make sure that the on/off switch is in the on position (see 1. d. above).

3. The walking belt slows when walked on

a. Use only a single-outlet surge suppressor that meets all of the specifications described on page 7.

b. If the walking belt is overtightened, treadmill performance may decrease and the walking belt may be permanently damaged. Remove the key and **UNPLUG THE POWER CORD**. Using the included allen wrench, turn both rear roller adjustment bolts counterclockwise 1/4 of a turn. When the walking belt is properly tightened, you should be able to lift **the edges** of the walking belt 3 to 4 inches off the walking platform. Be careful to keep the walking belt centered. Plug in the power cord, insert the key and run the treadmill for a few minutes. Repeat until the walking belt is properly tightened.

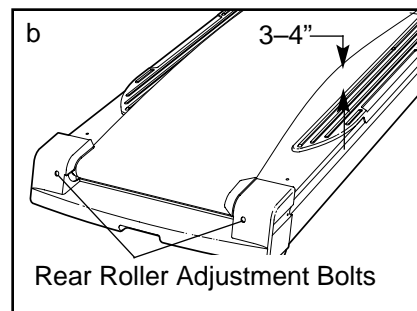

PROBLEM

SOLUTION

4. The walking belt is off-center or slips when walked on

a. If the walking belt is off-center, first remove the key and **UNPLUG THE POWER CORD**. If the walking belt has shifted to the left, use the allen wrench to turn the left rear roller bolt clockwise 1/2 of a turn; if the walking belt has shifted to the right, turn the bolt counterclockwise 1/2 of a turn. Be careful not to overtighten the walking belt. Plug in the power cord, insert the key and run the treadmill for a few minutes. Repeat until the walking belt is centered.

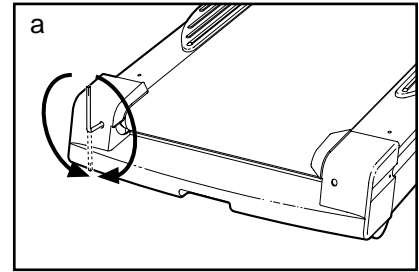

b. If the walking belt slips when walked on, first remove the key and **UNPLUG THE POWER CORD**. Using the allen wrench, turn both rear roller bolts clockwise 1/4 of a turn. When the walking belt is correctly tightened, you should be able to lift each side of the walking belt 3 to 4 inches off the walking platform. Be careful to keep the walking belt centered. Plug in the power cord, insert the key and carefully walk on the treadmill for a few minutes. Repeat until the walking belt is properly tightened.

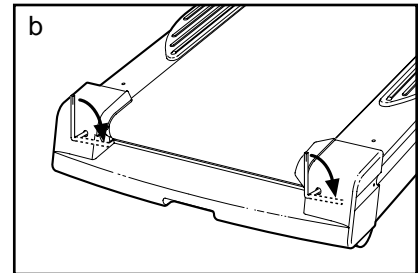

5. The displays of the console do not function properly

a. Remove the key from the console and **UNPLUG THE POWER CORD**. Next, remove the screws from the hood and carefully remove the hood. Locate the Reed Switch (17) and the Magnet (12) on the left side of the Pulley (11). Turn the Pulley until the Magnet is aligned with the Reed Switch. **Make sure that the gap between the Magnet and the Reed Switch is about 1/8"**. If necessary, loosen the Screw (99) and move the Reed Switch slightly. Retighten the Screw. Re-attach the hood and run the treadmill for a few minutes to check for a correct speed reading.

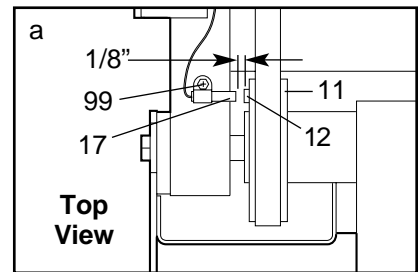

EXERCISE GUIDELINES

⚠️ WARNING: Before beginning this or any exercise program, consult your physician. This is especially important for individuals over the age of 35 or individuals with pre-existing health problems.

The pulse sensor is not a medical device. Various factors, including your movement, may affect the accuracy of heart rate readings. The sensor is intended only as an exercise aid in determining heart rate trends in general.

The following guidelines will help you to plan your exercise program. For more detailed exercise information, obtain a reputable book or consult your physician.

EXERCISE INTENSITY

Whether your goal is to burn fat or to strengthen your cardiovascular system, the key to achieving the desired results is to exercise with the proper intensity. The proper intensity level can be found by using your heart rate as a guide. The chart below shows recommended heart rates for fat burning and aerobic exercise.

HEART RATE TRAINING ZONES							
AEROBIC	165	155	145	140	130	125	115
MAX FAT BURN	145	138	130	125	118	110	103
FAT BURN	125	120	115	110	105	95	90
Age	20	30	40	50	60	70	80

To find the proper heart rate for you, first find your age near the bottom of the chart (ages are rounded off to the nearest ten years). Next, find the three numbers above your age. The three numbers define your “training zone.” The lower two numbers are recommended heart rates for fat burning; the highest number is the recommended heart rate for aerobic exercise.

To measure your heart rate during exercise, use the handgrip pulse sensor or the optional chest pulse sensor (see page 20). If your heart rate is too high or too low, adjust the speed or incline of the treadmill.

Fat Burning

To burn fat effectively, you must exercise at a relatively low intensity level for a sustained period of time. During the first few minutes of exercise, your body uses easily accessible carbohydrate calories for en-

ergy. Only after the first few minutes does your body begin to use stored fat calories for energy. If your goal is to burn fat, adjust the speed or incline of the treadmill until your heart rate is near the lowest number in your training zone.

For maximum fat burning, adjust the speed or incline of the treadmill until your heart rate is near the middle number in your training zone.

Aerobic Exercise

If your goal is to strengthen your cardiovascular system, your exercise must be “aerobic.” Aerobic exercise is activity that requires large amounts of oxygen for prolonged periods of time. This increases the demand on the heart to pump blood to the muscles, and on the lungs to oxygenate the blood. For aerobic exercise, adjust the speed or incline of the treadmill until your heart rate is near the highest number in your training zone.

WORKOUT GUIDELINES

Each workout should include the following three parts:

A Warm-up—Start each workout with 5 to 10 minutes of stretching and light exercise. A proper warm-up increases your body temperature, heart rate and circulation in preparation for exercise.

Training Zone Exercise—After warming up, increase the intensity of your exercise until your pulse is in your training zone for 20 to 60 minutes. (During the first few weeks of your exercise program, do not keep your pulse in your training zone for longer than 20 minutes.) Breathe regularly and deeply as you exercise—never hold your breath.

A Cool-down—Finish each workout with 5 to 10 minutes of stretching to cool down. This will increase the flexibility of your muscles and will help prevent post-exercise problems.

EXERCISE FREQUENCY

To maintain or improve your condition, complete three workouts each week, with at least one day of rest between workouts. After a few months, you may complete up to five workouts each week if desired.

The key to success is to make exercise a regular and enjoyable part of your everyday life.

PART LIST—Model No. PFTL09911

R0402A

To locate the parts listed below, refer to the EXPLODED DRAWING attached in the center of this manual.

Key No.	Qty.	Description	Key No.	Qty.	Description
1	1	Left Foot Rail	50	4	Isolator Nut
2	1	Right Foot Rail	51	1	Filter Wire
3*	1	Motor Assembly	52	2	Roller Adj. Washer
4	4	Isolator	53	2	Rear Roller Adj. Bolt
5	1	Latch Catch	54	1	Rear Endcap
6	1	Platform	55	1	Frame
7	4	Walking Deck Screw	56	1	Allen Wrench
8	1	Walking Belt	57	2	Rear Platform Screw
9	2	Frame Pivot Bolt	58	1	Rear Roller
10	1	Latch Assembly	59	1	Pulse Wire Harness
11	1	Front Roller/Pulley	60	2	Frame Star Washer
12	1	Magnet	61	1	Book Rack
13	7	Front Wheel Nut/Pivot Nut	62	1	Left Foam Grip
14	2	Spacer Insert	63	2	Handrail Endcap
15	2	Frame Pivot Spacer	64	1	Audio Wire Nut
16	1	Reed Switch Clip	65	1	Upright
17	1	Reed Switch	66	4	Base Mounting Screw
18	1	Lift Frame	67	1	Lock Knob
19	4	Frame Pivot Washer	68	2	Outlet Bracket Star Washer
20	1	Motor Tension Nut	69	1	Lock Knob Spring
21	2	Pulse Bar Bolt	70	1	Lock Pin Collar
22	1	Motor Belt	71	1	Pin Clip
23	1	Motor Tension Washer	72	1	Lock Pin
24	1	Motor	73	2	Incline Pivot Bolt
25	1	Pulley Spacer	74	1	Wire Harness Grommet
26	2	Static Warning Decal	75	8	Console Screw
27	4	Hood Bracket	76	4	Controller Screw
28	1	Flywheel/Pulley	77	2	Front Wheel
29	1	Motor Pivot Bolt	78	2	Wheel Bolt
30	2	Lift Motor Nut	79	1	Right Foam Grip
31	1	Lift Motor Bolt	80	1	Console Base (Top)
32	1	Motor Tension Bolt	81	1	Console
33	1	Outlet Bracket	82	1	Key/Clip
34	4	Plastic Stand-off	83	1	Console Base (Bottom)
35	1	Power Supply	84	1	Pulse Sensor Plate
36	1	Power Supply Bracket	85	1	Upright Wire Harness
37	1	Controller	86	1	Shock
38	1	Controller Bracket	87	2	Upright Endcap
39	1	Motor Hood	88	4	Wheel Washer
40	6	Latch Catch Screw/Rear Endcap Screw	89	1	Pulse Sensor Cover
41	1	Motor Belly Pan	90	1	Latch Warning Decal
42	2	Belt Guide	91	1	Incline Motor
43	21	Misc. Screw	92	1	Controller Wire
44	13	Plastic Fastener	93	1	Lift Motor Bolt
45	1	Frame Belly Pan	94	6	Sensor Cover Screw/Rear Foot Screw
46	1	Pulse Bar	95	1	Tie Holder
47	1	Ground Wire	96	2	Tie
48	2	Rear Foot	97	5	8" Cable Tie
49	2	Roller Star Washer	98	4	Bumper

SUGGESTED STRETCHES

The correct form for several basic stretches is shown at the right. Move slowly as you stretch—never bounce.

1. Toe Touch Stretch

Stand with your knees bent slightly and slowly bend forward from your hips. Allow your back and shoulders to relax as you reach down toward your toes as far as possible. Hold for 15 counts, then relax. Repeat 3 times. Stretches: Hamstrings, back of knees and back.

2. Hamstring Stretch

Sit with one leg extended. Bring the sole of the opposite foot toward you and rest it against the inner thigh of your extended leg. Reach toward your toes as far as possible. Hold for 15 counts, then relax. Repeat 3 times for each leg. Stretches: Hamstrings, lower back and groin.

3. Calf/Achilles Stretch

With one leg in front of the other, reach forward and place your hands against a wall. Keep your back leg straight and your back foot flat on the floor. Bend your front leg, lean forward and move your hips toward the wall. Hold for 15 counts, then relax. Repeat 3 times for each leg. To cause further stretching of the achilles tendons, bend your back leg as well. Stretches: Calves, achilles tendons and ankles.

4. Quadriceps Stretch

With one hand against a wall for balance, reach back and grasp one foot with your other hand. Bring your heel as close to your buttocks as possible. Hold for 15 counts, then relax. Repeat 3 times for each leg. Stretches: Quadriceps and hip muscles.

5. Inner Thigh Stretch

Sit with the soles of your feet together and your knees outward. Pull your feet toward your groin area as far as possible. Hold for 15 counts, then relax. Repeat 3 times. Stretches: Quadriceps and hip muscles.

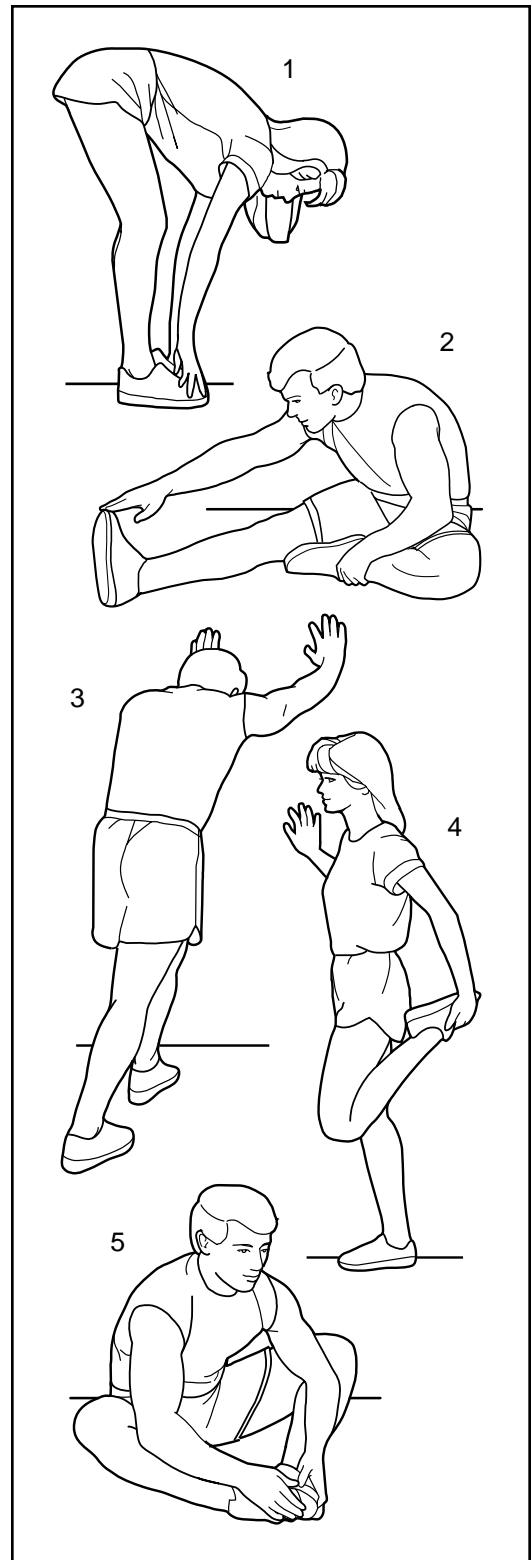

Key No.	Qty.	Description
99	4	Bumper Screw
100	1	On/Off Switch
101	1	Circuit Breaker
102	1	Power Cord
103	1	Power Cord Grommet
104	2	Warning Decal
105	26	Screw
106	1	Jack
107	1	iFIT.com Audio Cable
108	5	Hood Screw
109	2	2-pound Weight
110	2	Foam Pad
111	1	12" Audio Wire
112	3	Long Console Screw
113	4	Front Belly Pan Screw

Key No.	Qty.	Description
114	1	Motor Star Washer
115	1	Console Ground Wire
#	1	8" Blue Wire, M/F
#	1	8" Blue Wire, 2 F
#	1	4" Blue Wire, M/F
#	1	8" Black Wire, M/F
#	1	4" Black Wire, 2 F
#	1	14" White Wire, 2 F
#	1	8" Red Wire, M/F
#	1	8" Green Wire, 2 Ring
#	1	User's Manual

* Includes all parts shown in the box

These parts are not illustrated

ORDERING REPLACEMENT PARTS

To order replacement parts, call our Customer Service Department toll-free at 1-800-999-3756, Monday through Friday, 6 a.m. until 6 p.m. Mountain Time (excluding holidays). When ordering parts, please be prepared to give the following information:

- The MODEL NUMBER of the product (PFTL09911)
- The NAME of the product (PROFORM® CT 1160 treadmill)
- The SERIAL NUMBER of the product (see the front cover of this manual)
- The KEY NUMBER and DESCRIPTION of the part(s) (see the PART LIST on pages 26 and 27).

LIMITED WARRANTY

ICON Health & Fitness, Inc. (ICON), warrants this product to be free from defects in workmanship and material, under normal use and service conditions, for a period of ninety (90) days from the date of purchase. This warranty extends only to the original purchaser. ICON's obligation under this warranty is limited to replacing or repairing, at ICON's option, the product through one of its authorized service centers. All repairs for which warranty claims are made must be pre-authorized by ICON. This warranty does not extend to any product or damage to a product caused by or attributable to freight damage, abuse, misuse, improper or abnormal usage or repairs not provided by an ICON authorized service center; products used for commercial or rental purposes; or products used as store display models. No other warranty beyond that specifically set forth above is authorized by ICON.

ICON is not responsible or liable for indirect, special or consequential damages arising out of or in connection with the use or performance of the product or damages with respect to any economic loss, loss of property, loss of revenues or profits, loss of enjoyment or use, costs of removal or installation or other consequential damages of whatsoever nature. Some states do not allow the exclusion or limitation of incidental or consequential damages. Accordingly, the above limitation may not apply to you.

The warranty extended hereunder is in lieu of any and all other warranties and any implied warranties of merchantability or fitness for a particular purpose is limited in its scope and duration to the terms set forth herein. Some states do not allow limitations on how long an implied warranty lasts. Accordingly, the above limitation may not apply to you.

This warranty gives you specific legal rights. You may also have other rights which vary from state to state.

ICON HEALTH & FITNESS, INC., 1500 S. 1000 W., LOGAN, UT 84321-9813

EXPLODED DRAWING—Model No. PFTL09911

R0402A

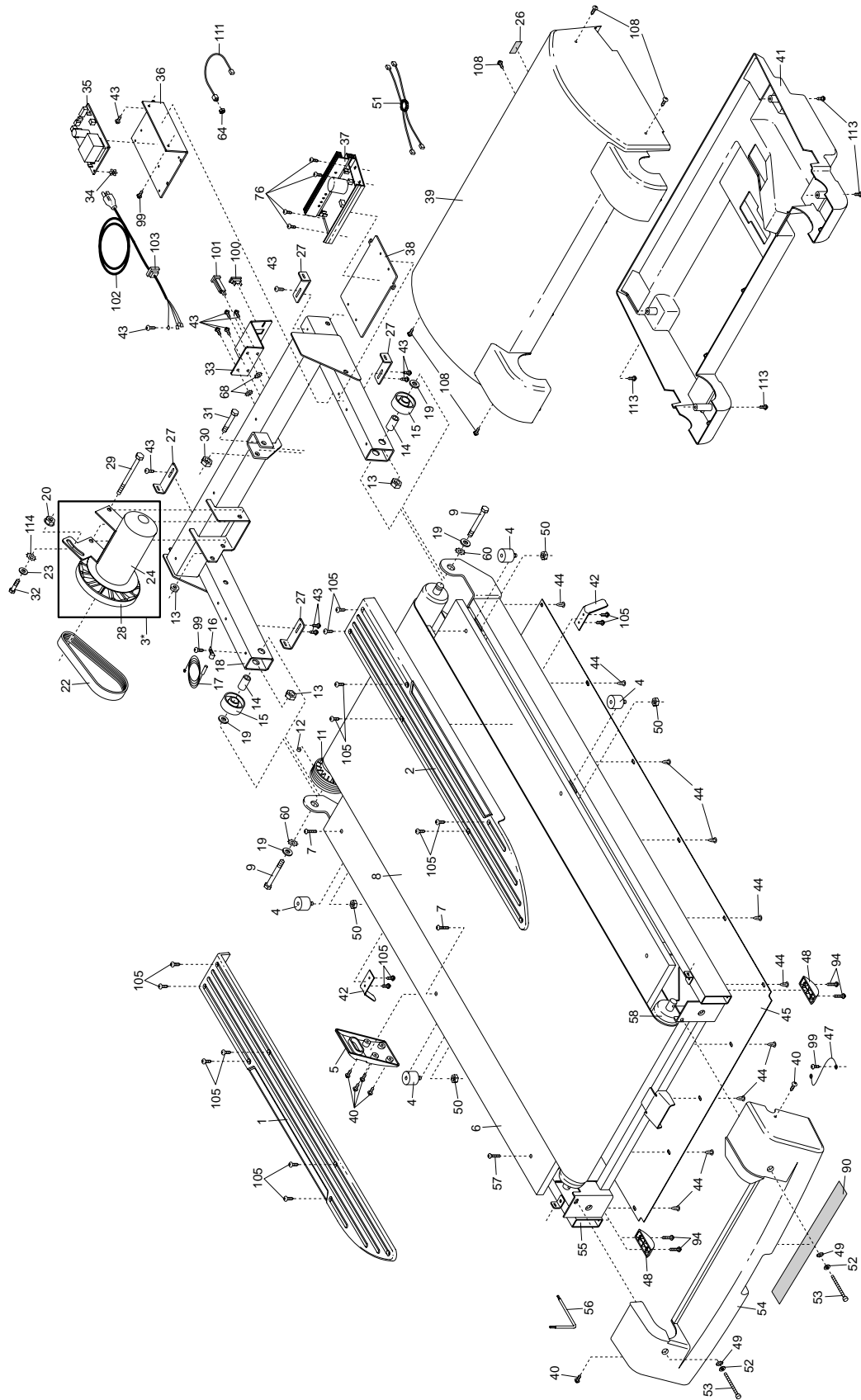

EXPLODED DRAWING—Model No. PFTL09911

R0402A

