



DISCOVERY 120 TREADMILL OWNER'S MANUAL

Model Name DCV120

Serial Number _____

Purchase Date _____

Write down for future reference.

Keys Technical Service, (888) 340-0482

KEYS Fitness Products, LP

P.O. Box 551239

Dallas, TX 75239-1239

Part# 15-0144



Table of Contents

Information	Page#
Table of Contents	2
Specification Sheet	3
Important Safety Information	4
Before You Start	5
Warm Up Exercises	6
Assembly, Moving Instructions	7
Power Requirements	8
Console Functions and Descriptions	9
Program and Operating Instructions	10 & 11
Program Descriptions and Profiles	12
Belt Adjustments and Tension	13
Change to MPH or Km/H	14
Maintenance Instructions	15
Troubleshooting Guide	16
Error Messages	17
Calibration Sequence	18
Parts and Diagrams	19
Warranty Registration (Mail In Form)	20



Specification Sheet

Horsepower (Peak)	3.5hp
Horsepower (Continuous)	1.75hp
Display Type	4 Window LCD
Electronics	Push button
Pre-Set Programs	3
Custom Programs	6
Speed/Incline Toggle Switches	Yes
Power Incline	0-12%
Roller Diameter	1.9"
Cushioned Deck	Yes
Speed Range	.6-10mph
Belt Size	18 x 51"
Side Hand Rails	Yes
Foot Print	29 x 62"
Folded Foot Print	29 x 29"
Warranty Motor	10 Years
Warranty Parts	1 Year
Warranty Labor	90 Days
Warranty Frame	Lifetime

Important Safety Information

WARNING! Before using this treadmill or starting any exercise program, consult your physician. This is especially important for persons over the age of 35 and/or persons with pre-existing health problems. The manufacturer or distributor assumes no responsibility for personal injury or property damage sustained by or through the use of this product.

WARNING! To reduce the risk of electrical shock, burns, fire, or other possible injuries to the user, it is important to review this manual and the following precautions *before* operation.

SAFETY PRECAUTIONS AND TIPS

- ◆ It is the owner's responsibility to ensure that all users of this treadmill have read the Owner's Manual and are familiar with warnings and safety precautions.
- ◆ This treadmill has a user maximum capacity of 250 pounds.
- ◆ The treadmill should only be used on a level surface and is intended for indoor use only. The treadmill should not be placed in a garage, patio, or near water and should never be used while you are wet. KEYS recommends a treadmill mat be placed under the treadmill to protect floor or carpet and for easier cleaning.
- ◆ Follow safety information in regards to plugging in your treadmill. Keep the power cord away from the incline wheels and do not run the power cord underneath your treadmill. Do not operate the treadmill with a damaged or frayed power cord.
- ◆ Wear comfortable, good-quality walking or running shoes and appropriate clothing. Do not use the treadmill with bare feet, sandals, socks or stockings.
- ◆ Always straddle the belt and allow it to start moving before stepping onto the belt.
- ◆ Hold on to handrails when adjusting speed, incline, or other controls.
- ◆ Always examine your treadmill before using to ensure all parts are in working order.
- ◆ Allow the belt to fully stop before dismounting.
- ◆ Pets should never be allowed near or on the treadmill.
- ◆ Do not leave children unsupervised near or on the treadmill.
- ◆ Never operate the treadmill where oxygen is being administered, or where aerosol products are being used.
- ◆ Never insert any object or body parts into any opening.
- ◆ For safety and to prevent damage to your treadmill, no more than one person should use the treadmill at a time.
- ◆ Always unplug the treadmill before cleaning and/or servicing. Service to your treadmill should only be performed by an authorized service representative, unless authorized and/or instructed by the manufacturer
- ◆ Failure to follow these instructions will void the treadmill warranty.
- ◆ Never leave the treadmill unattended while it is running



Before You Start

Thank you for purchasing the DISCOVERY 120 treadmill! This quality product you have chosen was designed to meet your needs for cardiovascular exercise.

Before you start, please read the Owner's Manual and become familiar with the operation of your new treadmill.

Remember to take the time to perform the stretching exercises provided to avoid injury.

- ◆ Do not stand on the walking belt while pressing the Power button or Start/Stop button.
- ◆ Always adjust the speed of the treadmill in small increments as this treadmill is capable of high speeds.
- ◆ If you are taking medication, consult your physician to see if the medication will affect your exercise heart rate.
- ◆ If you have heart problems, you are not active, and/or are over the age of 35 years, do not use the pre-set treadmill programs or start an exercise program without first contacting and receiving approval from your physician.
- ◆ To avoid the risk of electrical shock, always keep the console dry. Do not spill liquids on the console. KEYS recommends a sealed water bottle for beverages consumed while using the treadmill.
- ◆ **Please review the following drawing below to familiarize yourself with the listed parts. This manual covers several treadmills, so the one pictured below may not be identical to your particular model**

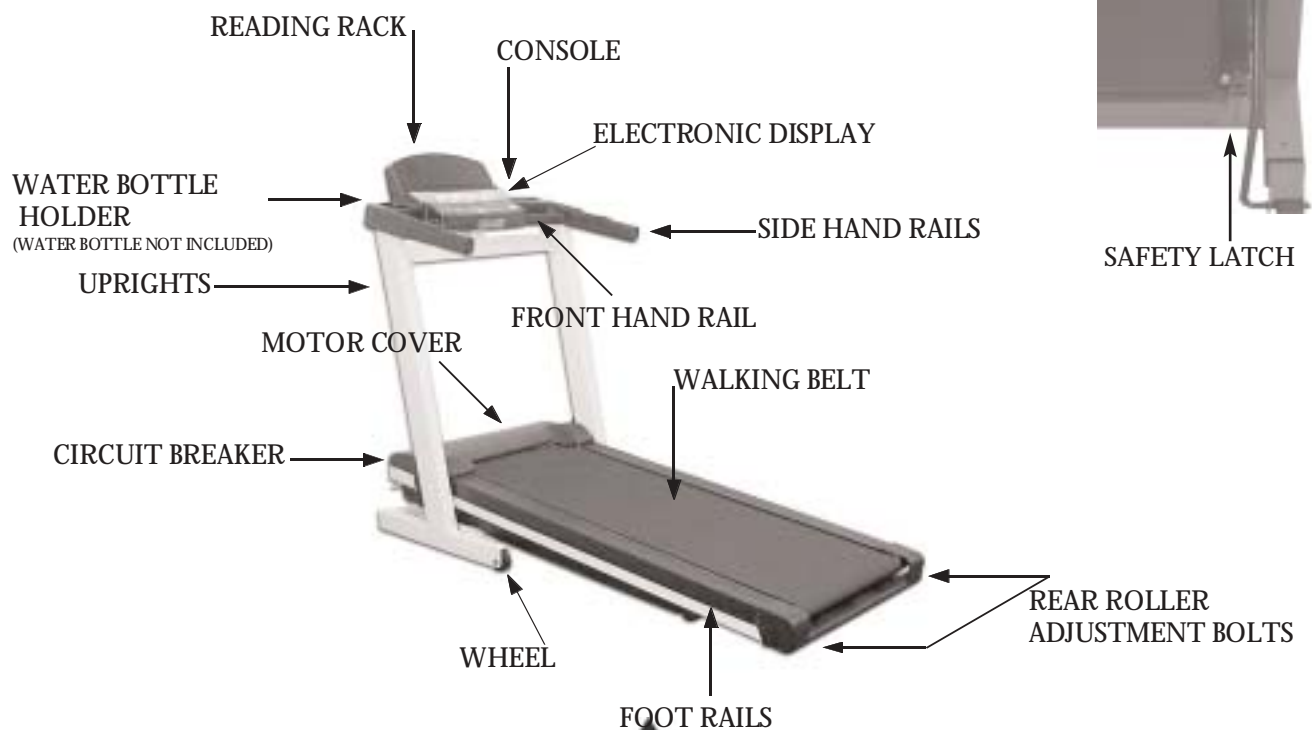

Warm Up Exercises

EXERCISE GUIDELINES

WARNING! Before beginning this or any exercise program, you should consult your physician. This is especially important for individuals over the age of 35 or individuals with pre-existing health problems.

Warming up prepares the body for the exercise by increasing circulation, supplying more oxygen to the muscles and raising body temperature. Begin each workout with 5 to 10 minutes of stretching and light exercise to warm up. The photos on this page show several forms of basic stretching you may perform before your workouts. In order to achieve an adequate warm-up, perform each stretch three times.

TOE TOUCH STRETCH

Stand bending your knees slightly and slowly bend forward from your hips. Allow your back and shoulders to relax as you reach down toward your toes as far as possible. Hold for 15 counts, then relax. This will stretch your hamstrings, back of knees, and back.



HAMSTRING STRETCH

Sit with one leg extended. Bring the sole of the opposite foot toward you and rest it against the inner thigh of your extended leg. Reach toward your toes as far as possible. Hold for 15 counts, then relax. This will stretch your hamstrings, lower back, and groin.



CALF/ACHILLES STRETCH

With one leg in front of the other, reach forward and place your hands against a wall. Keep your back leg straight and your back foot flat on the floor. Bend your front leg, lean forward and move your hips toward the wall. Hold for 15 counts, then relax. To cause further stretching of the Achilles tendon, bend your back leg as well. This will stretch your calves, Achilles tendons, and ankles.



QUADRICEPS STRETCH

With one hand against a wall for balance, reach back and grasp one foot with your other hand. Bring your heel as close to your buttocks as possible. Hold for 15 counts, then relax. This will stretch your quadriceps and hip muscles.



INNER THIGH STRETCH

Sit with the soles of your feet together and your knees outward. Pull your feet toward your groin area as far as possible. Hold for 15 counts, then relax. This will stretch your quadriceps and hip muscles.

Assembly, Moving Instructions

Assembly

The DISCOVERY 120 treadmill is shipped in one piece and fully assembled. After opening the box, remove any packing materials from the treadmill. Do not throw away any packing materials until the unit is working properly. Place the base on a clean, level surface. Make sure the electrical cord will easily reach an electrical outlet.

Moving

CAUTION! TO AVOID THE RISK OF INJURY, NEVER ATTEMPT TO MOVE THE TREADMILL WHILE IT IS IN THE UNFOLDED OPERATING POSITION. TO REDUCE THE POSSIBILITY OF INJURY WHILE LIFTING, BEND YOUR LEGS AND KEEP YOUR BACK STRAIGHT. AS YOU RAISE THE TREADMILL, LIFT USING YOUR LEGS, NOT YOUR BACK. IN ORDER TO RAISE OR LOWER THE TREADMILL SAFELY, YOU MUST BE ABLE TO LIFT 45 POUNDS (20KG). IT IS SUGGESTED YOU ALWAYS USE THE AID OF A SECOND PERSON WHEN MOVING THE TREADMILL.

With the treadmill in the folded locked position (safety latch is engaged), grasp the handrails and place one foot on the base as shown in the photo below. Next, with a firm grasp on handrails, place one foot on the center of the base crossbar and carefully tilt the treadmill back until it rolls freely on the wheels. Using extreme caution, move the treadmill to the desired location. To set the treadmill down, place one foot on the center of the base crossbar and carefully lower treadmill onto base in resting position. Do not attempt to move the treadmill over an uneven or rough surface.

Figure 1



Power Requirements

IMPROPER CONNECTION OF THE EQUIPMENT GROUNDING CONNECTOR CAN RESULT IN A RISK OF AN ELECTRIC SHOCK. CHECK WITH A QUALIFIED ELECTRICIAN OR SERVICE MAN IF YOU ARE IN DOUBT AS TO WHETHER THE PRODUCT IS PROPERLY GROUNDING. DO NOT MODIFY THE PLUG PROVIDED WITH THE PRODUCT IF IT WILL NOT FIT THE OUTLET. HAVE A PROPER OUTLET INSTALLED BY A QUALIFIED ELECTRICIAN.

This treadmill can be seriously damaged by sudden voltage changes in your home's electrical power. Voltage spikes, surges, and noise interference can result from weather conditions or from other appliances being turned on or off. To reduce the possibility of treadmill damage, always use a surge protector (not included) with your treadmill.

Surge protectors can be purchased at most hardware stores. The manufacturer recommends a single outlet surge protector with UL 1449 rating as a Transient Voltage Surge Suppressor (TVSS) with UL suppressed voltage rating of 400V or less and an electrical rating of 120VAC, 15 amps.

This treadmill must be grounded to reduce the risk of electrical shock. Grounding provides a path of least resistance for electric current should the treadmill malfunction. This treadmill comes with an electrical cord with an equipment-grounding conductor and a grounding plug. Always plug the power cord into a surge protector, and plug the surge protector into an appropriate outlet that is properly installed and grounded in accordance with all local codes and ordinances.

This product is for use on a nominal 120-volt circuit and has a grounding plug that looks like the plug illustrated in the drawing below.

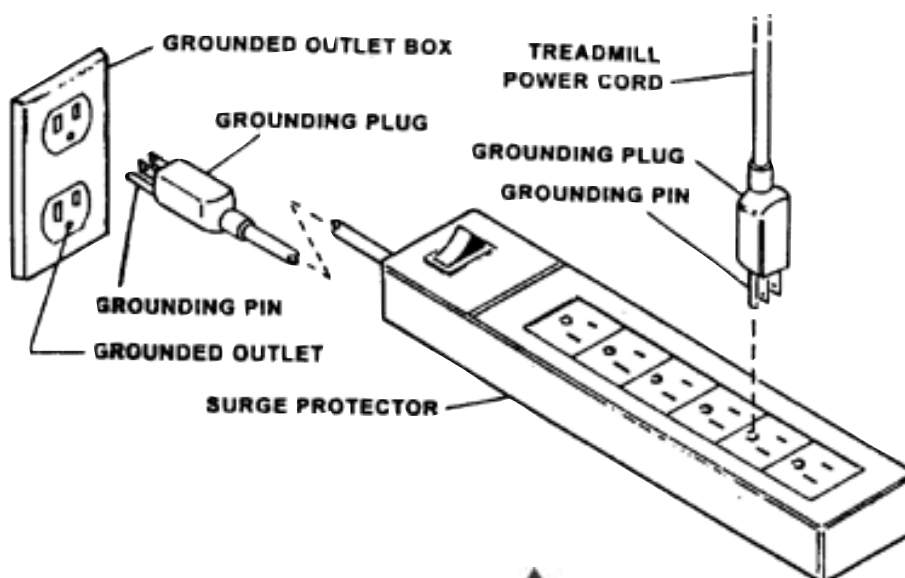

Console Functions and Descriptions

There are four display windows on the control panel to provide feedback information.

TIME WINDOW

- ◆ **TIME:** Indicates elapsed time after pressing start in minutes and seconds (0-99 minutes, 0-59 seconds)
- ◆ **INTERVAL TIME:** Indicates countdown in seconds to the next interval starting at 5 seconds and counting to 0 seconds

SPEED WINDOW

- ◆ **SPEED:** Indicates MPH (miles per hour) or KMH (kilometer per hour) in .1 increments

DISTANCE / CALORIES WINDOW

- ◆ **DISTANCE:** Indicates Miles or Kilometers traveled in .01 increments up to 9.99 and .1 increments starting at 10.0
- ◆ **CALORIES:** Indicates estimated calories used based on 150 lb. person at the indicated speed, incline, and time

INCLINE WINDOW

- ◆ **INCLINE:** Indicates incline in percent of grade 0-12% in 0.5 increments

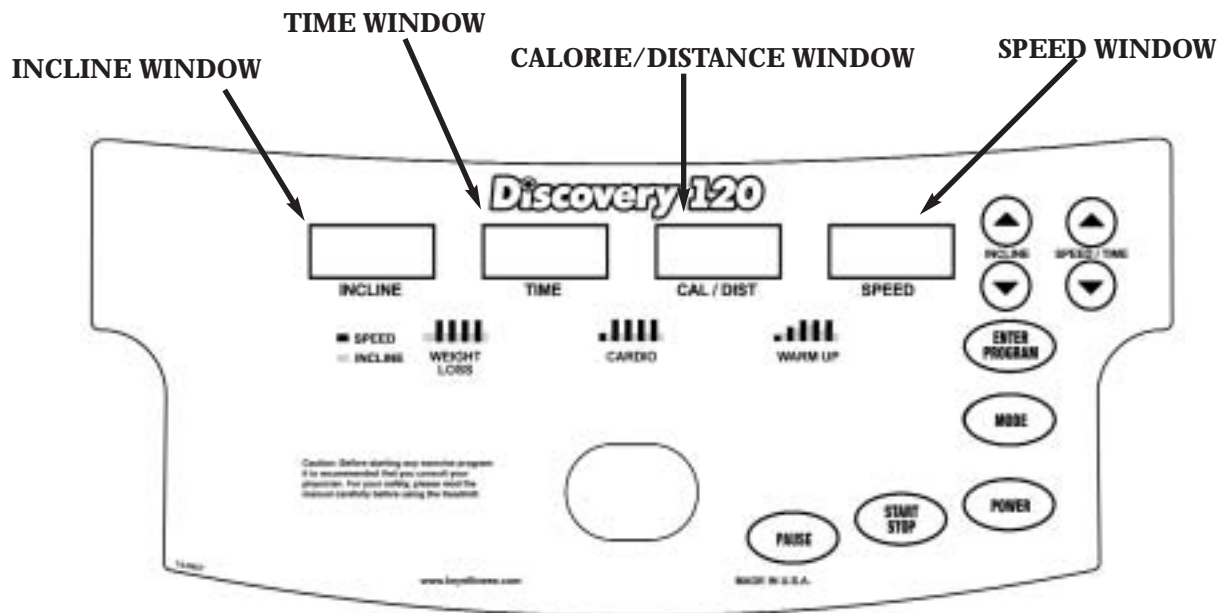

Program and Operating Instructions

QUICK START / MANUAL MODE

- ◆ Plug into a surge protector outlet. Attach the **Red Safety Key** on to the treadmill console.
- ◆ Stand on the treadmill and straddle belt. Attach safety key clip to your clothes.
- ◆ Press **POWER** button. There will be an eight (8) second delay after pressing the **POWER** button before data can be entered. The **TIME** window will flash.
- ◆ Press **START/STOP** button. Belt will begin to move after 4 seconds. Step on belt slowly after the belt starts moving. Speed or incline may be adjusted by using the appropriate **+** (increase) or **-** (decrease) button.
- ◆ To end your workout, press **START/STOP** button. Belt will gradually slow to zero.
- ◆ To pause your workout, press **PAUSE**.
- ◆ To re-start after pausing: Press the **PAUSE** button. **WARNING: THE TREADMILL BELT WILL RESUME AT THE SPEED THE TREADMILL WAS MOVING BEFORE PAUSING.**
- ◆ Countdown Time, Preset Speed and/or Incline: Time, Speed, and Incline may be preset prior to getting started. After pressing the **POWER** button, the time window will blink. Use the **SPEED +** or **-** arrows to select your workout time, then press the **ENTER PROGRAM** button. The **SPEED** window will now be flashing. Using the same **+** or **-** arrows, select the speed for your workout, then press **ENTER PROGRAM**. Now the **INCLINE** window will be flashing. Use the **INCLINE +** or **-** arrows to set your workout incline, then press **ENTER PROGRAM**. To start, press the **START/STOP** button.

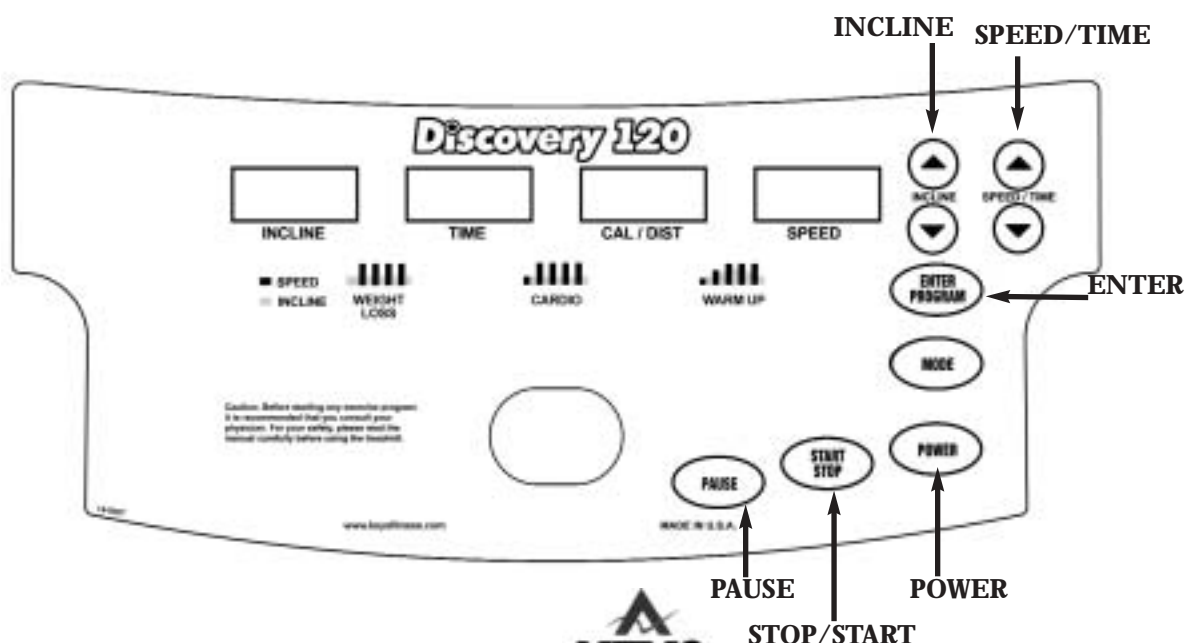

Program and Operating Instructions

PROGRAM MODE

Plug treadmill into a surge protector outlet. Attach the Red Safety Key on to the treadmill console.

- ◆ Stand on the treadmill and straddle belt. Attach safety key clip to your clothes.
- ◆ Press POWER button. There will be an eight (8) second delay before data can be entered. The TIME window will flash.
- ◆ There are three (3) pre-set and eight (6) custom pre-set programs on the DCV120. The treadmill includes WEIGHT LOSS, CARDIO, and WARM-UP programs. To Select the program press the MODE button until desired program is illuminated on console display.
- ◆ Press START/STOP button. Belt will begin to move after 4 seconds. Step on belt slowly after the belt starts moving.
- ◆ **CUSTOMIZING PROGRAMS in P1 and P2 Mode:** Each pre-set program (Weight Loss, Cardio, and Warm-up) can be customized in the P1 or P2 mode. After making the program selection, the CAL/DIST window will read "OP". The "OP" refers to "original program" and is preset. The program name you select will illuminate on the console display. Press the MODE button once more and the CAL/DIST window will read P1. The "P1" mode is now accessed. You can now program the Time, Speed, and Incline in P1 mode, which will be saved for future workouts.
 - 1) The TIME window will blink. Use the SPEED + or - arrows to select your workout time. Press ENTER PROGRAM.
 - 2) The SPEED window will then blink. Use the same + or - arrows to select the speed for your workout. Press ENTER PROGRAM.
 - 3) The INCLINE window will then blink. Use the INCLINE + or - arrows to set your workout incline. Press ENTER PROGRAM.

To start, press the START/STOP button. To access P2 mode, press the MODE button for desired program, then press the MODE button again (once for OP, twice for P1, three times for P2). Follow the above steps 1-3 to customize P2 settings.
- ◆ **TO CHANGE A PREVIOUSLY PROGRAMMED P1, P2, or user program:** Once you have programmed the P1 or P2 modes, you will need to use the PAUSE button to change the program you previously entered. For instance to change to a new setting in P1-WEIGHT LOSS, press the WEIGHT LOSS button twice to access P1. Then press the PAUSE button to get the WORKOUT TIME window to flash. Follow the directions above to continue to change the program.

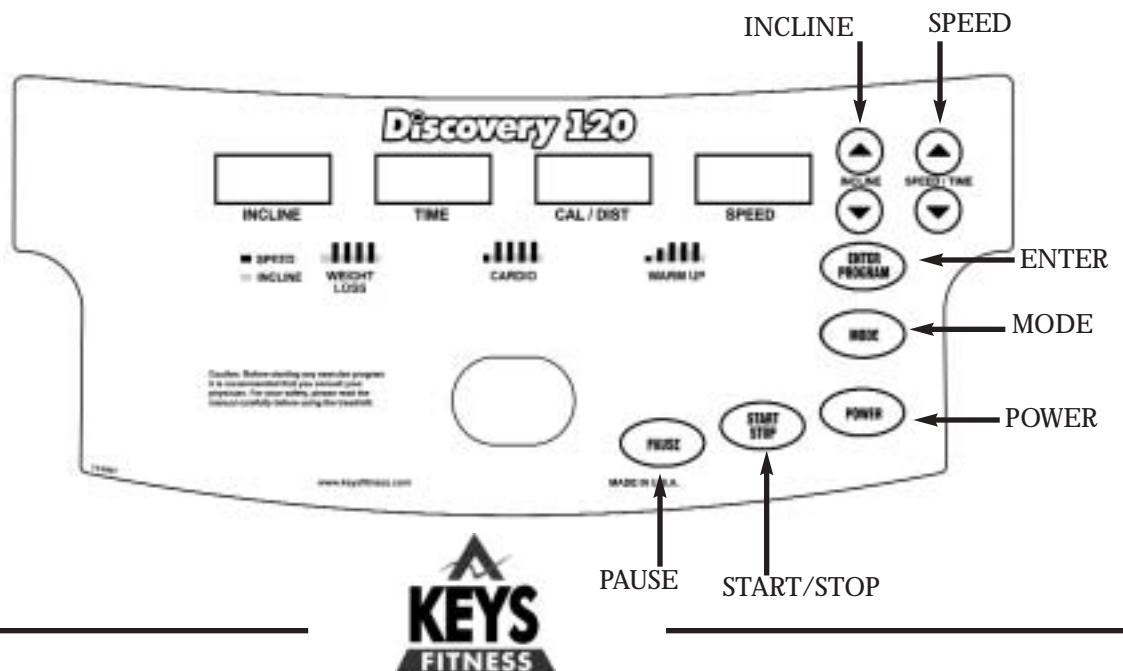

Program Profiles

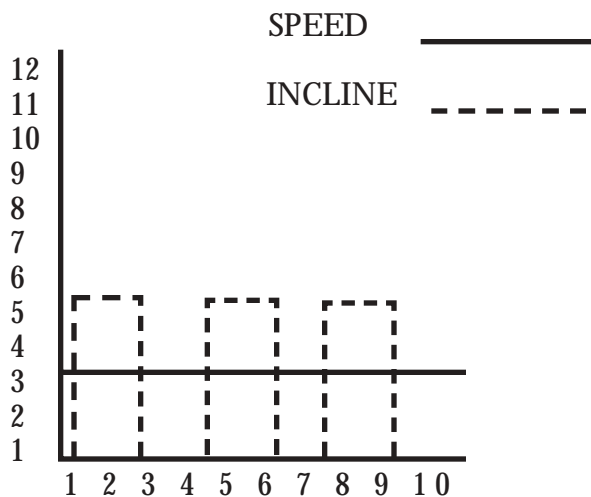

The **Weight Loss Program** is designed to vary the treadmill elevation, while maintaining a constant walking belt speed.

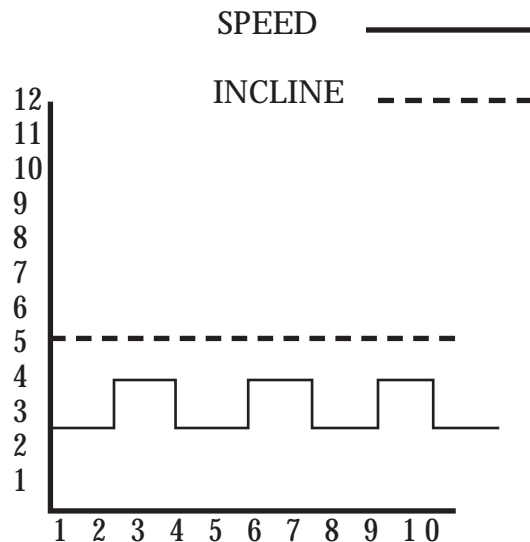

The **Cardio Program** is designed to vary the treadmill Speed, while maintaining a constant Elevation.

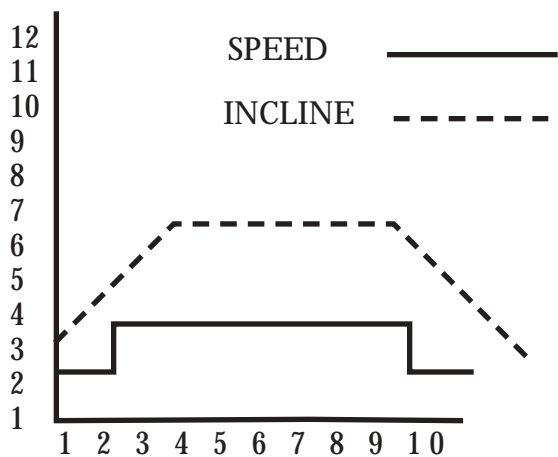

The **Warm Up Program** is designed to gradually increase the treadmill Speed and Elevation in the first segment (warm up) and gradually decrease the treadmill Speed and Elevation in the last segment (cool down). This is also known as a Plateau program.

Belt Adjustment and Tension

WARNING! Do not over-tighten rollers! This will cause premature roller bearing failure!

Belt adjustment and tension performs two functions: adjustment for tension and centering. Your new treadmill comes pre-adjusted from the factory for tension and centering. Please follow the procedures below if the belt shifts to the left or right while walking:

WALKING BELT IS SHIFTING TO THE LEFT (Diagram 1)
First, turn treadmill on to run at 1 mph. Using the hex key provided turn the left rear roller adjustment bolt $\frac{1}{4}$ turn in the clockwise direction. Next, run the treadmill at 2.5 mph. You should see the belt start to correct itself by moving back towards the center. Repeat the above procedure until the walking belt is centered. It may be necessary to set walking belt tension once you have completed this procedure if the belt feels like it is slipping while walking. Refer below to the "Walking Belt Slipping" instructions.



WALKING BELT IS SHIFTING TO THE RIGHT (Diagram 2)
First, turn the treadmill on to run at 1 mph. Using the hex key provided, turn the right rear roller adjustment bolt $\frac{1}{4}$ turn in the clockwise direction. Next, run the treadmill at 2.5 mph. You should see the belt start to correct itself, moving back towards the center. Repeat the above procedure until the walking belt is centered. It may be necessary to set walking belt tension once you have completed this procedure if the belt feels like it is slipping while walking. Refer below to the "Walking Belt Slipping" instructions.



WALKING BELT IS SLIPPING DURING USE (Diagram 3)

First, unplug the power cord from the surge protector. Using the hex key provided, turn both left and right rear roller adjustment bolts the same distance, usually a $\frac{1}{4}$ turn in the clockwise direction. Plug the power cord back into the surge protector and run the treadmill at 2.5 mph. You should now walk on the belt to determine if the belt is still slipping. Repeat the above procedure until the walking belt is not slipping. The tension should be just tight enough not to slip.



- ◆ Turning the hex key counter clockwise brings the rear rollers belt towards you.
- ◆ Turning the hex key clockwise pushes the rear roller and belt away from you.

Change Miles per hour to Kilometers per hour

Your treadmill will operate in British Units (miles per hour) or International Units (kilometers per hour). All treadmills are calibrated at the factory for British Units (miles per hour). To change the display to read in kilometers, follow the steps described here:

- 1) Turn power OFF on the console. (Do not unplug treadmill) Attach the magnet safety key to the console.
- 2) Activate the calibration mode switch by inserting the eraser end of a pencil into the opening in the backside of the console (see diagram below).
- 3) Depressing the calibration mode switch ONCE; CL11 should appear in the TIME window.
- 4) Pressing the SPEED +/- button will activate your choice.
- 5) To accept the setting, press the POWER button.

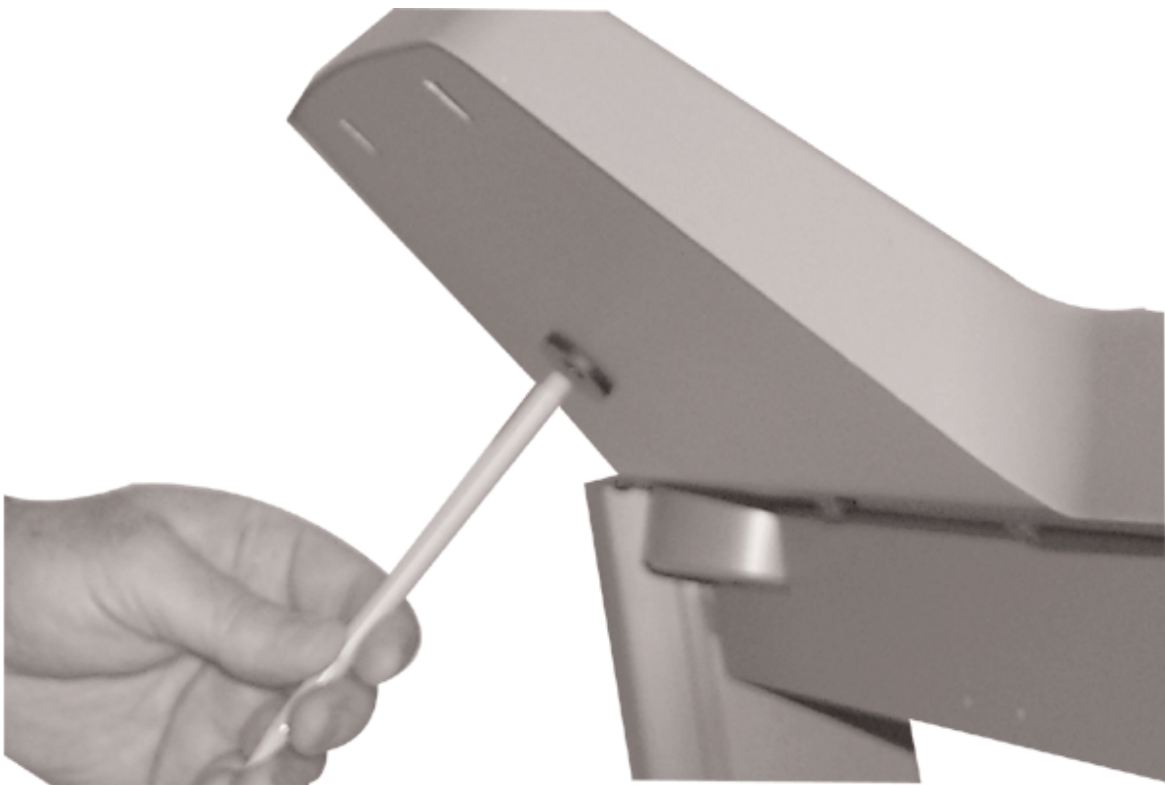

Maintenance Instructions

WARNING! Before performing any maintenance to your treadmill, always unplug the power cord from the surge protector.

CLEANING

Routine cleaning of your Keys Fitness treadmill will extend the life of your treadmill. **WARNING!** To prevent electrical shock, be sure the power to the treadmill is OFF and the unit unplugged from the wall electrical outlet before attempting any cleaning or maintenance.

AFTER EACH WORKOUT: Wipe off the console and other treadmill surfaces with a clean, water dampened soft cloth to remove excess perspiration. **USE NO CHEMICALS.**

WEEKLY: Use of a treadmill mat is recommended for ease of cleaning. Dirt from your shoes contacts the belt and eventually makes it to underneath the treadmill. Vacuum underneath treadmill once a week.

DECK LUBRICATION

The walking belt has been pre-lubricated at the factory. However, it is recommended that the walking board be checked periodically for lubrication to ensure optimal treadmill performance.

Every 30 days or 30 hours of operation, lift the sides of the walking belt and feel the top surface of the walking board as far under as you can reach. If you feel signs of silicone, no further lubrication is required. If it feels dry to the touch, follow the instructions below.

KEYS recommends “Lube N Walk” for cleaning and lubricating the treadmill belt and deck. Ask your retailer or call KEYS at 800-340-0482. You may also use silicone such as “Napa 8300” (available at most stores).

TO APPLY LUBRICANT TO THE WALKING BOARD

- 1) Position the walking belt so that the seam is located on top and in the center of the center of the walking board.
- 2) Insert the spray nozzle into the spray head of the lubricant can.
- 3) While lifting the side of the walking belt, position the spray nozzle between the walking belt and the board approximately 6” from the front of the treadmill. Apply the silicone spray to the walking board, moving from the front of the treadmill to the rear. Repeat this on the other side of the belt. Spray approximately 4 seconds on each side.
- 4) Allow the silicone to ‘set’ for one minute before using the treadmill.

WARNING: Do not over-lubricate the walking board. Excess lubricant should be wiped off with a clean towel.

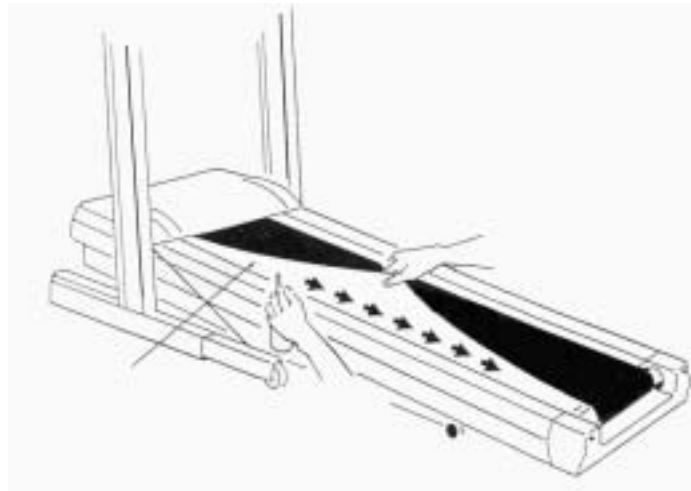

Treadmill will not start.

- 1 Is the **Safety Key** inserted into the treadmill Console?
- 2 Make sure the power cord is plugged into a surge protector, the surge protector is plugged into a properly grounded outlet, and the surge protector is turned on. (Refer to “Power Requirements” on page 8)
- 3 Check the circuit breaker located on the front of the treadmill. If the switch protrudes, it has tripped. Wait five minutes and then press the switch back in.
- 4 Check the house electrical breaker box and the circuit breaker for the room where the treadmill is located. If it has tripped, reset or have an electrician replace the breaker in home.
- 5 Have an electrician check for inadequate voltage at the outlet.

Treadmill loses power during use.

- 1 Check the circuit breaker located on the front of the treadmill. If the switch protrudes, it has tripped. Wait five minutes and then press the switch back in.
- 2 Check the house electrical breaker box and the circuit breaker for the room where the treadmill is located. If it has tripped, reset or have an electrician replace the breaker in home.
- 3 If the treadmill still will not operate, please call Keys Technical Service at (888) 340-0482.

Treadmill walking belt slows during use.

- 1 Check to make sure the treadmill is securely plugged into an UL-listed surge protector, rated at 15 amps, with a 14-gauge cord of five feet or less and the surge protector is securely plugged into the outlet.
- 2 If treadmill still will not operate, please call Keys Technical Service at (888) 340-0482.

Treadmill walking belt slips or is not centered on rear roller.

- 1 Refer to “Belt Adjustment and Tension” section on page 13.
- 2 Need help? Call Keys Technical Service at (888) 340-0482.

Treadmill Error Messages.

Your treadmill is equipped with a software package that enables error messages to be displayed when there is a problem. **To avoid possible damage to the treadmill and the possibility of injury, do not operate the treadmill until the problem is corrected. Call Keys Technical Service at (888) 340-0482. Or see page 17 of this Owners Manual.**



Error Messages

Treadmill Error Messages.

Your treadmill is equipped with a software package that enables error messages to be displayed when there is a problem. The following error codes will be displayed in the console display windows.

Safety Interlock Error Messages

SI 1 - Safety key missing, replace and try again.

SI 2 - Over voltage protection trip. Notify Keys Fitness Technical Service.

SI 3 - Tilt Switch Trip. Notify Keys Fitness Technical Service.

Other Error Messages

E11 - Lack of speed feedback data from belt motor. Attempt re-calibration. See Calibration Sequence section for detailed information.

E22 - Under Speed condition detected from the belt motor. Attempt re-calibration. See Calibration Sequence section for detailed information.

E33 - Over Speed condition detected from the belt motor. Attempt re-calibration. See Calibration Sequence section for detailed information.

To avoid possible damage to the treadmill and the possibility of injury, do not operate the treadmill until the problem is corrected. Call Keys Technical Service at (888) 340-0482.

Calibration Sequence

Our treadmill is equipped with a software package that will perform a calibration sequence unique to your specific model number. Please perform the following steps to calibrate the **KEYS DISCOVERY 120 TREADMILL**.

1. Unplug power cord from outlet strip.
2. Attach Safety Key to console.
3. Plug power cord into outlet strip.
4. Initiate calibration sequence. Locate hole on the back of the console and insert the eraser end of a pencil through the hole and press the calibration switch **twice**. As show on page 14.
5. **CL21** should appear in the Time window, if not, continue to press the calibration switch until CL21 appears.

Note: During the calibration sequence, the Time window will display which step you are at in the process (C21, C22, C23 and so on). The CAL/DIST window will display which key should be entered next. For example, “E” for Enter, “P” for Power, or “SS” for Start / Stop.

6. **CL21:** MPH or KPH will be flashing in the Speed window, pressing the Speed +/- button will toggle options. Choose **MPH** (KPH), press Enter.
 7. **CL22:** 8, 10, or 12 (13, 16, or 20 in KPH mode) will be displayed in the Speed window, pressing the Speed +/- button will toggle options. Choose **10** (or 16 for KPH mode), press Enter.
 8. **CL23:** FFF, UUU, or HHH will be displayed in the Speed window, pressing the Speed +/- button will toggle options. Choose **FFF**, press Enter.
 9. **CL24:** 111 or 222 will be displayed in the Speed window, pressing the Speed +/- button will toggle options. Choose **111**, press Enter.
 10. **CL25:** AL1 or AL2 will be displayed in the Speed window, pressing the Speed +/- button will toggle options. Choose **AL2**, press Enter.
 11. **CL26:** OPA or OPI will be displayed in the Speed window, pressing the Speed +/- button will toggle options. Choose **OPA**, press Enter.
 12. **CL27:** Blank (nothing), “a”, “b”, “c”, or “d” will be displayed in the Incline window, pressing the Speed +/- button will toggle options. Choose **Blank**, press Enter.
 13. CAL/DIST window will display “E”, Press Enter. “55” will display in CAL/DIST window.
 14. Press Start/ Stop.
 15. At this time, make sure you are not standing on the walking belt, as the machine will automatically initiate belt movement and run through a complete calibration and diagnostic routine. Press **Enter**, belt will begin to move, unit will begin self-calibration.
 16. When Speed and Incline calibration has finished, press Power button **twice**, display should blank, and treadmill should be ready for use.
- To avoid possible damage to the treadmill and the possibility of injury, do not operate the treadmill until the problem is corrected. Call Keys Technical Service at (888) 340-0482.**



Parts & Diagrams

		Pat#
1	Left Side Extrusion Rail	05-0036
2	Right Side Extrusion Rail	05-0036
3	Treadmill Belt	04-0025
4	Front Roller Assembly	24-0218
5	Rear Roller	09-0013
6	Treadmill Deck	03-0011
7	End Cap (L/R)	06-0008
8	Elevation Motor (actuator)	12-0022
9	3 Piece Bottom Pan- <i>Motor</i>	06-0018
	<i>Middle</i>	06-0019
	<i>End</i>	06-0020
10	Small Fan	06-0080
11	Motor	12-0023
12	Poly V Belt	04-0004
13	Motor Hood Cover Top	06-0105
14	Hand Grips	21-0101
15&16	Console Assembly	24-0246
17	Motor Controller	08-0051

Please review the following drawing below to familiarize yourself with the listed parts. This manual covers several treadmills, so the one pictured below may not be identical to your particular model.

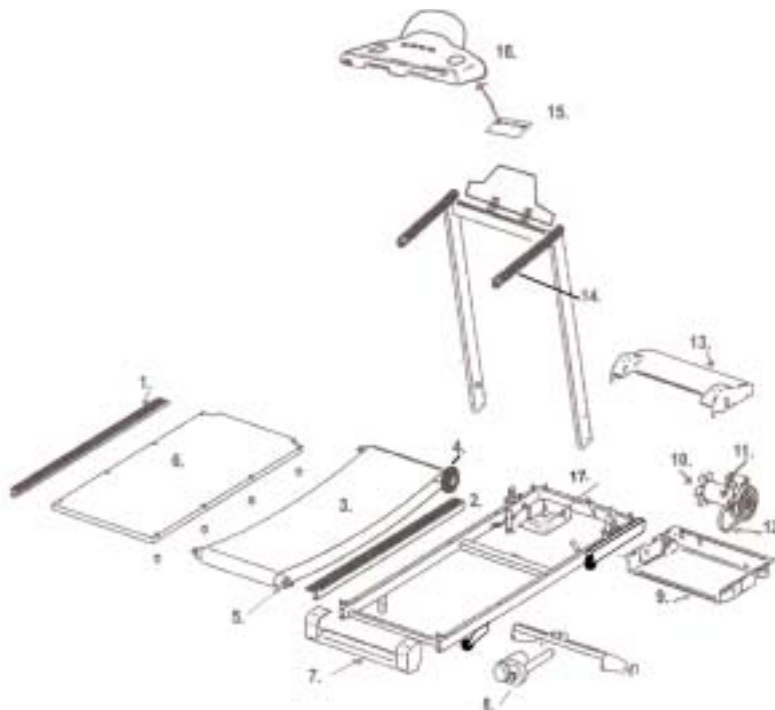

Keys DISCOVERY 120 Treadmill KEYS FITNESS PRODUCTS, LP – LIMITED WARRANTY

PLEASE CONSULT YOUR PHYSICIAN BEFORE USING THIS PRODUCT.

This Limited Warranty applies in the United States and Canada to products manufactured or distributed by Keys Fitness Products, LP ("Keys") under the KEYS brand name. The warranty period on the DCV120 to the original purchaser is (lifetime) on the frame, (10) years on the motor, (1) year parts, and (90) days labor.

Keys warrants that the Product you have purchased for non-commercial, personal, family, or household use from Keys or from an authorized Keys reseller is free from defects in materials or workmanship under normal use during the warranty period. Your sales receipt, showing the date of purchase of the Product, is your proof of the date of purchase. This warranty only extends to you, the original purchaser. It is not transferable to anyone who subsequently purchases the Product from you. It excludes expendable parts. This Limited Warranty becomes VALID ONLY if the treadmill is assembled/installed by a Keys Fitness authorized dealer/technician unless otherwise authorized by Keys Fitness in writing (if anyone other than a Keys Fitness authorized dealer/technician assembles a Keys Fitness treadmill the warranty will be void unless accompanied by written authorization by Keys Fitness).

During the warranty period Keys will at no additional charge, repair or replace (at Keys' option) the product if it becomes defective, malfunctions, or otherwise fails to conform with this Limited Warranty under normal non-commercial, personal, family or household use. In repairing the Product, Keys may replace defective parts, or at the option of Keys, serviceable used parts that are equivalent to new parts in performance. All exchanged parts and Products replaced under this warranty will become the property of Keys. Keys reserves the right to change manufacturers of any part to cover any existing warranty.

To obtain warranty service, you must contact a Keys authorized service technician or Keys Fitness at our phone numbers located in this manual. Any parts determined to be defective must be returned to Keys to obtain warranty service. You must prepay any shipping charges, export taxes, custom duties and taxes, or any other charges associated with transportation of the parts or Product. In addition, you are responsible for insuring any parts or Product shipped or returned. You assume the risk of loss during shipment. You must present Keys with proof-of-purchase documents (including the date of purchase). Any evidence of alteration, erasing or forgery of proof-of-purchase documents will be cause to void this Limited Warranty.

This warranty does not extend to any product not purchased from Keys or from an authorized Keys reseller. This Limited Warranty does not extend to any Product that has been damaged or rendered defective; (a) as a result of accident, misuse, or abuse; (b) by the use of parts not manufactured or sold by Keys; (c) by modification of the Product or normal wear and tear; (d) operation on incorrect power supplies; or (e) as a result of service by anyone other than Keys, or an authorized Keys warranty service provider. Product on which the serial number has been defaced or removed is not eligible for warranty service. Should any Product be submitted for warranty service be found ineligible therefore, an estimate of repair cost will be furnished and the repair will be made if requested by you upon Keys' receipt of payment or acceptable arrangements for payment.

EXCEPT AS EXPRESSLY SET FORTH IN THIS WARRANTY, KEYS MAKES NO OTHER WARRANTIES, EXPRESSED OR IMPLIED, INCLUDING ANY IMPLIED WARRANTIES OF MERCHANTABILITY AND FITNESS FOR A PARTICULAR PURPOSE. KEYS EXPRESSLY DISCLAIMS ALL WARRANTIES NOT STATED IN THIS LIMITED WARRANTY. ANY IMPLIED WARRANTIES THAT MAY BE IMPOSED BY LAW ARE LIMITED TO THE TERMS OF THIS LIMITED WARRANTY. NEITHER KEYS NOR ANY OF ITS AFFILIATES SHALL BE RESPONSIBLE FOR INCIDENTAL OR CONSEQUENTIAL DAMAGES. SOME STATES DO NOT ALLOW LIMITATIONS ON HOW LONG AN IMPLIED WARRANTY LASTS OR THE EXCLUSION OR LIMITATION OF INCIDENTAL OR CONSEQUENTIAL DAMAGES, SO THE ABOVE LIMITATIONS OR EXCLUSION MAY NOT APPLY TO YOU. This Limited Warranty gives you specific legal rights and you may also have other rights that may vary from state to state. This is the only express warranty applicable to Keys-branded products. Keys neither assumes nor authorizes anyone to assume for it any other express warranty.

PLEASE SEND IN THE ATTACHED WARRANTY CARD WITHIN TEN (10) DAYS OF PURCHASE TO REGISTER YOUR TREADMILL WITH KEYS FITNESS PRODUCTS, LP. MADE IN THE USA. Thank you for your business! PLEASE MAIL WARRANTY CARD TO: KEYS FITNESS PRODUCTS, PO BOX 551239, DALLAS, TX 75355. Or online at www.keysfitness.com

KEYS FITNESS TREADMILL WARRANTY REGISTRATION				TELEPHONE	
FIRST	MI	LAST	<input type="text"/> <input type="text"/> <input type="text"/> - <input type="text"/> <input type="text"/> <input type="text"/> <input type="text"/> <input type="text"/> <input type="text"/> <input type="text"/> <input type="text"/>		
ADDRESS				APT. NO.	
<input type="text"/> <input type="text"/> <input type="text"/> <input type="text"/> <input type="text"/> <input type="text"/> <input type="text"/> <input type="text"/> <input type="text"/> <input type="text"/> <input type="text"/> <input type="text"/> <input type="text"/> <input type="text"/> <input type="text"/> <input type="text"/> <input type="text"/> <input type="text"/> <input type="text"/> <input type="text"/> <input type="text"/>				<input type="text"/> <input type="text"/> <input type="text"/> <input type="text"/>	
CITY			STATE		ZIP
<input type="text"/> <input type="text"/> <input type="text"/> <input type="text"/> <input type="text"/> <input type="text"/> <input type="text"/> <input type="text"/> <input type="text"/> <input type="text"/> <input type="text"/> <input type="text"/> <input type="text"/> <input type="text"/> <input type="text"/> <input type="text"/> <input type="text"/> <input type="text"/> <input type="text"/> <input type="text"/> <input type="text"/>			<input type="text"/> <input type="text"/> <input type="text"/> <input type="text"/>		<input type="text"/> <input type="text"/> <input type="text"/> <input type="text"/> <input type="text"/> <input type="text"/>
DATE OF PURCHASE		MODEL NO.		SERIAL NO.	
<input type="text"/> <input type="text"/> - <input type="text"/> <input type="text"/> - <input type="text"/> <input type="text"/>		<input type="text"/> <input type="text"/> <input type="text"/> <input type="text"/> <input type="text"/> <input type="text"/> <input type="text"/> <input type="text"/> <input type="text"/> <input type="text"/> <input type="text"/> <input type="text"/>		<input type="text"/> <input type="text"/> <input type="text"/> <input type="text"/> <input type="text"/> <input type="text"/> <input type="text"/> <input type="text"/>	
Name of store or company where purchased:		Where did you learn about treadmills? TV ___ Radio ___ Friend ___ In Store Display ___ Salesperson ___ Print ad/flyer ___ Internet ___		How important are each feature: Unique Features Least Most Horsepower <input type="checkbox"/> <input type="checkbox"/> <input type="checkbox"/> <input type="checkbox"/> <input type="checkbox"/> Warranty <input type="checkbox"/> <input type="checkbox"/> <input type="checkbox"/> <input type="checkbox"/> <input type="checkbox"/> Price <input type="checkbox"/> <input type="checkbox"/> <input type="checkbox"/> <input type="checkbox"/> <input type="checkbox"/> Look/Design <input type="checkbox"/> <input type="checkbox"/> <input type="checkbox"/> <input type="checkbox"/> <input type="checkbox"/> Folding Feature <input type="checkbox"/> <input type="checkbox"/> <input type="checkbox"/> <input type="checkbox"/> <input type="checkbox"/>	
How do you plan to use the treadmill? Walk ___ Run ___ Both ___		Why did you purchase a treadmill? Dr.'s Orders ___ Loose Weight ___ In-home convenience ___ Improve Cardiovascular Fitness ___ Safety from outdoors ___ Other _____		Other Comments: _____ _____ _____	
Who will use the treadmill? Male ___ Female ___ Both ___		KEYS FITNESS respects the rights of your privacy. Our company will not sell or distribute to others the information above. This information is used to track our product quality and to contact you in the event of a product safety concern. It may be used to offer you future Keys products only through the mail. Please check here if wish not to receive any additional information on Keys products. <input type="checkbox"/>			
How many family members? _____					
AGE: 15-24 ___ 25-34 ___ 35-44 ___ 45-54 ___ 55-64 ___ 65+ ___					