

TREADMILL

HORIZON T20

HORIZON T30

HORIZON T40

Owner's Guide



TABLE OF CONTENTS

SAFETY INSTRUCTIONS	3
FOLDING & MOVING	7
LEVELING, POWER & EMERGENCY STOP.....	8
KNOW YOUR TREADMILL (<i>Horizon T20</i>).....	9
GETTING STARTED (<i>Horizon T20</i>).....	10
PROGRAMMING/DISPLAY (<i>Horizon T20</i>).....	11
KNOW YOUR TREADMILL (<i>Horizon T30, T40</i>).....	13
GETTING STARTED (<i>Horizon T30, T40</i>)	14
DISPLAY (<i>Horizon T30, T40</i>).....	18
PROGRAM PROFILES	19
USING YOUR RACE PROGRAM	24
USING YOUR PULSE Zone™ PROGRAM	25
USING YOUR ADVENTURE PROGRAM	27
TROUBLESHOOTING	28
COMMON QUESTIONS	30
MAINTENANCE PROCEDURES	32
EXERCISE GUIDELINES.....	33
DEVELOPING A FITNESS PROGRAM & IMPORTANCE OF WARM UP/ COOL DOWN	34
FITNESS GOALS	35
WEEKLY LOG SHEETS.....	36
MONTHLY LOG SHEETS.....	37
LIMITED HOME USE WARRANTY (<i>Horizon T20</i>)	38
LIMITED HOME USE WARRANTY (<i>Horizon T30, T40</i>)	39



CAUTION

Read all precautions and instructions in this manual before using this equipment.
Save this manual for future reference.

IMPORTANT SAFETY INSTRUCTIONS

SAVE THESE INSTRUCTIONS

Read all instructions before using this Treadmill. When using an electrical product, basic precautions should always be followed, including the following: Read all instructions before using this treadmill

WARNING! Connect this exercise product to a properly grounded outlet only. See grounding instructions.

GROUNDING INSTRUCTIONS

This product must be grounded. If a treadmill should malfunction or breakdown, grounding provides a path of least resistance for electrical current to reduce the risk of electrical shock. This product is equipped with a cord having an equipment-grounding conductor and a grounding plug. The plug must be plugged into an appropriate outlet that is properly installed and grounded in accordance with local codes and ordinances.

DANGER! Improper connection of the equipment-grounding conductor can result in a risk of electric shock. Check with a qualified electrician or serviceman if you are in doubt as to whether the product is properly grounded. Do not modify the plug provided with the product. If it will not fit the outlet, have a proper outlet installed by a qualified electrician.

This product is for use on a nominal 120-volt circuit, and has a grounding plug that looks like the plug illustrated below. A temporary adapter such as the one illustrated below may be used to connect this plug to a 2-pole receptacle as shown, if a properly grounded outlet is not available. The temporary adapter should be used only until a properly grounded outlet can be installed by a qualified electrician. The green colored rigid ear, lug, or the like extending from the adapter must be connected to a permanent ground such as a properly grounded outlet box cover. Whenever the adapter is used, it must be held in place by a metal screw.

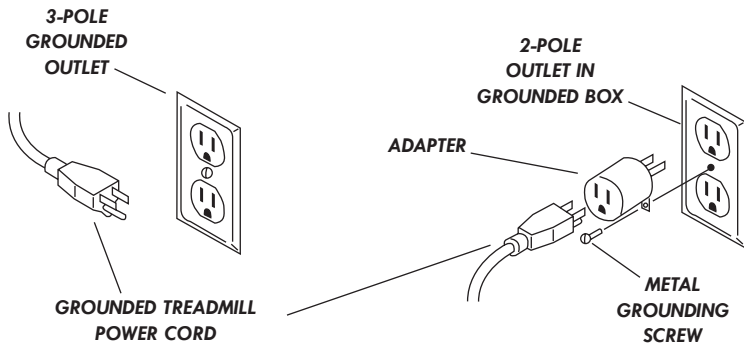



WARNING! To reduce the risk of burns, fire, electrical shock or injury to persons:

- Never use the treadmill before securing the safety tether clip to your clothing.
- If you experience chest pains, nausea, dizziness, or shortness of breath, stop exercising immediately and consult your physician before continuing.
- Do not wear clothes that might catch on any part of the treadmill.
- Keep power cord away from heated surfaces.
- Keep children off of treadmill at all times.
- The treadmill should only be used on a level surface and is intended for indoor use only. The treadmill should not be placed in a garage, patio, or near water and should never be used while you are wet.
- Unplug treadmill before moving it.
- Treadmill should be plugged into a dedicated 20amp circuit.
- At no time should more than one person be on treadmill while in operation.

CHILDREN

- Keep children off your Treadmill at all times.
- When the Treadmill is in use, young children and pets should be kept at least 10 feet away.

CLEANING

- Clean with soap and slightly damp cloth only; never use solvents.

OTHER SAFETY TIPS FOR YOUR HORIZON FITNESS TREADMILL



CAUTION! If you experience chest pains, nausea, dizziness or shortness of breath, stop exercising immediately and consult your physician before continuing.

- Do not wear clothing that might catch on any part of the Treadmill.
- Read this Owner's Guide before operating this Treadmill.

OPERATION

To reduce the risk of damaging important components on your treadmill, it is strongly recommended that your treadmill is plugged into a dedicated **20amp outlet, without the use of an additional extension cord.**

It is essential that your treadmill is used only indoors, in a climate controlled room. If your treadmill has been exposed to colder temperatures or high moisture climates, it is strongly recommended that the treadmill is warmed up to room temperature before first time use. Failure to do so may cause premature electronic failure.

CONGRATULATIONS! on choosing a Horizon Series treadmill.

You've taken an important step in developing and sustaining an exercise program! Your treadmill is a tremendously effective tool for achieving your personal fitness goals. Regular use of your treadmill can improve the quality of your life in so many ways.

Here are just a few of the health benefits of aerobic exercise:

- **Weight Loss**
- **A Healthier Heart**
- **Improved Muscle Tone**
- **Increased Daily Energy Levels**
- **Reduced Stress**
- **Help In Countering Anxiety and Depression**
- **An Improved Self Image**

The key to reaping these benefits is to develop the exercise habit. Your new treadmill will help you eliminate the obstacles that prevent you from getting in your exercise time. Inclement weather and darkness won't interfere with your workout when you use your treadmill in the comfort of your home. This manual provides you with basic information for using and enjoying your new machine. A more complete knowledge of your new treadmill will assist you in realizing your goal of a healthy lifestyle.



CAUTION: BEFORE BEGINNING ANY EXERCISE PROGRAM, ALWAYS CONSULT YOUR PHYSICIAN. IF YOU EXPERIENCE CHEST PAINS, NAUSEA, DIZZINESS OR SHORTNESS OF BREATH, STOP EXERCISING AND CONSULT YOUR PHYSICIAN BEFORE CONTINUING.

IMPORTANT: PLEASE READ BEFORE USE!

ASSEMBLY

CAUTION! There are several areas during the assembly process of a treadmill that special attention must be paid. It is very important to follow the assembly instructions correctly and to make sure all parts are firmly tightened. If the assembly instructions are not followed correctly, the treadmill could have frame parts that are not tightened and will seem loose and may cause irritating noises. There should be no side-to-side play in the console masts or any forward and back play in the console assembly or handlebars. If there is any play in these areas, the treadmill has not been properly assembled. To prevent damage to the treadmill, the assembly instructions must be reviewed and corrective actions should be taken.

Before proceeding, find your treadmill's serial number and model name located to the left of the on/off power switch and power cord and enter it in the space provided below:

SERIAL NUMBER AND MODEL NAME LOCATION:

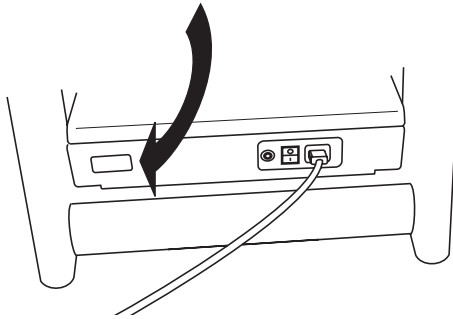

ENTER YOUR SERIAL NUMBER IN BOX BELOW:

Refer to this number when calling for service, and also enter this serial number on your Warranty Card and in your own records. Be sure to read the Safety Instructions and complete Owner's Guide before using your new treadmill.

WARRANTY REGISTRATION

Your warranty card must be completed and sent to Horizon Fitness within thirty days of purchase or registered on line at www.horizonfitness.com, before a warranty claim can be processed. Please keep receipt with owner's guide as it may be required for a warranty claim. Make sure to send in warranty registration card to validate your warranty.

FOLDING

Firmly grasp the back end of the treadmill. Carefully lift the end of the treadmill deck to the upright position until the foot lock latch engages and securely locks the deck into position. Make sure the deck is securely latched before letting go. To unfold, firmly grasp the back end of the treadmill. Gently press down on the foot lock latch with your foot until the lock latch disengages. Carefully lower the deck to the ground. **NOTE:** on the T20 model the foot lock latch might be on the right hand side.

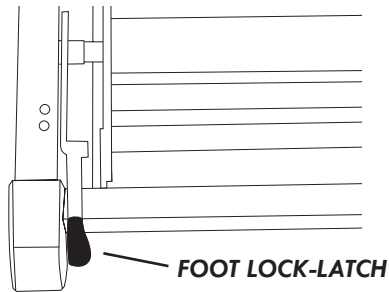

MOVING

Your treadmill has a pair of transport wheels built into the base frame. To move, make sure the treadmill is folded and securely latched. Then firmly grasp the handlebars, tilt the treadmill back and roll.

CAUTION! Our Treadmills are heavy, use care and additional help if necessary when moving. Do not attempt to move or transport treadmill unless it is in upright, folded position with the lock latch secured. Failure to follow these instructions could result in injury.

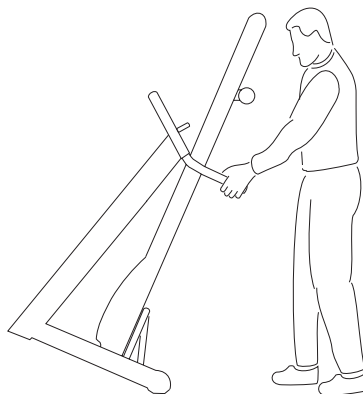

LEVELING

The treadmill should be level for optimum use. Once you have placed the treadmill where you intend to use it, raise or lower the adjustable levelers located on the treadmill base frame. Once you have leveled the treadmill, lock the levelers in place by tightening the nuts against the frame. To assure the treadmill is level, a carpenter's level is recommended. **NOTE: For the Horizon T20 leveling is not needed.**

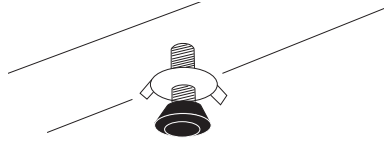

TURN POWER ON

Make sure that your treadmill is properly connected to a power outlet. The on/off switch is located next to the power cord. Flip this switch to the 'on' position, so that the switch is lit. You will hear a beep and the console will light up.

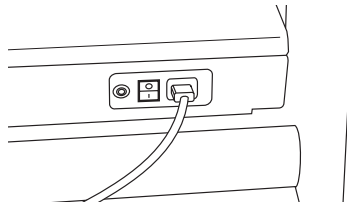

SAFETY KEY

Your treadmill will not start unless the safety key is placed on the safety key holder. Attach the clip end securely to your clothing. This safety key is designed to cut the power to the treadmill if you should fall. **NEVER USE THE TREADMILL WITHOUT SECURING THE SAFETY KEY CLIP TO YOUR CLOTHING. PULL ON THE SAFETY KEY CLIP FIRST TO MAKE SURE IT WILL NOT COME OFF YOUR CLOTHING.**

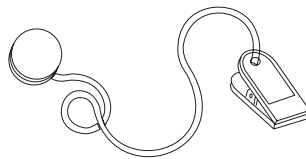

DO NOT STAND ON THE BELT

While you are preparing to use the treadmill, do not stand on the belt. Place your feet on the side rails before starting the treadmill. Start walking on the belt only after the belt has begun to move. Never start the treadmill at a fast running speed and attempt to jump on!

KNOW YOUR TREADMILL

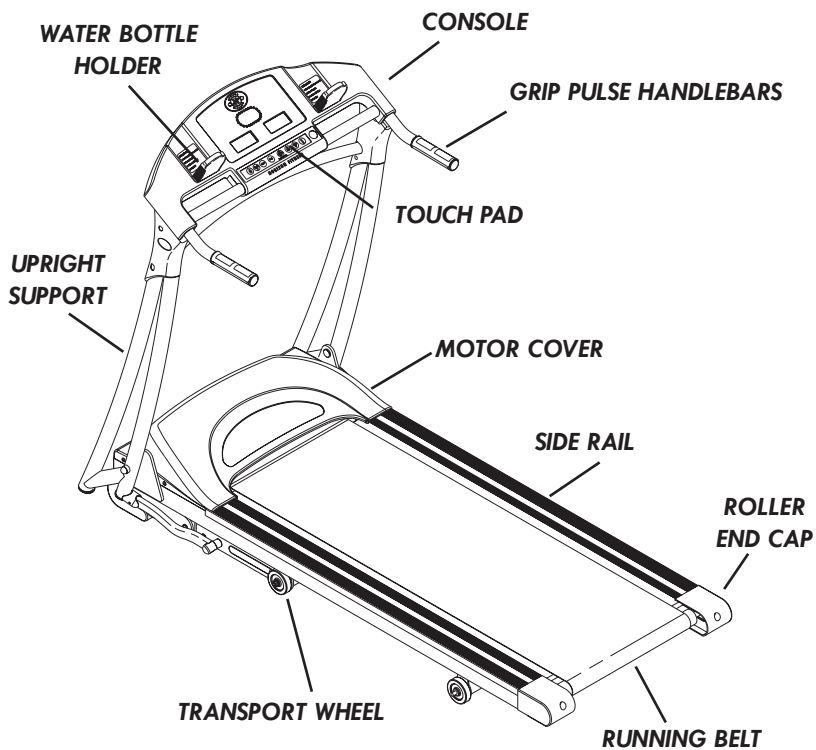

GETTING STARTED

QUICK START UP

Simply press the Start button to begin exercising.

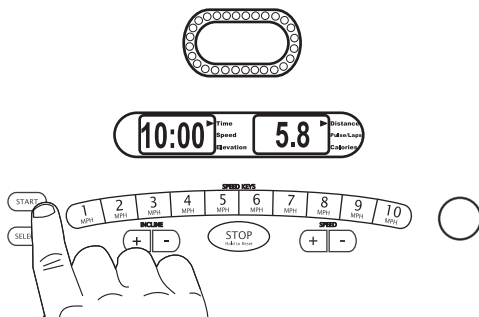

PAUSE

Press the Stop button to pause your workout.

RESET

Press and hold the Stop button to reset the treadmill.

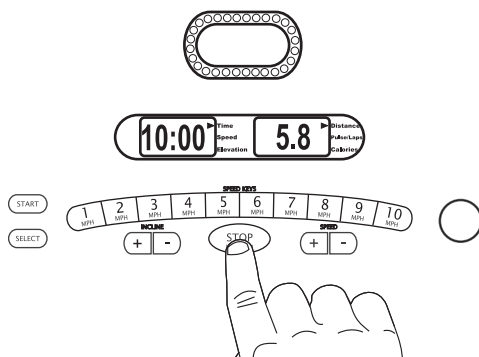

PROGRAMMING

CHOOSING THE TIME

Press SELECT and use the + or - buttons to set Time. Once the desired Time is selected, press the START button. Select your desired speed using the + or - (speed) buttons.

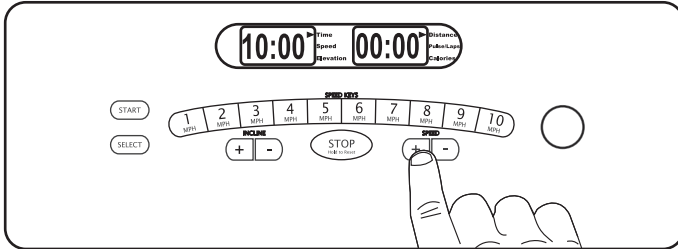

FINISHING A WORKOUT

When your workout is finished, the treadmill console will beep twice and 'END' will be displayed in the Time window. Your workout information will stay displayed on the console for 15 seconds before it will reset.



DISPLAY

SELECT

Used to view alternate information such as Speed, Pulse, Laps, Elevation, and Calories during your workout. Note: The console will automatically default back to show Time/Distance.

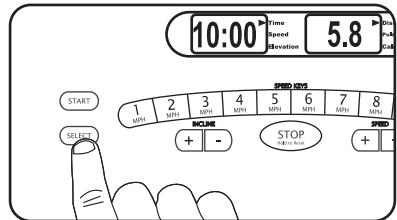

TIME

Show as Minutes:Seconds. View the time remaining or the time elapsed in your workout.



DISPLAY

SPEED

Indicates how fast your walking or running surface is moving.



ELEVATION

Indicates the incline of your walking or running surface.



DISTANCE

Indicates the miles traveled during your workout.



PULSE/LAPS

Indicates the number of times you have traveled around the lap profile window. One lap equals $\frac{1}{4}$ of a mile. Note: Pulse will be displayed if the heart rate handle-bars are being used. The pulse reading is measured in beats per minute.

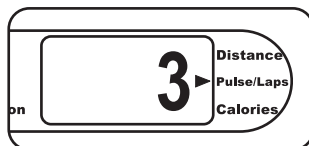

CALORIES

Indicates the total number of calories burned during your workout.



KNOW YOUR TREADMILL

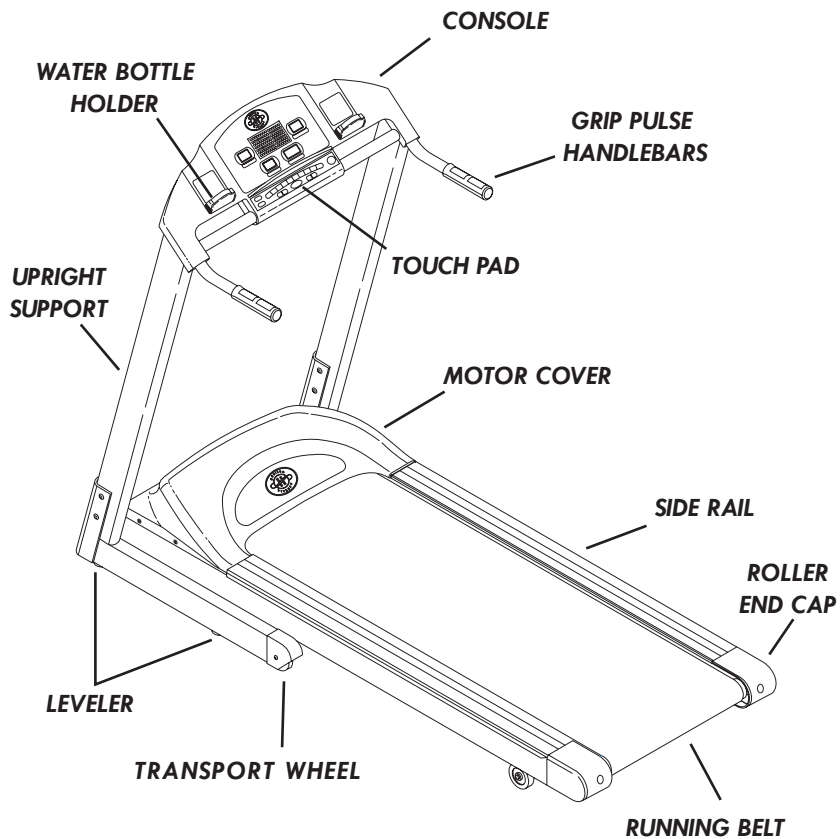

GETTING STARTED

QUICK START UP

Simply press the Start button to begin exercising.

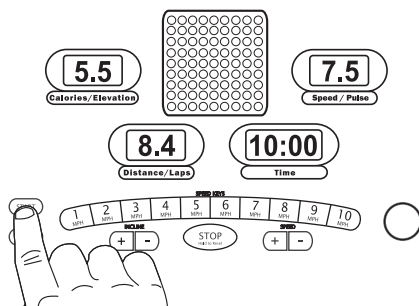

PAUSE

Press the Stop button to pause your workout.

RESET

Press and hold the Stop button to reset the treadmill.

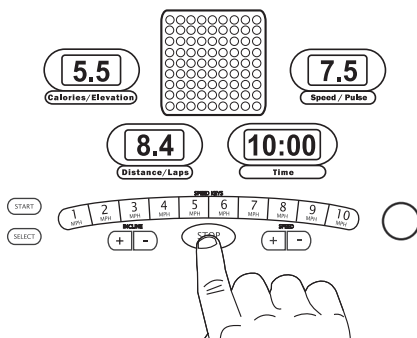

QUICK SPEED KEYS

When in a program, the user is able to press any of the desired quick speed keys to get to a specific speed more quickly. **NOTE:** When in a speed-based program, if the user presses any of the quick speed keys, all of the remaining speed segments in the program will be modified as well. For example, when in P2, the first segment default speed is 2.5 mph. If the user presses the 4 mph quick speed key, all of the remaining segments will increase by 1.5 mph as well.

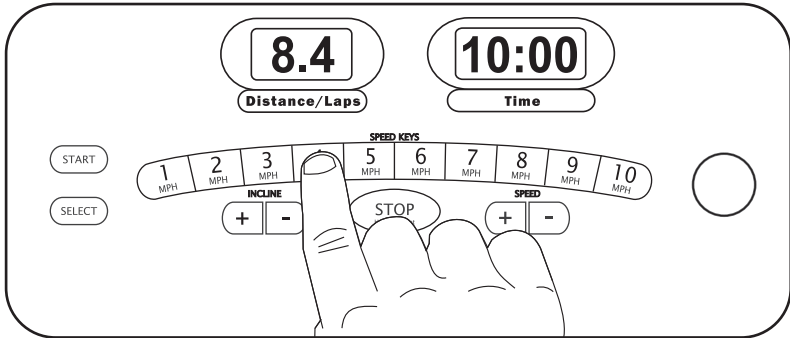

CHANGING THE SPEED AND ELEVATION

When in a program, the user is able to change the difficulty of the program by pressing the plus (+) or minus (-) buttons to the desired level. **NOTE:** The user is only able to increase or decrease the elevation or speed during the program. When in a program, if the user increases or decreases the difficulty of speed or elevation, all of the remaining program speeds or elevation segments will be modified as well. For example, when in P2, the first segment default speed is 2.5 mph. If this speed is increased by 1 mph, all of the remaining segments will be increased by 1 mph as well.

CHOOSING A PROGRAM

Choose a Program by pressing the + or - speed buttons. Once the desired program is selected, press the SELECT button. You are also able to press the numbered quick speed key which correlates with the numbered program to choose your desired program. For example press the number 1 quick-speed key for program number 1.

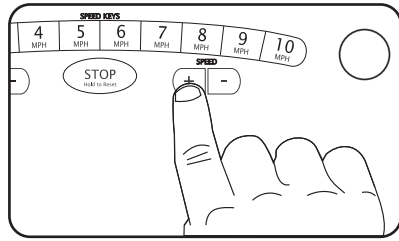

CHOOSING THE LEVEL

Choose the program difficulty level, level 1-10, by pressing the + or - speed buttons. Available only on certain programs. You may also choose your program level by pressing the numbered quick speed key that correlates with the program level number. For example, to choose a program level of 5, simply press quick speed key number 5. Once the program level has been chosen, press the 'select' button. Once in a program, the user may change the difficulty level by pressing the + or - speed keys or by pressing the quick speed keys. **NOTE:** If one segment is changed, the entire program will in turn be changed. For example, when in a program, if the user increases the speed 1 mph, all of the remaining segments will also be increased by 1 mph.

CHOOSING THE TIME

Choose Time by pressing the + or - speed buttons or use the default time. Once the desired time is selected, press the START button.

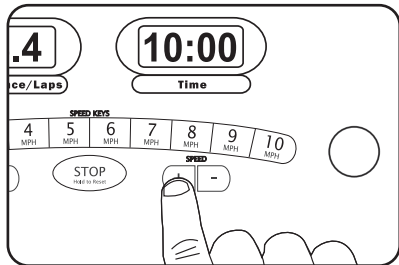

FINISHING A WORKOUT

When your workout is finished, the treadmill console will beep and 'END' will be flashing in the Time window. Your workout information will stay displayed on the console for 30 seconds before it will reset.

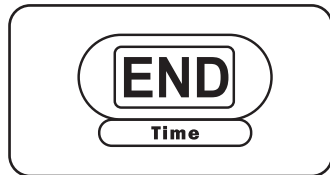

DISPLAY

SELECT

Used to view your Calories and Laps during your workout.

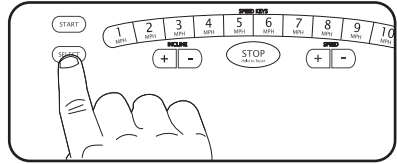

CALORIES

Total Calories burned during your workout.



DISTANCE

Miles traveled during your workout.



TIME

Shown as Minutes:Seconds. View the time remaining or the time elapsed in your workout.



PULSE

Shown as Beats Per Minute. Used to monitor your heart rate during your workout (displayed when contact is made with both grips or the chest strap is used).

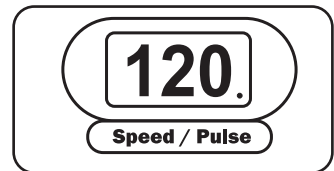

DISPLAY

ELEVATION

Shown in the top left-hand window. Indicates the incline of your walking or running surface.



SPEED

Shown in the top right-hand display window. Indicates how fast your walking or running surface is moving.

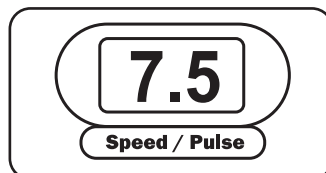

PROGRAM PROFILE

Represents the Program profile that you have chosen.

(Horizon T30 AND T40)

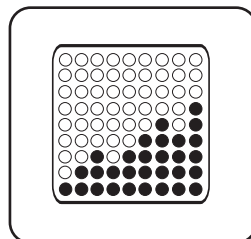

LAP PROFILE

(Horizon T20)

One lap around the profile window equals 1/4 of a mile. (Manual program only)

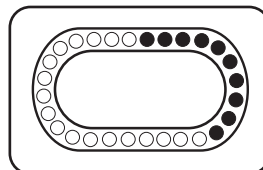

LAP PROFILE

One lap around the profile window equals 1/4 of a mile. (Manual program only)

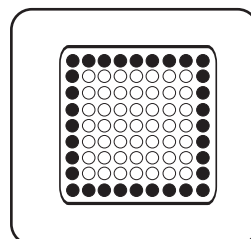

PROGRAM PROFILES

MANUAL

Customized workout, with no default time
(ALL HORIZON MODELS)



CROSS COUNTRY

Speed changes; time defaults to 30 minutes
(Horizon T30 AND T40)



HILL RUN

Speed changes; time defaults to 30 minutes
(Horizon T30 AND T40)



AFTER BURNER

Elevation changes; time defaults to 30 minutes
(Horizon T30 AND T40)



HILL CLIMB

Elevation and speed changes; time defaults to 30 minutes
(Horizon T30 AND T40)



PROGRAM PROFILES

ROCK CLIMB

Elevation and speed changes; time defaults to 30 minutes

(Horizon T30 AND T40)



RACE

Speed changes; time defaults to 30 minutes

(Horizon T30 AND T40)



PULSE Zone™

Elevation changes to keep you in your target heart rate; time defaults to 30 minutes

(Horizon T40)



ADVENTURE 1 (USER PROGRAM)

Customized workout, time defaults to 30 minutes

(Horizon T30 AND T40)



ADVENTURE 2 (USER PROGRAM)

Customized workout, time defaults to 30 minutes

(Horizon T40)



CROSS COUNTRY: Speed changes; time defaults to 30 minutes

Level 1	1	2	3	4	5	6	7	8	9	10	11	12	13	14	15	16	17	18	19	20	21	22	23	24	25	26	27	28	29	30
Level 1	2.5	3.0	3.0	4.5	3.0	4.0	3.0	5.0	3.0	5.0	3.0	5.0	3.5	5.0	3.5	5.0	3.5	5.0	3.5	5.0	3.0	5.0	3.0	5.0	3.0	4.5	3.0	4.0	3.0	2.5
Level 2	2.5	3.0	3.5	5.0	3.5	4.5	3.5	5.5	3.5	5.5	3.5	5.5	4.0	5.5	4.0	5.5	4.0	5.5	4.0	5.5	3.5	5.5	3.5	5.5	3.5	5.0	3.5	4.5	3.0	2.5
Level 3	2.5	3.0	4.0	5.5	3.5	5.5	3.5	6.0	4.0	6.0	4.0	6.0	4.5	6.0	4.5	6.0	4.5	6.0	4.5	6.0	4.0	6.0	4.0	6.0	3.5	5.5	3.5	4.5	3.0	2.5
Level 4	2.5	3.0	4.0	6.0	4.0	6.0	4.0	6.5	4.5	6.5	4.5	6.5	5.0	6.5	5.0	6.5	5.0	6.5	5.0	6.5	4.5	6.5	4.5	6.5	4.0	6.0	4.0	4.5	3.0	2.5
Level 5	2.5	3.5	4.5	6.5	4.5	6.5	4.5	7.0	5.0	7.0	5.0	7.0	5.5	7.0	5.5	7.0	5.5	7.0	5.5	7.0	5.0	7.0	5.0	7.0	4.5	6.5	4.5	5.0	3.0	2.5
Level 6	2.5	3.5	5.0	7.0	5.0	7.0	5.0	7.5	5.5	7.5	5.5	7.5	6.0	7.5	6.0	7.5	6.0	7.5	6.0	7.5	6.5	7.5	5.5	7.5	5.0	7.0	5.0	5.0	3.0	2.5
Level 7	2.5	3.5	5.5	7.5	5.5	7.5	5.5	8.0	6.0	8.0	6.0	8.0	8.0	8.0	6.5	8.0	6.5	8.0	6.5	8.0	6.0	8.0	6.0	8.0	5.5	7.5	5.5	5.0	3.0	2.5
Level 8	2.5	4.0	6.0	8.0	6.0	8.0	6.0	8.5	6.5	8.5	6.5	8.5	7.0	8.5	7.0	8.5	7.0	8.5	7.0	8.5	6.5	8.5	6.5	8.0	5.5	8.0	6.0	5.0	3.0	2.5
Level 9	2.5	4.0	6.5	8.5	6.5	8.5	6.5	9.0	7.0	9.0	7.0	9.0	9.0	7.5	9.0	7.5	9.0	7.5	9.0	7.0	9.0	7.0	9.0	8.5	6.0	8.5	6.0	5.0	3.0	2.5
Level 10	2.5	4.0	7.0	9.0	7.0	9.0	7.0	9.5	7.5	9.5	7.5	9.5	9.5	8.0	9.5	8.0	9.5	8.0	9.5	8.0	9.5	7.5	9.5	9.0	6.5	9.0	6.5	5.0	3.0	2.5

HILL RUN: Speed changes; time defaults to 30 minutes

Level 1	1	2	3	4	5	6	7	8	9	10	11	12	13	14	15	16	17	18	19	20	21	22	23	24	25	26	27	28	29	30	
Level 1	2.5	3.0	3.0	3.5	3.0	3.5	4.5	5.0	4.5	5.0	4.5	5.0	4.5	5.0	4.5	5.0	4.5	5.0	4.5	5.0	4.5	5.0	4.5	5.0	3.5	3.0	3.5	3.0	2.5		
Level 2	2.5	3.0	3.0	3.5	3.0	3.5	5.0	5.5	5.0	5.5	5.0	5.5	5.0	5.5	5.0	5.5	5.0	5.5	5.0	5.5	5.0	5.5	5.0	3.5	3.0	3.5	3.0	2.5			
Level 3	2.5	3.0	3.5	4.0	3.5	4.0	5.5	6.0	5.5	6.0	5.5	6.0	5.5	6.0	5.5	6.0	5.5	6.0	5.5	6.0	5.5	6.0	5.5	4.0	3.5	4.0	3.5	3.0	2.5		
Level 4	2.5	3.0	4.0	4.5	4.0	4.5	6.0	6.5	6.0	6.5	6.0	6.5	6.5	6.5	6.0	6.5	6.0	6.5	6.0	6.5	6.0	6.5	6.0	4.5	4.0	4.5	4.0	3.5	3.0	2.5	
Level 5	2.5	3.5	4.5	5.0	4.5	5.0	6.5	7.0	6.5	7.0	6.5	7.0	6.5	7.0	6.5	7.0	6.5	7.0	6.5	7.0	6.5	7.0	6.5	5.0	4.5	5.0	4.5	3.0	2.5		
Level 6	2.5	3.5	5.0	5.5	5.0	5.5	7.0	7.5	7.0	7.5	7.0	7.5	7.0	7.5	7.0	7.5	7.0	7.5	7.0	7.5	7.0	7.5	7.0	5.5	5.0	5.5	5.0	4.5	3.0	2.5	
Level 7	2.5	3.5	5.5	6.0	5.5	6.0	7.5	8.0	7.5	8.0	7.5	8.0	7.5	8.0	7.5	8.0	7.5	8.0	7.5	8.0	7.5	8.0	7.5	6.0	5.5	6.0	5.5	5.0	3.0	2.5	
Level 8	2.5	4.0	6.0	6.5	6.0	6.5	8.0	8.5	8.0	8.5	8.0	8.5	8.0	8.5	8.0	8.5	8.0	8.5	8.0	8.5	8.0	8.5	8.0	6.5	6.0	6.5	6.0	5.0	3.0	2.5	
Level 9	2.5	4.0	6.5	7.0	6.5	7.0	8.5	9.0	8.5	9.0	8.5	9.0	8.5	9.0	8.5	9.0	8.5	9.0	8.5	9.0	8.5	9.0	8.5	7.0	6.5	7.0	6.5	5.0	3.0	2.5	
Level 10	2.5	4.0	7.0	7.5	7.0	7.5	9.0	9.5	9.0	9.5	9.0	9.5	9.0	9.5	9.0	9.5	9.0	9.5	9.0	9.5	9.0	9.5	9.0	7.5	7.0	7.5	7.0	6.5	5.0	3.0	2.5

AFTER BURNER: Elevation changes; time defaults to 30 minutes

	1	2	3	4	5	6	7	8	9	10	11	12	13	14	15	16	17	18	19	20	21	22	23	24	25	26	27	28	29	30
Level 1	0.5	1.0	1.5	2.0	2.0	2.5	3.0	3.0	3.5	3.5	4.0	4.0	4.5	4.5	4.5	4.0	4.0	3.5	3.5	3.0	3.0	3.0	2.5	2.5	2.0	2.0	1.5	1.5	1.0	0.5
Level 2	1.0	1.5	2.0	2.5	3.0	3.0	3.5	4.5	5.0	4.5	5.0	4.5	4.5	4.5	4.0	4.0	3.5	4.0	4.0	3.5	3.5	3.0	2.5	2.5	2.0	2.0	1.5	1.0	0.5	
Level 3	1.5	2.0	2.5	3.0	3.0	3.5	3.5	4.0	4.0	4.5	5.0	5.0	5.5	5.5	5.0	5.0	4.5	4.0	4.0	3.5	3.5	3.0	2.5	2.5	2.0	1.5	1.0	0.5	0.0	
Level 4	2.0	2.5	3.0	3.5	4.0	4.0	4.5	4.5	5.0	5.5	5.5	5.5	5.5	5.5	5.0	4.5	4.0	4.0	3.5	3.5	3.0	2.5	2.5	2.0	1.5	1.0	0.5	0.0	0.0	
Level 5	2.5	3.5	3.5	4.0	4.0	4.5	4.5	5.0	5.0	5.5	5.5	6.0	6.0	6.5	6.5	6.0	5.5	5.0	4.5	4.0	4.0	3.5	3.0	2.5	2.0	1.5	1.0	0.5	0.0	
Level 6	2.5	3.5	4.0	4.5	4.5	5.0	5.0	5.5	5.5	6.0	6.5	6.5	7.0	7.0	7.5	7.5	7.0	6.5	6.0	5.5	5.0	4.5	4.0	3.5	3.0	2.5	2.0	1.5	1.0	0.5
Level 7	2.5	3.5	4.5	5.0	5.0	5.5	5.5	6.0	6.0	6.5	7.0	7.0	7.5	7.5	7.0	7.0	6.5	6.0	5.5	5.0	4.5	4.0	3.5	3.0	2.5	2.0	1.5	1.0	0.5	0.0
Level 8	2.5	4.0	4.5	5.5	5.5	6.0	6.0	6.5	6.5	7.0	7.5	7.5	8.0	8.0	8.5	8.5	8.0	7.5	7.5	7.0	6.5	6.0	5.5	5.0	4.5	4.0	3.5	3.0	2.5	2.0
Level 9	2.5	4.0	5.5	6.0	6.0	6.5	6.5	7.0	7.5	7.5	8.0	8.0	8.5	8.5	8.0	8.0	7.5	7.0	7.0	6.5	6.0	5.5	5.0	4.5	4.0	3.5	3.0	2.5	2.0	1.5
Level 10	2.5	4.0	5.5	6.5	6.5	7.0	7.0	7.5	8.0	8.0	8.5	8.5	9.0	9.0	9.0	8.5	8.5	8.0	8.0	7.5	7.5	7.0	6.5	6.0	5.5	5.0	4.5	4.0	3.0	2.5

HILL CLIMB: Elevation and speed changes; time defaults to 30 minutes

	1	2	3	4	5	6	7	8	9	10	11	12	13	14	15	16	17	18	19	20	21	22	23	24	25	26	27	28	29	30
Level 1	elevation	0.0	0.0	0.0	0.0	0.5	0.5	0.5	0.5	0.5	0.0	0.0	0.0	0.5	0.5	0.5	0.0	0.0	0.0	0.5	0.5	0.5	0.5	0.5	0.0	0.0	0.0	0.0	0.0	
Level 2	Speed	2.5	3.0	3.0	3.5	3.0	3.5	4.5	5.0	4.5	5.0	4.5	5.0	4.5	5.0	4.5	5.0	4.5	5.0	4.5	5.0	4.5	5.0	4.5	3.5	3.0	3.5	3.0	2.5	
Level 3	elevation	0.0	0.0	0.0	0.0	0.5	0.5	0.5	0.5	0.5	0.5	0.5	0.5	0.5	0.5	0.5	0.5	0.5	0.5	0.5	0.5	0.5	0.5	0.5	0.0	0.0	0.0	0.0	0.0	
Level 4	Speed	2.5	3.0	3.0	3.5	3.0	3.5	5.0	5.5	5.0	5.5	5.0	5.5	5.0	5.5	5.0	5.5	5.0	5.5	5.0	5.5	5.0	3.5	3.0	3.5	3.0	3.0	2.5	2.0	
Level 5	elevation	0.5	0.5	0.5	0.5	1.0	1.0	1.0	1.0	1.0	0.5	0.5	0.5	0.5	1.0	1.0	1.0	0.5	0.5	1.0	1.0	1.0	1.0	1.0	0.5	0.5	0.5	0.5	0.5	
Level 6	Speed	2.5	3.5	4.5	5.0	4.5	5.0	6.0	7.0	6.5	7.0	6.5	7.0	6.5	7.0	6.5	7.0	6.5	7.0	6.5	7.0	6.5	5.0	4.5	5.0	4.5	4.5	3.0	2.5	
Level 7	elevation	1.0	1.0	1.0	1.0	1.5	1.5	1.0	1.0	1.0	1.5	1.5	1.5	1.5	1.0	1.0	1.0	1.5	1.5	1.0	1.0	1.0	1.0	1.0	0.5	0.5	0.5	0.5	0.5	
Level 8	Speed	2.5	3.5	5.0	5.5	6.0	5.5	7.0	7.5	7.0	7.5	7.0	7.5	7.0	7.5	7.0	7.5	7.0	7.5	7.0	7.5	7.0	5.5	5.0	4.5	4.0	4.5	3.0	2.5	
Level 9	elevation	1.0	1.0	1.0	1.0	1.5	1.5	1.0	1.0	1.0	1.5	1.5	1.5	1.5	1.0	1.0	1.0	1.5	1.5	1.0	1.0	1.0	1.0	1.0	0.5	0.5	0.5	0.5	0.5	
Level 10	Speed	2.5	4.0	6.5	7.0	6.5	7.0	8.5	9.0	8.5	9.0	8.5	9.0	8.5	9.0	8.5	9.0	8.5	9.0	8.5	9.0	8.5	7.0	6.5	5.0	4.5	4.0	3.0	2.5	

ROCK CLIMB: Elevation and speed changes; time defaults to 30 minutes

	1	2	3	4	5	6	7	8	9	10	11	12	13	14	15	16	17	18	19	20	21	22	23	24	25	26	27	28	29	30	
Level 1	elevation	0.5	1.0	1.5	2.0	2.0	2.5	2.5	3.0	3.0	3.5	3.5	4.0	4.0	4.5	4.5	4.0	4.0	3.5	3.0	3.0	2.5	2.5	2.0	2.0	1.5	1.5	1.0	0.5		
	Speed	2.5	3.0	3.0	4.5	3.0	4.0	3.0	5.0	3.0	5.0	3.0	5.0	3.0	5.0	3.5	5.0	3.5	5.0	3.5	5.0	3.0	3.0	5.0	3.0	4.5	3.0	4.0	3.0	2.5	
Level 2	elevation	1.0	1.5	2.0	2.5	2.5	3.0	3.0	3.5	3.5	4.0	4.0	4.5	4.5	5.0	5.0	4.5	4.0	3.5	3.0	3.0	2.5	2.5	2.0	2.0	1.5	1.0				
	Speed	2.5	3.0	3.5	5.0	3.5	4.5	3.5	5.5	3.5	5.5	3.5	5.5	4.0	5.5	4.0	5.5	4.0	5.5	3.5	5.5	3.5	5.5	3.5	5.0	3.0	4.5	3.0	2.5		
Level 3	elevation	1.5	2.0	2.5	3.0	3.0	3.5	3.5	4.0	4.0	4.5	4.5	5.0	5.0	5.5	5.5	5.0	4.5	4.0	3.5	3.0	3.0	2.5	2.5	2.0	1.5					
	Speed	2.5	3.0	4.0	5.5	3.5	5.5	3.5	6.0	4.0	6.0	4.0	6.0	4.5	6.0	4.5	6.0	4.5	6.0	4.0	6.0	4.0	6.0	4.0	3.5	3.5	3.5	4.5	3.0	2.5	
Level 4	elevation	2.0	2.5	3.0	3.5	3.5	4.0	4.0	4.5	4.5	5.0	5.0	5.5	5.5	6.0	6.0	5.5	5.0	4.5	4.0	3.5	3.0	3.0	2.5	2.0	1.5					
	Speed	2.5	3.5	4.5	6.5	4.5	6.5	4.5	7.0	5.0	7.0	5.0	7.0	5.5	7.0	5.5	7.0	5.5	7.0	5.0	6.5	5.0	6.5	4.5	6.5	4.0	6.0	4.0	4.5	3.0	2.5
Level 5	elevation	2.5	3.5	3.5	4.0	4.0	4.5	4.5	5.0	5.0	5.5	5.5	6.0	6.0	6.5	6.5	6.0	5.5	5.0	4.5	4.0	3.5	3.0	3.0	2.5	2.0	1.5				
	Speed	2.5	3.5	4.5	6.5	4.5	6.5	4.5	7.0	5.0	7.0	5.0	7.0	5.5	7.0	5.5	7.0	5.5	7.0	5.0	6.5	5.0	6.5	4.5	6.5	4.0	6.0	4.0	4.5	3.0	2.5
Level 6	elevation	2.5	3.5	4.0	4.5	4.5	5.0	5.0	5.5	5.5	6.0	6.0	6.5	6.5	7.0	7.0	6.5	6.0	5.5	5.0	4.5	4.0	3.5	3.0	2.5	2.0	1.5				
	Speed	2.5	3.5	5.0	7.0	5.0	7.0	5.0	7.5	5.5	7.5	5.5	7.5	6.0	7.5	6.0	7.5	6.0	7.5	6.0	7.5	5.5	7.5	5.0	7.0	5.0	5.0	3.0	2.5		
Level 7	elevation	2.5	3.5	4.5	5.0	5.0	5.5	5.5	6.0	6.0	6.5	6.5	7.0	7.0	7.5	7.5	7.0	6.5	6.0	5.5	5.0	4.5	4.0	3.5	3.0	2.5	2.0	1.5			
	Speed	2.5	3.5	5.5	7.5	5.5	7.5	5.5	8.0	6.0	8.0	6.0	8.0	6.5	8.0	6.5	8.0	6.5	8.0	6.5	8.0	6.0	8.0	6.0	8.0	5.5	5.0	4.5	3.0	2.5	
Level 8	elevation	2.5	4.0	4.5	5.5	5.5	6.0	6.0	6.5	6.5	7.0	7.0	7.5	7.5	8.0	8.0	7.5	7.0	6.5	6.0	5.5	5.0	4.5	4.0	3.5	3.0	2.5	2.0	1.5		
	Speed	2.5	4.0	6.0	8.0	6.0	8.0	6.0	8.5	6.5	8.5	6.5	8.5	7.0	8.5	7.0	8.5	7.0	8.5	7.0	8.5	6.5	8.0	5.5	8.0	6.0	6.0	5.0	3.0	2.5	
Level 9	elevation	2.5	4.0	5.5	6.0	6.0	6.5	6.5	7.0	7.0	7.5	7.5	8.0	8.0	8.5	8.5	8.0	7.5	7.0	6.5	6.0	5.5	5.0	4.5	4.0	3.5	3.0	2.5	2.0	1.5	
	Speed	2.5	4.0	6.5	8.5	6.5	8.5	6.5	9.0	7.0	9.0	7.0	9.0	7.5	9.0	7.5	9.0	7.5	9.0	7.5	9.0	7.5	9.0	7.0	8.5	6.0	8.5	6.0	5.0	3.0	2.5
Level 10	elevation	2.0	4.0	6.0	6.5	6.5	7.0	7.0	7.5	7.5	8.0	8.0	8.5	8.5	9.0	9.0	8.5	8.0	7.5	7.0	6.5	6.0	5.5	5.0	4.5	4.0	3.0	2.5	2.0	1.5	
	Speed	2.5	4.0	7.0	9.0	7.0	9.0	7.0	9.5	7.5	9.5	7.5	9.5	8.0	9.5	8.0	9.5	8.0	9.5	8.0	9.5	7.5	9.5	7.5	9.0	6.5	8.5	6.5	5.0	3.0	2.5

USING YOUR RACE PROGRAM

Your Race Program is designed to add motivation to a workout by allowing you to compete against a selected pacer. To use your Race Program, follow these instructions:

- 1.** Once the Race Program is selected, Press 'Select'.
- 2.** Choose the desired Pace (speed) using the + or - speed or incline keys and press 'Select'. The selected pace is **the pace** you will be racing against. **You will** choose your own speed **after** the program started.
- 3.** To choose your desired distance press the + or - speed or incline keys and press 'Select'. **NOTE:** your program time will be set according to your speed and distance.
- 4.** Once the desired Pace (Speed) and distance has been chosen, press the 'Start' key.
- 5.** Upon pressing 'Start', the program will be broken up into 10 segments (which will not be displayed on console as 8 LED lights). The first segment will be dedicated to a warm up, which will be half of the selected pace (Speed) and will be set at 2.5 minutes. Segments 2-9 will consist of the Race Program, with segment 10 being dedicated to a cool down period, which again will be half of the selected Pace (Speed) segment will not be displayed. If the user beats the pacer to the finish line, the speed window will flash, and the program will end.
- 6.** You can adjust the your own speed at any time during the program by pressing the + or - speed keys or by using the quick speed keys.

USING YOUR PULSE Zone™ PROGRAM

(T40 MODEL ONLY)

Once the 'THR Zone' quick program key is selected, wait for 5 seconds and you will see the target heart rate flashing in the Heart Rate window. Using the chart on page 26, determine your target heart rate. Your target heart rate should be set at a number that you will be able to exercise at throughout the majority of your workout. To adjust the target heart rate, press the plus (+) or minus (-) buttons.

Once you have chosen your target heart rate, wait for five seconds and you will see the time flashing in the Time window. Press the plus (+) or minus (-) buttons to adjust your time. Once you choose your time, press the 'Start' button and begin your workout.

The 'THR Zone' program will have a 5 minute warm up time before it will get you in your 'target heart rate zone'.

After the 5 minute warm up period, the resistance level will increase gradually to get the user to the entered 'target heart rate zone'. Once the user is at the 'target heart rate zone', plus or minus 5 beats, the resistance level will remain at the current resistance level.

The last 5 minutes of the program will begin the cool down period. At this time, the program will gradually decrease the resistance level to give the user a smooth cool down.

NOTE: The Chest Strap Transmitter is required to use the 'THR Zone' program.

CHEST STRAP TRANSMITTER PLACEMENT AND MOISTENING THE ELECTRODES

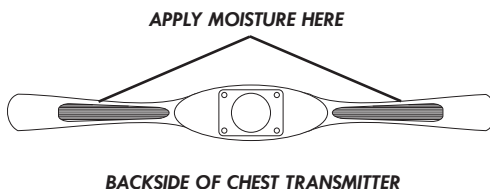
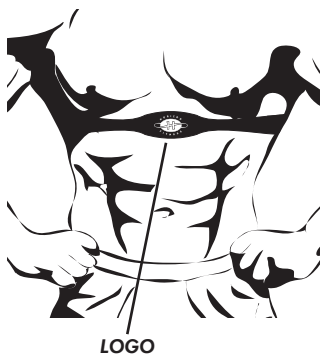

TARGET ZONE

Your Target Zone is a percentage of your maximum heart rate. Target Zone will vary for each individual, depending on age, current level of conditioning, and personal fitness goals. The American Heart Association recommends working-out at a Target Heart Rate Zone of between 60% and 75% of your maximum heart rate. See the chart below for convenient reference.

EXAMPLE: for a 42-year old user: find AGE along the bottom of the chart (round to 40), follow AGE column up to the TARGET ZONE BAR. RESULTS: 60% of maximum Heart Rate = 108 Beats Per Minute, 75% of maximum Heart Rate = 135 Beat Per Minute.

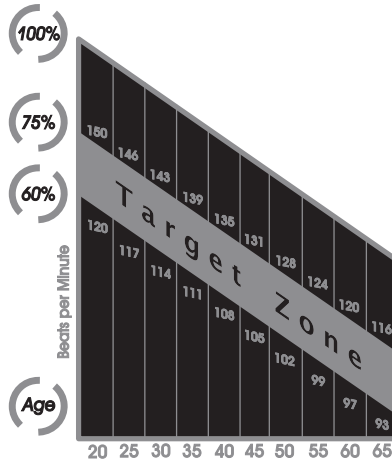

HEART RATE HANDLEBARS

Place the palm of your hands directly on the grip pulse handlebars. Both hands must grip the bars for your heart rate to register. When gripping the pulse handlebars, do not grip tightly. Holding the grips tightly may elevate your blood pressure. Keep a loose, cupping hold. It is recommended that you hold the grip pulse handlebars only long enough to see your heart rate readout on the console. You may experience an erratic readout if consistently holding the grip pulse handlebars.

TELEMETRIC CHEST TRANSMITTER (OPTIONAL)

Prior to wearing the chest transmitter on your chest, moisten the two rubber electrodes with water. Center the chest strap just below the breast or pectoral muscles, directly over your sternum, **NOTE:** The chest strap must be tight and properly placed to receive an accurate and consistent readout. If the chest strap is too loose, or positioned improperly, you may receive an erratic or inconsistent heart rate readout. **WARNING!** The heart rate function is not a medical device. Various factors may affect the accuracy of your heart rate reading. The heart rate reading is intended only as an exercise aid.

NOTE: *Horizon T40 MODEL ONLY.*

USING YOUR ADVENTURE PROGRAM

Your Adventure Program is designed to allow you to create your own programming, with the ability to save your program settings for future workouts. To use your Adventure Program, follow these instructions:

- 1.** Once the Adventure Program has been selected, press 'Select'.
- 2.** Choose your desired time using the + or - speed or incline keys and press 'Select'.
- 3.** Choose your desired speed using the + or - speed or incline keys and press 'Select'. You will need to select a speed for all 15 segments, pressing 'Select' after each segment.
- 4.** Once all 15 speed segments have been chosen, you will need to select your desired incline level for each segment as well. Choose your desired incline level using the + or - speed or incline keys and press 'Select'. Once you have chosen your desired incline level for all 15 segments, press 'Start' to begin your program. At this time, your program has been successfully saved into memory, and can be used for future workouts.
- 5.** To reset your program information and delete it from memory, press and hold the 'Select' button for 5 seconds once you have selected the Adventure Program in the start menu.
- 6.** While using your saved program in the Adventure Program, you are able to adjust the speed or incline, but any changes will not be saved.

TROUBLESHOOTING YOUR TREADMILL

Horizon Fitness treadmills are designed to be reliable and easy to use. However, if you experience a problem, please reference the troubleshooting guide listed below.

PROBLEM: The console does not light up.

SOLUTION: Verify that the power cord is plugged in properly to the outlet, and that the treadmill switch is turned on.

PROBLEM: The treadmill circuit breaker trips during a workout.

SOLUTION: Verify that the treadmill is plugged into a dedicated 20amp circuit.

NOTE: no extension cord.

PROBLEM: The treadmill shuts off when elevating

SOLUTION: Verify that there is enough slack in the power cord to reach to the wall outlet during elevation.

PROBLEM: The running belt does not stay centered during a workout.

SOLUTION: Verify that the treadmill is on a level surface. Verify that the belt is properly tightened (refer to Centering The Belt.)

PROBLEM: The treadmill makes a clicking noise towards the front of the machine while walking or running on it.

SOLUTION: For optimum use, the treadmill needs to be level. Refer to the section on leveling your treadmill.

HEART RATE TROUBLESHOOTING

Check your exercise environment for sources of interference such as fluorescent lights, computers, or appliances containing large motors. These items may cause erratic heart rate readouts.

You may experience an erratic readout under the following conditions:

- Gripping the heart rate handlebars too tight. Try to maintain moderate pressure while holding onto the heart rate handlebars.

- **Constant movement and vibration due to constantly holding the heart rate handlebars while exercising. If you are receiving erratic heart rate readouts, try to only hold the grips long enough to monitor your heart rate.**
- **When you are breathing heavily during a workout.**
- **When your hands are constricted by wearing a ring.**
- **When your hands are dry or cold. Try to moisten your palms by rubbing them together to warm.**
- **Anyone with heavy arrhythmia.**
- **Anyone with arteriosclerosis or peripheral circulation disorder.**
- **Anyone whose skin on the measuring palm is especially thick.**

PROBLEM: There is no heart rate reading.

SOLUTION: If you are using the chest strap, there may be a poor connection between the electrodes and the skin. Remoisten the electrodes with water.

SOLUTION: The chest strap may not be positioned properly. Reposition the chest strap. It may be necessary to experiment with the fit and position of the chest strap.

SOLUTION: Verify that the distance between the chest strap and the console is not beyond the recommended range of 36 inches.

SOLUTION: The battery in the chest strap may be dead. Take the chest strap to a jewelry store or return to Horizon Fitness for a battery replacement.

PROBLEM: Erratic or inconsistent readout.

SOLUTION: This is often caused by dry electrodes or a loose chest strap. Moisture on the rubber electrodes is required for proper operation. Try a more generous coating of water on the electrodes and tightening the chest strap.

If the above troubleshooting section does not remedy the problem, discontinue use and turn the power off.

**DO NOT RETURN TO THE STORE, PLEASE CONTACT THE HORIZON FITNESS
CUSTOMER ASSISTANCE CENTER;
TOLL FREE @ 1-888-993-3199.**

COMMON PRODUCT QUESTIONS

ARE THE SOUNDS MY TREADMILL MAKES NORMAL?

All treadmills make a certain type of thumping noise due to the belt riding over the rollers, especially new treadmills. This noise will diminish over time, although may not totally go away. Over time, the belt will stretch, causing the belt to ride smoother over the rollers.

WHY IS THE TREADMILL I HAD DELIVERED LOUDER THAN THE ONE AT THE STORE?

All fitness products seem quieter in a large store showroom because there is generally more background noise than in your home. Also, there will be less reverberation on a carpeted concrete floor than on a wood overlay floor. Sometimes a heavy rubber mat will help reduce reverberation through the floor. If a fitness product is placed close to a wall, there will be more reflected noise.

WHEN SHOULD I BE WORRIED ABOUT A NOISE?

As long as the sounds your treadmill makes are no louder than a normal conversational tone of voice, it is considered normal noise. If your treadmill is louder than this, you may want to call the Horizon Fitness Customer Service Center @ 1.888.993.3199. Sometimes an initial diagnosis can be made over the phone.

MAINTENANCE

WHAT KIND OF ROUTINE MAINTENANCE IS REQUIRED?

We use sealed bearings throughout our treadmill so lubrication is not needed. The most important maintenance step is to simply wipe your perspiration off the treadmill after each use.

HOW DO I CLEAN MY TREADMILL?

Clean with soap and water cleaners only. Never use solvents on plastic parts.

TENSIONING THE BELT

If you can feel a slipping sensation when running on the treadmill, the running belt must be tightened. In most cases, the belt has stretched from use, causing the belt to slip. This is a normal and common adjustment. To eliminate this slipping, tension both the rear roller bolts with the appropriate size allen wrench, turning it 1/4 TURN to the right as shown. Try the treadmill again to check for slipping. Repeat if necessary, but NEVER TURN the roller bolts more than 1/4 turn at a time. the belt tension is set properly when the running belt is 1/4 of an inch from the deck.

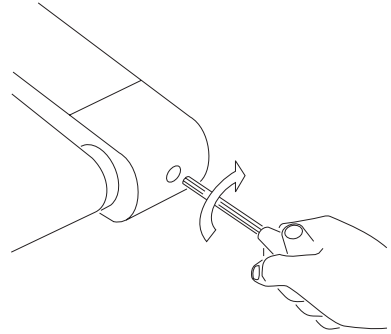

CENTERING THE BELT

If the running belt is too far to the right side, use the supplied Allen wrench to turn the right tension bolt clockwise 1/4 turn at a time until the belt remains centered during use.

If the running belt is too far to the left side, turn the left tension bolt clockwise 1/4 turn at a time until the belt remains centered during use.

IF THE BELT IS TOO FAR TO THE LEFT SIDE:

- Turn the left roller bolt 1/4 turn clockwise (tighten).

IF THE BELT IS TOO FAR TO THE RIGHT SIDE:

- Turn the right roller bolt 1/4 turn clockwise (tighten).

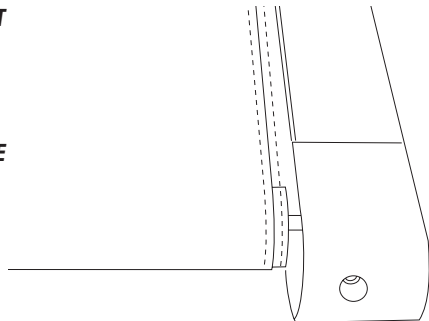

MAINTENANCE PROCEDURES

TIPS

Cleanliness of your treadmill and its operating environment will keep maintenance problems and service calls to a minimum. For this reason, Horizon Fitness recommends that the following preventive maintenance schedule be followed.

AFTER EACH USE

Turn off the treadmill with the on/off switch, and unplug the power cord from the wall outlet.

WARNING!

To remove power from the treadmill, the power cord must be disconnected from the wall outlet.

- Wipe down the running belt, deck, motor cover, and console casing with a damp cloth. Never use solvents, as they can cause damage to the treadmill.
- Inspect the power cord. If the power cord is damaged, contact Horizon Fitness.
- Make sure the power cord is not underneath the treadmill or in any other area where it can become pinched or cut.
- Check the tension and alignment of the running belt. Make sure that the treadmill belt will not damage any other components on the treadmill by being misaligned.

EVERY WEEK

Clean underneath the treadmill, following these steps:

- Turn off the treadmill with the on/off switch, then unplug the power cord at the wall outlet.
- Fold the treadmill into the upright position, making sure that the lock latch is secure.
- Move the treadmill to a remote location.
- Wipe or vacuum any dust particles or other objects that may have accumulated underneath the treadmill.
- Return the treadmill to its previous position.

EVERY MONTH

- Inspect all assembly bolts of the machine for proper tightness.
- Remove the motor cover and clean the motor and lower board area to eliminate any lint or dust particles that may have accumulated. Failure to do so may result in premature failure of key electrical components.

EVERY YEAR

- It may be necessary to rewax your treadmill running deck and belt once a year to maintain optimal performance of your treadmill. Please contact Horizon Fitness with questions about applying wax to your treadmill.

Warning! Only use paraffin wax provided by Horizon Fitness!

- Lubricate the air shocks with teflon based spray.

EXERCISE GUIDELINES

Always consult your physician before beginning an exercise program.

HOW OFTEN?

The American Heart Association recommends that you exercise at least 3 to 4 days per week to maintain cardiovascular fitness. If you have other goals such as weight or fat loss, you will achieve your goal faster with more frequent exercise. Whether it's 3 days or 6 days, remember that your ultimate goal should be to make exercise a lifetime habit. Many people are successful staying with a fitness program if they set aside a specific time of day to exercise. It doesn't matter whether it's in the morning before your shower, during lunch hour or while watching the evening news. What's more important is that it's a time that allows you to keep a schedule, and a time when you won't be interrupted. If you are to be successful with your fitness program, you have to make it a priority in your life. So decide on a time, pull out your day planner and pencil in your exercise times for the next month!

HOW LONG?

For aerobic exercise benefits, it's recommended that you exercise from between 24 and 32 minutes per session. But start slowly and gradually increase your exercise times. If you've been sedentary during the past year, it may be a good idea to keep your exercise times to as little as five minutes initially. Your body will need time to adjust to the new activity. If your goal is weight loss, a longer exercise session at lower intensities has been found to be most effective. A workout time of 48 minutes or more is recommended for best weight loss results.

HOW HARD?

How hard you workout is also determined by your goals. If you use your treadmill to prepare for a 5K run, you will probably work out at a higher intensity than if your goal is general fitness. Regardless of your long term goals, always begin an exercise program at low intensity. Aerobic exercise does not have to be painful to be beneficial! There are two ways to measure your exercise intensity. The first is by monitoring your heart rate, and the second is by evaluating your perceived exertion level (this is simpler than it sounds!).

PERCEIVED EXERTION LEVEL

The second and simpler way to gauge your exercise intensity is to evaluate your perceived exertion level. While exercising if you are too winded to maintain a conversation without gasping, you are working out too hard. A good rule of thumb is to work to the point of exhilaration, not exhaustion. If you cannot catch your breath, it's time to slow down. Always be aware of other warning signs of overexertion.

DEVELOPING A FITNESS PROGRAM

TIPS

STRETCH FIRST

Before using your product, it is best to take a few minutes doing a few gentle stretching exercises. Stretching prior to exercise will improve flexibility and reduce chances of exercise related injury. Ease into each of these stretches with a slow gentle motion. Do not stretch to the point of pain. Make sure not to bounce while doing these stretches.

WALL PUSH

Stand near a wall with the toes of one foot about 18" from the wall, and the other foot about 12" behind the other foot. Lean forward, pushing against the wall with your palms. Keep your heels flat and hold this position for a count of 15 seconds. Make sure that you do not bounce while stretching. Alternate positions of your feet and repeat for a total of 8 repetitions.

STANDING QUADRICEPS STRETCH

Using a wall to provide balance, grasp your left ankle with your left hand and hold your foot against the back of your thigh for a count of 15 seconds. Repeat with your right ankle and hand, and continue alternating for a total of 8 repetitions.

SEATED TOE TOUCH

Sit on the floor with your legs together and straight out in front of you. Do not lock your knees. Extend your fingers towards your toes and hold for a count of 15 seconds. Make sure that you do not bounce while stretching. Sit upright again. Repeat for a total of 8 repetitions.

THE IMPORTANCE OF WARM UP AND COOL DOWN

WARM UP

The first 2 to 5 minutes of a workout should be devoted to warming up. The warm-up will limber your muscles and prepare them for more strenuous exercise. Make sure that you warm-up on your Horizon Fitness product at a slow pace.

COOL DOWN

Never stop exercising suddenly! A cool-down period allows your heart to readjust to the decreased demand. Make sure that your cool down period consists of a very slow pace to allow your heart rate to lower. After the cool-down, repeat the stretching exercises listed above to loosen and relax your muscles.

ACHIEVING YOUR FITNESS GOALS

An important step in developing a long term fitness program is to determine your goals. Is your primary goal for exercising on your treadmill to lose weight? Improve muscle? Burn Stress? Prepare for the spring racing schedule? Knowing what your goals are will help you develop a more successful exercise program. Below are some common exercise goals:

- Weight Loss
- Improve Body Shape and Tone
- Increased Energy Level
- Improved Sports Performance
- Improved Cardiovascular Endurance
- Weight Maintenance
- Strengthen Leg Muscles
- Improved Sleep Patterns
- Stress Reduction

If possible try to define your personal goals in precise, measurable terms, and then put your goals in writing. The more specific you can be, the easier it will be to track your progress. If your goals are long term, divide them up into monthly and weekly segments. Longer term goals can lose some of the immediate motivation benefits. Short term goals are easier to achieve. Your treadmill console provides you with several readouts that can be used to record your progress. You can track Distance, Calories or Time. Time is the most important and useful of test functions.

KEEPING AN EXERCISE DAIRY

Photocopy the weekly and monthly log sheets on the following pages to make your personal exercise log book. As time goes by you'll be able to look back with pride at the work you've done. As your fitness improves, you can look back and see how far you've come.

WEEKLY LOG SHEET

WEEK # _____		WEEKLY GOAL: _____			
DAY	DATE	DISTANCE	CALORIES	TIME	COMMENTS
SUN					
MON					
TUES					
WED					
THUR					
FRI					
SAT					
WEEKLY TOTALS					

WEEK # _____		WEEKLY GOAL: _____			
DAY	DATE	DISTANCE	CALORIES	TIME	COMMENTS
SUN					
MON					
TUES					
WED					
THUR					
FRI					
SAT					
WEEKLY TOTALS					

MONTHLY LOG SHEET

MONTH _____		MONTHLY GOAL: _____	
WEEK #	DISTANCE	CALORIES	TIME
MONTHLY TOTALS			

MONTH _____		MONTHLY GOAL: _____	
WEEK #	DISTANCE	CALORIES	TIME
MONTHLY TOTALS			

LIMITED HOME USE WARRANTY

T20

FRAME • LIFETIME

Horizon Fitness warrants the frame against defects in workmanship and materials for the lifetime of the original owner.

DRIVE MOTOR • 25 YEARS

Horizon Fitness warrants the drive motor against defects in workmanship and materials for a period of ten years from the date of purchase, so long as the device remains in the possession of the original owner.

ELEVATION MOTOR • 25 YEARS

Horizon Fitness warrants the elevation motor against defects in workmanship and materials for a period of ten years from the date of purchase, so long as the device remains in the possession of the original owner.

ELECTRONICS & PARTS • 1 YEAR

Horizon Fitness warrants the electronic components, finish and all original parts for a period of one year from the date of original purchase, so long as the device remains in the possession of the original owner.

LABOR • 90 DAYS

Horizon Fitness shall cover the labor cost for the repair of the device for a period of ninety days from the date of the original purchase, so long as the device remains in the possession of the original owner.

EXCLUSIONS AND LIMITATIONS

This warranty applies only to the original owner and is not transferable. This warranty is expressly limited to the repair or replacement of a defective frame, motor, electronic component, or defective part and is the sole remedy of the warranty. The warranty does not cover normal wear and tear, improper assembly or maintenance, or installation of parts or accessories not originally intended or compatible with the Treadmill as sold. The warranty does not apply to damage or failure due to accident, abuse, corrosion, discoloration of paint or plastic, or neglect. Horizon Fitness shall not be responsible for incidental or consequential damages. All returns must be pre-authorized by Horizon Fitness. Horizon Fitness' obligation under this warranty is limited to replacing or repairing, at Horizon Fitness' option, the product at one of its authorized service centers. An Horizon Fitness authorized service center must receive all products for which a warranty claim is made. These products must be received with all freight and other transportation charges prepaid, accompanied by sufficient proof of purchase. Parts and electronic components reconditioned to As New Condition by Horizon Fitness or its vendors may sometimes be supplied as warranty replacement parts and constitute fulfillment of warranty terms. This warranty gives you specific legal rights, and your rights may vary from state to state. This warranty is applicable to sales made only by Horizon Fitness, its affiliates, subsidiaries and authorized distributors of Horizon Fitness products within the U.S. and Canada.

LIMITED HOME USE WARRANTY

T30 & T40

FRAME • LIFETIME

Horizon Fitness warrants the frame against defects in workmanship and materials for the lifetime of the original owner.

DRIVE MOTOR • 10 YEARS

Horizon Fitness warrants the drive motor against defects in workmanship and materials for a period of ten years from the date of purchase, so long as the device remains in the possession of the original owner.

ELEVATION MOTOR • 10 YEARS

Horizon Fitness warrants the elevation motor against defects in workmanship and materials for a period of ten years from the date of purchase, so long as the device remains in the possession of the original owner.

ELECTRONICS & PARTS • 1 YEAR

Horizon Fitness warrants the electronic components, finish and all original parts for a period of one year from the date of original purchase, so long as the device remains in the possession of the original owner.

LABOR • 1 YEAR

Horizon Fitness shall cover the labor cost for the repair of the device for a period of one year from the date of the original purchase, so long as the device remains in the possession of the original owner.

EXCLUSIONS AND LIMITATIONS

This warranty applies only to the original owner and is not transferable. This warranty is expressly limited to the repair or replacement of a defective frame, motor, electronic component, or defective part and is the sole remedy of the warranty. The warranty does not cover normal wear and tear, improper assembly or maintenance, or installation of parts or accessories not originally intended or compatible with the Treadmill as sold. The warranty does not apply to damage or failure due to accident, abuse, corrosion, discoloration of paint or plastic, or neglect. Horizon Fitness shall not be responsible for incidental or consequential damages. All returns must be pre-authorized by Horizon Fitness. Horizon Fitness' obligation under this warranty is limited to replacing or repairing, at Horizon Fitness' option, the product at one of its authorized service centers. An Horizon Fitness authorized service center must receive all products for which a warranty claim is made. These products must be received with all freight and other transportation charges prepaid, accompanied by sufficient proof of purchase. Parts and electronic components reconditioned to As New Condition by Horizon Fitness or its vendors may sometimes be supplied as warranty replacement parts and constitute fulfillment of warranty terms. This warranty gives you specific legal rights, and your rights may vary from state to state. This warranty is applicable to sales made only by Horizon Fitness, its affiliates, subsidiaries and authorized distributors of Horizon Fitness products within the U.S. and Canada.



Designed for life.™

HORIZON FITNESS
800 BURTON BOULEVARD
DEFOREST, WISCONSIN 53532
phone 1.888.993.3199 fax 1.608.842.1660
www.horizonfitness.com