

GT-B2710 user manual



Using this manual

Thank you for purchasing this Samsung mobile phone. This phone will provide you with high quality mobile communication and entertainment based on Samsung's exceptional technology and high standards.

This user manual has been specially designed to guide you through the functions and features of your phone.

Read me first

- Please read all safety precautions and this manual carefully before using your phone to ensure safe and proper use.
- The descriptions in this manual are based on the default settings of your phone.
- Images and screenshots used in this user manual may differ in appearance from the actual product.
- Content in this user manual may differ from the product, or from software provided by service providers or carriers, and is subject to change without prior notice. Refer to www.samsungmobile.com for the latest version of the user manual.
- Available features and additional services may vary by phone, software, or service provider.
- Applications and their functions may vary by country, region, or hardware specifications. Samsung is not liable for performance issues caused by third-party applications.
- You may upgrade your mobile phone's software by accessing www.samsungmobile.com.
- Sound sources, wallpapers, and images provided in this phone are licenced for limited use between Samsung and their respective owners. Extracting and using these materials for commercial or other purposes is an infringement of copyright laws. Samsung is not liable for such copyright infringement by the user.
- Please keep this manual for future reference.

Instructional icons

Before you start, familiarise yourself with the icons you will see in this manual:



Warning—situations that could cause injury to yourself or others



Caution—situations that could cause damage to your phone or other equipment



Note—notes, usage tips, or additional information



Refer to—pages with related information; for example: ► p.12 (represents “see page 12”)



Followed by—the order of options or menus you must select to perform a step; for example: In Menu mode, select **Messages** → **Create message** (represents **Messages**, followed by **Create message**)



Square brackets—phone keys; for example: [⏻] (represents the Power/End key)



Angled brackets—softkeys that control different functions at each screen; for example: <**OK**> (represents the **OK** softkey)

Copyright

Copyright © 2010 Samsung Electronics

This user manual is protected under international copyright laws.

No part of this user manual may be reproduced, distributed, translated, or transmitted in any form or by any means, electronic or mechanical, including photocopying, recording, or storing in any information storage and retrieval system, without the prior written permission of Samsung Electronics.

Trademarks

- SAMSUNG and the SAMSUNG logo are registered trademarks of Samsung Electronics.
- Bluetooth® is a registered trademark of the Bluetooth SIG, Inc. worldwide.
- Oracle and Java are registered trademarks of Oracle and/or its affiliates. Other names may be trademarks of their respective owners.
- Windows Media Player® is a registered trademark of Microsoft Corporation.
- All other trademarks and copyrights are the property of their respective owners.

CE0168

Contents

Assembling 8

Unpack 8

Install the SIM or USIM card and battery 8

Charge the battery 10

Insert a memory card (optional) 12

Getting started 15

Turn your phone on and off 15

Get to know your phone 15

Lock or unlock the keys 20

Access menus 20

Customise your phone 20

Enter text 25

Communication 26

Calling 26

Logs 29

Messages 31

Email 35

Instant messenger 36

Entertainment 37

Camera 37

Media browser 39

Music	40
FM radio	42
Games and more	43

Synchronise	53
Communities	53
Community websites	54

Personal information 45

Contacts	45
Calendar	47
Task	47
Memo	48
Voice recorder	48

Connectivity 55

Bluetooth	55
GPS	58
PC connections	58

Web 50

Internet	50
Downloads	52
Google	52

Tools 61

Alarms	61
Calculator	61
Compass	62
Convertor	62
Image editor	62

My files	64	Applications	69
Pedometer	65	Security	70
Search	65	PC connections	70
Stopwatch	66	Network	70
Timer	66	Profile wizard	71
World clock	66	Memory	71
Settings	68	Reset	71
Access the Settings menu	68	About phone	71
Sound profiles	68	Troubleshooting	72
Display	68	Safety precautions	75
Time and date	68	Index	85
Phone	69		
Call	69		

Assembling

Unpack

Check your product box for the following items:

- Mobile phone
- Battery
- Travel adapter (charger)
- User manual



Use only Samsung-approved software. Pirated or illegal software may cause damage or malfunctions that are not covered by your manufacturer's warranty.



- The items supplied with your phone may vary depending on the software and accessories available in your region or offered by your service provider.
- You can obtain additional accessories from your local Samsung dealer.
- The supplied accessories perform best for your phone.
- Accessories other than the supplied ones may not be compatible with your phone.

Install the SIM or USIM card and battery

When you subscribe to a cellular service, you will receive a Subscriber Identity Module (SIM) card, with subscription details, such as your personal identification number (PIN) and optional services. To use UMTS services, you can purchase a Universal Subscriber Identity Module (USIM) card.

To install the SIM or USIM card and battery,

- 1 If the phone is on, press and hold [⏻] to turn it off.
- 2 Turn the screw anti-clockwise to unlock the back cover, and then remove the cover.

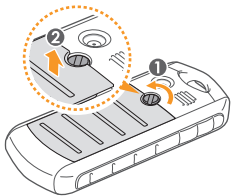

-  Do not use your fingernails to unscrew. Use a coin or screw driver, instead.

- 3 Insert the SIM or USIM card.

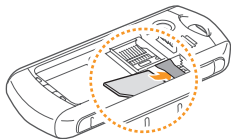

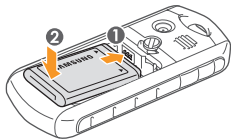

-  • Place the SIM or USIM card into the phone with the gold-coloured contacts facing down.
- If you do not insert a SIM or USIM card, you can only use your phone's non-network services and some menus.

- 4 Insert the battery.

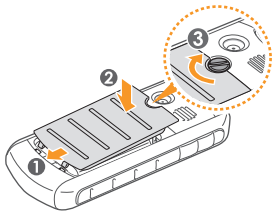

- 5 Replace the back cover and turn the screw clockwise to lock the cover.





-  Ensure the cover is completely closed and the screw is tightly fastened to avoid water damage.

Charge the battery

Before using the phone for the first time, you must charge the battery.

You can charge the phone with the provided travel adapter or by connecting the phone to a PC with a PC data cable.

-  Use only Samsung-approved chargers and cables. Unauthorised chargers or cables can cause batteries to explode or damage your phone.
-  When your battery is low, the phone will emit a warning tone and display a low battery message. The battery icon  will also be empty and blinking. If the battery level becomes too low, the phone will automatically power off. Recharge your battery to continue using your phone.

Charge with the travel adapter

- 1 Open the cover to the multifunction jack on the side of the phone.
- 2 Plug the small end of the travel adapter into the multifunction jack.

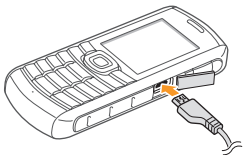

! Improperly connecting the travel adapter can cause serious damage to the phone. Any damages due to misuse are not covered by the warranty.

- 3 Plug the large end of the travel adapter into a power outlet.



- You can use the phone while it is charging, but it may take longer to fully charge the battery.
 - While charging, the phone may heat up. This is normal and should not affect your phone's lifespan or performance.
 - If your phone is not working properly, bring your phone and the charger to a Samsung Service Centre.
- 4 When the battery is fully charged (the battery icon is no longer moving), unplug the travel adapter from the phone and then from the power outlet.



Do not remove the battery before removing the travel adapter. Doing this may cause damage to the phone.



› Charge with the PC data cable

Before charging, ensure that your PC is turned on.

- 1 Open the cover to the multifunction jack on the side of the phone.
 - 2 Plug one end (micro-USB) of the PC data cable into the multifunction jack.
 - 3 Connect the other end of the PC data cable into a USB port on a PC.
-  Depending on the type of PC data cable you are using, it may take some time before charging begins.
- 4 When the battery is fully charged (the battery icon is no longer moving), unplug the PC data cable from the phone and then from the PC.

Insert a memory card (optional)

To store additional multimedia files, you must insert a memory card. Your phone accepts microSD™ or microSDHC™ memory cards with maximum capacities of 16 GB (depending on memory card manufacturer and type).

-  Samsung uses approved industry standards for memory cards, but some brands may not be fully compatible with your phone. Using an incompatible memory card may damage your phone or the memory card and can corrupt data stored on the card.
-  • Your phone supports only the FAT file structure for memory cards. If you insert a card formatted with a different file structure, your phone will ask you to reformat the memory card.
- Frequent writing and erasing of data will shorten the lifespan of memory cards.

- 1 Turn the screw anti-clockwise to unlock the cover, and then remove the cover.
- 2 Insert a memory card with the gold-coloured contacts facing down.



- 3 Gently push the memory card down, and then slide it backward until it locks in place.



- 4 Insert the battery.
- 5 Replace the back cover and turn the screw clockwise to lock the cover.

➤ Remove the memory card

- 1 Ensure that the memory card is not in the middle of an operation.
- 2 Turn the screw anti-clockwise to unlock the cover, and then remove the cover.
- 3 Gently push the memory card into the slot until it disengages from the phone, and then slide it out of the memory card slot.

 Do not remove a memory card while the phone is transferring or accessing information, as this could result in loss of data or damage to the memory card or phone.

› Format the memory card

Formatting your memory card on a PC may cause incompatibilities with your phone. Format the memory card only on the phone.

In Menu mode, select **Settings** → **Memory** → **Memory card** → **Format memory card** → <Yes>.



Before formatting the memory card, remember to make backup copies of all important data stored in your phone. The manufacturer's warranty does not cover loss of data resulting user actions.

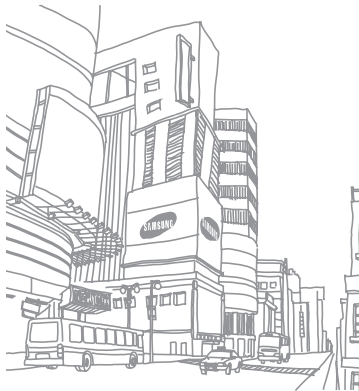

Getting started

Turn your phone on and off

To turn on your phone,

- 1 Press and hold [Power].
- 2 Enter your PIN and press <OK> (if necessary).
- 3 When the setup wizard opens, customise your phone as desired by following the screen.

To turn off your phone, repeat step 1 above.



- Follow all posted warnings and directions from official personnel when in areas where the use of wireless devices is restricted, such as aeroplanes and hospitals.
- To use your phone's non-network services only, switch to the offline profile. ► p. 21

Get to know your phone

› Phone layout

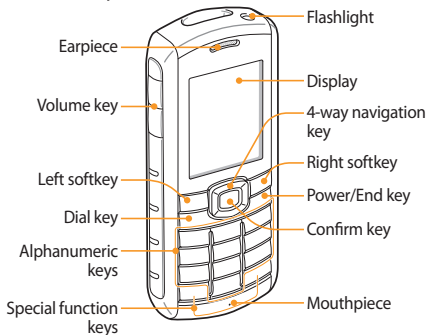

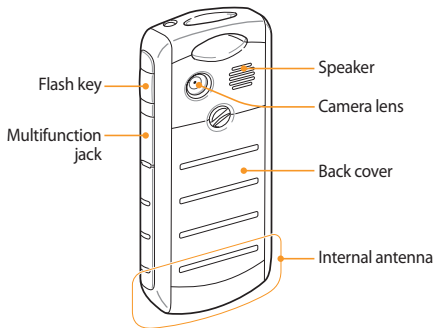

› Maintain your water and dust resistant feature



Your phone offers limited protection against accidental exposure to water in some conditions, but you should never intentionally immerse the phone in water.





- Do not expose your phone to high water pressures or any other liquids, such as salt water, ionized water or dirty water.
- If the phone gets wet, dry it thoroughly with a clean soft cloth.
- Ensure that all covers are properly aligned and tightly closed.





- Always keep the back cover and multifunction jack cover and the area around them clean and be careful to avoid damaging them. If the back cover or multifunction jack cover become contaminated, they may not provide protection from dust and water.
- Any service performed on the phone may reduce the water and dust protection. Avoid exposing the phone to dust and water if any service has been performed on it.
- Exposing the phone to extreme temperatures may reduce the water and dust protection. Use your phone at -20 °C to 50 °C.

› Keys

Key	Function
 Volume	Adjust the phone's volume.
 Softkey	Perform actions indicated at the bottom of the display.









Key	Function
 Dial	Make or answer a call; In Idle mode, retrieve recently dialed, missed, or received numbers.
 4-way navigation	Scroll through menu options; In Idle mode, access user-defined menus (left/right/up/down); In Idle mode, press and hold the Navigation key down to make a fake call.
 Confirm	In Menu mode, select the highlighted menu option or confirm an input.
 Power/ End	Turn the phone on or off (press and hold); End a call; In Menu mode, return to Idle mode.











Key		Function
	Alpha-numeric	Enter numbers, letters, and special characters.
	Special function	Enter special characters or perform special functions; In Idle mode, press and hold [*] to lock or unlock the keys; Press and hold [#] for the silent profile.
	Flash	Turn the flash on (press and hold) or turn the flash off.









› Indicator icons



Icons shown on the display may vary depending on your region or service provider.

Icon	Definition
	Signal strength
	GPRS network connected
	EDGE network connected
	UMTS network connected
	Voice call in progress
	Video call in progress
	SOS message feature activated
	Browsing the web
	Connected to secured web page

Icon	Definition
	Roaming (outside of normal service area)
	Call diverting activated
	Connected with PC
	Bluetooth hands-free car kit or headset connected
	Bluetooth activated
	Alarm activated
	Memory card inserted
	New text message (SMS)
	New multimedia message (MMS)
	New email message
	New voice mail message

Icon	Definition
	Normal profile activated
	Silent profile activated
	Music playback in progress
	Music playback paused
	FM radio on
	FM radio suspended
	Web pages containing RSS feeds
	Battery power level
	Current time

Lock or unlock the keys

You can lock the keys to prevent any unwanted phone operations. To lock the keys, press and hold [*****]. To unlock these keys, press and hold [*****].

When the auto keypad lock is on, the keys will be locked automatically after the display turns off.

Access menus

To access your phone's menus,

- 1 In Idle mode, press <**Menu**> or the Confirm key to access Menu mode.
- 2 Use the Navigation key to scroll to a menu or option.
- 3 Press <**Select**>, <**OK**>, or the Confirm key to confirm the highlighted option.
- 4 Press <**Back**> to move up one level; Press [**⏏**] to close the menu or application and return to Idle mode.

Customise your phone

Get more from your phone by customising it to match your preferences.

› Change the language of the display

- 1 In Menu mode, select **Settings** → **Phone** → **Language**.
- 2 Select a language you want.

› Set the current time and date

- 1 In Menu mode, select **Settings** → **Time and date**.
- 2 Set the time and date format, and enter the current time and date.

› Adjust the volume of the key tones

In Idle mode, press [**▲/▼**].

› Switch to the silent profile

In Idle mode, press and hold [#] to mute or unmute your phone.

› Set up a sound profile

You can change your phone's sounds by customising the current sound profile or switching to another sound profile. To set up a profile,

- 1 In Menu mode, select **Settings** → **Sound profiles**.
 - 2 Scroll to the profile you are using.
 - 3 Press <**Edit**>.
 - 4 Customise the sound options for incoming calls, incoming messages, and other phone sounds.
-  Available sound options vary depending on the selected profile.
- 5 Press <**Back**>.

To switch to another profile, select it from the list.

› Select a wallpaper for the idle screen

- 1 In Menu mode, select **Settings** → **Display** → **Wallpaper**.
- 2 Select a memory location.
- 3 Select an image.

› Adjust the brightness of the display

- 1 In Menu mode, select **Settings** → **Display** → **Brightness**.
 - 2 Scroll left or right to adjust the level of brightness.
 - 3 Press <**Save**>.
-  The brightness level of the display will affect how quickly the phone consumes battery power.

› Set menu shortcuts

- 1 In Menu mode, select **Settings** → **Phone** → **Shortcuts**.
- 2 Select a key to use as a shortcut.
- 3 Select a menu to assign to the shortcut key.

 When you are using the smart home screen, the Navigation key does not work as shortcuts.

› Use the smart home screen

The smart home screen allows you to access your favourite applications and contacts and view upcoming events or tasks. You can customise the smart home screen to fit your preferences and needs.

To customise the smart home screen,

- 1 In Menu mode, select **Settings** → **Display** → **Smart home**.
- 2 Press <**Edit**>.

- 3 Select the items to display on the smart home screen.
 Available items may vary depending on your region or service provider.

- 4 Press <**Save**>, or press <**Options**> → **Save**.
If you select **Dual clock**, you can set the second clock.

- 5 Press the Confirm key.

 You can change the idle screen to another style. In Menu mode, select **Settings** → **Display** → **Smart home** and scroll left or right to a style you want.

To access the smart home items, press the Navigation key to scroll through the items on the smart home screen and press the Confirm key to select an item.

To customise the shortcuts toolbar,

- 1 In Menu mode, select **Settings** → **Display** → **Smart home**.
- 2 Press <**Edit**>.

- 3 Scroll to **Shortcuts toolbar** and press **<Options>** → **Edit shortcuts**.
- 4 Select a menu to change or an empty location.
- 5 Select the menus you want.
Press **<Options>** → **Open** to select submenus (if necessary).
- 6 Press **<Save>**, or press **<Options>** → **Save**.

› Lock your phone

You can lock your phone by activating the phone password.

- 1 In Menu mode, select **Settings** → **Security** → **Phone lock**.
- 2 Enter a new 4- to 8-digit password and press **<OK>**.

- 3 Enter the new password again and press **<OK>**.
-  The first time you access a menu that requires a password, you will be prompted to create and confirm a password.

Once the phone lock is enabled, you must enter the password each time you turn on the phone.

-  • If you forget your password, bring your phone to a Samsung Service Centre to unlock it.
- Samsung is not responsible for any loss of passwords or private information or other damages caused by illegal software.

› Lock your SIM or USIM card

You can lock your phone by activating the PIN supplied with your SIM or USIM card.

- 1 In Menu mode, select **Settings** → **Security** → **PIN lock**.

- 2 Enter the PIN of your SIM or USIM card and press **<OK>**.

Once the PIN lock is enabled, you must enter the PIN each time you turn on the phone.



- If you enter an incorrect PIN too many times, your SIM or USIM card will be blocked. You must enter a PIN unlock key (PUK) to unblock the SIM or USIM card.
- If you block your SIM or USIM card by entering an incorrect PUK, bring the card to your service provider to unblock it.

➤ **Activate the mobile tracker**

When someone inserts a new SIM or USIM card in your phone, the mobile tracker feature will automatically send the contact number to specified recipients to help you locate and recover your phone.

- 1 In Menu mode, select **Settings** → **Security** → **Mobile tracker**.
- 2 Enter your password and press **<OK>**.
- 3 Press the Confirm key to select **On**.
- 4 Select **Recipients** to open the recipient list.
- 5 Press **<Options>** → **Contacts** to open your contact list.
- 6 Select contacts.
- 7 When you are finished selecting contacts, press **<Add>**.
- 8 Select a number (if necessary).
- 9 Press the Confirm key to save the recipients.
- 10 Scroll down and enter the sender's name.
- 11 Press the Confirm key → **<Accept>**.

Enter text

You can enter text by pressing keys on the keypad.

Change the text input method



Available text input modes may vary depending on your region.

- Press and hold [*] and select **Writing language** to select a writing language.
- Press and hold [*] and select **Input method (Abc)** to select an input mode.
- Press [#] to change case or switch between English and Number input modes.
- Press [*] to switch to Symbol mode.
- Press and hold [#] to switch between ABC and T9 modes.

Enter text using input methods

Mode	Function
ABC	Press an appropriate alphanumeric key until the character you want appears on the display.
T9	<ol style="list-style-type: none">1. Press appropriate alphanumeric keys to enter an entire word.2. When the word displays correctly, press [0] to insert a space. If the correct word does not display, press the Navigation key up or down until the word you want displays.
Number	Press an appropriate alphanumeric key to enter a number.
Symbol	<ol style="list-style-type: none">1. Press the Navigation key up or down to scroll to a symbol set you want.2. Press an appropriate alphanumeric key to enter a symbol.

Communication

Calling

Learn to use calling functions, such as making and answering calls using options available during a call, or customising and using call-related features.

› Make and answer a call

Make a call

- 1 In Idle mode, enter an area code and a phone number.
- 2 Press [**Call**] to dial the number. For a video call, press <**Options**> → **Video call**.

3 To end the call, press [**End call**].



- Use the phonebook to save numbers you dial frequently. ► p. 45
- To quickly access the call log to redial the numbers you dialled recently, press [**Recent calls**].

Answer a call

1 When a call comes in, press [**Answer**].



When the phone is ringing, press [**Volume up/down**] to adjust the volume, or press and hold [**Volume down**] to mute the ringtone.

- 2 For a video call, press <**Camera on**> to allow the caller to see you.
- 3 To end the call, press [**End call**].

Reject a call

When a call comes in, press []. The caller will hear a busy tone.





- You can set up a list of numbers to reject incoming calls automatically. ► p. 28
- You can send a message when you reject incoming calls. In Menu mode, select **Settings** → **Call** → **All calls** → **Reject call with message**.

Call an international number

- 1 In Idle mode, press and hold [0] to insert the + character.
- 2 Enter the complete number you want to dial (country code, area code and phone number), and then press [] to dial the number.

Use options during a voice call

You can use the following options while a voice call is in progress:

- To adjust the voice volume, press [].
 - To activate the speakerphone feature, press the Confirm key.
-  In noisy environments, you may have difficulty hearing some calls while using the speakerphone feature. For better audio performance, use the normal phone mode.
- To place a call on hold, press <**Hold**>. To retrieve a held call, press <**Retrieve**>.
 - To dial a second call, place the first call on hold and then dial a new number.
 - To answer a second call, press [] when a call waiting tone sounds. The first call is automatically placed on hold. You must subscribe to the call waiting service to use this feature.
 - To switch between the two calls, press <**Swap**>.

› View and dial missed calls

Your phone will display calls you have missed on the display.

To dial the number of a missed call,

- 1 Press the Confirm key to open the call log.
- 2 Scroll to the missed call you want to dial.
- 3 Press [**↩**] to dial.

› Use additional features

You can use various other call-related features, such as auto rejection, fake calls, or Fixed Dialling Number (FDN) mode.

Set auto rejection

Use auto rejection to reject calls from certain numbers automatically. To activate auto rejection and set up the reject list,

- 1 In Menu mode, select **Settings** → **Call** → **All calls** → **Auto reject**.
- 2 Press <**Change**> to activate auto rejection.
- 3 Select **Reject list**.
- 4 Press <**Create**>, or press <**Options**> → **Create**.
- 5 Enter a number to reject and press the Confirm key.
- 6 To add more numbers, repeat steps 4-5.

Make a fake call

You can simulate incoming calls when you want to get out of meetings or unwanted conversations.

To activate the fake call feature, in Menu mode, select **Settings** → **Call** → **Fake call** → **Fake call hot key** → **On**.

To make a fake call, press the Navigation key down 4 times in Idle mode or with the keys locked. A fake call comes in after a specified length of time.



You can change the delay time before fake calls. In Menu mode, select **Settings** → **Call** → **Fake call** → **Fake call timer**.

You can make fake calls appear more realistic by playing back a recorded voice. To record a voice,

- 1 In Menu mode, select **Settings** → **Call** → **Fake call** → **Fake call voice**.
- 2 Scroll to **Fake call voice**.
- 3 Press <**Edit**>.
- 4 Press the Confirm key to start recording.
- 5 Speak into the microphone.
- 6 When you are finished, press <**Stop**>.

Use Fixed Dialling Number (FDN) mode

In FDN mode, your phone will restrict outgoing calls, except for the numbers stored in the FDN list. You must first set up your FDN list in the phonebook to use FDN mode.

To activate FDN mode,

- 1 In Menu mode, select **Settings** → **Security** → **Fixed dialling mode**.
- 2 Enter the PIN2 supplied with your SIM or USIM card and press <**OK**>.

Logs

Learn to view and manage logs of calls you have dialled, received, or missed and messages you have sent.

› View call and message logs

You can view logs of your calls and messages filtered by their types.

1 In Menu mode, select **Comms.** → **Logs.**

2 Scroll left or right to select a log type.

3 Select a log to view its details.

 From the detail view, you can dial the number, send a message to the number or add the number to the phonebook or reject list.

› View the log manager

From the log manager, you can check the amount of data or number of messages sent or received and the cost and duration of your calls.

1 In Menu mode, select **Comms.** → **Logs.**

2 Press <**Log manager**>.

If there is a log saved, press <**Options**> → **Log manager.**

3 Select an option you want.

Option	Function
Call duration	View time data for your calls, such as the duration of the last call and the total duration of all calls.
Call costs	View cost records for your calls, such as the cost of the last call and the total cost of all calls. You can also set the currency and price per unit, or cost limit to restrict calls according to your calling plan; The cost counter may be unavailable depending on your SIM or USIM card.

Option	Function
Message counter	View the number of messages you have sent or received.
Data counter	View the amount of data you have sent or received.



You can reset the records in the log manager. Press **<Reset>** or the Confirm key depending on the screen you are viewing.

Messages

Learn to create and send text (SMS) or multimedia (MMS) messages and view or manage messages you have sent or received.



You may incur additional charges for sending or receiving messages while outside your home service area. For details, contact your service provider.

› Send a text message

- 1 In Menu mode, select **Messages** → **Create message**.
- 2 Press the Confirm key and select **Contacts**.
You can enter a number manually or select one from the logs or contact groups by scrolling left or right.
- 3 Scroll to a contact and press the Confirm key.
- 4 Scroll down and enter your message text.
- 5 Press the Confirm key to send the message.

› Set up an MMS profile

To send and receive multimedia messages, you must activate a connection profile for connecting to the MMS server. In addition to profiles that are preset by your service provider, you can add your own connection profile.

- 1 In Menu mode, select **Messages** → **Settings** → **Multimedia messages** → **Multimedia message profiles**.

2 Select the connection profile.

➤ Send a multimedia message

1 In Menu mode, select **Messages** → **Create message**.

2 Press the Confirm key and select **Contacts**.
You can enter a number or an email address manually or select one from the logs or contact groups by scrolling left or right.

3 Scroll to a contact and press the Confirm key.
When you enter an email address, the phone will ask if you want to send a multimedia message. Press <**Yes**> to confirm.

4 Scroll down and enter your message text.

5 Press <**Options**> → **Add multimedia** and attach a file.
You can select a file from the file list or capture a photo, video, or sound clip.

6 Press the Confirm key to send the message.

➤ View a message

Messages you have received, sent or saved are sorted automatically into the following message folders.

- **Inbox:** Received text or multimedia messages
- **Sentbox:** Sent messages
- **Outbox:** Messages that are currently sending or waiting to be sent
- **Drafts:** Messages that you have saved for future use
- **Broadcast messages:** Cell broadcast messages from your network
- **Spambox:** Spam messages

View a text or multimedia message

1 In Menu mode, select **Messages** and select a message folder (inbox or sentbox).

2 Select a text or multimedia message.

› Listen to voice mail messages

If you have set missed calls to be diverted to the voice mail server, callers may leave voice messages when you do not answer incoming calls. To access your voice mail box and listen to voice mail messages,

- 1 In Idle mode, press and hold [1].
 - 2 Follow the instructions from the voice mail server.
-  You must save the voice mail server number before accessing the server. Your service provider can give you the number.

› Use message templates

Learn to create and use text and multimedia templates to quickly and easily create new messages.

Create a text template

- 1 In Menu mode, select **Messages** → **My folders** → **Templates**.

- 2 Press <**Create**> to open a new template window.
- 3 Enter your text and press the Confirm key.

You can now insert a text template in the text field while creating a text or multimedia message by using the inserting option.

Create a multimedia template

- 1 In Menu mode, select **Messages** → **My folders** → **MMS cards**.
- 2 Press <**Create**> to open a new template window.
- 3 Create a multimedia message, with a subject and desired attachments, to use as your template. ► p. 32
- 4 Press the Confirm key.

To use a multimedia template to create a new multimedia message, from the template list, scroll to a template to use and press <**Options**> → **Send**. Your template will open as a new multimedia message.

› Create a folder to manage messages

Learn to create folders to manage your messages according to your preferences and needs.

- 1 In Menu mode, select **Messages** → **My folders**.
- 2 Press <**Options**> → **Create folder**.
- 3 Enter a new folder name and press the Confirm key.

You can now move your important messages from the inbox or sentbox to a custom folder for easier management or preventing them from accidental deletion.

› Send an SOS message

In case of an emergency, you can ask for help by sending an SOS message to specified recipients.



This feature may be unavailable depending on your region or service provider.

- 1 In Menu mode, select **Messages** → **Settings** → **SOS messages** → **Sending options**.
- 2 Press <**Change**> to turn on the SOS messaging feature.
- 3 Select **Recipients** to open the recipient list.
- 4 Enter a recipient number and press the Confirm key. Skip to step 7.
To select a number saved in your contact list, press <**Options**> → **Contacts** to open the contact list and then continue with the next step.
- 5 Select contacts and press <**Add**>.
- 6 Select a phone number (if necessary).
- 7 When you are finished setting the recipients, press the Confirm key.
- 8 Select **Repeat** and select the number of times to repeat the SOS message.
- 9 Press <**Back**> → **Yes**.

To send an SOS message, the keys must be locked. Press [▲/▼] 4 times.



Once you send an SOS message, all phone functions will be suspended until you press [Ⓜ].

Email

Learn to create and send email messages, and view or manage messages you have sent or received.

› Set up an email account

In addition to the email account predefined by your service provider, you can add your personal email accounts.

- 1 In Menu mode, select **Email** → **<Yes>**.
- 2 Select an email service or other email accounts.
- 3 Customise the settings for the account.
- 4 When you are finished creating an account, select an account to use.

› Send an email message

- 1 In Menu mode, select **Email**.
- 2 Press **<Options>** → **Create email**.
- 3 Press the Confirm key and select **Contacts**.
You can enter an email address manually or select one from the logs or contact groups by scrolling left or right.
- 4 Scroll to a contact and press the Confirm key.
- 5 Scroll down and enter a subject.
- 6 Scroll down and enter your email text.
- 7 Press **<Options>** → **Attach items** and attach a file.
You can select a file from the file list or capture a photo, or record a video or sound clip.
- 8 Press the Confirm key to send the message.

› View an email message

- 1 In Menu mode, select **Email**.
- 2 Press the Confirm key.
- 3 Select an email or a header.
- 4 If you selected a header, press <**Retrieve**> to view the body of the email.

Instant messenger

Learn to chat with friends and family from the universal instant messenger.



This feature may be unavailable depending on your region or service provider.

- 1 In Menu mode, select **Comms.** → **Instant messenger**.
- 2 Press the Confirm key from the intro window.



- The first time you access the messenger, you will be prompted to confirm.
 - To change the language for the messenger, access the messenger and press <**Menu**> → **Settings** → **Language**.
- 3 Enter your user ID and password, and press <**Sign In**>.
 - 4 Chat with your family or friends instantly.

Entertainment

Camera

Learn how to capture and view photos and videos. You can capture photos at resolutions up to 1600 x 1200 pixels (2 megapixels) and videos at resolutions up to 160 x 128 pixels.

› Capture a photo

1 In Menu mode, select **Camera** to turn on the camera.

2 Rotate the phone anti-clockwise to landscape view.



- The camera interface appears only in the landscape orientation.
- The camera automatically turns off when you do not use it for a specified period.
- The memory capacity may differ depending on the shooting scene or shooting conditions.

3 Aim the lens at the subject and make any necessary adjustments.

4 Press [**▲**/**▼**] to zoom in or out.

5 Press the Confirm key to take a photo.
The photo is saved automatically.

After capturing photos, press **<View>** to view the captured photos.

› Capture a beauty photo

You can hide facial imperfections using Beauty mode.

1 In Menu mode, select **Camera** to turn on the camera.

2 Rotate the phone anti-clockwise to landscape view.

3 Press **<Options>** → **Shooting mode** → **Beauty** → **<Back>**.

4 Make any necessary adjustments.

5 Press the Confirm key to take a photo.

› Capture a photo in Smile shot mode

Your camera can recognise people's faces and help you capture photos of their smiling faces.

- 1 In Menu mode, select **Camera** to turn on the camera.
- 2 Rotate the phone anti-clockwise to landscape view.
- 3 Press <**Options**> → **Shooting mode** → **Smile** → <**Back**>.
- 4 Make any necessary adjustments.
- 5 Press the Confirm key.
- 6 Aim the camera lens at your subject.
Your phone recognises people in an image and detects their smiles. When the subject smiles, the phone automatically takes a photo.

› Capture a panoramic photo

You can capture wide panoramic photos using Panorama shooting mode. This mode is convenient for photographing landscapes.

- 1 In Menu mode, select **Camera** to turn on the camera.
- 2 Rotate the phone anti-clockwise to landscape view.
- 3 Press <**Options**> → **Shooting mode** → **Panorama** → <**Back**>.
- 4 Make any necessary adjustments.
- 5 Press the Confirm key to take the first photo.
- 6 Slowly move the phone in the direction you selected and align the frame with the viewfinder.
When you have aligned the frame and viewfinder, the camera will automatically capture the next photo.
- 7 Repeat step 6 to complete the panoramic photo.

› Record a video

- 1 In Menu mode, select **Camera** to turn on the camera.
- 2 Rotate the phone anti-clockwise to landscape view.
- 3 To switch to the camcorder, press <**Options**> → **Mode** → **Camcorder**.
- 4 Aim the lens at the subject and make any necessary adjustments.
- 5 Press [**▲**/**▼**] to zoom in or out.
- 6 Press the Confirm key to start recording.
- 7 Press <**Stop**> to stop recording.
The video is saved automatically.

After recording videos, press <**View**> to view the captured videos.

Media browser

Learn to view photos and play videos saved in your phone's memory and memory card.



- Some file formats are not supported depending on the software of the phone.
- If the file size exceeds the available memory, an error can occur when you open files.

› View a photo

- 1 In Menu mode, select **Apps** → **Media browser**.
- 2 Select a category → a photo (with no icon) to view.

› Play a video

- 1 In Menu mode, select **Apps** → **Media browser**.
- 2 Select a category → a video (with a play icon) to play.
- 3 Press the Confirm key to begin playback.

› Play a slideshow

You can view all of your photos and videos as a slideshow.

- 1 In Menu mode, select **Apps** → **Media browser**.
- 2 Select a category → **<Options>** → **Slide show**.
- 3 Rotate the phone to anti-clockwise to landscape view.

Music

Learn to listen to your favourite music while on the go with the music player.

› Add music files to your phone

Start by transferring files to your phone or memory card:

- Download from the wireless web. ▶ p. 50
- Download from a PC with the optional Samsung Kies. ▶ p. 58
- Receive via Bluetooth. ▶ p. 57

- Copy to your memory card. ▶ p. 59
- Synchronise with Windows Media Player 11. ▶ p. 59

› Play music

After transferring music files to your phone or memory card,

- 1 In Menu mode, select **Music** → **Library**.
- 2 Select a music category → a music file.
- 3 Control playback with the following keys:

Key	Function
Confirm	Pause or resume playback.
Volume	Adjust the volume.

Key	Function
Navigation	<ul style="list-style-type: none"> • Up: Access the playlist. • Down: Change the repeat mode. • Left: Skip backward; Scan backward in a file (press and hold). • Right: Skip forward; Scan forward in a file (press and hold).

› Create a playlist

- 1 In Menu mode, select **Music** → **Library** → **Playlists**.
- 2 Press <**Options**> → **Create playlist**.
- 3 Enter a title for your new playlist and press the Confirm key.
- 4 Select the new playlist.
- 5 Press <**Options**> → **Add** → **Tracks**.
- 6 Select the files you want to include and press <**Add**>.

› Find information of music

Learn to access an online music service to get information about a song.



- This service is not available from some service providers.
- The database may not include information for all songs.

- 1 In Menu mode, select **Music** → **Find music**.
- 2 Press the Confirm key to record a part of a song. After 10 seconds, the recording will stop automatically.
- 3 Follow the on-screen instructions to send the recording to the music information server.

FM radio

Learn to listen to music and news on the FM radio. To listen to the FM radio, you must connect the supplied headset, which serves as the radio antenna.

› Listen to the FM radio

- 1 Plug the supplied headset into the phone.
- 2 In Menu mode, select **Apps** → **FM radio**.
- 3 Press the Confirm key → **<Yes>**.
The FM radio scans and saves available stations automatically.

 The first time you turn on the FM radio, you will be prompted to start automatic tuning.

- 4 Control the FM radio with the following keys:

Key	Function
Confirm	Turn off the FM radio on or off.

Key	Function
Volume	Adjust the volume.
Navigation	<ul style="list-style-type: none">• Up/Down: Select a radio station saved in the favourites list.• Left/Right: Search for an available radio station.

To get information about a song you hear on the FM radio, press **<Options>** → **Find music**. ► p. 41

To add the current radio station to the favourites list, press **<Options>** → **Add to** → **Favourites**.

› Save radio stations automatically

- 1 Plug the supplied headset into the phone.
- 2 In Menu mode, select **Apps** → **FM radio**.
- 3 Press **<Options>** → **Self-tuning**.

- 4 Press <Yes> to confirm.
The FM radio scans and saves available stations automatically.

› Set programme reminders

You can set the phone to alert you to listen to the radio at a specified time.

- 1 Plug the supplied headset into the phone.
- 2 In Menu mode, select **Apps** → **FM radio**.
- 3 Press <Options> → **Programme reminder**.
- 4 Press <Create> or <Options> → **Create reminder**.
- 5 Set reminder details and press <Save>.

When a pop-up notification appears and the FM radio turns on, press <Listen> to listen to the specified radio station.

Games and more

Learn to use games and applications powered by award-winning Java technology.



The download of Java games or applications may not be supported depending on the software of the phone.

› Download games and applications

- 1 In Menu mode, select **Apps** → **Games and more** → **More games**.
Your phone connects to the website preset by your service provider.
- 2 Search for a game or application and download it to the phone.



This feature may be unavailable depending on your region or service provider.

› Play games or launch applications

- 1 In Menu mode, select **Apps** → **Games and more**.
- 2 Select a game or application from the list and follow the on-screen instructions.



- Available games or applications may vary depending on your region or service provider.
- Controls and options of games or applications may vary.

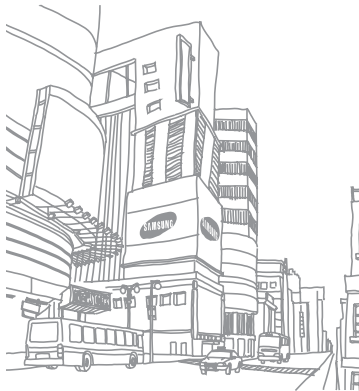

Personal information

Contacts

Learn to create and manage a list of your personal or business contacts stored on the phone's memory or a SIM or USIM card. You can save names, mobile phone numbers, home phone numbers, email addresses, birthdays and more for your contacts.

› Create a contact

- 1 In Menu mode, select **Contacts**.
- 2 Press the Confirm key → a memory location.
If there is a contact saved, press <**Options**> → **Create contact** → a memory location.
- 3 Enter contact information.



If you are saving the contact on a SIM or USIM card, you can save only the contact's name and a phone number.

- 4 Press the Confirm key to add the contact to memory.

You can also create a contact from the dialling screen.

- 1 In Idle mode, enter a phone number using the keypad and press <**Options**>.
- 2 Select **Add to Contacts** → **Create contact** → a memory location.
- 3 Select a number type.
- 4 Enter contact information.
- 5 Press the Confirm key to add the contact to memory.

› Find a contact

- 1 In Menu mode, select **Contacts**.
 - 2 Enter the first letter of the name you want.
 - 3 Select the contact's name from the contact list.
-  Once you found a contact, you can:
- call the contact by pressing [**↵**].
 - edit the contact information by pressing the Confirm key.

› Set a favourite number

- 1 In Menu mode, select **Contacts**.
- 2 Scroll to a contact to assign.
- 3 Press <**Options**> → **Add to Favourites**.
- 4 Select a favourite number you want to set.
The contact is saved to the favourite number list.



You can now call this contact from Idle mode by pressing and holding the corresponding the assigned favourite number.

› Create a group of contacts

By creating groups of contacts, you can manage multiple contacts and send messages or email to an entire group. Start by creating a group.

- 1 In Menu mode, select **Contacts**.
- 2 Scroll left or right to **Groups**.
- 3 Press <**Options**> → **Create group**.
- 4 Select a memory location (if necessary).
- 5 Enter a group name and press the Confirm key.

Calendar

Learn to create and manage daily, weekly or monthly events.

› Create an event

- 1 In Menu mode, select **Organiser** → **Calendar**.
- 2 Press <**Options**> → **Create** → an event type.
- 3 Enter the details of the event as required.
- 4 Press the Confirm key.

› View events

To change the calendar view,

- 1 In Menu mode, select **Organiser** → **Calendar**.
- 2 Press <**Options**> → **View by week** or **View by month**.

To view events of a specific date,

- 1 In Menu mode, select **Organiser** → **Calendar**.
- 2 Select a date on the calendar. On the calendar, the dates with scheduled events are indicated with a triangle.
- 3 Select an event to view its details.

Task

Learn to create a virtual task list and set alarms to remind yourself of important tasks or set priority.

› Create a task

- 1 In Menu mode, select **Organiser** → **Task**.
- 2 Press <**Create**>.
- 3 Enter the details of the task.
- 4 Press the Confirm key.

› View tasks

- 1 In Menu mode, select **Organiser** → **Task**.
 - 2 Press <**Options**> → **List by** and select a category (priority, status, or due date) to sort the tasks.
 - 3 Select a task to view its details.
-  For completed tasks with an expired deadline, you can set their status to completed. You will not be reminded of those tasks any longer.

Memo

Learn to record important information to save and view at a later date.

› Create a memo

- 1 In Menu mode, select **Organiser** → **Memo**.

- 2 Press <**Create**>.
- 3 Enter your memo text and press the Confirm key.

› View memos

- 1 In Menu mode, select **Organiser** → **Memo**.
- 2 Select a memo to view its details.

Voice recorder

Learn to operate your phone's voice recorder.

› Record a voice memo

- 1 In Menu mode, select **Apps** → **Voice recorder**.
- 2 Press the Confirm key to start recording.

- 3 Speak into the microphone.
- 4 When you are finished, press <Stop>. Your memo is saved automatically.
- 5 To record more voice memos, press the Confirm key and repeat steps 3-4.

▶ Play a voice memo

- 1 In Menu mode, select **Apps** → **Voice recorder**.
- 2 Press <Options> → **Go to Sounds** to access the voice memo list.
- 3 Select a voice memo.
- 4 Control playback with the on-screen keys.

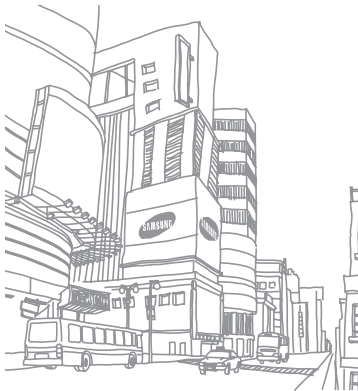

Web

Internet

Learn to access and bookmark your favourite web pages.



- You may incur additional charges for accessing the web and downloading media. For details, contact your service provider.
- The web browser menu may be labelled differently depending on your service provider.
- Available icons may vary depending on your region or service provider.

› Set up an internet profile

To access the network and connect to the internet, you must activate a connection profile. In addition to profiles that are preset by your service provider, you can add your own connection profile.

1 In Menu mode, select **Settings** → **Network** → **Connections** → <Yes>.

2 Press <**Options**> → **Create**.

3 Customise the network settings.

› Browse web pages

1 In Menu mode, select **Internet** to launch a specified homepage.

To access a specific web page, press <**Options**> → **Enter URL**, enter the web address (URL) of the web page, and press the Confirm key.

2 Navigate web pages.

› Bookmark your favourite web pages

You can bookmark web pages you frequently visit for quick access. While navigating the web, press <**Options**> → **Add to Bookmarks** to bookmark the current web page.

If you know the web address of the web page, you can manually add a bookmark offline. To add a bookmark,

- 1 In Menu mode, select **Internet** → **<Options>** → **Bookmarks** → **<Options>** → **Add bookmark**.

 The steps you must select to use this feature may differ depending on your region.

- 2 Enter a page title and a web address (URL).
- 3 Press the Confirm key.

› Use the RSS reader

Learn to use the RSS reader to receive the latest news and information from your favourite websites.

Add an RSS feed address

- 1 In Menu mode, select **Internet** → **<Options>** → **RSS feeds**.
- 2 Press **<Add>**.

- 3 If there is an RSS feed saved, press **<Options>** → **Add valid feed**.
- 4 Enter the address of an RSS feed and press the Confirm key.

Update and read RSS feeds

- 1 In Menu mode, select **Internet** → **<Options>** → **RSS feeds**.
- 2 Press **<Options>** → **Update** → feeds → **Update** → **<Yes>**.

 The auto update feature sets the phone to automatically update RSS feeds at specified intervals. You can activate the auto update feature by selecting **Internet** → **<Options>** → **Settings** → **RSS update**. Activating the auto update feature increases the amount of data downloaded and may incur additional charges.

Downloads

Learn to download a variety of media files, such as wallpapers, ringtones, games, music, and video clips.

- 1 In Menu mode, select **Downloads**.
- 2 Select a category.
- 3 Search for and download media files to the phone as desired.



As a result of the Digital Rights Management (DRM) system, some of the media items you download from the internet or receive by multimedia messages may require a licence key to access them. You can acquire the key from the website which owns the rights to the content.

Google

Learn to use various Google services, such as search, mail, and map services.



- Some services may be unavailable depending on your region or service provider.
- The steps you must follow to use this feature may differ depending on your region or service provider.

› Use the Google Search service

- 1 In Menu mode, select **Apps** → **Google** → **Search**.
- 2 Enter a letter or a word of the data to search.
- 3 Select the item's name you want to access.

› Use the Google Mail service

You can access your Google Mail account and send or read email messages on your phone.

- 1 In Menu mode, select **Apps** → **Google** → **Mail**.
- 2 Enter your user ID and password and log in.
- 3 Send or receive emails.

› Use the Google Maps service

- 1 In Menu mode, select **Apps** → **Google** → **Maps**.
- 2 Scroll through the map.
- 3 Zoom in or out on the location you want.

Synchronise

Learn to synchronise contacts, calendar events, tasks, and memos with the web server you have specified.

› Set up a synchronisation profile

- 1 In Menu mode, select **Apps** → **Synchronise**.
- 2 Press <**Add**> and specify the profile options.
- 3 When you are finished, press the Confirm key.

› Start synchronisation

- 1 In Menu mode, select **Apps** → **Synchronise**.
- 2 Select a synchronisation profile.
- 3 Press <**Continue**> to start synchronisation with the web server you have specified.

Communities

Learn to share your photos and videos with other people on community websites and blogs.



This feature may be unavailable depending on your region or service provider.

› Set your favourite website or blog list

- 1 In Menu mode, select **Comms.** → **Communities**.
- 2 Press <**Yes**> to set your favourite website or blog list (if necessary).

3 Press <**Accept**> to confirm that you agree to the general disclaimer.

 The first time you access the menu, you will be prompted to confirm.

4 Select the website or blog you want to add and press <**Save**>.

If you select <**Options**> → **Update lists**, new websites or blogs are added to the list automatically.

› Share a file

To upload or view photos and videos, you must have accounts with photo sharing websites and blogs.

1 In Menu mode, select **Comms.** → **Communities**.

2 Select a website or blog you want to access and press the Confirm key.

3 Press <**Options**> → **Add item** → a media file.

4 Enter the post details and press the Confirm key.

5 Enter the user ID and password and log in (if necessary).

 You can also upload media files from **Camera** or **My files** by pressing <**Options**> → **Upload to Web**.

Community websites

Use Facebook or Twitter services.

1 In Menu mode, select **Comms.** → **Facebook** or **Twitter**.

2 Enter your username and password and sign in.

3 Share photos, videos, or messages with friends and family.

Connectivity

Bluetooth

Bluetooth is a short-range wireless communications technology capable of exchanging information over a distance of about 10 metres without requiring a physical connection.



- Samsung is not responsible for the loss, interception, or misuse of data sent or received via the Bluetooth wireless feature.
- Always ensure that you share and receive data with devices that are trusted and properly secured. If there are obstacles between the devices, the operating distance may be reduced.
- Some devices, especially those that are not tested or approved by Bluetooth SIG, may be incompatible with your phone.

› Turn on the Bluetooth wireless feature

- 1 In Menu mode, select **Apps** → **Bluetooth**.
- 2 Press <**Options**> → **Settings**.
- 3 Press <**Change**> to activate the Bluetooth wireless feature.



To allow other devices to locate your phone, press <**Options**> → **Settings** → **My phone's visibility** → an option. If you selected **Custom**, set duration that your phone is visible.

› Find and pair with other Bluetooth-enabled devices

- 1 In Menu mode, select **Apps** → **Bluetooth**.
- 2 Press the Confirm key.

- 3 Enter a PIN for the Bluetooth wireless feature or the other device's Bluetooth PIN, if it has one, and press **<OK>**. Alternatively, press **<Yes>** to match the PIN between your phone and the device.

When the owner of the other device enters the same PIN or accepts the connection, pairing is complete. If the pairing is successful, the device will automatically search for available services.

Once the phone is paired with another Bluetooth-enabled device, the device icon will turn blue. Scroll to a paired device and use the following options:

- To browse the file directory of the device and exchange files, press the Confirm key.
- To search more devices, press **<Options>** → **Search**.
- To check Bluetooth services available on your phone and information about the services, press **<Options>** → **Service list**.

- To change the device name, press **<Options>** → **Rename**.
- To delete the paired device from the list, press **<Options>** → **Delete** or **Delete multiple**.
- To allow the device to access your phone without your confirmation, press **<Options>** → **Authorise**.

➤ Send data using the Bluetooth wireless feature

- 1 Select a file or item, such as a contact, calendar event, memo, task, or media file, from an appropriate application or **My files**.
- 2 Press **<Options>** → **Send via** → **Bluetooth**, or press **<Options>** → **Send namecard via** → **Bluetooth**.

➤ Receive data using the Bluetooth wireless feature

- 1 Enter the PIN for the Bluetooth wireless feature and press **<OK>** (if necessary).
- 2 Press **<Yes>** to confirm that you are willing to receive data from the device (if necessary).

Received data is saved to an appropriate application or folder according to its type. For example, a music or sound clip is saved to the sound folder and a contact to the phonebook.

➤ Print data using the Bluetooth wireless feature

- 1 Select a file or item, such as a message, contact, calendar event or image, from an appropriate application.

- 2 Press **<Options>** → **Print via** → **Bluetooth**, or press **<Options>** → **Print via Bluetooth**.
- 3 Search for and pair with a Bluetooth-enabled printer.
- 4 When connected to the printer, customise print options and print the data.

➤ Use Remote SIM mode

In Remote SIM mode, you can make or answer calls only with a connected Bluetooth hands-free car kit via the SIM or USIM card on your phone.

To activate Remote SIM mode,

- 1 In Menu mode, select **Apps** → **Bluetooth** → **<Options>** → **Settings**.
- 2 Scroll to **Remote SIM mode** and press **<Change>**.

To use Remote SIM mode, start the Bluetooth connection from a Bluetooth hands-free car kit.

GPS

Your device is equipped with a global positioning system (GPS) receiver. Learn to find your location and customise the GPS setting.

 This feature may be unavailable depending on your region or service provider.

To receive better GPS signals, avoid using your device in the following conditions:

- between buildings, in tunnels or underground passages, or inside buildings
- in poor weather
- around high voltage or electromagnetic fields

› Find your location

Learn to determine the latitude, longitude, and altitude of your current position using the GPS.

In Menu mode, select **Settings** → **Phone** → **GPS** → **GPS position**.

› Download GPS data files automatically

Learn to download GPS data files automatically from the GPS web server to enhance the GPS functionality. This improves the speed and accuracy of positioning capability.

 You may incur additional charges for downloading GPS data files.

In Menu mode, select **Settings** → **Phone** → **GPS** → **GPS+** → **Auto download** → **On**.

PC connections

Learn to connect your phone to a PC with an optional PC data cable in various USB connection modes.

› Connect with Samsung Kies

Ensure that Samsung Kies is installed on your PC. You can download the program from the Samsung website (www.samsungmobile.com).

- 1 In Menu mode, select **Settings** → **PC connections** → **Samsung Kies**.
- 2 Press [] to return to Idle mode.
- 3 Using an optional PC data cable, connect the multifunction jack on your phone to a PC.
- 4 Run Samsung Kies and copy data and files.

› Connect as a mass storage device

You can connect your phone to a PC as a removable disk and access the file directory. If you insert a memory card in the phone, you can also access the file directory of the memory card by using the phone as a memory card reader.

- 1 If you want to transfer files from or to a memory card, insert a memory card into the phone.
- 2 In Menu mode, select **Settings** → **PC connections** → **Mass storage**.

- 3 Press [] to return to Idle mode.
- 4 Using an optional PC data cable, connect the multifunction jack on your phone to a PC.
When connected, a pop-up window will appear on the PC.
- 5 Open the folder to view files.
- 6 Copy files from the PC to the memory card.

› Synchronise with Windows Media Player

Ensure that Windows Media Player is installed on your PC.

- 1 In Menu mode, select **Settings** → **PC connections** → **Media player**.
- 2 Press [] to return to Idle mode.

- 3 Using an optional PC data cable, connect the multifunction jack on your phone to a PC with Windows Media Player installed.
When connected, a pop-up window will appear on the PC.
- 4 Open Windows Media Player to synchronise music files.
- 5 Edit or enter your phone's name in the pop-up window (if necessary).
- 6 Select and drag the music files you want to the sync list.
- 7 Start synchronisation.

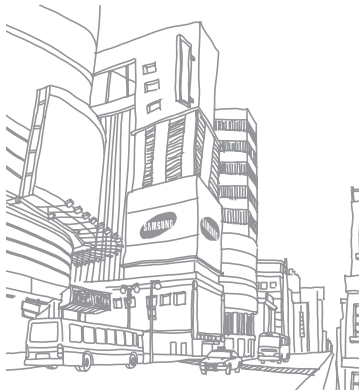

Tools

Alarms

Learn to set and control alarms for important events.

› Set a new alarm

- 1 In Menu mode, select **Organiser** → **Alarms**.
- 2 Press <**Create**>.
- 3 Set alarm details.
- 4 When you are finished, press <**Save**>.



The auto power-up feature sets the phone to automatically turn on and sound the alarm at the designated time when the phone is turned off.

› Stop an alarm

When the alarm sounds,

- Press <**OK**> to stop the alarm.
- Press <**Snooze**> to silence the alarm for the snooze period.

› Deactivate an alarm

- 1 In Menu mode, select **Organiser** → **Alarms**.
- 2 Scroll to the alarm you want to deactivate.
- 3 Press <**Options**> → **Deactivate alarm**.

Calculator

- 1 In Menu mode, select **Organiser** → **Calculator**.
- 2 Use the keys that correspond to the calculator display to perform basic mathematical operations.

Compass

- 1 In Menu mode, select **Apps** → **Compass**.
- 2 If you use the compass for the first time, press <Yes> and calibrate it by moving your phone as shown on the screen.

To use the compass, hold the phone flat in your palm, parallel to the ground and read the direction.



- Remove any metal jewellery and avoid coming too close to metal objects or places that affect the compass magnet. This may affect the accuracy of the direction reading.
- THE COMPASS PROVIDES GENERAL MEASUREMENTS FOR PERSONAL USE. AVOID USING THEM FOR ANY PURPOSE THAT IS PROHIBITED. INAPPROPRIATE USE MAY CAUSE DAMAGE OR DANGEROUS SITUATIONS THAT YOUR MANUFACTURER WILL NOT BE RESPONSIBLE FOR.

Convertor

- 1 In Menu mode, select **Organiser** → **Convertor** → a conversion type.
- 2 Enter the currencies or measurements and units in the appropriate fields.

Image editor

You can edit images and apply fun effects.

› Apply effects to images

- 1 In Menu mode, select **Apps** → **Image editor**.
- 2 Scroll to an image and press the Confirm key.
- 3 Press the Confirm key to edit the image.
- 4 Select **Effects** → an effect option (filter, style, or warp).
- 5 Select a variation of the effect to apply and press <Apply>.

To apply a blur effect to a specific area of an image, select **Partial blur**, move or resize the rectangle, and press the Confirm key.

- 6 When you are finished, press <**Options**> → **Save**.
- 7 Select a memory location (if necessary).
- 8 Enter a new file name for the image and press the Confirm key.

› Adjust an image

- 1 Open an image to edit.
- 2 Press the Confirm key to edit the image.
- 3 Select **Adjust** → an adjustment option (brightness, contrast, or colour).
- 4 Adjust the image as desired and press <**Apply**>.
- 5 Save the edited image with a new file name.

› Transform an image

- 1 Open an image to edit.
- 2 Press the Confirm key to edit the image.
- 3 Select **Resize**, **Rotate**, or **Flip**.
- 4 Rotate or flip the image as desired and press <**Apply**>. To resize the image, select a size option and press <**Save**>.
- 5 Save the edited image with a new file name.

› Crop an image

- 1 Open an image to edit.
- 2 Press the Confirm key to edit the image.
- 3 Select **Crop**.
- 4 Move the rectangle over the area to crop and press the Confirm key. To resize the rectangle, press <**Resize**>.

5 Save the edited image with a new file name.

› Insert a visual feature

1 Open an image to edit.

2 Press the Confirm key to edit the image.

3 Select **Insert** → a visual feature type (text, frame, emoticon, clip art, or image).

4 Select a visual feature, or enter text and press the Confirm key.

5 Move or resize the visual feature and press the Confirm key.

6 Save the edited image with a new file name.

My files

Learn to quickly and easily access all of your images, videos, music, sound clips, and other types of files stored on the phone or a memory card.

› Supported file formats

Your phone supports the following file formats:

Type	Supported format
Image	bmp, jpg, gif, png, wbmp, agif
Video	mp4, 3gp
Sound	imy, midi, pmd
Theme	thm
Others	doc, pdf, ppt, txt, xls, htm, html, vcf, vcs, vnt, jad, jar



- Some file formats are not supported depending on the software of the phone.
- If the file size exceeds the available memory, an error can occur when you open files.

› View a file

- 1 In Menu mode, select **My files** → a file type.
Folders or files on the memory card are indicated by a memory card icon.
- 2 Select a folder → a file.
 - In **Images**, you can view photos you have captured and images you have downloaded or received from other sources.
 - In **Videos**, you can play videos you have captured and ones you have downloaded or received from other sources.
 - In **Sounds**, you can play all ringtones, music files, and sound clips you have recorded, including voice memos and FM radio clips.
 - In **Themes**, you can view themes you have downloaded or received from other sources.
 - In **Others**, you can view documents and data files including unsupported files.

Pedometer

- 1 In Menu mode, select **Apps** → **Pedometer**.
- 2 Enter your height and weight and press <**Options**> → **Save**.
- 3 Press the Confirm key.
The pedometer will count your steps.
- 4 To stop the pedometer, press the Confirm key.

Search

Learn to search for data stored on your phone.

- 1 In Menu mode, select **Apps** → **Search**.
- 2 Enter a keyword of the data to search.
- 3 Select the data you want to access.

Stopwatch

- 1 In Menu mode, select **Apps** → **Stopwatch**.
 - 2 Press <**Start**> to begin the stopwatch.
 - 3 Press the Confirm key to record lap times.
 - 4 When you are finished, press <**Stop**>.
 - 5 Press <**Reset**> to clear recorded times.
-  While recording the lap times, the interval between lap times is recorded. To check the interval, select **Lap**.

Timer

- 1 In Menu mode, select **Apps** → **Timer**.
- 2 Set the length of time to count down.

- 3 Press <**Start**> to begin the countdown.
You can now use other functions with the timer counting down in the background. Press <**Back**> or [] → <**Yes**> and access another application.
- 4 When the timer expires, press <**OK**> to stop the alert.

World clock

Learn to view the time in another region and set world clocks to appear on your display.

› View a world clock

- 1 In Menu mode, select **Organiser** → **World clock**.
- 2 Scroll through the world map and select a time zone you want.

› Create a world clock

- 1 In Menu mode, select **Organiser** → **World clock**.
- 2 Press <**Add**> → <**Search**>.
- 3 Enter a city name or select one from the city list.
The world clock is set as the second clock.
- 4 To add more world clocks, repeat steps 2-3.

› Add a world clock to your display

With the dual clock widget, you can view clocks with two different time zones on your display.

After you have created world clocks,

- 1 In Menu mode, select **Organiser** → **World clock**.
- 2 Scroll to the time zone you want and press <**Options**> → **Set as second clock**.
- 3 In Menu mode, select **Settings** → **Display** → **Smart home**.

4 Scroll left or right to **Smart idle**.

5 Press <**Edit**> → **Dual clock**.

6 Press <**Options**> → **Save**.

Settings

Access the Settings menu

- 1 In Menu mode, select **Settings**.
- 2 Select a setting category and select an option.
- 3 Customise the setting and press <Save> or press the Confirm key.

Sound profiles

Select a sound profile to use or customise sound options in profiles as desired.

Display

Access and alter the following settings to control the display and usage of light on your phone.

- **Wallpaper:** Select a background image for the idle screen.
- **My theme:** Select a colour theme for the menu screens.
- **Smart home:** Change the idle screen type or customise the smart home screen.
- **Font style:** Select a font type for the display text.
- **Dialling display:** Customise the dialling screen.
- **Brightness:** Set the brightness of the display.
- **Backlight:** Set the length of time the phone waits before turning off the display's backlight.
- **Transition effect:** Set the phone to display animation when you switch between windows.

Time and date

Access and alter the settings to control how time and date are displayed on your phone.

Phone

Access and alter the following settings to control general settings for your phone:

- **Language:** Select a language to use on the phone's display and text input.
- **Shortcuts:** Customise the shortcut keys. ► p. 22
- **Keypad auto-lock:** Set the phone to automatically lock the keypad.
- **Keypad light:** Set the length of time the phone waits before turning off the keypad's backlight.
- **GPS:** Customise the settings related with GPS connections.

Call

Access and alter the following settings to control your phone's calling features:

- **All calls:** Customise the settings for calling features.

- **Voice call:** Customise the settings for voice calls.
- **Video call:** Customise the settings for video calls.
- **Fake call:** Customise the settings for fake calls. ► p. 28

Applications

Access and alter the following settings to control your phone's applications:

- **Messages:** Customise the settings for messaging features.
- **Email:** Customise the settings for email features.
- **Contacts:** Customise the settings for the phonebook.
- **Calendar:** Customise the settings for the calendar.
- **Internet:** Select a connection profile to use for accessing the internet. ► p. 50
- **Media player:** Customise the settings for the music player and video player.

Security

Access and alter the following settings to secure your phone and data:

- **Phone lock:** Activate or deactivate the phone lock feature to require a phone password before using the phone.
- **SIM lock:** Activate or deactivate the SIM lock feature to require the SIM or USIM password when you change the SIM or USIM card.
- **PIN lock:** Activate or deactivate the PIN lock feature to require the PIN before using the phone.
- **Privacy lock:** Make various types of data private; To access private data, you must enter your phone password.
- **Fixed dialling mode:** Activate or deactivate FDN mode to restrict calls to number in the FDN list.
- **Change password:** Change the phone password.
- **Change PIN:** Change the PIN used to access SIM or USIM data.

- **Change PIN2:** Change the PIN2, which is used to protect the primary PIN.
- **Mobile tracker:** Activate or deactivate the mobile tracker feature which helps you locate your phone when it is lost or stolen. ► p. 24

PC connections

Set a USB mode to be activated when you connect the phone to a PC. ► p. 58

Network

Access or alter the following settings to control how your phone selects and connects to networks:

- **Network selection:** Set the network selection method to automatic or manual.
- **Network mode:** Select a network band.

- **Connections:** Set up connection profiles to use for network features.
- **Certificates:** View certificates required for network services.

Profile wizard

Initiate the wizard that helps you customise your phone.

Memory

Access and alter the following settings to control your phone's memory use:

- **Memory card:** Access details about your memory card and set Bluetooth visibility for files in the memory card. You can also format the memory card or change the memory card's name.
- **Memory status:** View the used and available memory for various types of files.

- **Default memory:** Select the default memory location to use when transferring data, capturing images and videos, or recording voice memos or the FM radio.
- **Clear phone memory:** Erase the selected data from your phone's memory.



This will permanently erase all selected data from the phone's memory.

Reset

Reset various settings to the factory default values. Select which settings to reset. You must enter your phone password to reset the settings.

About phone

Check the open source licenses of downloaded programs.

Troubleshooting

When you turn on your phone or while you are using the phone, it prompts you to enter one of the following codes:

Code	Try this to solve the problem:
Password	When the phone lock feature is enabled, you must enter the password you set for the phone.
PIN	When using the phone for the first time or when the PIN requirement is enabled, you must enter the PIN supplied with the SIM or USIM card. You can disable this feature by using the PIN lock menu.

Code	Try this to solve the problem:
PUK	Your SIM or USIM card is blocked, usually as a result of entering your PIN incorrectly several times. You must enter the PUK supplied by your service provider.
PIN2	When you access a menu requiring the PIN2, you must enter the PIN2 supplied with the SIM or USIM card. For details, contact your service provider.

Your phone displays "Service unavailable" or "Network error"

- When you are in areas with weak signals or poor reception, you may lose reception. Move to another area and try again.
- You cannot access some options without a subscription. Contact your service provider for more details.

Calls are being dropped

When you are in areas with weak signals or poor reception, you may lose your connection to the network. Move to another area and try again.

Outgoing calls are not connected

- Ensure that you have pressed the Dial key.
- Ensure that you have accessed the right cellular network.
- Ensure that you have not set call barring for the phone number you are dialling.

Incoming calls are not connected

- Ensure that your phone is turned on.
- Ensure that you have accessed the right cellular network.
- Ensure that you have not set call barring for the incoming phone number.

Others cannot hear you speaking on a call

- Ensure that you are not covering the built-in microphone.
- Ensure that the microphone is close to your mouth.
- If using a headset, ensure that it is properly connected.

Audio quality is poor

- Ensure that you are not blocking the phone's internal antenna.
- When you are in areas with weak signals or poor reception, you may lose reception. Move to another area and try again.

When dialling from contacts, the call is not connected

- Ensure that the correct number is stored in the contact list.

- Re-enter and save the number, if necessary.
- Ensure that you have not set call barring for the contact's phone number.

The phone beeps and the battery icon flashes

Your battery is low. Recharge or replace the battery to continue using the phone.

The battery does not charge properly or the phone turns off

- The battery terminals may be dirty. Wipe both gold-coloured contacts with a clean, soft cloth and try charging the battery again.
- If the battery will no longer charge completely, dispose of the old battery properly and replace it with a new battery (refer to your local ordinances for proper disposal instructions).

Your phone is hot to the touch.

When you use applications that require more power or use applications on your phone for an extended period of time, your phone may feel hot to the touch. This is normal and should not affect your phone's lifespan or performance.

Safety precautions

To prevent injury to yourself and others or damage to your device, read all of the following information before using your device.

Warning: Prevent electric shock, fire, and explosion

Do not use damaged power cords or plugs, or loose electrical sockets

Do not touch the power cord with wet hands, or disconnect the charger by pulling on the cord

Do not bend or damage the power cord

Do not use your device while charging or touch your device with wet hands

Do not short-circuit the charger or the battery

Do not drop or cause an impact to the charger or the battery

Do not charge the battery with chargers that are not approved by the manufacturer

Do not use your device during a thunderstorm

Your device may malfunction and your risk of electric shock is increased.

Do not handle a damaged or leaking Lithium Ion (Li-Ion) battery

For safe disposal of your Li-Ion batteries, contact your nearest authorised service centre.

Handle and dispose of batteries and chargers with care

- Use only Samsung-approved batteries and chargers specifically designed for your device. Incompatible batteries and chargers can cause serious injuries or damage to your device.
- Never dispose of batteries or devices in a fire. Follow all local regulations when disposing of used batteries or devices.
- Never place batteries or devices on or in heating devices, such as microwave ovens, stoves, or radiators. Batteries may explode when overheated.
- Never crush or puncture the battery. Avoid exposing the battery to high external pressure, which can lead to an internal short circuit and overheating.

Protect the device, batteries, and chargers from damage

- Avoid exposing your device and batteries to very cold or very hot temperatures.
- Extreme temperatures can cause the deformation of the device and reduce the charging capacity and life of your device and batteries.
- Prevent batteries from contacting metal objects, as this can create a connection between the + and – terminals of your batteries and lead to temporary or permanent battery damage.
- Never use a damaged charger or battery.

Caution: Follow all safety warnings and regulations when using your device in restricted areas

Turn off your device where prohibited

Comply with all regulations that restrict the use of a mobile device in a particular area.

Do not use your device near other electronic devices

Most electronic devices use radio frequency signals. Your device may interfere with other electronic devices.

Do not use your device near a pacemaker

- Avoid using your device within a 15 cm range of a pacemaker if possible, as your device can interfere with the pacemaker.
- If you must use your device, keep at least 15 cm away from the pacemaker.
- To minimise the possible interference with a pacemaker, use your device on the opposite side of your body from the pacemaker.

Do not use your device in a hospital or near medical equipment that can be interfered with by radio frequency

If you personally use any medical equipment, contact the manufacturer of the equipment to ensure the safety of your equipment from radio frequency.

If you are using a hearing aid, contact the manufacturer for information about radio interference

Some hearing aids may be interfered with by the radio frequency of your device. Contact the manufacturer to ensure the safety of your hearing aid.

Turn off the device in potentially explosive environments

- Turn off your device in potentially explosive environments instead of removing the battery.
- Always comply with regulations, instructions and signs in potentially explosive environments.

- Do not use your device at refuelling points (service stations), near fuels or chemicals, and at blasting areas.
- Do not store or carry flammable liquids, gases, or explosive materials in the same compartment as the device, its parts, or accessories.

Turn off your device when in an aircraft

Using your device in an aircraft is illegal. Your device may interfere with the electronic navigation instruments of the aircraft.

Electronic devices in a motor vehicle may malfunction due to the radio frequency of your device

Electronic devices in your car may malfunction due to radio frequency of your device. Contact the manufacturer for more information.

Comply with all safety warnings and regulations regarding mobile device usage while operating a vehicle

While driving, safely operating the vehicle is your first responsibility. Never use your mobile device while driving, if it is prohibited by law. For your safety and the safety of others, practice good common sense and remember the following tips:

- Use a hands-free device.

- Get to know your device and its convenience features, such as speed dial and redial. These features help you reduce the time needed to place or receive calls on your mobile device.
- Position your device within easy reach. Be able to access your wireless device without removing your eyes from the road. If you receive an incoming call at an inconvenient time, let your voice mail answer it for you.
- Let the person you are speaking with know you are driving. Suspend calls in heavy traffic or hazardous weather conditions. Rain, sleet, snow, ice, and heavy traffic can be hazardous.
- Do not take notes or look up phone numbers. Jotting down a “to do” list or flipping through your address book takes attention away from your primary responsibility of driving safely.
- Dial sensibly and assess the traffic. Place calls when you are not moving or before pulling into traffic. Try to plan calls when your car will be stationary. If you need to make a call, dial only a few numbers, check the road and your mirrors, then continue.
- Do not engage in stressful or emotional conversations that may be distracting. Make people you are talking with aware you are driving and suspend conversations that have the potential to divert your attention from the road.
- Use your device to call for help. Dial a local emergency number in the case of fire, traffic accident, or medical emergencies.

- Use your device to help others in emergencies. If you see an auto accident, a crime in progress, or a serious emergency where lives are in danger, call a local emergency number.
- Call roadside assistance or a special, non-emergency assistance number when necessary. If you see a broken-down vehicle posing no serious hazard, a broken traffic signal, a minor traffic accident where no one appears injured, or a vehicle you know to be stolen, call roadside assistance or another special, non-emergency number.

Proper care and use of your mobile device

Keep your device dry

- Humidity and all types of liquids may damage device parts or electronic circuits.
- When wet, remove the battery without turning on your device. Dry your device with a towel and take it to a service centre.
- Liquids will change the colour of the label that indicates water damage inside the device. Water damage to your device can void your manufacturer's warranty.

Do not use or store your device in dusty, dirty areas

Dust can cause your device to malfunction.

Do not store your device on slopes

If your device falls, it can be damaged.

Do not store your device in hot or cold areas. Use your device at -20 °C to 50 °C

- Your device can explode if left inside a closed vehicle, as the inside temperature can reach up to 80 °C.
- Do not expose your device to direct sunlight for extended periods of time (such as on the dashboard of a car).
- Store the battery at 0 °C to 40 °C.

Do not store your device with such metal objects as coins, keys and necklaces

- Your device may become deformed or malfunction.
- If the battery terminals are in contact with metal objects, it may cause a fire.

Do not store your device near magnetic fields

- Your device may malfunction or the battery may discharge from exposure to magnetic fields.
- Magnetic stripe cards, including credit cards, phone cards, passbooks, and boarding passes, may be damaged by magnetic fields.

- Do not use carrying cases or accessories with magnetic closures or allow your device to come in contact with magnetic fields for extended periods of time.

Do not store your device near or in heaters, microwaves, hot cooking equipment, or high pressure containers

- The battery may leak.
- Your device may overheat and cause a fire.

Do not drop your device or cause impacts to your device

- The screen of your device may be damaged.
- If bent or deformed, your device may be damaged or parts may malfunction.

Do not use a flash close to the eyes of people or animals

Using a flash close to the eyes may cause temporary loss of vision or damage to the eyes.

Ensure maximum battery and charger life

- Avoid charging batteries for more than a week, as overcharging may shorten battery life.
- Over time, unused batteries will discharge and must be recharged before use.

- Disconnect chargers from power sources when not in use.
- Use batteries only for their intended purposes.

Use manufacturer-approved batteries, chargers, accessories and supplies

- Using generic batteries or chargers may shorten the life of your device or cause the device to malfunction.
- Samsung cannot be responsible for the user's safety when using accessories or supplies that are not approved by Samsung.

Do not bite or suck on the device or the battery

- Doing so may damage the device or cause explosion.
- If children use the device, make sure that they use the device properly.

When speaking on the device:

- Hold the device upright, as you would with a traditional phone.
- Speak directly into the mouthpiece.
- Avoid contact with your device's internal antenna. Touching the antenna may reduce the call quality or cause the device to transmit more radio frequency than necessary.
- Hold the device with a relaxed grip, press the keys lightly, use special features that reduce the number of keys you have to press (such as templates and predictive text), and take frequent breaks.

Protect your hearing



- Excessive exposure to loud sounds can cause hearing damage.
- Exposure to loud sounds while driving may distract your attention and cause an accident.
- Always turn the volume down before plugging the earphones into an audio source and use only the minimum volume setting necessary to hear your conversation or music.

Use caution when using the device while walking or moving

Always be aware of your surroundings to avoid injury to yourself or others.

Do not carry your device in your back pockets or around your waist

You can be injured or damage the device if you fall.

Do not disassemble, modify, or repair your device

- Any changes or modifications to your device can void your manufacturer's warranty. For service, take your device to a Samsung Service Centre.

- Do not disassemble or puncture the battery, as this can cause explosion or fire.

Do not paint your device

Paint can clog moving parts and prevent proper operation. If you are allergic to the paint or metal parts of the device, stop using the device and consult your physician.

When cleaning your device:

- Wipe your device or charger with a towel or a rubber.
- Clean the terminals of the battery with a cotton ball or a towel.
- Do not use chemicals or detergents.

Do not use the device if the screen is cracked or broken

Broken glass or acrylic could cause injury to your hands and face. Take the device to a Samsung Service Centre to have it repaired.

Do not use the device for anything other than its intended use

Avoid disturbing others when using the device in public

Do not allow children to use your device

Your device is not a toy. Do not allow children to play with it as they could hurt themselves and others, damage the device, or make calls that increase your charges.

Install mobile devices and equipment with caution

- Ensure that any mobile devices or related equipment installed in your vehicle are securely mounted.
- Avoid placing your device and accessories near or in an air bag deployment area. Improperly installed wireless equipment can cause serious injury when air bags inflate rapidly.

Allow only qualified personnel to service your device

Allowing unqualified personnel to service your device may result in damage to your device and will void your manufacturer's warranty.

Handle SIM cards or memory cards with care

- Do not remove a card while the device is transferring or accessing information, as this could result in loss of data and/or damage to the card or device.
- Protect cards from strong shocks, static electricity, and electrical noise from other devices.
- Do not touch gold-coloured contacts or terminals with your fingers or metal objects. If dirty, wipe the card with a soft cloth.

Ensure access to emergency services

Emergency calls from your device may not be possible in some areas or circumstances. Before travelling in remote or undeveloped areas, plan an alternate method of contacting emergency services personnel.

Keep in mind the followings for the water proof feature:

- **Your phone has been tested in a controlled environment and shown to be dust and water resistant in certain circumstances (meets requirements of classification IP67 as described by the international standard IEC 60529 - Degrees of Protection provided by Enclosures [IP Code]; test conditions: 15 - 35 °C, 86 - 106 kPa, 1 meter, for 30 minutes). Despite this classification, your phone is not impervious to water damage in any situation.**
- Improperly sealed covers, extended immersion in water, and/or excessive pressure may cause leaks and allow water to enter the phone. Do not intentionally immerse the phone in water, allow the phone to come in contact with water, or expose it to humidity.
- Improper sealing of covers, excessive exposure to dust and/or excessive pressure may cause dust penetration. Do not expose to dust and/or sand for extended periods of time.

- Your phone is a complex electronic device. Protect it from impact and rough handling to avoid serious damage. Damage to the phone's exterior may reduce its protection against water damage. Do not insert sharp objects into the speaker holes, microphone holes, or receiver holes, as this may puncture the protective surface and allow water and dust to enter.

Specific Absorption Rate (SAR) certification information

Your device conforms to European Union (EU) standards that limit human exposure to radio frequency (RF) energy emitted by radio and telecommunications equipment. These standards prevent the sale of mobile devices that exceed a maximum exposure level (known as the Specific Absorption Rate, or SAR) of 2.0 W/kg.

During testing, the maximum SAR recorded for this model was 0.665 W/kg. In normal use, the actual SAR is likely to be much lower, as the device has been designed to emit only the RF energy necessary to transmit a signal to the nearest base station. By automatically emitting lower levels when possible, your device reduces your overall exposure to RF energy.

The Declaration of Conformity statement at the back of this manual demonstrates your device's compliance with the European Radio & Terminal Telecommunications Equipment (R&TTE) directive. For more information about the SAR and related EU standards, visit the Samsung website.

Correct disposal of this product

(Waste Electrical & Electronic Equipment)



(Applicable in the European Union and other European countries with separate collection systems)

This marking on the product, accessories or literature indicates that the product and its electronic accessories (e.g. charger, headset, USB cable) should not be disposed of with other household waste at the end of their working life.

To prevent possible harm to the environment or human health from uncontrolled waste disposal, please separate these items from other types of waste and recycle them responsibly to promote the sustainable reuse of material resources.

Household users should contact either the retailer where they purchased this product, or their local government office, for details of where and how they can take these items for environmentally safe recycling.

Business users should contact their supplier and check the terms and conditions of the purchase contract. This product and its electronic accessories should not be mixed with other commercial wastes for disposal.

This EEE is compliant with RoHS.

Correct disposal of batteries in this product



(Applicable in the European Union and other European countries with separate battery return systems)

This marking on the battery, manual or packaging indicates that the batteries in this product should not be disposed of with other household waste at the end of their working

life. Where marked, the chemical symbols Hg, Cd or Pb indicate that the battery contains mercury, cadmium or lead above the reference levels in EC Directive 2006/66. If batteries are not properly disposed of, these substances can cause harm to human health or the environment.

To protect natural resources and to promote material reuse, please separate batteries from other types of waste and recycle them through your local, free battery return system.

Disclaimer

Some content and services accessible through this device belong to third parties and are protected by copyright, patent, trademark and/or other intellectual property laws. Such content and services are provided solely for your personal noncommercial use. You may not use any content or services in a manner that has not been authorised by the content owner or service provider. Without limiting the foregoing, unless expressly authorised by the applicable content owner or service provider, you may not modify, copy, republish, upload, post, transmit, translate, sell, create derivative works, exploit, or distribute in any manner or medium any content or services displayed through this device.

“THIRD PARTY CONTENT AND SERVICES ARE PROVIDED “AS IS.” SAMSUNG DOES NOT WARRANT CONTENT OR SERVICES SO PROVIDED, EITHER EXPRESSLY OR IMPLIEDLY, FOR ANY PURPOSE. SAMSUNG EXPRESSLY DISCLAIMS ANY IMPLIED WARRANTIES, INCLUDING BUT NOT LIMITED TO, WARRANTIES OF MERCHANTABILITY OR FITNESS FOR A PARTICULAR PURPOSE. SAMSUNG DOES NOT GUARANTEE THE ACCURACY, VALIDITY, TIMELINESS, LEGALITY, OR COMPLETENESS OF ANY CONTENT OR SERVICE MADE AVAILABLE THROUGH THIS DEVICE AND UNDER NO CIRCUMSTANCES, INCLUDING NEGLIGENCE, SHALL SAMSUNG BE LIABLE, WHETHER IN CONTRACT OR TORT, FOR ANY DIRECT, INDIRECT, INCIDENTAL, SPECIAL OR CONSEQUENTIAL DAMAGES, ATTORNEY

FEES, EXPENSES, OR ANY OTHER DAMAGES ARISING OUT OF, OR IN CONNECTION WITH, ANY INFORMATION CONTAINED IN, OR AS A RESULT OF THE USE OF ANY CONTENT OR SERVICE BY YOU OR ANY THIRD PARTY, EVEN IF ADVISED OF THE POSSIBILITY OF SUCH DAMAGES.”

Third party services may be terminated or interrupted at any time, and Samsung makes no representation or warranty that any content or service will remain available for any period of time. Content and services are transmitted by third parties by means of networks and transmission facilities over which Samsung has no control. Without limiting the generality of this disclaimer, Samsung expressly disclaims any responsibility or liability for any interruption or suspension of any content or service made available through this device.

Samsung is neither responsible nor liable for customer service related to the content and services. Any question or request for service relating to the content or services should be made directly to the respective content and service providers.

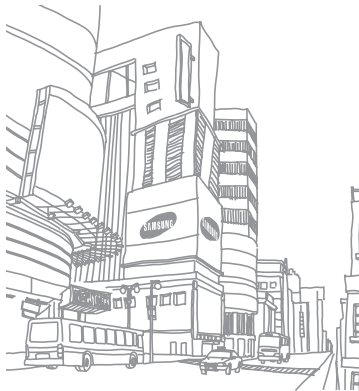

Index

access codes 72

alarms

- creating 61
- deactivating 61
- stopping 61

auto rejection 28

battery

- charging 10
- installing 8

Bluetooth

- activating 55
- finding and pairing with devices 55
- printing data 57
- receiving data 57

- Remote SIM mode 57
- sending data 56

brightness, display 21

calculator 61

calendar

- creating events 47
- viewing events 47

call log 29

calls

- answering 26
- international numbers 27
- making 26
- making fake 28
- rejecting 27

- using options during voice 27
- viewing missed 28

call time 30

camera

- capturing photos 37
- capturing videos 39

compass 62

contacts

- creating 45
- finding 46
- setting speed dial 46

converter 62

downloads

- Java games 43

email

- sending 35
- setting accounts 35
- viewing 36

fake calls 28

file manager 64

fixed dialling number mode 29

FM radio

- listening to 42
- saving stations 42

Google

- mail 52
- map 53
- search 52

GPS

- downloading GPS files
automatically 58
- finding your location 58

image editor

- adjusting 63
- applying effects 62

internet

- see web browser

Java games

- downloading 43
- playing 44

key tone

- volume 20

media browser 39

memory card

- formatting 14
- inserting 12
- removing 13

memos

- creating 48
- viewing 48

menu screen 20

message log 30

messages

- accessing voice mail 33
- managing 34
- sending email 35
- sending multimedia 32
- sending SOS 34
- sending text 31
- setting email accounts 35
- setting MMS profiles 31
- using templates 33
- viewing email 36
- viewing multimedia 32
- viewing text 32

mobile tracker 24

multimedia messages

- sending 32
- setting profiles 31

- viewing 32
- music player**
 - adding files 40
 - creating playlists 41
 - playing music 40
- PC connections**
 - mass storage 59
 - Samsung Kies 58
 - Windows Media Player 59
- pedometer** 65
- phone**
 - customising 20
 - indicator icons 18
 - keys 17
 - layout 15
 - locking 23
 - settings 68
 - turning on or off 15
- phonebook**
 - creating contacts 45
 - creating groups 46
 - finding contacts 46
 - setting favourite numbers 46
- phone lock** 23
- photos**
 - capturing 37
 - capturing in beauty mode 37
 - capturing in smile shot 38
 - capturing panoramic 38
 - editing 62
 - viewing 65
- PIN lock** 23
- RSS reader** 51
- silent profile** 21
- SIM card**
 - installing 8
- locking 23
- smart home screen** 22
- smart search** 65
- SOS messages** 34
- sound profiles** 21
- stopwatch** 66
- synchronisation**
 - with a web server 53
 - with Windows Media Player 59
- tasks**
 - creating 47
 - viewing 48
- text input** 25
- text memos** 48
- text messages**
 - sending 31
 - viewing 32

time and date, set 20

timer 66

unpack 8

USIM card

installing 8

locking 23

video calls

answering 26

making 26

videos

capturing 39

playing 65

voice calls

answering 26

making 26

using options 27

voice mail 33

voice memos

playing 49

recording 48

voice recorder 48

wallpaper 21

web browser

adding bookmarks 50

browsing web pages 50

setting profiles 50

Windows Media Player 59

world clock

creating 67

setting dual display 67

Declaration of Conformity (R&TTE)

We, Samsung Electronics

declare under our sole responsibility that the product

GSM WCDMA Mobile Phone : GT-B2710

to which this declaration relates, is in conformity with the following standards and/or other normative documents.

SAFETY	EN 60950-1 : 2006 +A11:2009
	EN 50332-1 : 2000
	IEC 60529 : 2001
EMC	EN 301 489-01 V1.6.1 (09-2005)
	EN 301 489-01 V1.8.1 (04-2008)
	EN 301 489-07 V1.3.1 (11-2005)
	EN 301 489-17 V2.1.1 (05-2009)
	EN 301 489-24 V1.4.1 (09-2007)
SAR	EN 50360 : 2001
	EN 62209-1 : 2006
RADIO	EN 301 511 V9.0.2 (03-2003)
	EN 300 328 V1.7.1 (10-2006)
	EN 301 908-1 V3.2.1 (05-2007)
	EN 301 908-2 V3.2.1 (05-2007)

We hereby declare that [all essential radio test suites have been carried out and that] the above named product is in conformity to all the essential requirements of Directive 1999/5/EC.

The conformity assessment procedure referred to in Article 10 and detailed in Annex[IV] of Directive 1999/5/EC has been followed with the involvement of the following Notified Body(ies):

BABT, Forsyth House,
Churchfield Road,
Walton-on-Thames,
Surrey, KT12 2TD, UK*
Identification mark: 0168

CE 0168

The technical documentation kept at :

Samsung Electronics QA Lab.

which will be made available upon request.
(Representative in the EU)

Samsung Electronics Euro QA Lab.
Blackbushe Business Park, Saxony Way,
Yateley, Hampshire, GU46 6GG, UK*
2010.08.24



Joong-Hoon Choi /Lab Manager

(place and date of issue) (name and signature of authorised person)

* It is not the address of Samsung Service Centre. For the address or the phone number of Samsung Service Centre, see the warranty card or contact the retailer where you purchased your product.

Some of the contents in this manual may differ from your phone depending on the software of the phone or your service provider.

SAMSUNG ELECTRONICS

