

**This .Pdf document is for informational purposes only and contains an Installation Template. The Template in this .Pdf document is not to scale. Do not use for sizing purposes.**

**Continue to next pages for Template instructions, Owners Guide and Humidistat Instructions.**

# Model HFT2100 Home Humidifier

## Installation Instructions and Mounting Template

### **⚠ Caution Plenum Opening Must Be Cut Accurately**

This product must be installed by a qualified heating and air conditioning contractor. Failure to do so could result in serious injury from electrical shock

### **Installation Options** This humidifier should not be installed where temperatures could exceed 180° F.

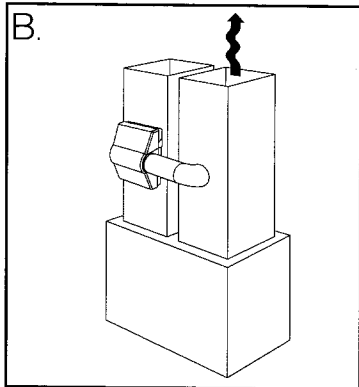
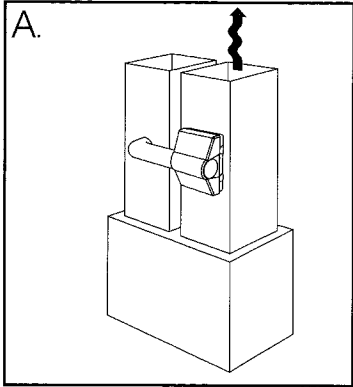

A. Mount the humidifier to the warm air plenum. Connect the unit to the cold air return using 6" round duct.

OR

B. Mount the humidifier to the cold air return. Connect the unit to the warm air duct using 6" round duct.

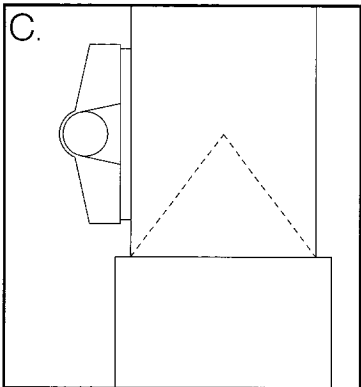

C. The White-Rodgers Model HFT2100 should be installed as shown in relation to AC cooling coils.

**Warning: Do Not install this unit where temperatures might exceed 180°F**

### **Wiring Diagram**

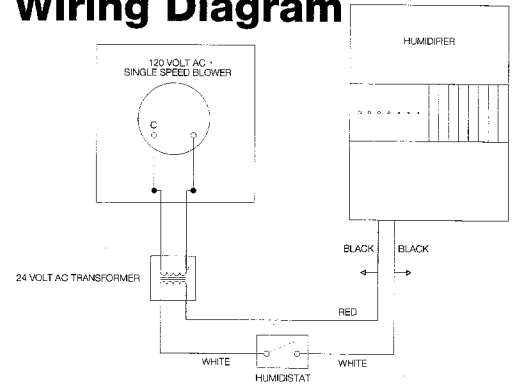

For multi-speed blowers or systems not using 120 VAC, use the A-50 Electronic Relay.

### **⚠ Warning**

1. 120 volts may cause serious injury from electrical shock. Disconnect electrical power to the furnace before starting the installation.
2. Sharp edges may cause serious injury. Use care when cutting plenum openings and handling ductwork.
3. Do not cut or drill into any air conditioning or electrical accessories during humidifier installation. Fatal electrocution is possible if you come into contact with a live electrical wire. Blindness can occur if freon contacts your eyes.

### **⚠ Caution**

1. Do not install where freezing temperatures could occur.
2. Do not install the unit on a furnace jacket.
3. Do not install the unit on a plenum face where the blanked-off ends of the cooling coil restrict air movement through the humidifier.
4. Do not set humidity higher than recommended. Condensation damage may result.
5. Do not set humidity up to recommended levels if there is condensation on the inside windows of any living space. Condensation damage may result.
6. Do not install the unit on the supply plenum where static pressure exceeds 0.4" W.C.
7. Do not install the unit where water pressure exceeds 125 psi. Leakage may result. Follow codes in effect concerning pressure reduction.
8. The installation, wiring and plumbing of the humidifier must comply with local codes, ordinances and regulations.

### **⚠ Caution Template Must Be Level**

See Reverse Side For Further Instructions

**WHITE-RODGERS**  
 Controlling Indoor Comfort Worldwide  
 Since 1937  
 St. Louis, Missouri      Markham, Ontario  
 314-577-1300              905-201-4701  
 www.white-roddgers.com

**EMERSON**  
 Climate Technologies

Use Outside Edge For Template Cutout

HBP Part No. 000-0752-213 2/02

# Installation Instructions

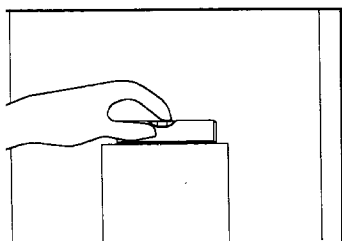

1. Tape the template onto the furnace plenum, **making sure it is level.**

Trace the four sides onto the plenum.

Remove the template from the plenum. **Accurately cut the plenum opening.**

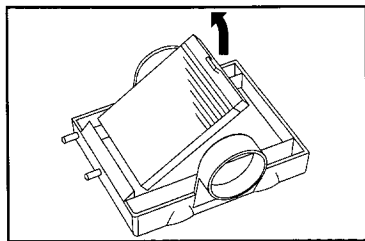

2. Disengage the humidifier cover from the mounting frame by rotating the thumb screw located at the bottom of the cover. Tilt and lift the cover off the frame.

Pull out the drip tray and evaporator pad assembly by grasping the top lip and tipping out.

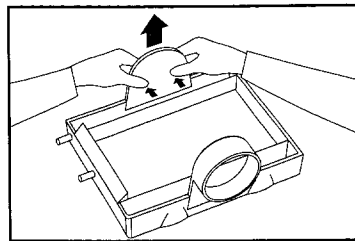

3. The humidifier is assembled for right side discharge. To convert from right to left side discharge, apply pressure to the inside of the side panel using both hands as the arrows indicate in the above illustration and lift out. Exchange the two side pieces and reinstall using moderate pressure.

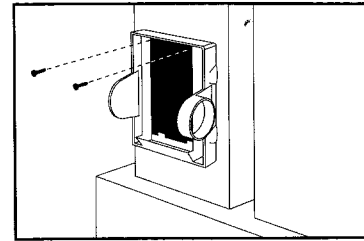

4. Place the mounting frame into the plenum opening so that the frame hooks over the bottom of the cut-out plenum opening. Screw the frame to the plenum with the screws provided.

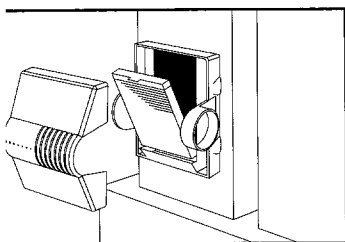

5. Reinstall the evaporator pad and drip tray.

Reattach the cover assembly by hooking it at the top of the mounting frame first, then securing with thumb screw at the bottom.

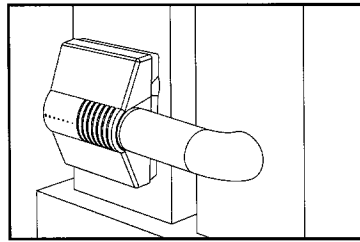

6. Install a 6" collar on the opposite plenum at the same height as the humidifier discharge collar. Slip on a 90° elbow and measure the length of 6" round duct required to make the connection. Attach the 6" duct to the discharge collar with the screws provided in the parts bag. If the furnace has central air conditioning, install the air shutter provided by placing it under one of the six mounting screws securing the by-pass collar.

NOTE: Flexible duct may be used.

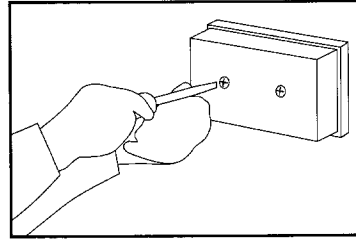

7. Locate and install the humidistat kit by following the detailed instructions found in the parts bag.

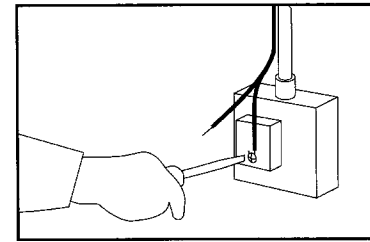

8. Shut off the furnace power and locate the blower motor junction box. Mount the 24 volt transformer on the box and tap the primary 120 volt leads to the motor wires. Wire the solenoid valve in series with the 24 volt terminals on the transformer and humidistat. See the wiring diagram on the front of the template.

**NOTE: For multi-speed blowers or systems not using 120 VAC, use the A-50 Electronic Relay.**

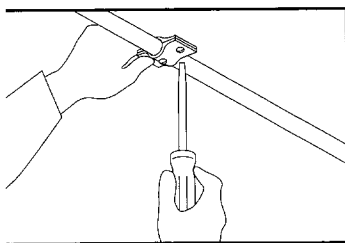

9. Tap into the water supply line using the saddle valve provided. Make sure to read directions on saddle valve bag.

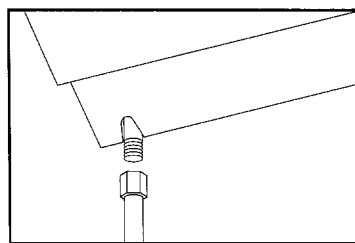

10. Connect copper tubing from the saddle valve to the solenoid valve. Check for leaks.

The saddle valve must be fully opened or closed. Do not use the valve to regulate water flow.

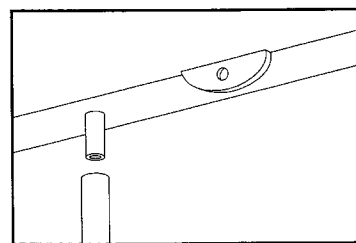

11. Attach a 1/2" I.D. vinyl hose and clamp to carry the flushing water from the unit to the drain. Be sure the drain hose has a constant pitch to the floor drain. **To avoid damage to the drain fitting, do not use solvent type adhesives when connecting the plastic hose to the humidifier.**

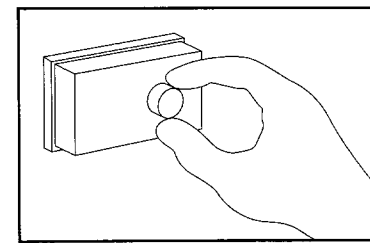

12. Test operation. Check for any water leaks. Be sure the humidistat is operating properly.

 **WHITE-RODGERS**

**Comfort**  
plus™

**MODEL HFT2100,  
HFT2700, HFT 2900FP  
HOME HUMIDIFIERS**

# **OWNER'S MANUAL**

**Includes Safety, Operating and Maintenance  
Instructions**

**CAUTION: READ THESE INSTRUCTIONS THOROUGHLY  
BEFORE SERVICING**

**FILL IN FOR HOME OWNER REFERENCE:**

**Model No.**  Model HFT 2100  Model HFT 2700  Model 2900FP

**Installation Date** \_\_\_\_\_

**SAVE THIS MANUAL FOR FUTURE REFERENCE**

 **WHITE-RODGERS**  
Controlling Indoor Comfort Worldwide  
Since 1937

St. Louis, Missouri      Markham, Ontario  
314-577-1300              905-201-4701  
[www.white-roddgers.com](http://www.white-roddgers.com)

  
**EMERSON**  
Climate Technologies

The Emerson logo is a trademark and a service mark of Emerson Electric Co.

HPB Part No. 000-0756-310 - Model HFT2100, HFT2700, HFT2900FP 2/02

## Contents

Introduction	1
Principle of Operation	2
Operating Instructions	3
Checking for Proper Operation	3
Maintenance for Models HFT2100, HFT2700 and HFT2900FP	4
Water Hardness and Maintenance Schedule	4
Homeowner Tips	5
Warranty	6

**WARNING:** Setting your humidity control higher than the listed setting could cause condensation that would damage your home. If excessive moisture appears on windows or walls, reduce humidity setting at humidistat enough to eliminate condensation. If the situation continues, turn off water valve and the humidistat until condensation is gone.

## Homeowner Tips

A. In a home that has had little or no humidification, allow approximately three weeks for your new humidifier to attain the desired humidity level. Your furniture, woodwork, carpeting, plaster, houseplants and family members all need time to absorb lost moisture.

B. To eliminate drafts that allow heat and humidified air to escape, keep fireplace dampers closed when not in use.

## Notes:

# Maintenance Instructions for HFT2100, HFT2700 & HFT2900FP

## **Danger - To Avoid Hazard of Electrical Shock or Burn Turn Off Power Supplying This Equipment Before Servicing.**

1. Shut off water supply.
2. Remove the humidifier cover by turning the screw located at the bottom of the cover and pulling the cover out toward you.
3. Tilt out the distribution tray and evaporator pad assembly.
4. All plastic and metal parts (except electrical parts and components) can be washed in humidifier cleaner or a 50% solution of vinegar and water.
5. Replace evaporator media, if cleaning is not satisfactory. This unit also contains a one piece wick. This wick must be changed along with the evaporator pad. The wick can be changed very easily by simply lifting out the old one and replacing it with the new one provided with the evaporator pad.
6. Evaporative media should be replaced at least once a year (once each heating season).
7. Wipe any loose sediment from the water tray (make certain no particles are allowed to plug the drain hole).

## **Water Hardness and Maintenance Schedule**

Your humidifier will accumulate minerals such as calcium and lime after operating for a short period (accumulation of minerals is a sure sign the humidifier is producing humidity). The amount of accumulation is dependent on the hardness of the water supply in your area. Therefore the time between cleaning is unpredictable.

NOTE: Excessive buildup of these minerals is detrimental to internal parts as well as evaporative efficiency. Refer to the maintenance instructions above to achieve years of satisfactory performance from your White-Rodgers Humidifier.

## **Congratulations...**

... on your purchase of a White-Rodgers High-Capacity Flow-Thru Humidifier—one of the finest home humidifiers made!

### **Caring for Your Humidifier**

Please take a few minutes to read this booklet. It will familiarize you with the many features and benefits of your new humidifier, and aid you in understanding the routine maintenance that will ensure many years of efficient operation.

If, at some point, you need parts or service to maintain the superior performance of your humidifier, follow these simple procedures:

- Contact the heating and air conditioning contractor who installed your unit. Often, this information can be found on a label attached to your humidifier or heating system.
- If no label is found, look in the yellow pages of your phone book under Heating & Air Conditioning Contractors.
- Finally, if these attempts for parts or service fail, write or call White-Rodgers at the address or phone number printed on the front inside cover or page 5 of this booklet.

# About Your White-Rodgers Humidifier

## Principle of Operation

Your White-Rodgers Humidifier uses the same method of evaporation you observe in nature after a summer shower. Mother Nature's technique is simple: warm air passes over a thin layer of water spread over a large area, causing the water to evaporate and raising the level of humidity. Your humidifier creates the same natural response with an evaporator pad that dispenses water evenly in front of a warm air stream.

You'll notice that the evaporator pad has many holes and connecting strands. These significantly increase the surface from which water can evaporate. This warm air evaporative process, is intensified by the warm air from your furnace, this is what makes your humidifier perform efficiently.

The system is controlled by a humidistat that monitors the relative humidity in your home, and activates or deactivates the humidifier accordingly. Water evaporated from the humidifier leaves behind all its impurities (e.g., calcium, iron, lime, bacteria, etc.), thus creating a purified vapor that doesn't pollute your indoor air. As a result, your home will be free from these contaminants... and your family will almost certainly be healthier and more comfortable.

## How Your Humidifier Works. . .

**Model HFT2100 & HFT2700.** When your home's air is dryer than the selected level of humidity, the humidistat activates the low-voltage solenoid in your humidifier, allowing water to flow across the unit's media. Warm, dry air is then forced through the humidifier cabinet by the furnace blower. As the warm air evaporates the water, the resulting moist (or humidified) air is circulated throughout your home by the heating system.

**Model HFT2900FP.** (White-Rodgers Model HFT2900FP operates identically to Model HFT2100 & HFT2700, except that warm air is forced through the humidifier cabinet by a humidifier fan rather than by the furnace blower.)

## Operating Instructions

Your new humidifier is controlled by a humidistat that is installed either on the cold air return of your furnace, or on an interior wall of your home. The recommended settings for this control may seem illogical until you understand the principle behind them....

As you can see from the Humidistat Settings chart below, the recommended setting goes down as the outside temperature decreases—just the opposite of how your furnace's thermostat operates. To understand the reason for this, think of what happens to an ice-cold drink when it's outside on a hot summer day... water (or condensation) forms on the outside of the glass. Condensation occurs because the hot summer air contains humidity, and the cold surface of the glass cools the surrounding air. Once cooled, the air molecules become smaller and can no longer hold as much moisture. The result is that water droplets accumulate on the glass.

The same principle applies to your home during the winter, when the outside temperature drops and the inside air remains warm and humid. In order to retain moisture in your home and prevent condensation, it's necessary to turn your humidistat down as outside temperatures fall.

## Recommended Humidistat Settings

At Outside Temperature	Recommended Setting	At Outside Temperature	Recommended Setting
-20°F. -29°C.	15%	+10°F. -12°C.	30%
-10°F. -23°C.	20%	+20°F. - 7°C.	35%
0°F. -18°C.	25%	Above 20° -7°C.	40%

## Checking the Humidifier for Proper Operation

To check your humidifier for proper operation after servicing or winter start-up, follow these procedures:

1. Turn the furnace blower to the OFF position, making sure the solenoid valve is closed.
2. Turn the furnace blower ON and set the humidistat to the full on position. The solenoid valve should open.
3. Make sure the water flow from the solenoid falls directly into the distribution tray. (The solenoid valve should limit the flow to approximately four gallons per hour at a line pressure of 60 P.S.I.)
4. To avoid overflow, run the humidifier long enough to be sure the drain tubing is carrying water to the waste line.

**▲ WARNING: DO NOT SET HUMIDITY CONTROL TOO HIGH. Use the recommended settings shown on humidistat nameplate.**

## 2271-100 HUMIDISTAT

WHITE-RODGERS

**Comfort**  
plus™

The humidistat is designed for **either return air duct or wall mounting**. Packaged in a duct mount configuration, **(For this type mounting begin installation at the section labeled return air duct installation on page 2.)** for conversion to a wall mount configuration simply pull off the knob and remove the mounting screws and rotate the control 180° and reattach the mounting base, **(For this type mounting begin installation at the section labeled wall mount installation on page 3.)**

### **DANGER**

- \* Do not cut or drill into any air-conditioning or electrical accessories during installation.
- \* Fatal electrocution is possible if you contact a live wire.
- \* Electrical power can cause electrical shock
- \* Disconnect all electrical power supplied to the equipment before beginning installation.
- \* Blindness can occur if freon contacts your eyes.

### **CAUTION**

- \* Do not install on any electrical system over 30 VAC

### **CAUTION**

- \* All electrical wiring should comply with codes and ordinances.

#### Recommended Settings

At Outside Temperatures	Recommended Setting
-20°F -30°C	15%
-10°F -25°C	20%
0°F -20°C	25%
+10°F -10°C	30%
+20°F -5°C	35%
Over 20°F Over 0°C	40%

### **WARNING**

Adjusting the humidity control higher than the recommended setting may cause condensation resulting in possible damage to the home.



## RETURN AIR DUCT INSTALLATION

- 1 Locate the humidistat in the return air duct at least 12 in. up stream prior to the humidifier or the humidifier by-bass tube.
- 2 Remove the backing and adhere the humidistat mounting template in a horizontal position, make sure it is level.
- 3 Drill four 7/64 in. mounting holes.
- 4 Drill 1/2 in. hole in the center of the template and use tin snips to cut the rectangular hole designated by the dotted lines then remove template.
- 5 Remove the backing and adhere the gasket over the opening area.
- 6 Connect the low voltage wires to the humidistat terminals. Tuck the wire into the recessed area on the back of the base plate.
- 7 Use sheet metal screws to securely fasten the humidistat to the return air duct.

### **⚠ CAUTION:**

- \* **Mount the humidistat in the return air duct only, installation on the warm air duct will destroy humidistat element.**
- \* **Make certain the wires stay in the slot under the mounting base.**

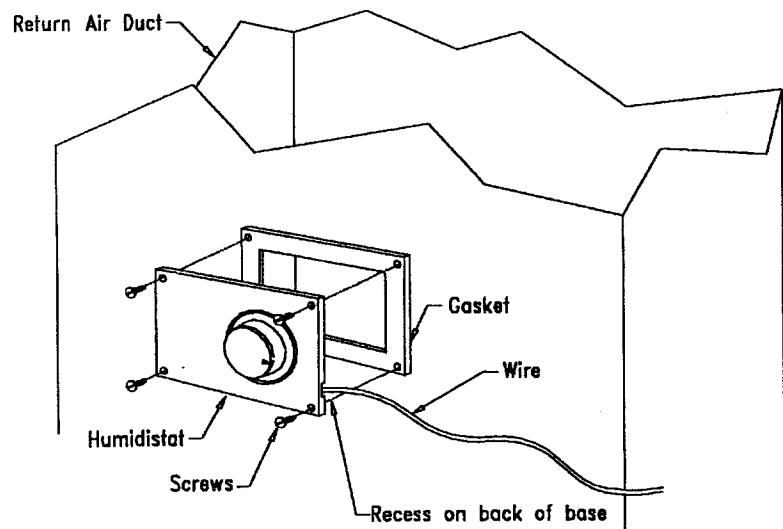

Figure 1 Wiring Diagram

## WALL MOUNT INSTALLATION

- 1 Locate the humidistat about 5 ft. above the floor, on an inside wall, away from discharge registers. Also, avoid areas with extreme variation in relative humidity levels; i.e. bathrooms and kitchens. When wall mounting, homeowners usually prefer the humidistat mounted beside, or in the vicinity of the heating thermostat.
- 2 **For conversion to a wall mount configuration, simply pull the indicator knob off and remove the mounting screws, and rotate the control 180° and reattach the mounting base Fig 2.**
- 3 Drill a 3/8 in. hole in the indentation on the mounting base plate.
- 4 Place the base assembly in the predetermined location on the wall, in a horizontal position, make sure it is level. Mark and drill a 3/8 in. hole in the wall.
- 5 Run low voltage wire to the location and pull about 6 in. of wire through the hole.
- 6 Plug the hole with a nonflammable insulation to prevent drafts from affecting the humidistat operation.
- 7 Position the base assembly over the wire and pull the wire through the hole previously drilled in the plate.
- 8 Use four 1 in. screws to secure the mounting base plate to the wall.
- 9 Connect the wires to the terminals on the control.
- 10 Use one 3/8 in. screw to secure the humidistat cover.
- 11 Remove the backing and adhere the cover label to the recessed area on the front of the cover.
- 12 Push the indicator knob onto the control shaft.

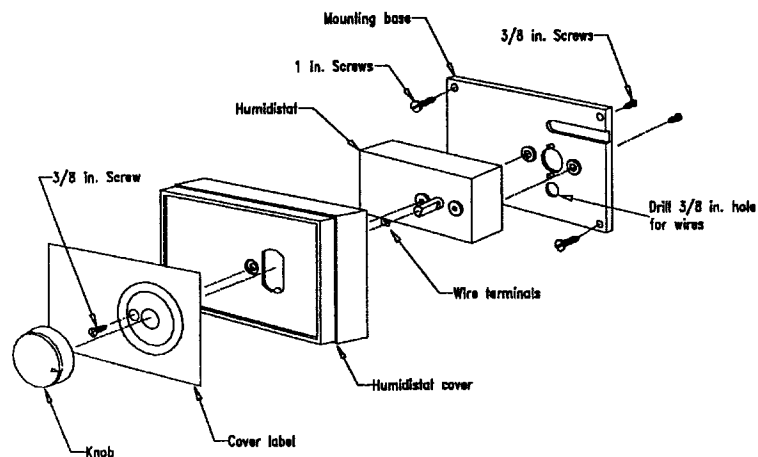

Figure 2 Wiring Diagram

## WIRING INSTRUCTIONS

### ⚠ CAUTION:

- \* Use the wiring diagram shown for single speed blower operation only.
- \* When wiring multispeed blower systems use a A50 relay or a fan sail switch to prevent premature component failure.
- \* Consult the instructions included with the humidifier and any additional controls for instructions on wiring.
- \* Fatal electrocution is possible if you contact a live wire.
- \* Electrical power can cause electrical shock
- \* Disconnect all electrical power supplied to the equipment before beginning installation.
- \* All electrical wiring should comply with codes and ordinances.

⚠ **Caution** When wiring a Model HFT2900FP or a Steam Humidifier Consult the Units wiring diagram. These Units Don't require an additional transformer.

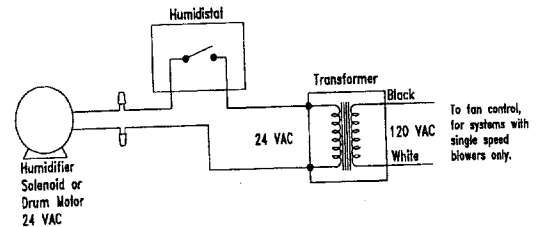

Figure 3 Wiring Diagram

### OPERATIONS CHECK

- 1 Turn the heating system thermostat up and wait until the system blower activates.
- 2 Turn the humidistat clockwise to the on position, visually check humidifier for operation.
- 3 Turn the humidistat counterclockwise to 10% or lower, visually check to see that humidifier shuts off.

**Note:** The set point where the humidistat turns on and off may not represent the actual indoor relative humidity, due to storage and transport environments. Allow at least 24 hours for humidity control to adjust to the installation.

- 4 Turn the humidistat to the recommended setting for operation (see the recommended settings chart on page 1).
- 5 Turn the system thermostat back to normal operation.

⚠ **WARNING** Adjusting the humidity control higher than the recommended setting may cause condensation resulting in possible damage to the home.

**WHITE-RODGERS**  
Controlling Indoor Comfort Worldwide  
Since 1937

www.white-roddgers.com