

Cuisinart™

INSTRUCTION
BOOKLET

Recipe
Booklet
Reverse Side



Cuisinart™ Griddler

GR-4A

For your safety and continued enjoyment of this product, always read the instruction book carefully before using.

IMPORTANT SAFEGUARDS

1. **READ ALL INSTRUCTIONS.**
2. Do not touch hot surfaces; use handles or knobs.
3. To protect against fire, electric shock, and injury to persons, **DO NOT IMMERSER CORD OR PLUG** in water or other liquids.
4. Close supervision is necessary when any appliance is used by or near children.
5. Unplug from outlet when not in use and before cleaning. Allow to cool before putting on or taking off parts, and before cleaning appliance.
6. Do not operate any appliance with a damaged cord or plug, or after the appliance has malfunctioned or has been damaged in any manner. Return the appliance to the nearest Cuisinart Repair Centre for examination, repair or adjustment.
7. The use of accessory attachments not recommended by Cuisinart may result in fire, electrical shock, or risk of injury to persons.
8. Do not use outdoors.
9. Do not let power cord hang over edge of table or counter, or touch hot surfaces.
10. Do not place on or near hot gas or electric burner, or in a heated oven.
11. Unplug the unit when finished using.
12. Do not use appliance for other than intended use.
13. Extreme caution must be exercised when moving an appliance containing hot oil or other hot liquids.
14. To disconnect, turn control to OFF setting, then remove plug from wall outlet.
15. **WARNING: TO REDUCE THE RISK OF FIRE OR ELECTRIC SHOCK, ONLY AUTHORIZED PERSONNEL SHOULD DO REPAIRS.**

This appliance is not intended for use by persons (including children) with reduced physical, sensory or mental capabilities, or lack of experience and knowledge, unless they have been given supervision or instruction concerning use of the appliance by a person responsible for their safety.

Children should be supervised to ensure that they do not play with the appliance.

The temperature of accessible surface may be high when the appliance is operating.

SAVE THESE INSTRUCTIONS

FOR HOUSEHOLD USE ONLY

SPECIAL CORD SET INSTRUCTIONS:

A short power-supply cord is provided to reduce the risks resulting from becoming entangled in or tripping over a longer cord.

Longer extension cords are available and may be used if care is exercised in their use.

If a long extension cord is used, the marked electrical rating of the extension cord should be at least as great as the electrical rating of the appliance, and the longer cord should be arranged so that it will not drape over the countertop or tabletop where it can be pulled on by children or animals, or tripped over.

TABLE OF CONTENTS:

Introduction	1
Parts and Features	2
Before the First Use	2
The Griddler Does it All	2
Assembly Instructions	4
Operating Instructions	5
Cleaning and Care	5
Storage	6
Warranty	6

INTRODUCTION

Congratulations on your purchase of the Cuisinart™ Griddler. This multifunctional product is actually four appliances in one. A hinged, floating cover, two sets of removable cooking plates and a convertible design turn the Griddler into a Contact Grill, a Panini Press, or your choice of a large, double Open Grill or Griddle. Dual temperature controls and indicator lights make this product easy to use. Dishwasher-safe grill plates, griddle plates, drip pans and a cleaning/scraping tool clean up in seconds.

PARTS AND FEATURES

- 1. Base and Cover:** Solid construction with stainless steel self-adjusting cover
- 2. Panini-Style Handle:** Sturdy cast metal handle adjusts cover to accommodate thickness of food
- 3. Removable Cooking Plates:** Nonstick and dishwasher safe for easy cleanup
 - a. Grill Plates:** Perfect for grilling steak, burgers, chicken and vegetables
 - b. Griddle Plates:** Prepare flawless pancakes, eggs, bacon and seared scallops
- 4. Controls:** Indicator lights signal “power on” and “ready to cook”
 - a. Selector:** Choose the Grill/Panini or Griddle function
 - b. Grill/Panini:** Adjust temperature from “warm” to “sear”
 - c. Griddle:** Adjust temperature from 95°C to 220°C
- 5. Drip Cups:** Collect grease and are dishwasher safe
- 6. Cleaning/Scraping Tool:** Helps clean grill or griddle plates after cooking
- 7. Plate Release Buttons:** Push in to release and remove cooking plates
- 8. Hinge Release Lever:** Allows the cover to lay back for cooking in the flat position

BEFORE THE FIRST USE:

Remove all packaging materials and any promotional labels or stickers from your grill. Be sure all parts (listed under **Parts and Features**) of your new appliance have been included before discarding any packaging materials. You may want to keep the box and packing materials for use at a later date.

Note: Drips cups are located on outside of left polyfoam insert.

Before using your Cuisinart™ Griddler for the first time, remove any dust from shipping by wiping the base, cover and controls with a damp cloth. Thoroughly clean cooking plates, drip trays and scraping tool. The grill and griddle plates, drip trays and cleaning tool are dishwasher safe. Refer to **Assembly Instructions** for plate removal.

THE GRIDDLER DOES IT ALL:

The Griddler is the ultimate kitchen appliance, offering you four separate cooking options. Simply change the cooking plates and adjust the hinge to use as a *Contact Grill*, *Panini Press*, *Open Grill* or *Griddle*. See **Assembly Instructions** and **Operating Instructions**.

Contact Grill:

Use the Griddler as a *Contact Grill* to cook burgers, boneless pieces of meat and thin cuts of meat and vegetables.

The *Contact Grill* function works best when you want to cook something in a short amount of time or when you are looking for a healthy method of grilling. When cooked on the *Contact Grill*, food will cook quickly because you are grilling both sides of the food item at the same time. The ribs on the grill plates combined with the grease spout at the corner of the plate allow the grease to drip from the meat and drain off the plates.

When the Griddler is used as a *Contact Grill* the grill plates are recommended. Rest the cover evenly on top of the food until it has reached the desired cooked temperature. The Griddler was designed with a unique handle and hinge that allows the cover to adjust to the thickness of the food. You can easily grill anything from a thinly-sliced potato to a thick sirloin steak with even results.

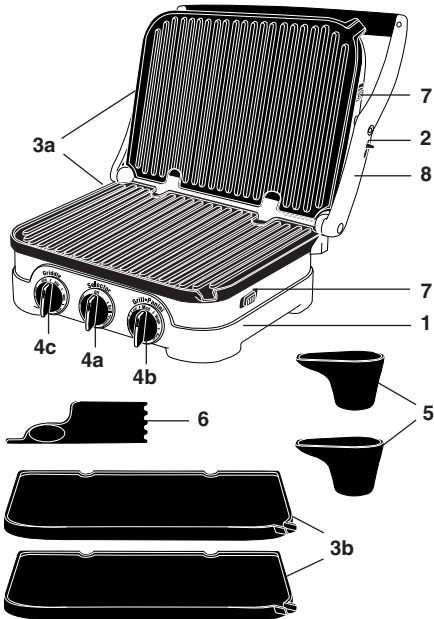

When cooking more than one food item in the *Contact Grill*, it is important that the thickness of food items is consistent so the cover will close evenly on the food.

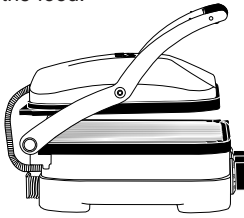

Panini Press:

Use the Griddler as a *Panini Press* to grill sandwiches, breads and quesadillas.

The word “Panini” is an Italian term for grilled sandwich. Panini can include any combination of ingredients such as vegetables, meat and cheese layered between two pieces of fresh baked bread. The sandwich is then pressed between two grill or griddle plates to toast the bread and warm the sandwich. Experiment to make a variety of savoury or sweet sandwiches for any meal. We recommend using fresh baked bread to produce the best tasting Panini. Popular breads used for Panini are focaccia (a flat bread frequently baked with rosemary, salt and onion on top), michetta (a small round roll with a crisp crust), ciabatta (a rectangular bread with a slightly domed crust) and thick slices of classic Italian bread.

When the Griddler is used as a *Panini Press*, the grill plates are recommended. We recommend the grill plates because a traditional-style Panini sandwich will have grill marks on the bread. However, depending upon the type of sandwich you are preparing, you may wish to use the griddle plates. The Griddler functions as a *Panini Press* in the same manner that it functions as a *Contact Grill*. The Griddler was designed with a unique handle and hinge that allows the cover to adjust to the thickness of the sandwich you are preparing, and to rest there evenly. Light pressure can be applied to the handle to press and heat the sandwich to your liking.



When cooking more than one Panini, it is important that the thickness of each sandwich is consistent so the cover will close evenly on the Panini.

Open Grill:

Use the Griddler as an *Open Grill* to cook burgers, steak, poultry (we do not recommend cooking bone-in chicken, since it does not cook evenly on an open grill), fish and vegetables.

Cooking on the *Open Grill* is the most versatile method of using the Griddler. In the open position, you have double the surface area (500 sq. cm) for grilling. You have the option of cooking different types of foods on separate plates without combining their flavors, or cooking large amounts of the same type of food. The open position also accommodates different cuts of meat with varying thicknesses, allowing you to cook each piece to your liking.

“Open Grill” refers to using the Griddler with the cover laying flat, creating a double, flat cooking surface. In this position, the foods you are grilling will have to be turned over for cooking. When the Griddler is used as an *Open Grill*, the grill plates should be used.

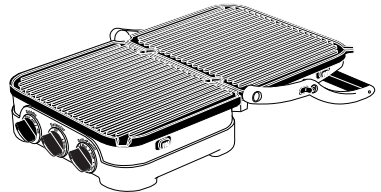

Griddle:

Use the Griddler as a *Griddle* to cook pancakes, eggs, French toast, hash browns and breakfast meats.

Using the *Griddle* function is a wonderful way to prepare breakfast for two or for a large family. The large surface area allows you to cook a variety of different foods at the same time, or large amounts of your favorite food.

When you use the Griddler as a *Griddle*, open the cover so it lays flat, creating a double, flat cooking surface. In this position, the foods you are preparing will have to be turned over for cooking. When using this cooking function, the griddle plates should be used.

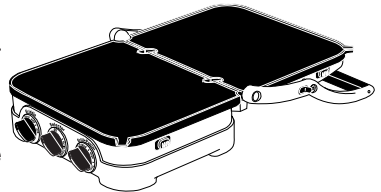

ASSEMBLY INSTRUCTIONS:

Place Griddler on a clean flat surface where you intend to cook.

The Griddler can be positioned in three ways:

Closed Position – Upper plate/cover rests flat on lower plate/base. This is your starting and heating position when using the Contact Grill or Panini Press functions.

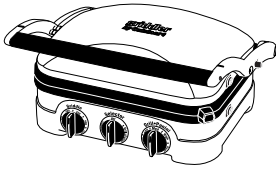

Open Position – Upper plate/cover is open and in the 100° position. Open the cover to this position before using the Griddler as a Contact Grill or Panini Press.

To adjust the Griddler to this position, simply lift the handle until you feel it come to a locking position. The unit will stay in this position until you close the cover or continue to open it to the Flat Position.



The cover will stay in the upright position until you lower the handle for cooking. When this is done, the cover will release itself so that it lies flat on top of the food you are preparing. This allows you to cook your food evenly from both top and bottom. When you lift the handle to open the Griddler after cooking the cover will remain in the flat position, parallel with the lower plate. In order to lock the cover back into the upright position, you must close the Griddler, without any food in place, and open it again.

Flat Position – Upper plate/cover is level with lower plate/base. The upper and lower plates line up to create one large cooking surface. The Griddler is in this position when it is used as an Open Grill or Griddle.

To adjust the Griddler to this position, locate the hinge release lever

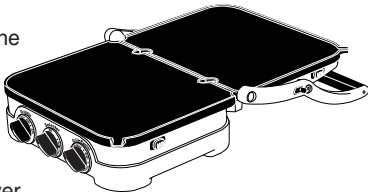

on the right arm. With your left hand on the handle, use your right hand to slide the lever toward you. Push the handle back until the cover rests flat on the counter. The unit will stay in this position until

you lift the handle and cover to return it to the closed position.

If the Griddler is already in the open position and you wish to adjust it to the flat position, pull the handle slightly toward you and then lift the hinge release lever. Push the handle back until the cover rests in the flat position. Pulling the handle forward slightly before lifting the hinge release switch will take some of the pressure off of the hinge and you will be able to adjust the Griddler more easily.



To insert cooking plates:

Adjust the Griddler to the Flat Position (see above) with the controls directly in front of you. Insert one plate at a time. Each plate is designed to fit in either the upper housing or the lower housing of the Griddler. The word “lower” or “upper” is embossed into each grill or griddle plate to let you know where to attach the plate. Pick up the lower grill/griddle plate with the cutouts for the heating element facing down. If you are facing the Griddler the drip spout should be at the forward right-hand corner of the plate. Locate the metal brackets at the centre of the housing. Tilt the back end of the plate and line up the cutouts at the back of the plate with the metal brackets. Slide the plate underneath the brackets and push down the front end of the plate. It will snap into place. Turn the Griddler around and insert the matching grill or griddle plate into the upper housing as you did with the first plate.

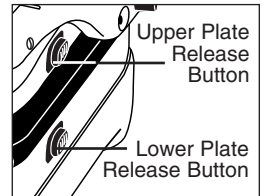

To remove cooking plates:

Adjust Griddler to Flat Position (see above). Locate the plate release buttons on one side of the unit. Press firmly on button and the plate will pop up slightly from the base. Grasp the plate with two hands, slide it out from under the metal brackets, and lift it out of the base. Press on the other plate release button to remove the other cooking plate in the same manner.

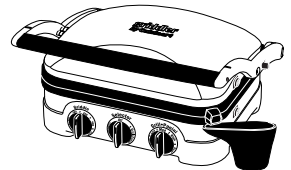

Position drip cups:

When using the Griddler as a Contact Grill or Panini

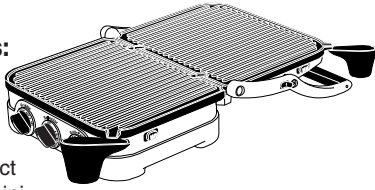

Press, only one drip cup is needed. Place the cup directly below the grease spout while cooking. Grease from the food will run off the plates through the grease spout and into the drip cups. Grease should be safely disposed of after cooking. The drip cups can be cleaned in the dishwasher.

When using the Griddler as an Open Grill or Griddle, both drip cups should be used. Place the cups at either end of the unit directly below the grease spouts.

Once the Griddler is assembled properly, plug the cord into a standard electrical outlet. You are now ready to begin cooking.

OPERATING INSTRUCTIONS:

Once the Griddler is assembled properly and you are ready to begin cooking, turn the Selector to the left to choose the Griddle function or to the right to choose the Grill/Panini function, depending on what you intend to cook. When the knob is turned to either function, a red indicator light will illuminate to indicate that the power is on.

If you intend to use the Griddler as a Contact Grill, Panini Press or Flat Grill, turn the Grill/ Panini Control to the desired temperature for cooking. Settings range from Warm (65°C) to Sear (230°C).

If you intend to use the Griddler as a Griddle, turn the Griddle Control to the desired temperature for cooking. Temperature settings range from 95°C to 220°C.

If you intend to use the Griddler as a Flat Grill or Griddle, but you do not need the entire surface, use the bottom plate.

It may take up to 10 minutes to reach operating temperature, depending on the temperature level that was set. When the thermostat has reached operating temperature, a green indicator light inside the chosen control will indicate that the Griddler is ready for cooking. During operation, the light will continue to turn on and off as the thermostat regulates the temperature. This is normal.

The temperature controls are used to set and maintain the temperature of the cooking surface. You may vary the setting of the control knob at any time during cooking, and may wish to do so depending on the types of foods on the cooking plate. Refer to the Cooked Food Temperature Chart on page 17 of the Recipe Book for recommendations.

Always exercise caution when handling the Griddler during cooking. To open the Griddler grasp the black plastic area of the handle. This part of the handle stays cool to the touch while cooking. The arms are made of die-cast aluminum and will become hot during use. Do not touch them during or immediately following cooking.

The Griddler housing will become hot during use. The cover is made of stainless steel and will become very hot and should not be touched during or immediately following cooking. If you need to adjust the cover be sure to use an oven mitt to prevent burns.

The lower housing is made of plastic, and while it will become very warm it will not burn you. If you need to move the Griddler during cooking be sure to handle it from the base only. Do not touch the cover.

Allow the Griddler to cool down before handling (at least 30 minutes).

NOTE: The first time you use the Griddler, it may have a slight odour and may smoke a bit. This is normal and common to appliances with nonstick surfaces.

The Griddler comes with a black cleaning/scraping tool. This can be used for cleaning the grill and griddle plates after you have finished cooking and the unit has cooled down completely (at least 30 minutes). Using the cleaning tool on a hot surface for too long will cause the plastic to melt.

User Maintenance:

- * Never use metal utensils, as they will scratch the nonstick plates. Instead, use only wooden or heat-proof plastic utensils.
- * Never leave plastic utensils in contact with the hot grill plates. This includes the provided cleaning tool.
- * In between recipes, scrape excess food buildup through grease channels and into drip cups, then wipe off any residue with a paper towel before proceeding with next recipe.
- * Allow the Griddler to cool down completely (at least 30 minutes) before cleaning.

CLEANING AND CARE:

CAUTION: BEFORE CLEANING APPLIANCE, MAKE SURE IT HAS COOLED DOWN COMPLETELY.

Once you have finished cooking, turn the Selector Control to the OFF position and unplug the power cord from the wall outlet. Allow the unit to cool down for at least 30 minutes before handling.

Use the cleaning/scraping tool to remove any leftover food from the cooking plate. The scraping tool can be washed by hand or in the dishwasher.

Dispose of grease from drip cups. The drip cups can be cleaned by hand or in the dishwasher.

Press the Plate Release Buttons to remove plates from the housing. Be sure that the plates have cooled completely before handling (at least 30 minutes). The cooking plates can be washed in

the dishwasher. Do not use metallic objects such as knives or forks for cleaning. Do not use a scouring pad for cleaning. The nonstick coating can be damaged.

If you have been cooking seafood, wipe the cooking plate with lemon juice to prevent seafood flavour transferring to the next recipe.

The housing base, cover and control knobs can be wiped clean with a soft, dry cloth. For tough stains, dampen cloth. Never use an abrasive cleaner or harsh pad.

STORAGE:

Always make sure the Griddler is cool and dry before storing.

The power cord can be wrapped around the back of the base for storing.

One set of cooking plates should be stored in the Griddler when not in use. The other set can be stored in a drawer or cabinet, along with the drip cups and scraping tool.

WARRANTY

Limited Three-Year Warranty

This warranty is available to consumers only. You are a consumer if you own a Cuisinart™ Griddler that was purchased at retail for personal, family or household use. Except as otherwise required under applicable law, this warranty is not available to retailers or other commercial purchasers or owners.

We warrant that your Cuisinart™ Griddler will be free of defects in materials and workmanship under normal home use for 3 years from the date of original purchase.

We suggest you complete and return the enclosed product registration card promptly to facilitate verification of the date of original purchase. However, return of the product registration card does not eliminate the need for the consumer to maintain the original proof of purchase in order to obtain the warranty benefits. In the event that you do not have proof of purchase date, the purchase date for purposes of this warranty will be the date of manufacture.

If your Cuisinart™ Griddler should prove to be defective within the warranty period, we will repair it, or if we think necessary, replace it. To obtain warranty service, simply call our toll-free number 1800 808 971 (AUST), 0800 435 000 (NZ) for additional information from our Customer Service Representatives or send the defective product to:

Cuisinart Australia
24 Salisbury Road
Asquith NSW 2077

or

Cuisinart New Zealand
44 Apollo Drive
Mairangi Bay
Auckland New Zealand

NOTE: For added protection and secure handling of any Cuisinart® product that is being returned, we recommend you use a traceable, insured delivery service. Cuisinart cannot be held responsible for in-transit damage or for packages that are not delivered to us. Lost and/or damaged products are not covered under warranty.

Please be sure to include your return address, daytime phone number, description of the product defect, product model # (located on bottom of product), original date of purchase, and any other information pertinent to the product's return.

Your Cuisinart™ Griddler has been manufactured to the strictest specifications and has been designed for use with the authorised accessories and replacement parts.

This warranty expressly excludes any defects or damages caused by accessories, replacement parts, or repair service other than those that have been authorised by Cuisinart.

This warranty does not cover any damage caused by accident, misuse, shipment or other ordinary household use.

This warranty excludes all incidental or consequential damages.

© 2008 Cuisinart
Cuisinart® is a registered trademark of Cuisinart
150 Milford Road, East Windsor, NJ 08520
Printed in China
04CU13024

IB-8/039

S&H1618/08