

MAAX®



PEARL

WHIRLPOOL BATH OWNER'S MANUAL

Safety, Operation, Maintenance, & Warranty SAFETY GUIDELINES

This manual contains information for you. This information relates to YOUR SAFETY and will also help in PREVENTING PROBLEMS. To help you recognize these items of importance, we will use the following symbols. PLEASE read the manual and pay special attention to these sections.

SAVE THESE INSTRUCTIONS!!!

! DANGER

URGENT SAFETY INFORMATION -
A HAZARD THAT *WILL* CAUSE SERIOUS
INJURY!

WARNING

IMPORTANT SAFETY INFORMATION -
A HAZARD THAT *MIGHT* CAUSE SERIOUS
INJURY!

CAUTION

Information for preventing damage to
equipment.

Model: _____

Serial #: _____

Owner's Record

Installation Date: _____

Installer's Name: _____

Address: _____

Telephone: _____

This information may be required for service and warranty.

**COMPLETE AND RETURN WARRANTY CARD
(ENCLOSED INSIDE)**

IMPORTANT SAFETY INSTRUCTIONS PERTAINING TO A RISK OF FIRE, ELECTRIC SHOCK, PERSONAL INJURY OR DAMAGE TO WHIRLPOOL.

WARNING WHEN USING THIS WHIRLPOOL, THESE BASIC PRECAUTIONS SHOULD BE FOLLOWED: READ AND FOLLOW ALL INSTRUCTIONS!

! DANGER The unit must be connected only to a supply circuit that is protected by a ground-fault circuit-interrupter (GFCI). Such a GFCI should be provided by the installer and should be tested on a routine basis. To test the GFCI, push the test button. The GFCI should interrupt power. Push the reset button. Power should be restored. If the GFCI fails to operate in this manner, the GFCI is defective. If the GFCI interrupts power to the bathtub without the test button being pushed, a ground current is flowing, indicating the possibility of an electric shock. Do not use this hydromassage bath. Disconnect the hydromassage bath and have the problem corrected by a qualified service representative before using.

(For permanently connected units) A green colored terminal (or a wire connector mark "G", "GR", "Ground", or "Grounding") is provided within the terminal compartment. To reduce the risk of electric shock, connect this terminal or connector to the grounding terminal of your electric service or supply panel with a conductor equivalent in size to the circuit conductors supplying this equipment.

! DANGER Never operate electrically connected devices in or near the bath. Never drop or insert any object into any opening. Do not use electrical appliances while in the tub.

To reduce the risk of injury, do not permit children to use this unit unless they are closely supervised at all times. Those requiring supervision for any reason, should never be allowed to use the whirlpool unattended.

Use this whirlpool only for its intended use as described in this manual. Do not use attachments not recommended by the manufacturer.

Do not use the whirlpool if the protective cover is not installed on the suction intake. Keep foreign objects, including hair, away from the suction intake as they could block the intake or get caught in it. For comfort and safety, persons with long hair should tie their hair up to keep it out of the water and away from the suction fitting. Never place your head below the surface of the water.

WARNING Tampering or modification of this whirlpool by anyone other than an authorized service technician will invalidate all warranties.

INSTALLER/OWNER BEARS ALL RESPONSIBILITY FOR COMPLYING WITH ALL STATE AND LOCAL CODES WHEN INSTALLING THIS UNIT. Access for each pump or blower, approximately 18" x 24" per access, is required to make each pump or blower available for servicing.

Persons under a doctor's care, pregnant women, persons with high or low blood pressure, heart disease, diabetes, or any serious illness, should not use a whirlpool without prior consultation with their physician. Never use a whirlpool while under the influence of any drugs or alcohol. The maximum temperature of the water should never exceed 104°F. Hot baths, showers, saunas or steam baths can put stress on the body.

CAUTION

- * To reduce risk of injury, enter and exit the bath carefully.
- * Do not fill the tub with water above the air volume controls or overflow.
- * Never run the whirlpool without water in the tub.

- * Do not bathe pets in your whirlpool. Their hair could clog the pump.
- * When filling the whirlpool with water, make sure the temperature does not exceed 104° F (60°C).
- * Damage and discoloration of the acrylic surface may occur.
- * The whirlpool should be drained after each use.
- * The use of oil based additives is not recommended unless you follow the cleaning instructions outlined in this book after each use of your whirlpool bath.
- * Do not use harsh abrasives or solvents for cleaning your whirlpool.

SAVE THESE INSTRUCTIONS

Table of Contents

Important Safety Instructions	1
Pearl Whirlpool Bath System	3
Pump	3
Whirlpool Jets	3
Air Volume Controls	3
Safety Suction Return System	3
Back Massage System	3
PearlAir System	3
In-Line Heater	4
Skirts	4
Mood Light(s)	5
Bath Waste	5
Valve & Hand Held Spray	5
Whirlpool On/Off	6
How To Use Your Whirlpool Bath	9
Water Temperature	9
Filling the Tub	9
Turning on the Whirlpool	9
Tuning your Whirlpool for Personal Pleasure	9
Bath Additives	9
Hints from Pearl	10
User Maintenance Instructions	11
Cleaning the Tub Surface	11
Commercial Installation (cleaning)	11
Cleaning the Pump and Plumbing System	11
Minor Scratches and Scuffs	11
Major Repair to the Surface	11
Jet Hardware Wrench	11
Trouble Shooting Guide	12
Description of Limited Warranty	13
Limited Warranty	14

Dear Homeowner,

Thank you for choosing Pearl. The minute you sit back and relax in your new bath you'll see *and* feel the difference. In your Pearl whirlpool, jets are strategically placed to create a soothing, swirling flow of relaxing water. *It's True Whirlpool®* action you'll only experience in a Pearl.

Relax and enjoy!! *There's only one True Whirlpool® Pearl.*

Sincerely,

Pearl Baths, Inc.

PEARL WHIRLPOOL BATH SYSTEM

Series-S (Standard Feature) O (An Option) NA (Not Available)

PUMP

Essence - S Designer - S Classic - S

Our commercial quality pump is the heart of your whirlpool system. The pump is positioned on a specially designed cantilevered mounting base. It helps isolate and dampen vibration and noise, adding to your comfort and pleasure. **The pump can (at times) take a minute or two to prime and begin water circulation.**

PATENTED WHIRLPOOL JETS

Essence - S Designer - S Classic - S

Pearl Whirlpool Bathtubs are not ordinary jetted tubs. Jet location in our tubs is designed to give you the very best in whirlpool bathing. Shown in fig. 1 is our Venturi jet. The nozzle is directionally adjustable and turns over a 30° range.

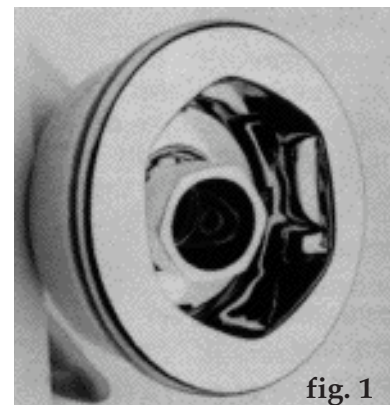

fig. 1

AIR VOLUME CONTROLS

Essence - S Designer - S Classic - S

Each jet is moving approximately 30 gallons of water per minute. The more air that is introduced into the flow of water, the deeper the massage. The amount of air is regulated by the air control knobs. Two air controls, (as shown in fig. 2) are located inside the tub. One knob controls a single jet. The other controls one or two whirlpool jets, depending on your model.

Do not fill the tub above the air controls or overflow.

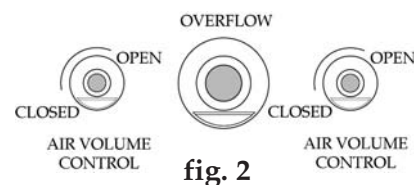

fig. 2

PATENTED SAFETY SUCTION RETURN SYSTEM

Essence - S Designer - S Classic - S

This fitting allows water to return from the tub to the pump. The protective louvered screen prevents foreign objects from entering the pump. **Do not use the whirlpool bath if protective cover is missing. Do not remove the protective louvered cover** (fig. 3). Keep the cover of the return fitting clean. An obstructed cover reduces the whirlpool action and may cause damage to the pump. To clean, remove any hair or debris and wash cover with a soft brush and soap. If blockage occurs, such as a foot, or hand too close to the return fitting, the pump instantly disengages and stops the whirlpool action until the obstruction is removed. Please do not be alarmed. This is a safety feature designed for your protection.

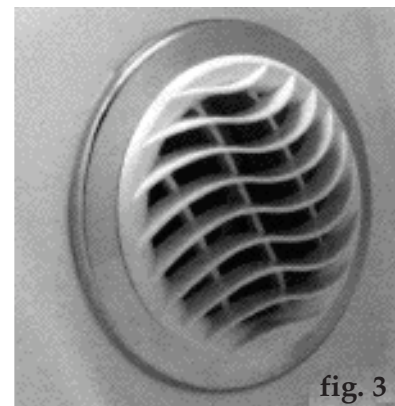

fig. 3

BACK MASSAGE SYSTEM/COMFORT PACKAGE

Essence - S Designer - O* (Selected Models) Classic - O (Selected Models)

* Not available with PearlAir System

Comprised of six rotating jets on ES and DS (8 on the Andorra), and four rotating jets on the CS, these ergonomically positioned jets provide a stimulating massage action to those sore tired muscles. The intensity of these rotating jets can be adjusted by turning the diverter valve located on the side of the bath (fig. 4).

PEARLAIR™ SYSTEM

Essence - NA Designer - O* (Selected Models) Classic - NA

* Not available with Back Massage System

Comprised of 10-14 air injectors (depending on the size of the whirlpool) these strategically placed bottom air jets provide a stimulating massage action. The system features a variable speed blower.

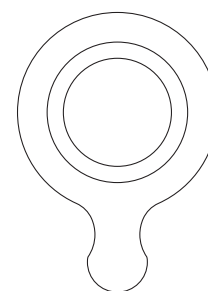

Off Position

Note: 1/4 turn to open back massage jets

fig. 4

IN-LINE HEATER

Essence - S

Designer - O*

Classic - O

* Not available with PearlAir System and the Ducetta

The In-Line Heater (fig. 5) is designed to maintain the starting water temperature. The heater is not a substitute for an adequately sized water heater. Proper water heater size should be determined by a plumber prior to the whirlpool installation. During bathing, it is normal to experience an impression that the water is cooling. This is the result of the body becoming acclimated to the water temperature. You may want to purchase a water thermometer to verify actual temperature. THE HEATER MUST HAVE A SEPARATE 20 AMP LINE (GFCI PROTECTED).

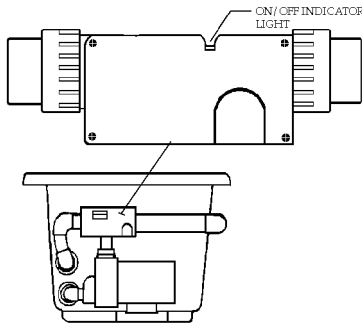

fig. 5

High Limit Reset Button

The heater includes an exclusive High Limit Reset. This limit control will not "false trip" from hot tap water. It will only turn the heater off if the thermostat fails. See instruction on heater for resetting high limit switch. If the High Limit trips frequently, call our Technical Service Department (fig. 5).

On/Off Indicator Light

This light turns on when the heater is in operation. When water has reached temperature set on thermostat control, the light will cycle on and off as heater maintains indicated temperature (fig. 5).

Safety Features

In addition to the thermostat control and High Limit Reset Button, the heater is also equipped with a built-in pressure switch. This switch will not allow the heater to turn on if the pump is not running.

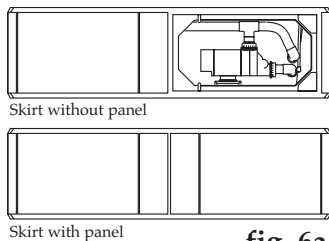

fig. 6a

WARNING

The thermostat is preset and not adjustable. Water temperature should never exceed 104° F. (40°C). Prolonged use in water temperature higher than this could induce hyperthermia. Hyperthermia occurs when the internal temperature of the body reaches a level several degrees above the normal body temperature of 98.6°F. The symptoms of hyperthermia include an increase in the internal temperature of the body, dizziness, lethargy, drowsiness, and fainting. The effects of hyperthermia include failure to perceive heat, failure to recognize the need to and the physical inability to exit the tub, unawareness of impending hazard and fetal damage to pregnant women. The effects of hyperthermia could include unconsciousness resulting in the danger of drowning.

WARNING

The use of alcohol, drugs or medication can greatly increase the risk of hyperthermia.

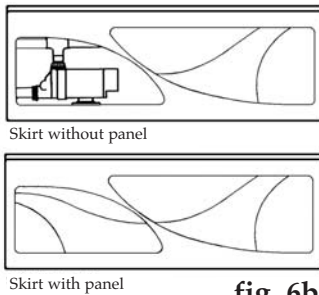

fig. 6b

SKIRT WITH REMOVABLE PANEL - Field Installed

Essence - NA

Designer - NA

Classic - O*

* Available on rectangular drop in units.

The front skirt is installed permanently in place by the installer. The panel can be pulled out (Fig. 6a) to service the pump.

INTEGRAL FLANGE & SKIRT WITH REMOVABLE PANEL

Essence - NA

Designer - S*

Classic - S**/O***

* Designer Series Models Standard, Metropolitan & Tranquil (Fig. 6c).

** Standard on Classic Series IFS Whirlpool Models.

***An Optional Removable Panel on IFS Tub Only Models (Fig. 6b).

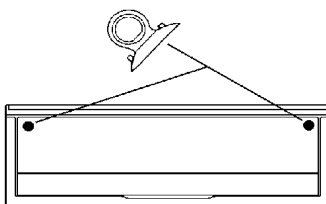

fig. 6c

The skirt and panel are standard features on these models. To remove the access panel, use the supplied suction cup to release one side of the panel at a time. Do not pull from the center of the panel.

BATH WASTE

Essence - S

Designer - S

Classic - O

The high quality bath waste that is included with your Pearl is cable operated, not the common linkage type found in most tubs which are subject to clogging problems. The drain plug has an adjustable screw and locking nut to vary the overall length of the plug. If the bath waste drain does not seal, turn in the screw and retighten the locking nut (fig. 7).

VALVES & HAND HELD SPRAY

Essence - S*

Designer - NA

Classic - NA

(* Except the Wisteria)

All Pearl Essence Series units, except the Wisteria, have these features. Designed for convenience and function, yet sculpted into their own special place. The spray is adjustable on the spray head itself, from full spray to stream. Push the diverter down to change from tub fill to hand held spray. The valves are ceramic requiring only a ¼ turn for on/off operation (fig. 8).

IMPORTANT

Proper installation of the connecting lines from the valves to the fill spout and hand held spray, in compliance with local codes is the responsibility of the installer. A vacuum breaker and/or temperature balanced valve may be required. Pearl Baths, Inc. does not warrant connections of water supply fittings and piping, fill systems or drain/overflow systems. Nor is it responsible for damage to the bath or home which occurs during any installation procedure.

MOOD LIGHTS

Essence - O Designer - O Classic - O

ALL SYSTEMS EXCEPT THOSE UTILIZING SMART-TOUCH CONTROL

One light - 5 different colored lenses.

Two lights -10 colored lenses (2 of each color).

Mood lights are controlled by a remote wall switch.

CHANGING LENS OR BULB:

! DANGER

Danger of electrical shock: Before changing a lens or bulb, drain tub and disconnect power.

- 1) Remove lens with special tool furnished.
- 2) Pull bulb straight out.
- 3) Gently push in new bulb.
- 4) Make certain that the "O" ring is in place.
- 5) Replace lens with tool.
- 6) Tighten with tool to align with notch.

These miniature light bulbs are available at lighting and hardware stores.
(12 Volt- 10 Watt)

SMART-TOUCH CONTROL SYSTEMS

One light or two lights - LED bulbs (not serviceable by the homeowner).

Mood lights are controlled by the Smart-Touch control. See page 7, **Turning the Bath Lighting On and Setting the Lighting Options**, for information on how to operate these lights.

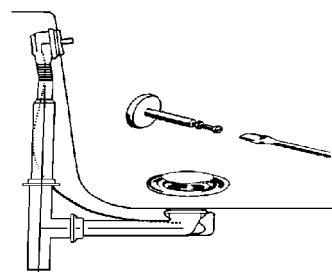

fig. 7

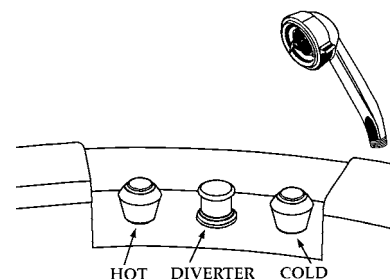

fig. 8

AIR SWITCH

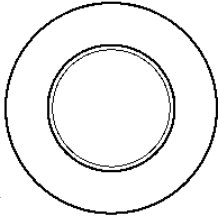

fig. 9a

PUMP CONTROL

SENSATOUGH BUTTON

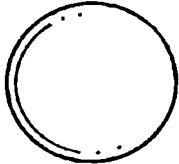

fig. 9b

ACTUAL SIZE

WATER LEVEL SENSING BUTTON FOR LOW WATER SHUT OFF

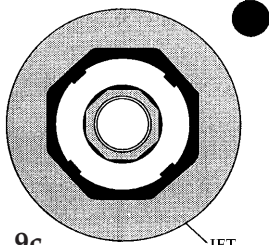

fig. 9c

JET

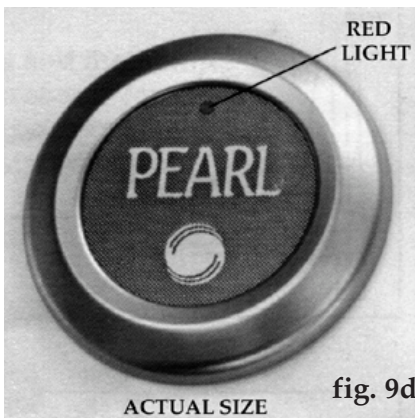

fig. 9d

ACTUAL SIZE

PEARL LOGO

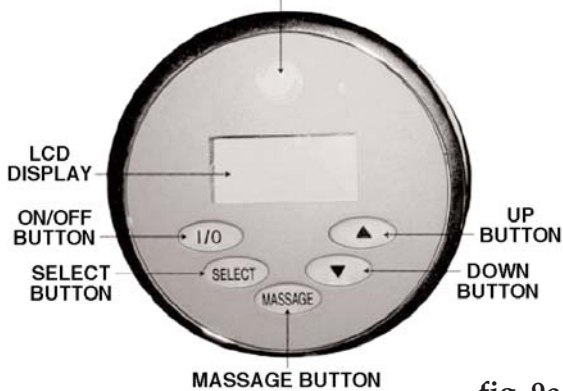

fig. 9e

WHIRLPOOL ON/OFF

AIR SWITCH PUMP CONTROL

Essence - NA Designer - NA Classic - S

The air switch pump control (fig. 9a) allows on/off control operations from within the tub.

SENSATOUGH™ ELECTRONIC WHIRLPOOL CONTROL

Essence - NA Designer - S Classic - O

The SensaTouch electronic control (fig. 9b) allows touch on/off operation from within the tub when water entirely covers the low water shut off button, (fig. 9c) located near the highest jet. The low water shut off also protects the pump from operating without water in the tub. This control includes an integral 20 minute timing function. **If wall switch is required by code, it should be left on at all times.**

MULTISPEED PUMP AND CONTROL

Essence - NA Designer - O Classic - O

Electronic control features on/off operation from within the tub when water is above sensing button. An integral 20 minute timing function is included. The Multispeed control (fig. 9d) allows the bather the choice of their own speed.

- Press  to start the whirlpool. Press again to turn off.
- Press and hold to change speeds. Press and hold through all speeds for massage mode.
- Whirlpool will turn off by pressing the button a second time or automatically after 20 minutes of operation. (Built in timer)
- Red light flashes four times if the water level in the tub is too low. Motor operates only when water is 2" over the highest whirlpool jet. A low water shut off near this jet protects the pump from operating without water.

SMART-TOUCH CONTROL

Essence - S Designer - S/O* Classic - NA*

** Standard on Ducetta. Comes with optional Back Massage and PearlAir.*

Note: Not all controller features work with every model of bath. To determine the model and accessories included with your bath, consult the documentation supplied with it. The accessories included with your bath at the time of purchase determine which controller features you can use.

Controller Operating Instructions

It is highly recommended that you familiarize yourself with the controller features (fig. 9e & 9f) and read all the instructions before operating the controller. Unless otherwise stated, you should proceed through the operating instructions in the order provide and in accordance with the accessories available with your tub.

Note: When the controller is initially powered up, the LCD and control buttons light up. After a few moments, "Config" appears on the LCD followed by a number (for example, #10). The number is a code identifying the accessories (pump, blower, lighting) included with your bath and is used for servicing (**do not attempt to service the controller yourself**). "Pearl Baths" then

appears on the LCD, indicating that the controller is ready to operate. In the unlikely event that a system error exists, the associated error code is displayed on the LCD before “Pearl Baths” is displayed.

When the bath is not in use, the LCD and control button lights go out; they light up again at the touch of a button. “Pearl Baths” remains displayed on the LCD until the controller detects water. When the bath is idle, the Dry Cycle may automatically activate. The Dry Cycle is available on all bath models equipped with a blower and is automatically activated 20 minutes after the controller has detected that no water is present in the bath.

Fill the bath with water. Once the controller detects the appropriate level of bath water, the Pearl Logo, LCD and control buttons light up, and the message “System Ready” appears on the LCD. This indicates that the bath controls can be set. At this point, you can choose to set the Water Temperature Display preference and/or operate the jetted bath. For more information, see the appropriate sections below.





Controller Features	Function	Availability
Pearl Logo 	<ul style="list-style-type: none"> Lights up when water is detected in the tub. 	<ul style="list-style-type: none"> Included with all models. Water is detected at a level above the highest jet.
LCD 	<ul style="list-style-type: none"> Displays the water temperature in Fahrenheit or Celsius (°F or °C) Displays options for all accessories. Displays error codes which are used for servicing. Do not attempt to service the controller yourself. 	<ul style="list-style-type: none"> Included with all models.
On / Off 	<ul style="list-style-type: none"> Sets the Timer run time for the pump and blower. Turns on/off the accessories included with your bath. Sets the water temperature display preference (°F or °C). 	<ul style="list-style-type: none"> Included with all models.
Select 	<ul style="list-style-type: none"> Allows you to scroll through the accessories list on the LCD. 	<ul style="list-style-type: none"> Included with all models.
Massage 	<ul style="list-style-type: none"> Activates Massage mode. 	<ul style="list-style-type: none"> Included with all models.
Up / Down 	<ul style="list-style-type: none"> Adjusts the operating speed of the pump and blower. Speed options range from SP6 (high) to SP1 (low). Adjusts the intensity of the underwater light. Light intensity ranges from Lt6 (high) to Lt1 (low). 	<ul style="list-style-type: none"> Included with all models. Available only for models with an underwater light.

fig. 9f

Setting the Water Temperature Display Unit Preferences

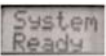
Note: By default, the water temperature is displayed in units (°F or °C) typical of your area. Setting the Water Temperature Display Unit Preference is optional, but if you wish to, you must do so after filling the bath with an adequate amount of water, but before setting any other controls. The Water Temperature Display Unit Preference only has to be set once, as it is permanently stored in the controller’s memory.

1. Observe the LCD and press and hold the On/Off button. Continue to press and hold the button (for about 10 to 15 seconds) while the LCD cycles through the available Timer settings and until it eventually displays an alternately flashing "Degree F" (Fahrenheit) and "Degree C" (Celsius).
2. Release the On/Off button when either the "°C" or "°F" is displayed, depending on your preference.

Turning the Bath Lighting On and Setting the Lighting Options

Note: You can turn on the bath lighting and set the lighting options before or after setting the Timer. The light operation time is independent of the Timer setting. Once set, the lighting will operate for 30 minutes; however, when the controller no longer detects water in the bath, the light operation is automatically reset to 30 minutes.

1. Observe the LCD and press the Select button. "Light Off" appears on the LCD.
2. Use the On/Off button to turn the jetted bath lighting on.
3. Use the Up and Down buttons to increase or decrease the intensity of the lighting, respectively. The light intensity ranges between Lt6 (high) and Lt1 (low). By default, the light intensity is set to the highest intensity (Lt6). Press and hold the Up and Down buttons to cycle to the higher or lower intensity settings.
4. Release the Up or Down button when the LCD displays your desired selection.

Setting the Timer

Note: You must set the Timer before you can operate the blower.

1. Observe the LCD and press and hold the On/Off button. Continue to press and hold the button while the LCD cycles through the available Timer settings: 20, 25 or 30 minutes.
2. Release the control when the number of minutes you would like the Timer to run is displayed on the LCD. The LCD alternately flashes the elapsed Timer run time and the water temperature (when water is present in the bath).

Starting the Variable-Speed Pump or Blower, Adjusting Operating Speed and Activating the Massage Option

Note: A variable-speed pump or blower operates at six speeds ranging between Sp6 (high) and Sp1 (low).

1. Observe the LCD and alternately press and release or hold the Select button until the LCD displays the pump or blower identifier. The pump or blower identifier as well as its operating state appears on the LCD, as follows:
Blower Off.
2. To start the pump or blower, observe the LCD and press the On/Off button to set the operating state to On. The pump or blower starts at a default intermediate speed of SP3.
3. To adjust the operating speed of the pump or blower, observe the LCD then press and hold the Up or Down buttons to increase or decrease the speed, respectively.
4. To activate the Massage option, observe the LCD and alternately press and release or hold the Select button until the LCD displays the pump or blower identifier. Press the Massage button. The pump or blower identifier as well as the operating state "Pulse" appears on the LCD. It is not necessary to first set the pump or blower operating state to On before activating the Massage option. You can simply press the Massage button when the pump or blower is OFF and the pump or blower starts in Massage mode.

Pausing and Resuming Bath Operations

You can pause and resume the bath operations as follows (the underwater light, if present and operating, remains lit while the bath is in Pause Mode).

1. To pause bath operations, observe the LCD and press and hold the On/Off button until "Pause Mode" appears on the LCD.
2. To resume bath operations, press the On/Off button. "Resume Bath" appears briefly on the LCD.

Turning Off the Bath Controls

You turn off the light or pump and blower one at a time or all at once. To turn off the accessories one at a time:

1. Observe the LCD and alternately press and release or hold the Select button until the LCD displays the light, pump or blower identifier. The light, pump or blower identifier as well as its operating state appears on the LCD.
2. Press the On/Off button to set the operating state of the light, pump or blower to Off.

To turn off all the accessories, including the timer but excluding the light, at the same time:

1. Observe the LCD and press the On/Off button. All operating accessories except the light stop and "System Off" appears on the LCD.

HOW TO USE YOUR WHIRLPOOL BATH

Before taking your first bath, read and apply the "Important Safety Instructions" on Page 1.

WARNING

To reduce the risk of injury, do not permit children to use the whirlpool unless they are closely supervised at all times. Those requiring supervision for any reason, should never be allowed to use the whirlpool unattended. Persons under a doctor's care, pregnant women, persons with high blood pressure, heart disease, diabetes, or any serious illness, should not use a whirlpool without prior consultation with their physician. Never use a whirlpool while under the influence of any drugs or alcohol.

Do not use the whirlpool if protective cover is not installed on the suction intake. Keep foreign objects, including hair, away from the suction intake as they could block the intake or get caught in it. For comfort and safety, persons with long hair should tie their hair in a bun to keep it out of the water and away from the suction fitting. Never place your head below the surface of the water.

TIME TO RELAX

It's time to relax, unwind, daydream, meditate, etc. Taking a whirlpool should put no pressure on you. Lay back and relax while the effervescent whirlpool action works on your body and floats your cares away.

WATER TEMPERATURE

Warm to moderately hot water is ideal for a relaxing and comfortable whirlpool bath. That temperature is someplace between 100° F and 102° F. The maximum water temperature should never exceed 104° F. If you're interested in knowing the exact temperature of the water, a thermometer can be purchased at a pool and spa shop, or if your system uses the Smart-Touch control the LCD displays the temperature when the system is on. Try cooler water for an invigorating whirlpool.

Temperatures exceeding 104°F may induce hyperthermia. Hyperthermia occurs when the internal temperature of the body reaches a level several degrees above normal body temperature of 98.6° F. The effects of hyperthermia include; failure to perceive heat, failure to recognize the need to exit the whirlpool and unawareness of pending hazards.

FILLING THE TUB

When the tub is filled with water above the highest jet, step in and sit down before turning the whirlpool on. Do not fill over the air controls or bath waste handles. We recommend this procedure for two reasons. Some switching systems will not work unless the bather is in the whirlpool and the action of the water can alter your sense of touch and balance as your foot "seeks" the bottom of the tub.

TURNING ON THE WHIRLPOOL

Turn on the pump by pressing or touching your control as described previously on pages 6, 7 and 8. The pump can take, at times, a minute or two to prime and begin to circulate the water.

TUNING YOUR WHIRLPOOL FOR PERSONAL PLEASURE

The whirlpool may be set to your personal preferences. The air controls in the open position, turned fully clockwise, will provide a more vigorous water action. Turning them counter clockwise softens the effect. (see Air Volume Control on page 3, fig. 2). The Whirlpool Jets (page 3, fig. 1) are adjustable and changing their positions can effect the whirlpool action. Generally, when the nozzle is centered, the strongest whirlpool is created. Turning the nozzles downward and more towards the center of the whirlpool bath, slows down the action.

BATH ADDITIVES

A drop or two of a biodegradable liquid soap, such as Basic H by Shaklee is enjoyable in a whirlpool bath, but a drop too much will cover you with bubbles and overflow onto the floor. Most people enjoy having a few bubbles floating around them. **Pearl does not recommend using use oil based products because the oil will settle in the**

whirlpool system. (The oil can also create an environment conducive to bacterial growth.) However, if you choose to use oil based additives, you must clean the system as outlined on the following page immediately after use. Bath Shops have a variety of products usable in your whirlpool bath, that do not contain oil. They have many fragrances that can enhance your whirlpool pleasure. Epsom Salts can be used in your whirlpool, but there are other mineral salts available that can also help relieve aches and pains. If you do not have a Bath Shop in your neighborhood, ask your pharmacist or a consultant at a Cosmetics Center for these products. **Be sure that any items you select for your bathing pleasure do not contain OIL ADDITIVES!**

Enjoy your whirlpool...There is no finer whirlpool made than a Pearl Whirlpool...It is the only one that is patterned after those used in hospitals and athletic departments.

HINTS FROM PEARL

Apple cider vinegar can help relieve achy muscles or flaky, itchy skin. It will both relax and invigorate your body when one cup is added to your whirlpool bath. The odor from the vinegar will only remain a few minutes. You will feel squeaky clean. The vinegar is also helpful in keeping the whirlpool system clean.

Try this! Massage the soles of your feet, one at a time, directly in front of a jet, but not so close that the whirlpool stops activating. Reflexologists say that there are nerve endings on the bottom of your feet that affect every part of your body. And it feels great!!

The best time to trap that moisture in your skin is immediately after using the whirlpool. An inexpensive and very effective moisturizer is petroleum jelly. After bathing, while the body is still wet, rub in a little amount of the jelly. Continue wetting body until the jelly is spread evenly and does not appear greasy. Many exclusive health spas use this method. You will be surprised at how soft and smooth your skin feels. Remember, it will not stay greasy if you keep adding water.

How about a facial? This is a good time for it unless you are sharing your whirlpool. Eggs are readily available and have been acknowledged as skin beautifiers for centuries - for all types of skin. Beat an egg until frothy, apply to face and neck. It will draw out impurities and refine the pores as it dries. Egg yolk, lightly beaten with a fork, then smoothed on skin and allowed to dry, is a comfortably gentle skin firmer for dry or normal skin.

USER MAINTENANCE INSTRUCTIONS

CLEANING THE TUB SURFACE

Proper care and maintenance will preserve the high gloss acrylic finish.

1. To properly clean the surface, wipe with a soft damp cloth, or sponge, using household soap or liquid detergent. The acrylic manufacturer recommends New Liquid Spic and Span for cleaning.
2. DO NOT use any cleaning products containing abrasives or solvents since these could dull the brilliant surface. HARSH CHEMICALS SHOULD NOT BE USED ON THE SURFACE.
3. The jets can be removed for cleaning. Use wrench provided with the tub. Do not remove the protective cover on the suction return for cleaning. The only time the protective cover is removed is to replace the decorative ring.
4. Alcohol may be used to remove glue, adhesives, etc. from the surface.

COMMERCIAL INSTALLATION (CLEANING)

In commercial installations, call Technical Service at (800) 851-5375 or (763) 424-3335 for specific cleaning instructions.

CLEANING THE PUMP AND PLUMBING SYSTEM

After the tub is installed and ready to use, remove all construction debris and clean the tub and pump system. Clean the the pump and plumbing system before the first use and every month thereafter, regardless of utilization. This is easily done as follows:

1. Set air control knobs to the closed position (turn counter clockwise).
2. Using hot water only, fill the tub to at least 2 inches above the highest jet.
3. Add 2 tablespoons of low sudsing automatic dishwasher detergent such as Calgonite or Cascade. Every other month use 1/2 cup of household bleach for cleaning the system.
4. Operate whirlpool for 20 minutes.
5. When the pump system stops, drain the water from the tub.

CAUTION Caustic drain openers will damage the surface and the pump. Should you experience a clogged drain, call a plumber to remove the trap for cleaning. Extreme heat from portable heaters and cigarettes can damage the surface of the tub. **We do not recommend the use of oil based bath additives.** Epsom salts or other mineral salts may be used in the tub.

MINOR SCRATCHES AND SCUFFS

The procedure to remove light surface scratch or burnish marks is quite simple. Apply automobile rubbing compound and lightly buff, then apply paste wax and lightly buff again. This will return the original shine.

MAJOR REPAIRS TO THE SURFACE

Should a deep scratch or more serious damage occur, please call your installation professional.

JET HARDWARE WRENCH

The wrench that is included with your tub is used to remove hardware for cleaning, replacing or adjusting the nozzle. Refer to the diagrams below for how to use this wrench. Again, use no abrasive cleaners. Use mild detergent and a soft cloth or sponge when cleaning. **Do not remove the cover on the suction return.** This cover is removed only when replacing the decorative ring (fig. 10).

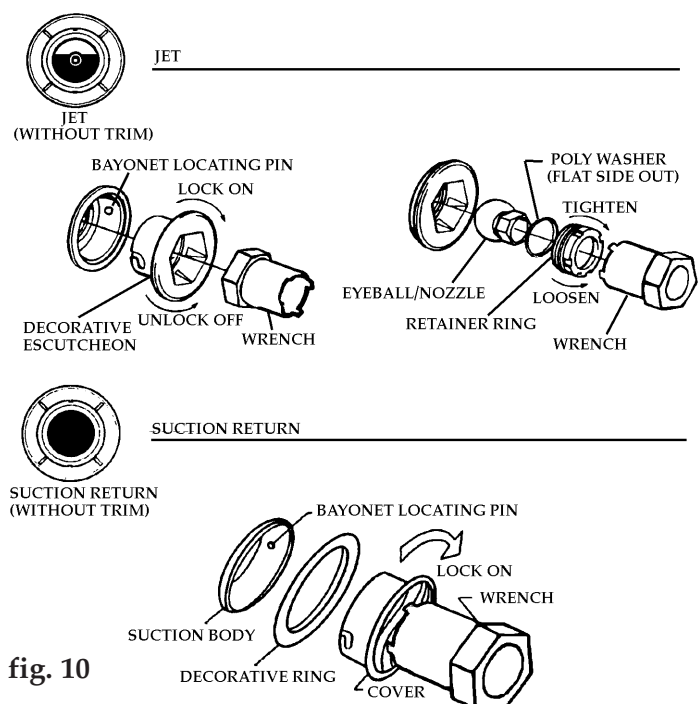

fig. 10

TROUBLE SHOOTING GUIDE

SYMPTOM

The whirlpool will not turn on.

CAUSE

- No power to the pump.
- Water level too low.

REMEDY

- Check the power to the GFCI circuit breaker for the pump.
- Add water until the level sensor is covered as in fig. 9d on page 6.

The whirlpool has a Smart-Touch control and LOW WATER flashes on the digital display.

- The water level is too low.

- Add water until the Pearl logo on the control illuminates.

The pump surges.

- The suction screen may be clogged.
- The impeller may be clogged.
- Jet nozzle is pointing at return.

- Inspect suction screen for hair or other debris.
- Adjust jet nozzle direction.

The pump comes on but does not move any water.

- Priming.

- It takes about two or three minutes for the pump to prime.

The pump moves water but at low pressure or loud noise.

- Air controls are not open.
- The suction screen is clogged.
- Impeller is clogged on pump.

- Open air controls as desired.
- Inspect suction screen for any debris, clean.
- Inspect pump for debris and clean.

The whirlpool system leaks.

- Damage in shipping, or other improper handling.

- Contact Technical Service for help.

The bath water drains very slowly.

- Bath waste plug is set too low.

- Remove bath waste plug and adjust the height by backing out and tightening the lock nut as in the set screw fig. 8 page 8.

The bath waste will not stay open while draining.

- Contact Technical Service for help.

The mood lights will not turn on.

- No power to the lights.
- Burned out or broken bulbs.

- Check the power to the GFCI circuit breaker for the lights.
- Remove the clear light cover and replace bulbs. Refer to page 6 mood lights.

The in-line heater does not heat sufficiently.

- No power to the heater.

- Check the power to the GFCI circuit breaker for the heater.

NOTE: IF ABOVE TROUBLE SHOOTING GUIDE IS INEFFECTIVE, CALL OUR TECHNICAL SERVICE AT (800) 851-5375 OR (763) 424-3335. PLEASE HAVE THE FOLLOWING INFORMATION READY FOR THE SERVICE TECHNICIAN:

- Name, address, and telephone number of the person we can contact to set up an appointment.
- The model and serial number of your whirlpool. You will find this information on the cover of the Owners Manual.
- Have a complete description of the problem to aid the technician in his determination how best to solve the problem.

REMEMBER: An in-line heater is designed to maintain water temperature, not to substitute for a water heater. It is common for the heater indicator light to fluctuate on and off in normal operation.

SALES TERMS AND CONDITIONS

Price Orders are accepted subject to prices in effect at the time of shipment and prices are subject to change without notice. The published pricing schedule shows suggested list prices and is subject to a trade discount as determined by MAAX Inc. (hereafter "MAAX").

Orders will be invoiced at the price in effect at the time the orders are placed. Selling prices may be readjusted without notice during the year, for instance if transportation costs increase due to fuel surcharges.

Conditions of acceptance The acceptance, shipment or delivery of any order is conditional upon approval of MAAX's credit department and upon these sales terms and conditions applying to the order and not any others, unless specifically agreed to in writing by MAAX. MAAX reserves the right to require satisfactory security for performance of the buyer's obligations prior to making shipment on any order. Any sold merchandise remains the property of the seller until full payment is received.

Terms of payment General payment terms are net 30 days. A rate of 2% monthly (26.82% per annum, compounded monthly) will apply on overdue accounts. No goods will be delivered to customers not complying with our sales and payment conditions.

Taxes All prices published are exclusive of applicable taxes.

Lost merchandise If, upon receipt, the recipient notices that certain products are missing, he must immediately notify our customer service department. The recipient must then indicate which products are missing on the delivery slip and countersign it. The enclosed bill of lading allows you to verify shipped and received merchandise.

Shipping damage Damage occurring in transit is the responsibility of the carrier. MAAX will not be held responsible for shipping damage. The product should be carefully examined by the user or installer at time of receipt to ensure it is damage free. If any damage is discovered, it should be noted on the freight bill, and a claim should be filed against the carrier as soon as possible.

Inspection of the unit prior to installation is the responsibility of the installer or building contractor who acts on behalf of the user, or the user himself. They are responsible for ensuring that the unit is free of defect or damage. In the event of a problem, the unit must not be installed. MAAX is not responsible for failures, costs, damages or claims that could have been discovered, repaired or avoided by proper inspection and testing prior to installation.

Returns Merchandise cannot be returned for any reason without written authorization from our customer service department. Any returned merchandise shall be liable to a 25% restocking fee and, if necessary, labor costs. MAAX will not accept the return of a non-custom product or a product that is not white, either with or without a basic massage system. All transportation fees shall be paid by the originator.

Color variations MAAX shall not be responsible for variations in granite color, wood grain, or color shades in the natural wood used; or for slight differences in color or texture of the material delivered in relation to the sample shown or provided to the purchaser. The purchaser may not use such differences to obtain a price discount or to cancel the order.

Cancellation The client may not cancel an order after 24 hours from receipt of MAAX's confirmation. All cancellation requests must be made by fax and be confirmed by MAAX.

Design and dimensions

MAAX reserves the right to discontinue products at any time or change specifications and/or design without notice and without incurring obligation. All dimensions are approximate and subject to change without prior notice.

Maintenance

Regular disinfections provide an effective defense against various types of bacteria susceptible of developing in the deposits that build up over time in all bathtubs and showers.

For daily maintenance cleaning, use a moist cloth and gentle liquid detergent.

For acrylic surfaces, occasional use of a special acrylic surface cleaner such as Lumashine or Lumacream will add luster and protect the finish.

Do not use abrasive cleaners, scrapers, metal brushes, or any items or products that could scratch or dull the surface.

To clean whirlpool piping, prevent residue build-up and extend the life and performance of whirlpool tubs, we recommend Mister MAAX[™] cleaner, available from all MAAX dealers. When used monthly, Mister MAAX[™] is considered an effective disinfectant to clean whirlpool and jet air circulation systems.

If you have any maintenance-related problems, MAAX representatives will answer your questions and recommend the best solutions.

Limited warranty

MAAX offers the following express limited warranty on each of its products. This warranty extends only to the original owner/end-user for personal household use. For commercial uses, additional limitations apply.

MAAX warrants **acrylic** units to be free from defects in workmanship and materials under normal use and service for a period of twenty (20) years (Designer and Essence) or ten (10) years (Classic) from the initial date of purchase by the owner/end-user, contractor or builder from an authorized dealer.

MAAX warrants **fiberglass** units to be free from defects in workmanship and materials under normal use and service for a period of three (3) years from the initial date of purchase by the owner/end-user, contractor or builder from an authorized dealer.

MAAX warrants **ABS** to be free from defects in workmanship and materials under normal use and service for a period of two (2) years from the initial date of purchase by the owner/end-user, contractor or builder from an authorized dealer.

MAAX warrants **polystyrene shower kits, tub wall kits, utility tubs and accessories** to be free from defects in workmanship and materials under normal use and service for a period of one (1) year from the initial date of purchase by the owner/end-user, contractor or builder from an authorized dealer.

MAAX warrants **whirlpool motor/pumps** to be free from defects in workmanship and materials under normal use and service for a period of five (5) years from the initial date of purchase by the owner/end-user, contractor or builder from an authorized dealer.

MAAX warrants **blowers** to be free from defects in workmanship and materials under normal use and service for a period of five (5) years from the initial date of purchase by the owner/end-user, contractor or builder from an authorized dealer.

MAAX warrants **whirlpool and other bathtub systems** to be free from defects in workmanship and materials under normal use and service for a period of two (2) years from the initial date of purchase by the owner/end-user, contractor or builder from an authorized dealer.

MAAX warrants **mirrors and electrical components** to be free from defects in workmanship and materials under normal use and service for a period of two (2) years from the initial date of purchase by the owner/end-user, contractor or builder from an authorized dealer.

MAAX warrants **shower doors** (with the exception of model 137795) to be free from defects in workmanship and materials under normal use and service for a period of ten (10) years from the initial date of purchase by the owner/end-user, contractor or builder from an authorized dealer.

MAAX warrants the **ceramic cartridges** for faucets against any leak resulting from normal use by the owner/end-user, contractor or builder for a limited lifetime.

MAAX warrants the **thermostatic cartridges** to be free from defects in workmanship and materials under normal use and service for a period of five (5) years from the initial date of purchase by the owner/end-user, contractor or builder from an authorized dealer.

MAAX warrants **shower massage systems** to be free from defects in workmanship and materials under normal use and service for a period of two (2) years from the initial date of purchase.

chase by the owner/end-user, contractor or builder from an authorized dealer.

MAAX warrants **Steamax systems** to be free from defects in workmanship and materials under normal use and service for a period of five (5) years, and **steam nozzles** for two (2) years, from the initial date of purchase by the owner/end-user, contractor or builder from an authorized dealer.

MAAX warrants **faucet finishes** to be free from defects in workmanship and materials under normal use and service by the owner/end-user, contractor or builder.

MAAX offers a lifetime warranty on its Chrome, Polished Brass and Brushed Nickel finishes.

MAAX warrants **medicine cabinets** to be free from defects in workmanship and materials under normal use and service for a period of ten (10) years from the initial date of purchase by the owner/end-user, contractor or builder from an authorized dealer.

Any product reported to the authorized dealer or to MAAX as being defective within the warranty period will be repaired or replaced (with a product of equal value) at the option of MAAX. This warranty extends to the original owner/end-user and is not transferable to a subsequent owner.

Neither the distributor, authorized MAAX dealer nor any other person has been authorized to make any affirmation, representation or warranty other than those contained in this warranty; any affirmation, representation or warranty other than those contained in this warranty shall not be enforceable against MAAX or any other person.

MAAX reserves the right to modify this warranty at any time, it being understood that such modification will not alter the warranty conditions applicable at the time of the sale of the products in question.

EFFECTIVE JANUARY 1, 2004

Limitations

This warranty shall not apply following incorrect operating procedures, breakage or damages caused by fault, carelessness, abuse, misuse, misapplication, improper maintenance, alteration or modification of the unit, as well as chemical or natural corrosion, accident, fire, flood, act of God or any other casualty.

The owner/end-user of the product covered by the present warranty is entirely responsible for its proper installation and electrical wiring. MAAX neither installs nor supervises the installation, nor hires a contractor for this purpose, and consequently cannot be held responsible for any default, breakage or damages caused thereby or resulting thereof, either directly or indirectly. The owner/end-user must provide access to the components of the product as described in the installation guide, so that MAAX can execute the warranty specified herein. If such access is not available, all expenses to provide said access will be the responsibility of the owner/end-user.

This warranty does not apply to products or equipment not installed or operated in accordance with instructions supplied by MAAX and all applicable rules, regulations and legislation pertaining to such installations.

MAAX strongly recommends that its products—for example, but without limitation, shower doors and other items—be installed by professionals with experience in bathroom products. Installation of shower doors by an inexperienced person may result in glass breakage and, consequently, cause personal injury or death.

MAAX is not liable for any costs, damages or claims resulting from the purchase of products that do not fit through openings or existing structures. MAAX is not liable for any costs, damages or claims resulting from defects that could have been discovered, repaired or avoided by inspection and testing prior to installation.

MAAX is not liable for personal injuries or death to any person or for any direct, special, incidental or consequential damage, loss of time, loss of profits, inconvenience, incidental expenses, labor or material charges, or any other costs resulting from the use of the product or equipment or pertaining to the application of the present warranty, or resulting from the removal or replacement of any product or element or part covered by this warranty.

EXCEPT AS OTHERWISE PROVIDED ABOVE, MAAX MAKES NO WARRANTIES, EXPRESS OR IMPLIED, INCLUDING WARRANTIES OF MERCHANTABILITY AND FITNESS FOR A PARTICULAR PURPOSE OR COMPLIANCE WITH ANY CODE.

In any case, MAAX cannot be liable for any amount over and above the purchase price paid for the product by the owner/end-user, contractor or builder.

Commercial Limitations

In addition to the above conditions and limitations, the warranty period for products installed for commercial applications or used in commercial ventures is of one (1) year from the initial date of purchase by the owner/end-user, contractor or builder from an authorized dealer. MAAX is not responsible for loss of use or profit under any circumstances. If the product is used as a display, the warranty period begins when the product is placed on display.

This warranty gives the owner/end-user specific legal rights. The owner/end-user may also have other rights which vary from one state and/or province to another.

Warranty service

In order to obtain service provided under this warranty during regular business hours, contact the dealer or distributor who sold the unit, or MAAX directly.

MAAX will provide the warranty service described above when the following conditions have been met: the failure is of the nature or type covered by the warranty; the user has informed an authorized MAAX Agent or Warranty Service Department representative of the nature of the problem during the warranty period; conclusive evidence (e.g., proof of purchase or installation) is provided to the foregoing by the user proving that the failure occurred or was discovered within the warranty period; an authorized independent service person or company representative has been permitted to inspect the product during regular business hours within a reasonable time after the problem was reported by the user.

MAAX's warranty obligation shall be discharged upon tender of replacement or repair. The customer's refusal to accept the tender terminates MAAX's warranty obligation.

MAAX products are certified by one or more of the following certification agencies:

- CSA
- UL
- IAPMO
- ULI
- INTERTEK (ETL)
- WARNOCK HERSEY
- US TESTING
- NAHB



Certain models are pending approval.

Certification may be ended by MAAX or certification agencies without notice.

NOTICE INSTALLER:

Underwriters Laboratories and some state agencies require that this Owner's Manual be left with the home owner or with the tub after installation.

Important safety instructions, warranty information and the product registration card are contained within.

***TAPE THIS PACKET TO
THE TUB OR LEAVE IN
AN OBVIOUS PLACE***

Manufactured by:



Pearl Baths, Inc.
9224 73rd Avenue North
Minneapolis, MN 55428
Phone: (763) 424-3335
Toll Free: (800) 328-2531
Fax: (763) 424-9808

www.pearlbaths.com
www.maax.com