

Panasonic®

Hybrid IP-PBX

User Guide for KX-TD7896

KX-TAW848/KX-TDA50
Model KX-TDA100/KX-TDA200



This manual is designed to be used with the KX-TD7896 Wireless PT (Wireless Proprietary Telephone) and a Panasonic KX-TAW/TDA series PBX (Business Telephone System).

Please read this guide before using and save for future reference.

Please use only the battery provided and charge the battery for about 7 hours before using the handset for the first time.

Table of Contents

| | |
|---|-----------|
| Location of Controls | 3 |
| Before Operating the Handset | 5 |
| Unsupported PBX Features | 5 |
| Selecting the Display Language | 5 |
| Selecting the Fwd/DND Icon | 6 |
| Enabling the Outgoing Call Log | 6 |
| Entering the Standby Display Name | 7 |
| Entering the Names of the Flexible Keys | 7 |
| Adjusting the Ringer Volume | 8 |
| Adjusting the Vibrate Setting..... | 9 |
| Adjusting the Receiver/Speaker/Headset Volume | 9 |
| Handset Display | 10 |
| Icons | 10 |
| Soft Keys..... | 11 |
| Operation Outline | 12 |
| Operation for KX-TAW848/TDA50/100/200..... | 16 |
| Making Calls | 16 |
| Receiving Calls | 18 |
| When the Dialed Extension is Busy/No Answer..... | 19 |
| During a Conversation | 20 |
| Useful Features..... | 20 |
| Making Use of the Voice Mail Service..... | 22 |
| Using the Handset Phonebook | 23 |
| Handset Phonebook | 23 |
| Storing an Item in the Handset Phonebook | 23 |
| Entering Characters | 25 |
| Locking the Handset Phonebook | 27 |
| Deleting Stored Items | 28 |
| Deleting Stored Items in Handset Phonebook/Hot Key Dial/Outgoing Call Log/ Incoming Call Log | 28 |
| Setting the Handset and Base Unit | 29 |
| Setting the Handset and Base Unit..... | 29 |
| Troubleshooting and Error Messages | 35 |
| Troubleshooting | 35 |
| Error Messages..... | 37 |
| Important Information..... | 38 |
| Battery Information..... | 38 |

Location of Controls

◆ Handset

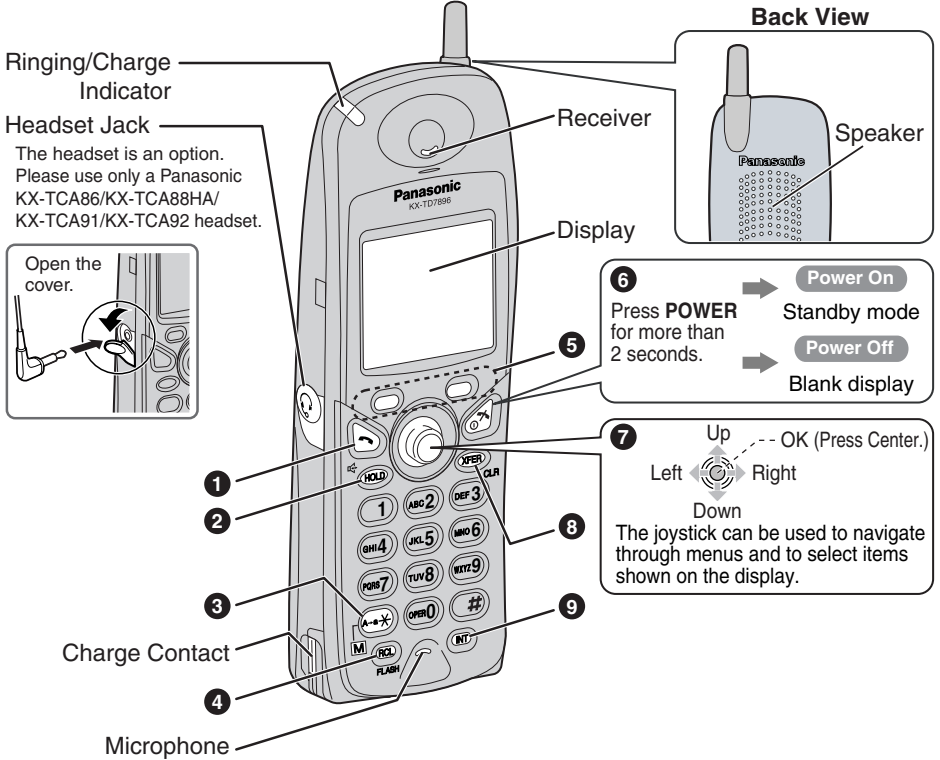

Location of Controls

1 TALK/SP-PHONE (Speakerphone) Key:
Used to make or answer calls, or toggle between the two conversation modes (Receiver/Hands-free*) during a conversation.

* You can talk with the other party alternately through the speaker without holding the handset.

2 HOLD Key:
Used to place a call on Hold.

3 Meeting Mode Key:
Used to turn Meeting Mode on or off when pressed for more than two seconds in standby mode.

4 RECALL/FLASH Key:
Used to disconnect the current call and make another call without hanging up, or answer a Call Waiting from the telephone company.

5 Left/Right Soft Key:
Used to select the function displayed directly above each key. Functions displayed depend on the state of use.

6 POWER/CANCEL Key:
Used to end calls, exit the Phonebook or Function mode, or turn the handset on or off.

7 Joystick:
Used to adjust the ringer/receiver volume, select the Function mode and the function displayed directly above it, and move the cursor to select a desired item.

8 TRANSFER/CLEAR Key:
Used to transfer a call to another party, or clear digits or characters.

9 INTERCOM Key:
Used to make or answer intercom calls.

◆ Key Lock
You can lock all keys other than the Joystick while the handset is in standby mode.

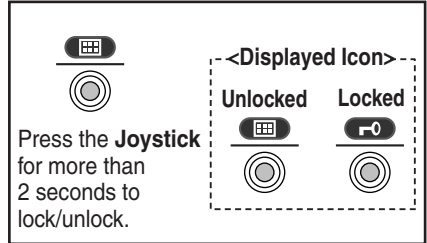

◆ Meeting Mode
You can set the handset to prevent incoming calls from ringing. This can be useful in situations where you do not want to be disturbed, for example during a meeting.

• During Meeting Mode, functions are:

| Function | Status |
|------------------------------|--------|
| Microphone volume | Up |
| Low battery alarm | Off |
| Key tone | Off |
| Ringer/Voice Call/Paging/LCS | Off |
| Ring On Charger | Off |
| Vibrate | On |

• During Meeting Mode or when Vibrate is set to Vib. & Ring and Vib. → Ring, while handset is on charger:

| Function | Status |
|----------|--------------|
| Vibrate* | Off |
| Ringer | User Setting |

* Please note that, if you set the handset on the charger while receiving an incoming call, vibration will stop. Once the vibration stops, the handset will not vibrate again for that call, even if the handset is lifted up again. (If Quick Answer is set, lifting up the handset will answer the call.)

Before Operating the Handset

◆◆ **Unsupported PBX Features**

The following PBX features are not supported when using a KX-TD7896:

- 1) **Background Music (BGM)**
- 2) **PBX System Programming**

◆◆ **Selecting the Display Language**

You can select the desired language (English/Spanish/French).

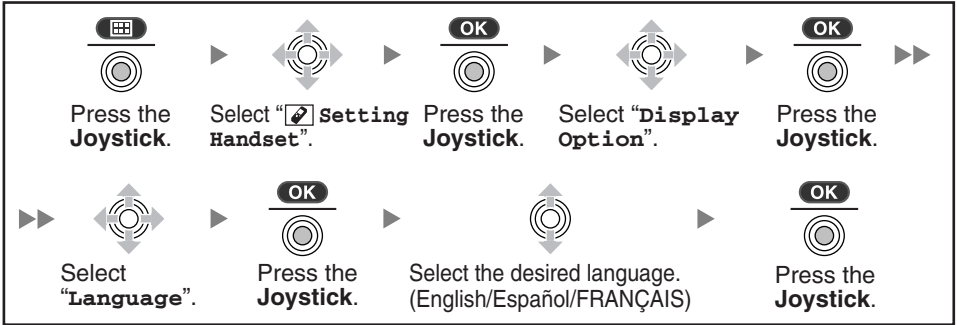

- The display language of both the handset and PBX can be selected, and both should be set to the same language. For more information, refer to the user documentation for your PBX.

Before Operating the Handset

◆◆ Selecting the Fwd/DND Icon

When the handset is connected to a KX-TAW848/KX-TDA series (KX-TDA50/100/200) PBX and the PT LED patterns for Fwd and DND have been set reversely on the PBX, you should change this setting to Mode 2.

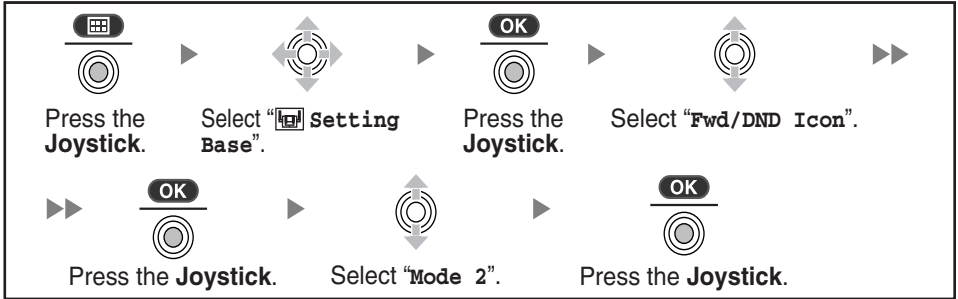

◆◆ Enabling the Outgoing Call Log

The default setting is "OFF" for the Outgoing Call Log. You can enable the Outgoing Call Log if needed.

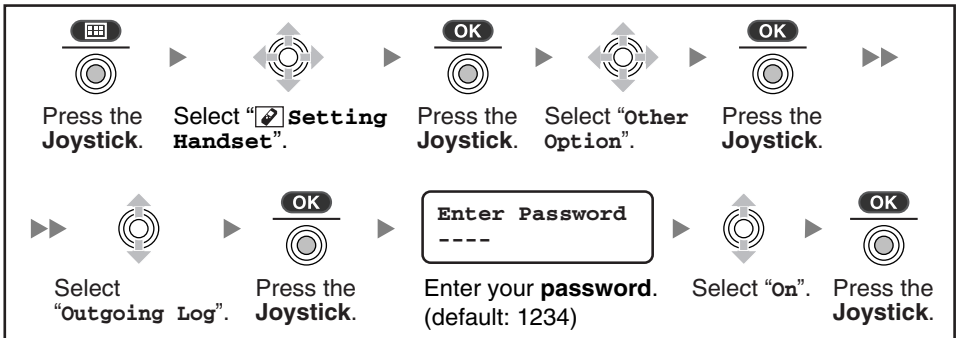

- Only the numbers you dial, or numbers dialed using Hot Key Dial or Phonebook will be stored in the Outgoing Call Log.

Before Operating the Handset

◆◆ Entering the Standby Display Name

You can enter the name of the standby mode display of the handset.

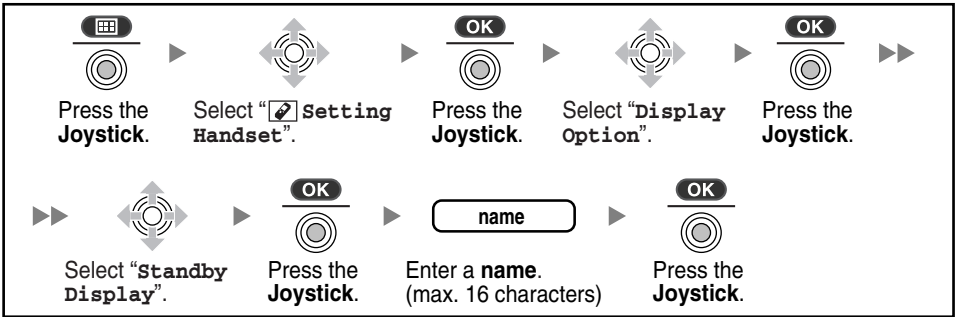

• To enter the name, see page 25.

◆◆ Entering the Names of the Flexible Keys

You can enter a name for each flexible key of the handset.

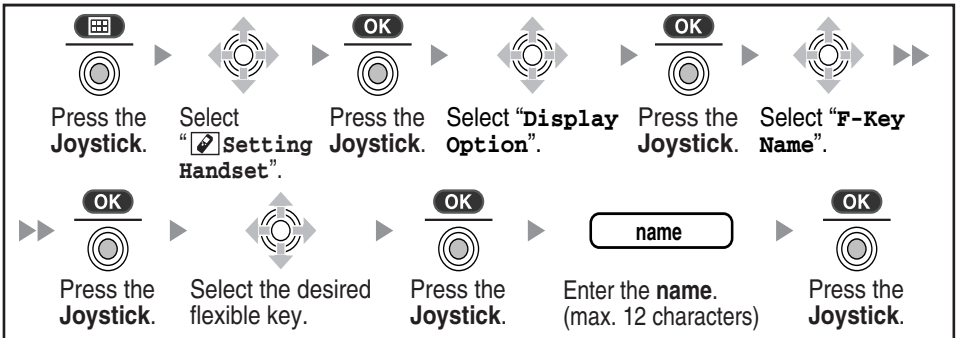

• To enter the name, see page 25.

Before Operating the Handset

◆◆ Adjusting the Ringer Volume

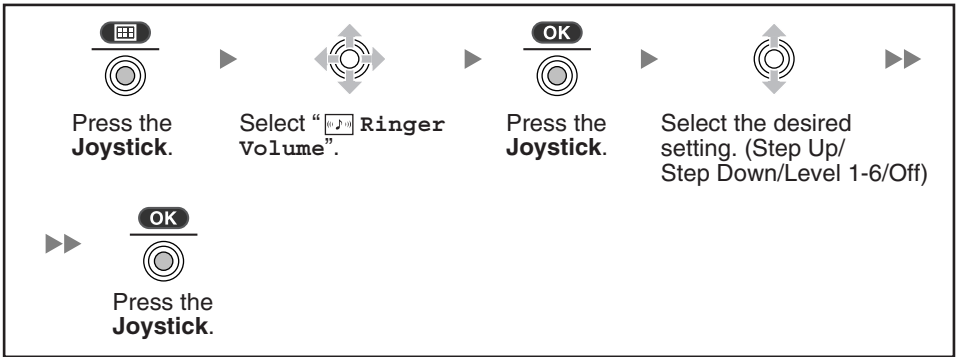

- For the ringer pattern, see page 31.

◆ Adjusting the Ringer Volume or Turning the Ringer Off While Ringing

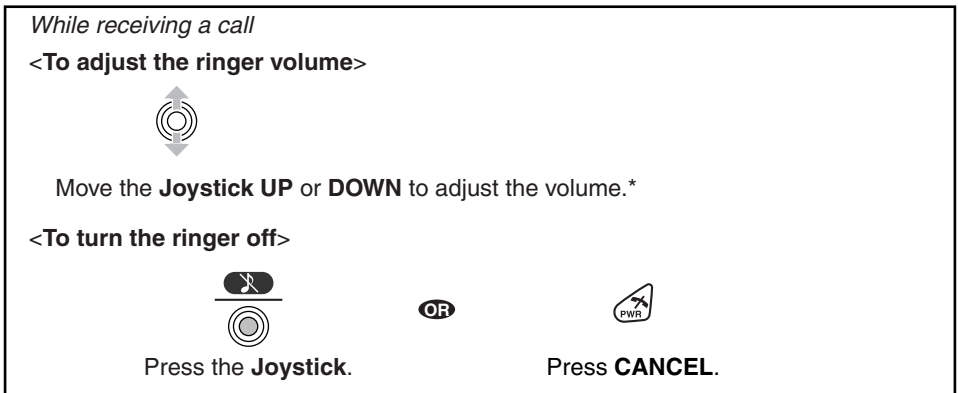

- * The adjusted volume level will also be used for subsequent calls.
- If you attach the headset while receiving an incoming call, the ring from the handset does not switch to the headset. If you attach the headset before receiving an incoming call, and headset tone is set to on, a tone will be heard from the headset. If Vibrate is set to on, the handset will vibrate whether a headset is attached or not.

Before Operating the Handset

◆◆ Adjusting the Vibrate Setting

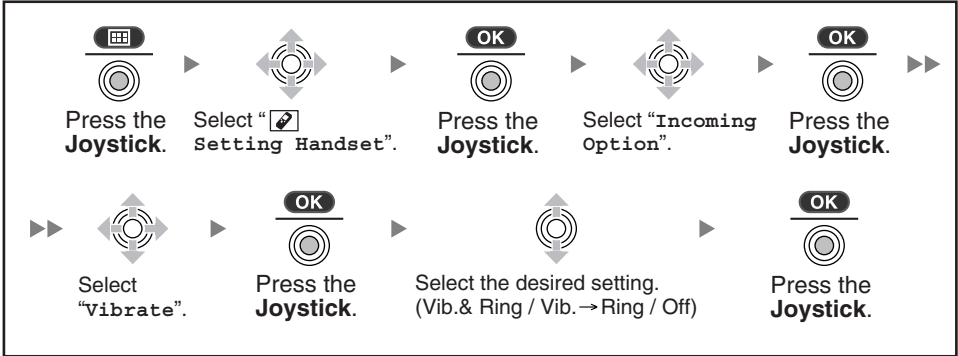

- You can receive an intercom call by the caller's voice instead of rings (**Voice Call**). For further information, refer to "Alternate Receiving—Ring/Voice" in the user documentation for your PBX.
- To set Vibrate only, without ringing, turn Meeting Mode on or set the Ringer Volume to off. (See page 8.)

◆◆ Adjusting the Receiver/Speaker/Headset Volume

During a conversation



Move the **Joystick UP** or **DOWN** to adjust the volume.

(Receiver Volume-Level 1-4, Speaker Volume-Level 1-6, Headset Volume-Level 1-4)

Handset Display

◆◆ Icons

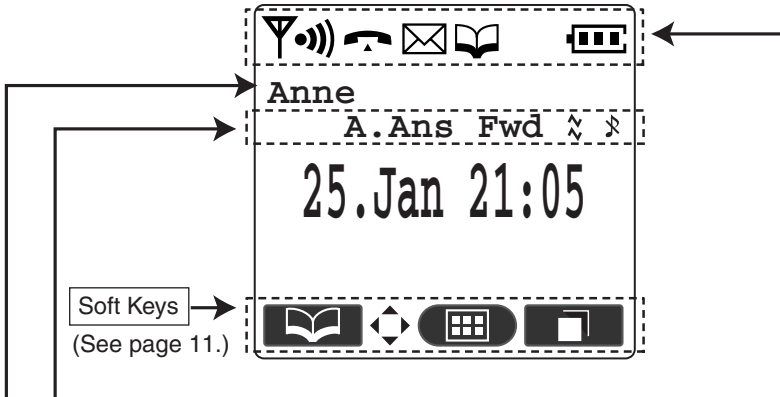

| | |
|---------------|---|
| | Ringer Volume OFF (See page 8.) |
| | Vibrate (See page 9.) |
| Fwd | Call Forwarding (See page 21.) |
| DND | Do Not Disturb (See page 21.) |
| A. Ans | Auto Answer (For Hands-free Answerback, see page 18.) |
| M | Meeting Mode (See page 4.) |





| | |
|--|---|
| | Within range of a base unit |
| | Out of range If this icon flashes when making a call, move closer to the base unit and dial again. |
| | Intercom Indicator |
| | Off-hook Status |
| | Message Waiting |
| | Phonebook |
| | Battery Indicator |

| | |
|--|--|
| <p><Standby Mode></p> <p>For "Entering the Standby Display Name", see on page 7.</p> | <p><While Off-hook/During a Conversation></p> <p>Talk Displayed during a conversation using the receiver.</p> <p>Speaker Phone Displayed during a conversation using the speaker (Hands-free mode).</p> <p>Headset Displayed when a headset is attached.</p> <p>Headset (SP) Displayed when a headset is attached during Hands-free mode.</p> <p> Mic Mute Flashes when Mic Mute is on.</p> |
|--|--|





◆◆ Soft Keys

Icons and information shown on the display will vary depending on the state of use. To select an item shown on the display, press the corresponding soft keys.



Handset Phonebook

-  Opens the Phonebook. Pressing this key for more than 2 seconds locks the Phonebook.
-  Displayed when in Phonebook Lock. Pressing this key then entering the password (default: 1234), unlocks the Phonebook temporarily. Pressing for more than 2 seconds, then entering the password (default: 1234), unlocks the Phonebook.
-  Stores a new item in the Phonebook.
-  Searches for an item in the Phonebook alphabetically.



Entering Characters

-  Displayed when in Alphabetic character entry mode. Pressing this key switches to Numeric character entry mode.
-  Displayed when in Numeric character entry mode. Pressing this key switches to Special character entry mode.
-  Displayed when in Special character entry mode. Pressing this key switches to Alphabetic character entry mode.
-  Inserts a dialing pause.
-  Clears digits or characters.











Sounds

-  Turns the microphone mute on or off during a conversation.
-  Turns the ringer off.

PBX Features

-  Establishes a multiple-party conversation (Conference).
-  Displayed when a phone number contains over 15 digits. Pressing these keys displays the rest of the phone number. Pressing while in PBX Personal programming mode, moves to the next or previous display.

Others

-  Opens the main menu. Pressing this key for more than 2 seconds locks all keys.
-  Returns to the previous display.
-  Opens the list menu (edit/delete in the Phonebook, etc.).
-  Confirms the entry.
-  Displayed when in Key Lock mode. Pressing this key for more than 2 seconds unlocks the keys.
-  Advances to the next display.
-  Displays the Outgoing Call Log.
-  Selects an item when in setting mode.
-  Displayed when there is no soft key icon.
-  Displayed when it is possible to use an arrow key to make a selection.

Handset Display

◆◆ Operation Outline

Handset functions are accessed through the display menu, and selected with the joystick and soft keys. The guidance display is shown in standby mode for easy operation.

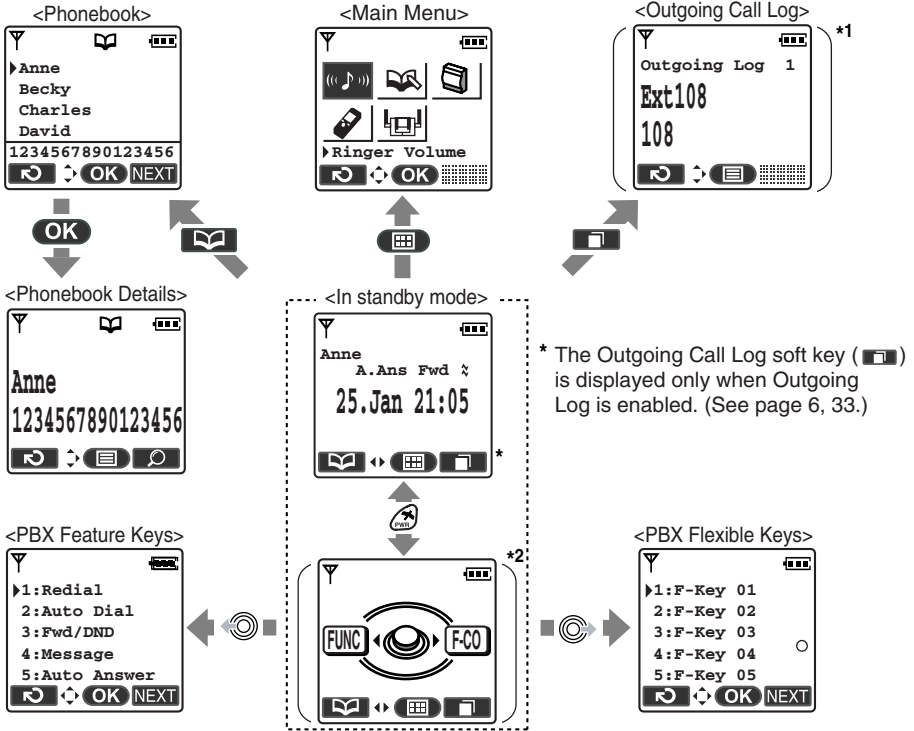

- These functions cannot be accessed while in key lock mode.
- The displays marked with [] are only shown when the following values have been set:
 - *1 Setting Handset → Other Option → Outgoing Log → On (See page 6, 33.)
 - *2 Setting Handset → Display Option → Guidance → On (See page 33.)

◆ Function Menus

Press the joystick to display the main and sub menus.

Main Menu—While in Standby Mode

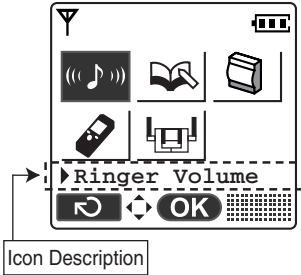

Ringer Volume:

Accesses the “Ringer Volume” setting.



New Phonebook:

Stores a new item in the Phonebook.



PBX Program:

Enters PBX Personal Programming mode. For PBX Personal Programming, refer to the user documentation for your PBX. Press  to exit from PBX Personal Programming mode.



Setting Handset:

Accesses the “Setting Handset” settings.



Setting Base:

Accesses the “Setting Base” settings.

Sub Menu—While Off-hook/During a Conversation



Phonebook:

Opens the Phonebook.



New Phonebook:

Stores a new item in the Phonebook.



Outgoing Call Log:

Enters the Outgoing Call Log.

*1 The Outgoing Call Log icon is displayed only when Outgoing Log is enabled. (See page 6, 12, 33.)

Handset Display

◆ PBX Feature Keys

Handset functions can be activated through the display key list. Move the joystick left to display the feature key list.

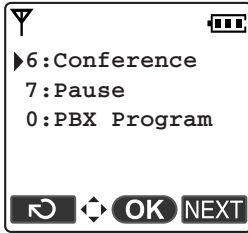
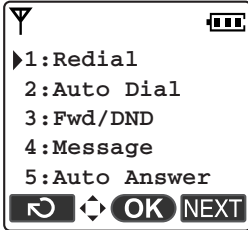

1:Redial:

Redials the last dialed number.

2:Auto Dial:

Makes a call through PBX Personal/System Speed Dialing.

3:Fwd/DND:

Displays and/or sets Call Forwarding or Do Not Disturb.

4:Message:

Leaves a message waiting indication, or calls back the party who left you a message waiting indication when ☒ is displayed.

5:Auto Answer:

Answers an incoming call automatically in hands-free mode. "A .Ans" is displayed in standby mode.

6:Conference:

Establishes a multiple-party conversation.

7:Pause*1:









Inserts a dialing pause.

0:PBX Program*2:

Enters PBX Personal Programming mode. Press  to exit from PBX Personal Programming mode.



- *1 Displayed only during a conversation or PBX Personal Programming mode.
- *2 Displayed only while in standby mode or PBX Personal Programming mode.
- For PBX Personal Programming, refer to the user documentation for your PBX.

| Combination Keys | | | |
|---|------------------|---|--------------------|
|  | Redial |  | Auto Answer |
|  | Auto Dial |  | Conference |
|  | Fwd/DND |  | Pause |
|  | Message |  | PBX Program |



- For operation, see page 16.

◆ PBX Flexible Keys

A flexible key can be used either to seize a line in order to make or receive an outside call (F-Key), or used as a function key. Move the Joystick right to display the flexible key list. Here you can access the 12 flexible keys. The icon shown beside each F-Key indicates line status similarly to the LED indicators on a PT: ● is the same as a green LED; ○ is the same as a red LED.



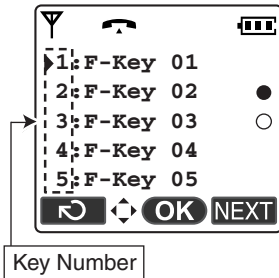

Example:



Understanding the F-Key Icons*











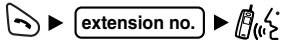
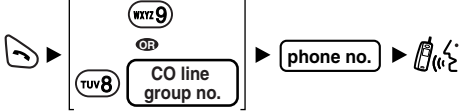
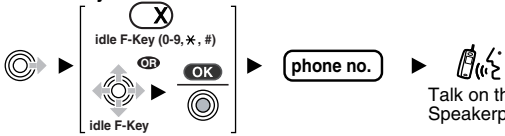

- (on): You are currently using this line.
- ⊙ (flashing rapidly): You have an incoming call on this line.
- ⊙ (flashing slowly): You have a call on hold on this line.
- (on): This line is in use by someone else.
- ⊙ (flashing rapidly): There is an incoming call on this line.
- ⊙ (flashing slowly): Someone has a call on hold on this line.
- (no icon): This line is idle.





- * The meanings of these icons vary depending on the status of the CO line.
- For further information, refer to “LED Indication” in the feature documentation for your PBX.
- To select a key, press its key number, or move the Joystick  to select the desired key then press  (hands-free mode) or  (receiver). For operation, see “Receiving—An Outside Call on a specific line” on page 18.
- To go to the next or previous display, move the Joystick .
- To go to the next display, press .









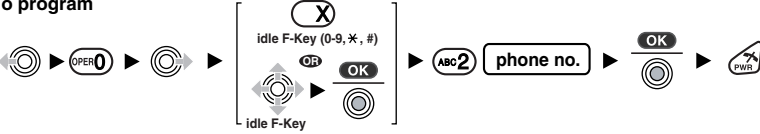

Operation for KX-TAW848/TDA50/100/200

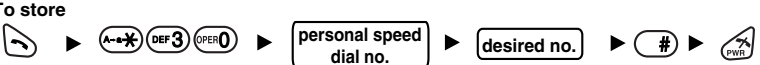
For further information, refer to the user documentation for your PBX or consult your dealer.

| Desired Function | Operation |
|---------------------|--|
| Making Calls | |
| Calling | <p>To an extension</p>  <p>To an external party</p>  |
| | <p>To use F-Keys</p>  <p>To use F-Keys (continued)</p>  |
| | <p>To use Hot Key Dial</p> <p> - Press the dialing key for more than 1 second.</p>  |
| | <p>To use the Outgoing Call Log^{*1}</p>  |
| | <p>To use the Phonebook</p>  <p><Direct Search> </p> <p> - Enter the first letter of the desired name. (0-9)</p> <p><Name Search> </p> <p>   </p> <p>To enter a character, press the corresponding dialing key repeatedly until the character is displayed.</p> |









- You can confirm a number was dialed correctly before calling (**Predialing**) by entering the number, then pressing .
- To clear an entire number while predialing, press  for more than 1 second.
- ^{*1} Only the numbers you dial, or numbers dialed using Hot Key Dial or Phonebook will be stored in the Outgoing Call Log. Note that, the Outgoing Log setting of your handset must be set to on for this feature to operate. (See page 6, 33.)
Any Password or Account Code you enter will also be stored in the Outgoing Call Log. Therefore, for security purposes please delete as necessary. (See page 28.)
- To store an item in the Phonebook or as a Hot Key, see page 23 or 24.

Operation for KX-TAW848/TDA50/100/200

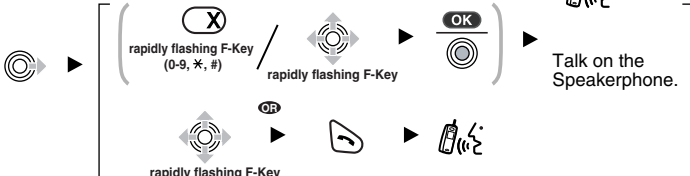
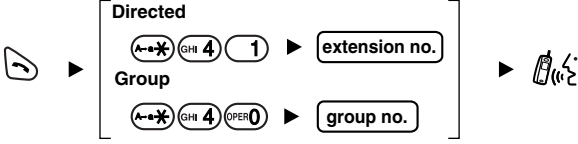
| Desired Function | Operation |
|---|---|
| Making Calls | |
| Redial* ¹ |  <p style="text-align: right;">Talk on the Speakerphone.</p> |
| One-touch Dialing | <p>To program</p>  <p>To dial</p>  |
| Calling an operator |  |
| Speed Dialing (Personal) | <p>To store</p>  <p>To dial</p>  |
| Speed Dialing (System) | <p>To dial</p>  |
| Calling back a caller using the Incoming Call Log | <p>To program</p>  <p>To dial</p>  <p>* Caller ID is displayed for about 5 seconds. If you press  during that time period, the display goes blank until the time expires. While Caller ID is displayed or the display is blank, you cannot receive a call, make a call using  or enter PBX Personal Programming mode. To return to the standby display, press  then press .</p> |































































































*¹ You can use the last number stored in the PBX to make calls (Last Number Redial). However, in this case the number will not be stored as a new entry in the Outgoing Call Log.

Operation for KX-TAW848/TDA50/100/200

| Desired Function | Operation | |
|---|--|--|
| Receiving Calls | | |
| Receiving | <p>An Intercom Call/An Outside Call</p>  | <p>An Intercom Call</p>  <p>Talk on the Speakerphone.</p> |
| | <p>An Outside Call on a specific line</p>  | |
| Picking up a call |  | |
| Hands-free Answerback (Auto Answer) | <p>An Intercom Call To set/cancel</p>  | |
| Live Call Screening* ¹ (LCS) | Hands-free mode | <p>To answer the call</p>  <p>To stop monitoring</p>  |
| | Private mode | <p>To start monitoring</p>  <p><i>While monitoring</i></p> <p>To answer the call</p>  <p>To stop monitoring</p>  |

*¹ This feature is available when the PBX is connected to a Panasonic Voice Processing System (VPS). For setting LCS, refer to the user documentation for your PBX.

Operation for KX-TAW848/TDA50/100/200

| Desired Function | Operation | | | | | | | | | | | | | | | | | | |
|--|---|---|--|--------------------------|--|--|---|--|--|--|--|--|---------------------------|--|--|---|--|--|--|
| When the Dialed Extension is Busy/No Answer | | | | | | | | | | | | | | | | | | | |
| Automatic Callback Busy | To set <i>While hearing a busy tone</i>  ►  | To answer <i>If you hear callback ringing</i>  ►  | | | | | | | | | | | | | | | | | |
| Message Waiting | Sender | To leave a notification <i>When the receiver's extension is busy or does not answer</i>  ►  ►  | | | | | | | | | | | | | | | | | |
| | Receiver | To cancel a notification  ►     ► receiver's extension no. ►  | | | | | | | | | | | | | | | | | |
| Call Waiting | Sender | <i>While hearing a busy tone</i>  ► Wait for an answer. ►  | | | | | | | | | | | | | | | | | |
| | Receiver | To set/cancel <table border="0" style="width: 100%; border-collapse: collapse;"> <tr> <td style="width: 10%;"></td> <td style="width: 80%; border-left: 1px solid black; border-right: 1px solid black; padding: 5px;"> For outside calls </td> <td style="width: 10%;"></td> </tr> <tr> <td></td> <td style="border-left: 1px solid black; border-right: 1px solid black; padding: 5px;">  ►      No tone </td> <td></td> </tr> <tr> <td></td> <td style="border-left: 1px solid black; border-right: 1px solid black; padding: 5px;">  ►      Tone </td> <td></td> </tr> <tr> <td></td> <td style="border-left: 1px solid black; border-right: 1px solid black; padding: 5px;"> For intercom calls </td> <td></td> </tr> <tr> <td></td> <td style="border-left: 1px solid black; border-right: 1px solid black; padding: 5px;">  ►      No call </td> <td></td> </tr> <tr> <td></td> <td style="border-left: 1px solid black; border-right: 1px solid black; padding: 5px;">  ►      Tone </td> <td></td> </tr> </table> | | For outside calls | | |  ►      No tone | | |  ►      Tone | | | For intercom calls | | |  ►      No call | | |  ►      Tone |
| | For outside calls | | | | | | | | | | | | | | | | | | |
| |  ►      No tone | | | | | | | | | | | | | | | | | | |
| |  ►      Tone | | | | | | | | | | | | | | | | | | |
| | For intercom calls | | | | | | | | | | | | | | | | | | |
| |  ►      No call | | | | | | | | | | | | | | | | | | |
| |  ►      Tone | | | | | | | | | | | | | | | | | | |
| | To talk to the new party (<i>While hearing the Call Waiting tone</i>) <p>To terminate a current status</p>  ►  ►  | | | | | | | | | | | | | | | | | | |
| | <p>To hold and then talk to the new party</p>  ►  ►  ►  ►  | | | | | | | | | | | | | | | | | | |

• Disregard this step if both parties are extensions.

Operation for KX-TAW848/TDA50/100/200

| Desired Function | Operation |
|------------------------------|--|
| During a Conversation | |
| Transferring a call*1 | <p>extension no. to an extension OK phone no. to an external party Announce.</p> |
| Holding a call*2 | <p>To hold</p> <p>To retrieve a call at the holding extension</p> <p>flashing F-Key (0-9, *, #) OR OK flashing F-Key OR INT</p> |
| | <p>To retrieve an outside call from another extension</p> <p>flashing F-Key (0-9, *, #) OR OK flashing F-Key</p> |
| Holding a call exclusively*2 | <p>To Hold</p> <p>• You can hold a call exclusively so that other people cannot retrieve the call.</p> <p>To retrieve a call on exclusive hold</p> <p>flashing F-Key (0-9, *, #) OR OK flashing F-Key OR INT</p> |
| Three-party conference | <p>third party's no.</p> |
| Useful Features | |
| Paging*3 | <p>To page Group</p> <p>group no. Announce.</p> |
| | <p>To answer an announced page Through a telephone speaker</p> <p>A-*, GHI 4, DEF 3</p> |

*1 To return to the call before the destination answers, press or , or select the corresponding F-Key.

*2 The method used to hold a call depends on the Call Hold mode (General Call/Exclusive Call Hold). Ask your manager what the current mode is.



When you hold several outside calls, you need to assign the F-Keys (Single-CO/Group-CO/Loop-CO) to a flexible key as necessary, beforehand.

*3 While making a paging announcement, battery consumption is the same as that of a normal conversation.

Operation for KX-TAW848/TDA50/100/200

| Desired Function | Operation |
|------------------------|---|
| Useful Features | |
| Setting Absent Message | ► ► message no. ► parameter (if required) ► ► |
| Clearing the setting | ► ► |
| Log-in/Log-out | ► Log-in ► Specified ► Log-out ► All ► * ICD Group: Incoming Call Distribution Group |
| Do Not Disturb (DND) | ► Both calls Outside calls Intercom calls ► Set Cancel ► |
| Call Forwarding (Fwd) | ► Both calls Outside calls Intercom calls ► ► * Enter your desired extension no., or line access code and outside phone no. To Voice Processing System (VPS) All calls Busy No Answer Busy/No Answer ► ► Cancel |
| Locking your extension | ► Lock ► extension PIN* Unlock ► * PIN: Personal Identification Number |

Operation for KX-TAW848/TDA50/100/200

| Desired Function | Operation | | | | | | | | | | | |
|---|--|---|--|--|----------------------|--|-------------|--|---------------------------------|--|---|--|
| Making Use of the Voice Mail Service | | | | | | | | | | | | |
| Listening to a message | From your own extension |  ► VPS extension no. ► ► VPS password* # • If you have no password, you can skip the last step. | | | | | | | | | | |
| | From someone else's extension |  ► VPS extension no. ► ► # MNO6 ► A-e* ► ► mailbox no. ► ► VPS password* # • If you have no password, you can skip the last step. | | | | | | | | | | |
| Leaving a message |  ► VPS extension no. ► ► VPS password* # ► ► # MNO6 ► A-e* ► mailbox no. ► VPS password* # ► ABC2 ► • If you have no password, you can skip the last step. ► # 1 ► Enter the first 3 or 4 letters of the desired name ► 1 1 ► Leave a message ► ► 1 ABC2 ► <table border="1" data-bbox="454 959 801 1102" style="margin-left: 20px;"> <tr> <td colspan="2" data-bbox="471 959 762 983">To send the message immediately</td> </tr> <tr> <td data-bbox="471 983 617 1007">1 ABC2</td> <td data-bbox="617 983 762 1007"><input type="checkbox"/> KX-TVA series</td> </tr> <tr> <td data-bbox="471 1007 617 1031">ABC2</td> <td data-bbox="617 1007 762 1031"><input type="checkbox"/> KX-TVS series</td> </tr> <tr> <td colspan="2" data-bbox="471 1031 762 1054">To set the delivery time</td> </tr> <tr> <td colspan="2" data-bbox="471 1054 762 1078">1 1 ► Follow the guidance</td> </tr> </table> | | To send the message immediately | | 1 ABC2 | <input type="checkbox"/> KX-TVA series | ABC2 | <input type="checkbox"/> KX-TVS series | To set the delivery time | | 1 1 ► Follow the guidance | |
| | To send the message immediately | | | | | | | | | | | |
| 1 ABC2 | <input type="checkbox"/> KX-TVA series | | | | | | | | | | | |
| ABC2 | <input type="checkbox"/> KX-TVS series | | | | | | | | | | | |
| To set the delivery time | | | | | | | | | | | | |
| 1 1 ► Follow the guidance | | | | | | | | | | | | |
| During playback | <input type="checkbox"/> OPER 0 Repeat Voice Guidance <input type="checkbox"/> A-e* Exit Menu | | | | | | | | | | | |

- KX-TVA series
 - 1** Listen to Message
 - ABC2** Deliver Message
 - DEF3** Mailbox Management
 - GHI4** Automated Attendant
 - JKL5** Message Notification
 - MNO6** Other Features
 - A-e*** End Call
- KX-TVS series
 - 1** Listen to Message
 - ABC2** Deliver Message
 - DEF3** Check Mailbox Distribution
 - GHI4** Automated Attendant
 - JKL5** Mailbox Management
 - MNO6** Other Features
 - A-e*** End Call

- * For more information on the VPS password, refer to the user documentation for the VPS.
- Some feature access numbers may vary depending on the market. Please consult your local dealer for the details.

◆◆ Handset Phonebook

You can store up to 200 items with names, phone numbers and category numbers in the handset for easy access. You can set unique Ringer/LED/Vibrate patterns for each category to identify incoming calls. All Phonebook items are stored in alphabetical order. For security purposes, you can lock the Phonebook. To make a call using the Phonebook, Outgoing Call Log or Hot Key Dial, see page 16.

◆ Incoming Call Identification (Private Ring)

You can organize entries in the Phonebook into one of 9 categories. A call from someone stored in one of these categories will be indicated by the ringer pattern, ringing indication (LED) color pattern and vibrate pattern assigned to the category ("Private Ring-Category 1-9").

| Item | Setting |
|-----------------|------------------------------------|
| Ringer pattern | 6 bells, 9 melodies (See page 31.) |
| LED pattern | 4 patterns (See page 31.) |
| Vibrate pattern | 7 patterns (See page 31.) |





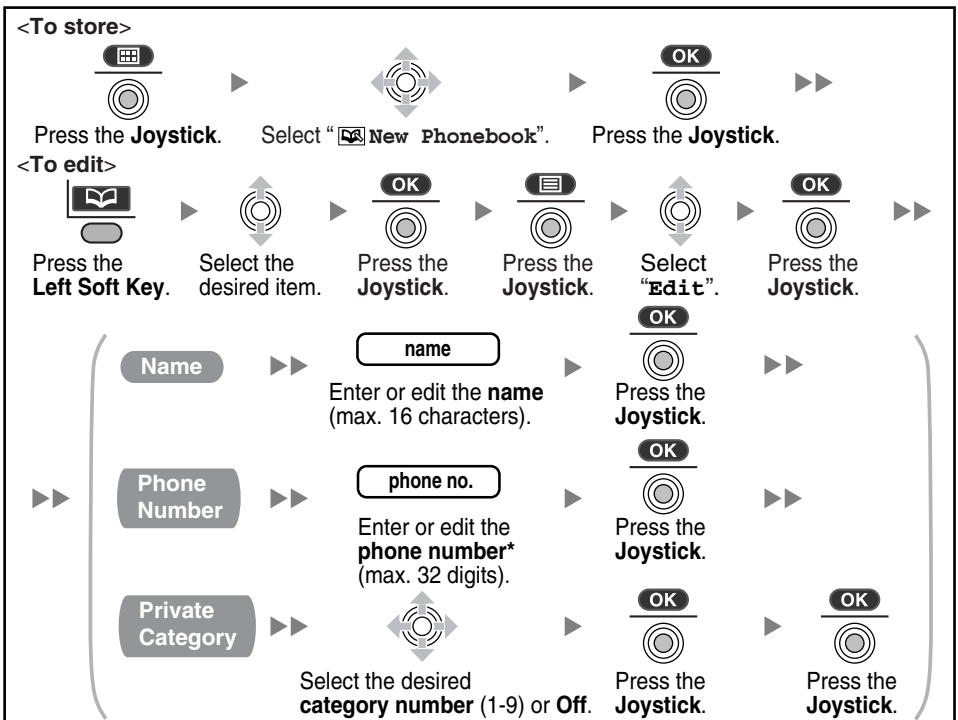

◆◆ Storing an Item in the Handset Phonebook

◆ Storing a New Item and Editing a Stored Item



Using the Handset Phonebook



- To enter characters, see page 25.
- * The valid digits are “0” through “9”, “*”, “#”, “P ()” and “F ()”.
- * Although up to 200 Phonebook items can be stored, each phone number stored in the Phonebook that contains over 24 digits counts as two Phonebook items.
- * If there is only one Phonebook memory location available left, you cannot store a phone number that is over 24 digits long.
- To change a character or digit, move the joystick  to highlight it, press  to delete it, then enter the new character or digit.
- To clear an entire line, press  for more than 1 second.
- To move the cursor to the left or right, move the joystick  or , respectively.

◆ Storing an Item Using the Outgoing Call Log

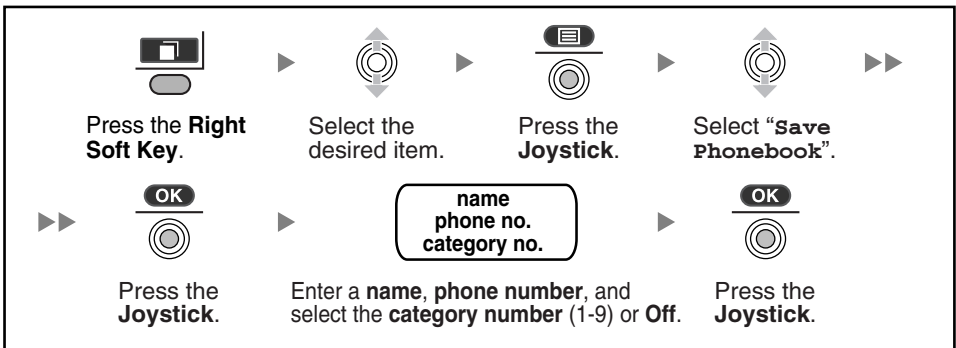

◆ Storing a Handset Phonebook Number as Hot Key Dial

A phone number stored in the Phonebook can be assigned as a Hot Key.

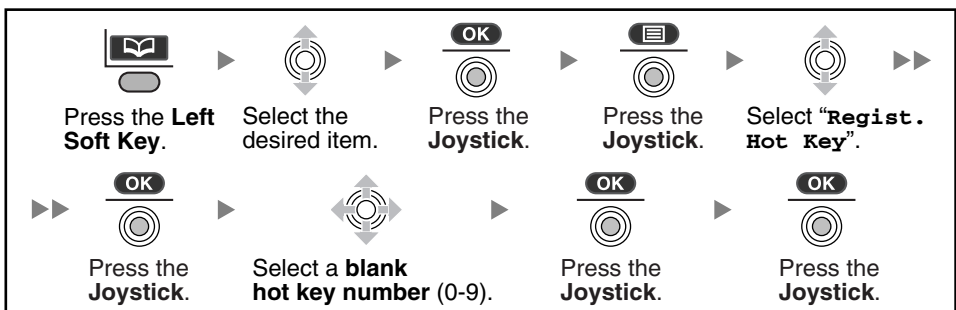

- A “√” will be displayed next to hot key numbers that have a Phonebook item registered to them.

◆◆ Entering Characters

You can enter characters and digits using the dialing keys.

You can select one of 3 character modes by pressing the **Right Soft Key** while entering a name. The function icon above the soft key displays the current character mode.

See “Character Mode Table” (page 26) for available characters.

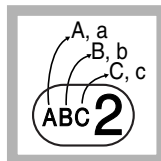

To change the character mode while editing a name in the Phonebook, press the **Right Soft Key**.

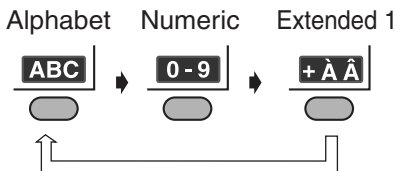

Example: To enter “Anne” in Alphabet Mode.

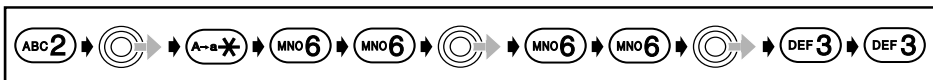

- To switch between uppercase and lowercase, press **A-a X**.
- To enter a character located on the same dialing key as the previous character, move the cursor by moving the Joystick **⊙**, then enter the desired character.
- If you enter a different character by mistake, move the Joystick **⊙** to highlight the character, press **XFER CLR** to delete it, then enter the correct character.
- To clear an entire line, press **XFER CLR** for more than 1 second.
- To move the cursor, move the Joystick **⊙**.

Using the Handset Phonebook

◆ Character Mode Table

| Keys | ABC (Alphabet) | 0-9 (Numeric) | +AA (Extended 1) |
|---------------|-----------------------------|---------------|-----------------------------|
| 1 | Space # & ' () * , - . / 1 | 1 | Space # & ' () * , - . / 1 |
| ABC 2 | ABC 2 | 2 | AÀÁÂÃÄÅÆBCÇ 2 |
| | abc 2 | | aàáâãäåæbcç 2 |
| DEF 3 | DEF 3 | 3 | DEÈÉÊËËËËF 3 |
| | def 3 | | deèéêëëëf 3 |
| GHI 4 | GHI 4 | 4 | GĞHIİİİİİİİİ 4 |
| | ghi 4 | | gğhiıııııııı 4 |
| JKL 5 | JKL 5 | 5 | JKL 5 |
| | jkI 5 | | jkI 5 |
| MNO 6 | MNO 6 | 6 | MNÑOOÓÔÕÖØ 6 |
| | mno 6 | | mñoòóôõöø 6 |
| PQRS 7 | PQRS 7 | 7 | PQRSŞß 7 |
| | pqr s 7 | | pqr sŞß 7 |
| TUV 8 | TUV 8 | 8 | TUÙÚÛÜÛÛV 8 |
| | tuv 8 | | tuùúúúüv 8 |
| WXYZ 9 | WXYZ 9 | 9 | WŴXYŷZ 9 |
| | wxyz 9 | | wŴxyŷz 9 |
| OPER 0 | Space 0 | 0 | Space 0 |

- Press **(↔*)** before or after entering a character to change between uppercase and lowercase.
- For example, to enter the letter “C”, press **(ABC 2)** three times.

Using the Handset Phonebook

◆◆ Locking the Handset Phonebook

You can lock/unlock the Phonebook while the handset is in standby mode.

◆ Locking the Handset Phonebook

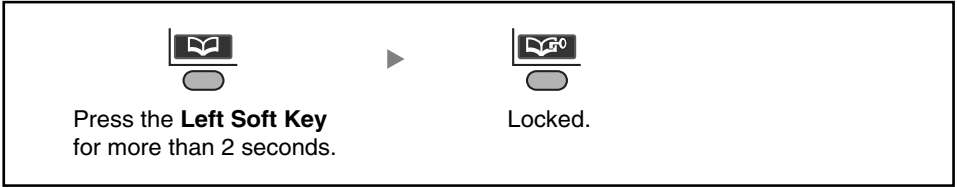

◆ Unlocking the Handset Phonebook

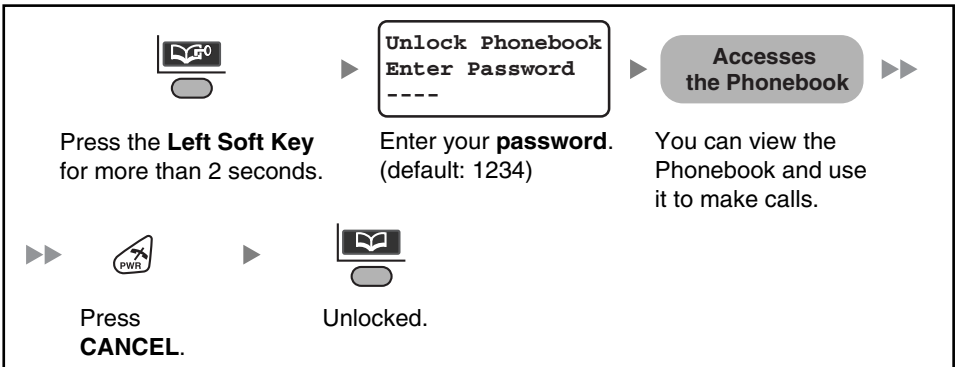

◆ Unlocking the Handset Phonebook Temporarily

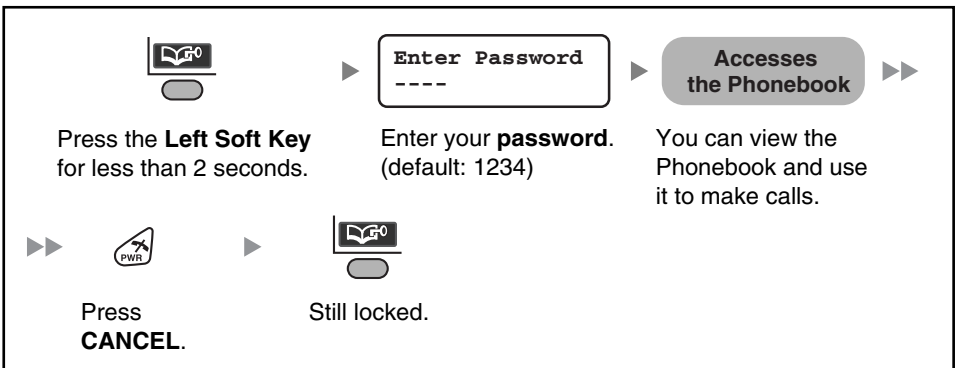

Deleting Stored Items

◆◆ Deleting Stored Items in Handset Phonebook/Hot Key Dial/Outgoing Call Log/Incoming Call Log

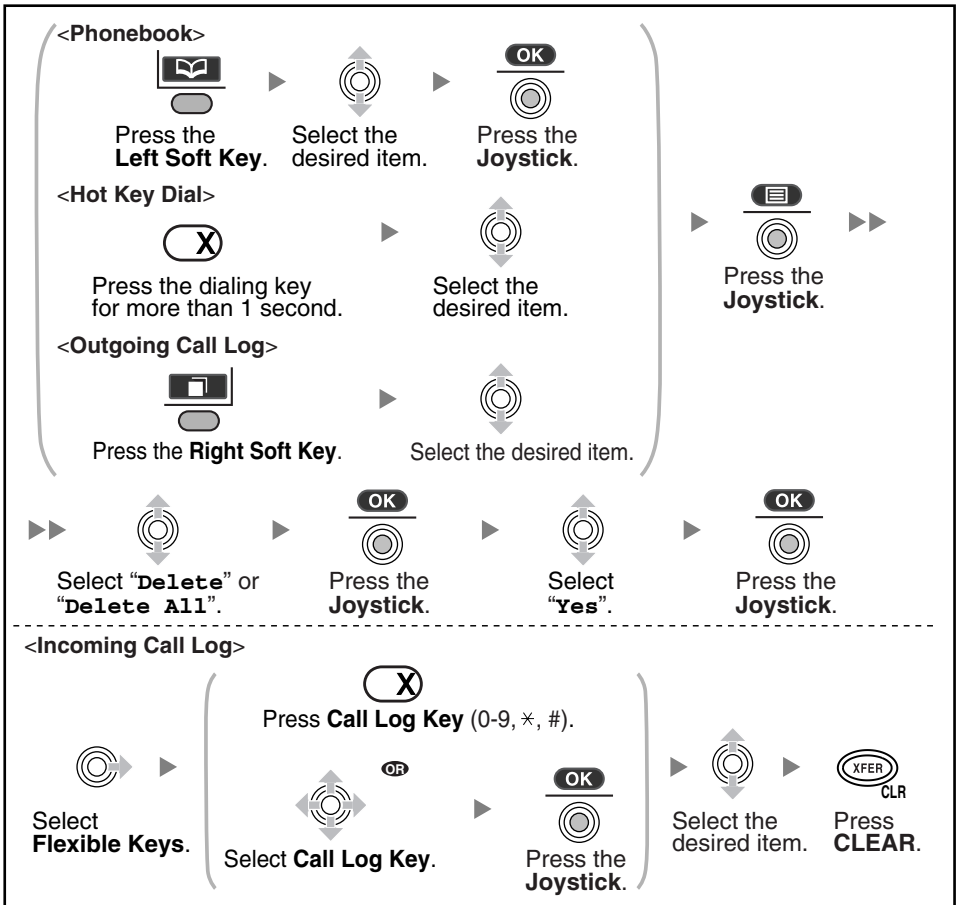



- If you delete a Phonebook item that you also stored as a Hot Key, the Hot Key Dial is also deleted. (See page 24.)

Setting the Handset and Base Unit

◆◆ Setting the Handset and Base Unit

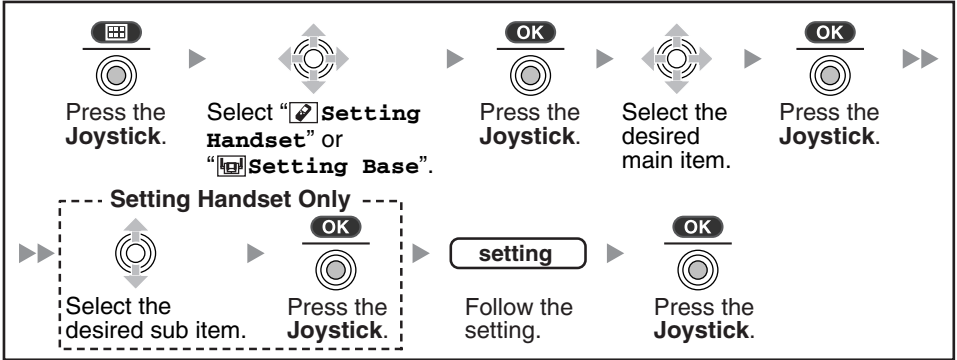
You can customize the handset and base unit by editing the settings found under “Setting Handset” or “Setting Base” in the menu list, as follows:



- To return to the previous menu, press .
- To cancel, press  at any time.
- The unit will beep to indicate that the new settings have been saved.
- For more information, refer to “Handset and Base Unit Menu Layout” on page 30.

Setting the Handset and Base Unit

◆ Handset and Base Unit Menu Layout

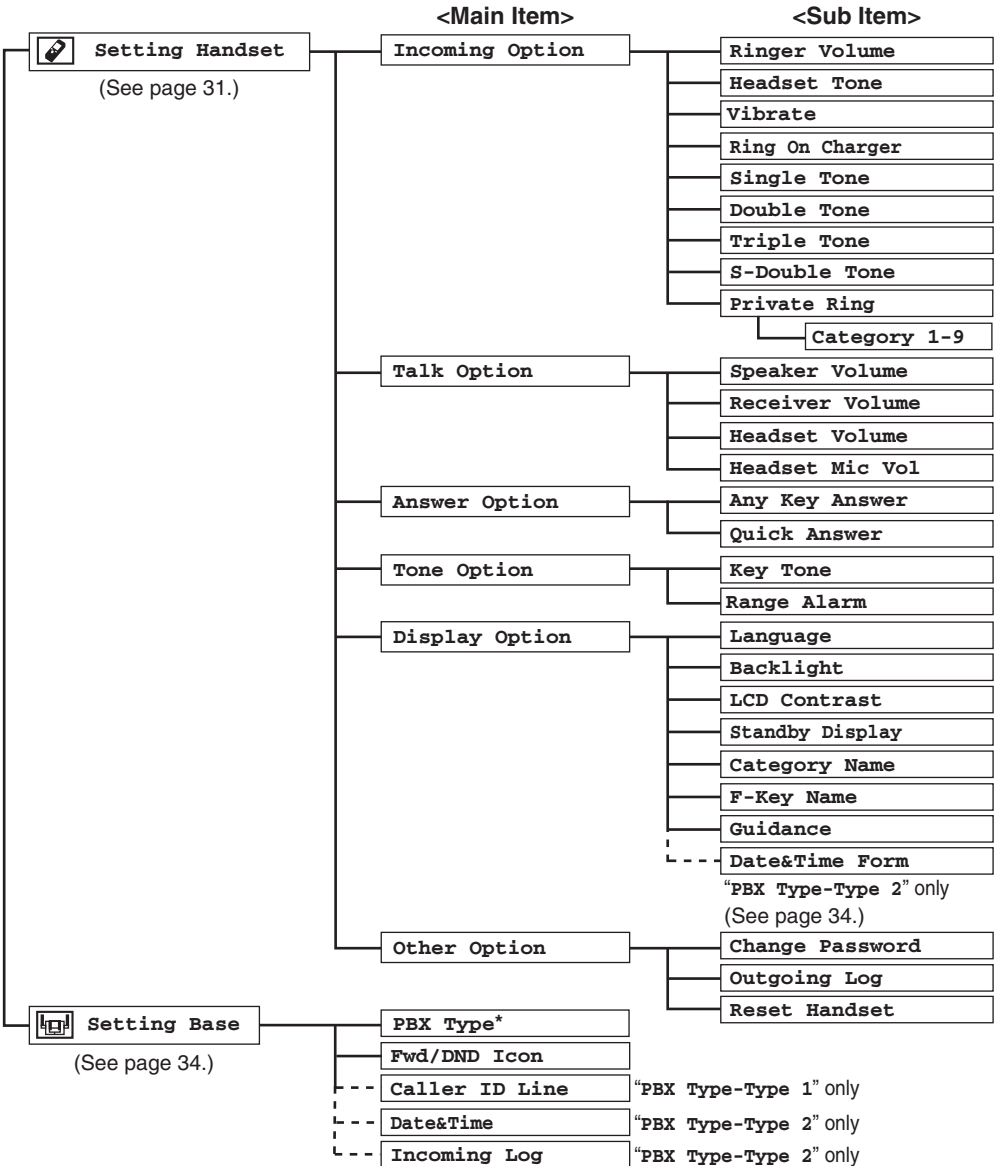

* There are 2 types of PBX

| PBX Type | PBX Models |
|----------|----------------------------|
| Type 1 | KX-TAW848/KX-TDA50/100/200 |
| Type 2 | — |

Setting the Handset and Base Unit

| Main Item | Sub Item | Description | Setting | Default |
|-----------------|--|---|--|--|
| Incoming Option | Ringer Volume | Adjusts the ringer volume. | <input type="checkbox"/> Step Up <input type="checkbox"/> Step Down <input type="checkbox"/> Level 1-6 <input type="checkbox"/> Off | Level 3 |
| | Headset Tone | Selects whether a tone is heard from the attached headset while receiving a call. | <input type="checkbox"/> On <input type="checkbox"/> Off | Off |
| | Vibrate | Selects whether the handset vibrates while receiving a call. | <input type="checkbox"/> Vib.& Ring <input type="checkbox"/> Vib.→ Ring <input type="checkbox"/> Off | Off |
| | Ring On Charger | Selects the ringing mode (On or Off) while a handset is set on the charger.*1 | <input type="checkbox"/> On <input type="checkbox"/> Off | On |
| | Single Tone | Selects the ringer pattern for each type of call. | <input type="checkbox"/> Bell 1-6 <input type="checkbox"/> Melody 1-9 | Bell 1 |
| | Double Tone | | | |
| | Triple Tone | Selects the LED pattern for each type of call.*2 | <input type="checkbox"/> Red <input type="checkbox"/> Green <input type="checkbox"/> Orange <input type="checkbox"/> R→ G→ O | Single Tone: Red Double Tone/ Private Ring: Green Triple Tone: Orange S-Double Tone: R→ G→ O |
| | S-Double Tone | | | |
| Private Ring | Selects the vibrate pattern for each type of call. | | | |
| | <input type="checkbox"/> Category 1-9 | | | |

*1 When "Ring On Charger" is set to on but "Ringer Volume" is set to off, the handset rings at level 1.

*2 The LED pattern does not change when a call is being monitored with the Call Monitor feature.

Setting the Handset and Base Unit

| Main Item | Sub Item | Description | Setting | Default |
|----------------|-----------------|--|--|---------|
| Talk Option | Speaker Volume | Adjusts the rear speaker volume. | Level 1-6 | Level 3 |
| | Receiver Volume | Adjusts the receiver volume. | Level 1-4 | Level 2 |
| | Headset Volume | Adjusts the headset speaker volume. | Level 1-4 | Level 2 |
| | Headset Mic Vol | Adjusts the headset microphone volume. | Level 1-4 | Level 1 |
| Answer Option | Any Key Answer | Answers a call by pressing any dialing key.* ¹ | <input type="checkbox"/> On <input type="checkbox"/> Off | Off |
| | Quick Answer | Answers a call while charging by just lifting up a handset from the charger. | <input type="checkbox"/> On <input type="checkbox"/> Off | Off |
| Tone Option | Key Tone | Turns the key tone off or on. | <input type="checkbox"/> On <input type="checkbox"/> Off | On |
| | Range Alarm | Selects whether the range alarm tone rings or not. | <input type="checkbox"/> Talk <input type="checkbox"/> Idle <input type="checkbox"/> Talk & Idle <input type="checkbox"/> Off | Talk |
| Display Option | Language | Selects the display language. | <input type="checkbox"/> English <input type="checkbox"/> Español <input type="checkbox"/> FRANÇAIS | English |
| | Backlight | Turns on the backlight of the LCD and keypad. | <input type="checkbox"/> On* ² <input type="checkbox"/> On & Receiving <input type="checkbox"/> Off | On |

*¹ This feature functions when receiving Paging or Voice Calls as well.

*² On: The backlight of the LCD and keypad is turned on for about 5 seconds:
 – from the moment a call is received.
 – after operating the handset.

Setting the Handset and Base Unit

| Main Item | Sub Item | Description | Setting | Default |
|------------------|-----------------|--|--|----------------|
| Display Option | LCD Contrast | Adjusts the LCD contrast. | Level 1-5 | Level 3 |
| | Standby Display | Edits the name displayed on the LCD while in standby mode. | 16 characters | Not stored |
| | Category Name | Edits the category name. | Category 1-9 | Not stored |
| | F-Key Name | Edits the names of the flexible keys. (max. 12 characters) | 12 characters × 12 flexible keys | Not stored |
| | Guidance | Selects whether the guidance display is shown or not in standby mode. | <input type="checkbox"/> On <input type="checkbox"/> Off | On |
| | Date&Time Form | Selects the format for the date shown on the display in the Incoming Call Log. "PBX Type-Type 2 (KX-TA308/TD series)" only (See page 34.) | <input type="checkbox"/> DD-MM 12H <input type="checkbox"/> DD-MM 24H <input type="checkbox"/> MM-DD 12H <input type="checkbox"/> MM-DD 24H | DD-MM 12H |
| Other Option | Change Password | Changes the handset password. (4 digits) | <input type="checkbox"/> Enter Old Password.+ <input type="checkbox"/> Enter New Password.+ <input type="checkbox"/> Verify New Password. | 1234 |
| | Outgoing Log | Selects whether to save an outgoing log or not. | Enter Password.+ <input type="checkbox"/> On <input type="checkbox"/> Off | Off |
| | Reset Handset | Returns the handset settings (except Registration) to the default settings. | <input type="checkbox"/> Enter Password.+ <input type="checkbox"/> Select menu(s).+ <input type="checkbox"/> Press "OK". | Not stored |

Setting the Handset and Base Unit

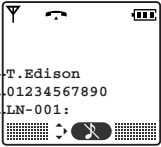
| Main Item | Description | Setting | Default |
|---|--|--|--|
| <input type="text" value="PBX Type"/> | Selects the type of PBX that the base unit is connected to.*1 | <input type="checkbox"/> Type 1*2 <input type="checkbox"/> Type 2 | Type 1 |
| <input type="text" value="Fwd/DND Icon"/> | When using a KX-TAW848/KX-TDA series PBX, and the PT LED patterns for FWD and DND have been set reversely on the PBX, you need to set Mode 2. (See page 6.) | <input type="checkbox"/> Mode 1 <input type="checkbox"/> Mode 2 | Mode 1 |
| <input type="text" value="Caller ID Line"/> "PBX Type-Type 1 (KX-TAW/TDA series)" only | Selects which line of information is displayed as Caller ID. When the Caller ID matches an item stored in the Phonebook, the handset rings according to the setting of the item. As shown below, a caller's number, caller's name and CO line number are displayed on each line. Displayed items vary depending on your PBX and its settings. <Example>  1st LineT. Edison 2nd Line.....01234567890 3rd LineLN-001: | <input type="checkbox"/> 1st Line <input type="checkbox"/> 2nd Line <input type="checkbox"/> 3rd Line | 1st Line |
| <input type="text" value="Date&Time"/> "PBX Type-Type 2 (KX-TA308/TD series)" only | Sets the current date and time for the base unit. | Date Time | 01-01-05 (D-M-Y) 12:00 AM (H:M) |
| <input type="text" value="Incoming Log"/> "PBX Type-Type 2 (KX-TA308/TD series)" only | Sets each type of Incoming Call Log to either on or off.*3 You must set at least one of the incoming call types to on to store a received call in the Incoming Call Log. | Single Tone <input type="checkbox"/> On <input type="checkbox"/> Off Double Tone <input type="checkbox"/> On <input type="checkbox"/> Off Triple Tone <input type="checkbox"/> On <input type="checkbox"/> Off | Single Tone: Off Double Tone: Off Triple Tone: Off |

*1 After you set the PBX type, disconnect and reconnect the telephone cord.

*2 To check the type of PBX you are using, see page 30.

*3 When a check mark is displayed beside a tone type, the incoming call log for that tone type will be logged.









- These settings are only applied to your telephone, not the PBX itself.

Troubleshooting and Error Messages

◆◆ Troubleshooting

| Problem | Description and Solution |
|---|---|
| The handset does not work. | <ul style="list-style-type: none">• The battery is drained. → Charge the battery fully. (See “Charging the Battery” in the Installation Instructions.)• The power is OFF. → Turn it ON. (See “Handset” on page 3.) → Re-insert the battery and try again. (See “Battery Installation” in the Installation Instructions.) |
| The handset does not ring. | <ul style="list-style-type: none">• Ringer volume is set to “OFF”. → Adjust the ringer volume level. (See “Adjusting the Ringer Volume” on page 8.) |
| You cannot make/receive a call. | <ul style="list-style-type: none">• The handset is out of range or the telephone line is not connected properly. → Move closer to the base unit. → Check the telephone line. |
| You cannot dial. | <ul style="list-style-type: none">• The number which you dialed is restricted by the PBX. → Consult your dealer.• The key lock mode is ON. → To cancel the mode, press the Joystick for about 2 seconds. (See “Key Lock” on page 4.) |
| You cannot use the handset during a power failure. | <ul style="list-style-type: none">• The handset will not function during a power failure because the base unit stops emitting radiowaves. |
| The headset does not work. | <ul style="list-style-type: none">• A headset tone cannot be heard when receiving an incoming call, when the headset is attached. → Make sure the headset tone setting is set to on. (See page 31.) → Make sure the headset jack is connected properly. (See “Handset” on page 3.) |
| The tone from the headset cannot be changed to a bell or melody. | <ul style="list-style-type: none">• The headset tone is a specific tone and is not related to the Incoming Option Tone settings (Single/Double/Triple/S-Double/Private Ring). |
| The date and time are not displayed correctly when viewing the Incoming Call Log. | <ul style="list-style-type: none">→ Time settings can only be changed on the PBX. |
| After performing settings for Fwd, DND settings are displayed, or vice versa. | <ul style="list-style-type: none">→ Check the Fwd/DND Icon setting in “Setting Base”. If it is set to Mode 2, change to Mode 1, or vice versa. (See “Selecting the Fwd/DND Icon” on page 6.) |
| Some dialed calls are not stored in the Outgoing Call Log. | <ul style="list-style-type: none">→ Outgoing calls using some PBX features (e.g., Redial, One-touch Dialing or Speed Dialing) cannot be stored in the Outgoing Call Log. |

Troubleshooting and Error Messages

| Problem | Description and Solution |
|---|--|
| <p>Even when in standby mode, you cannot access the Phonebook or other menus. ( is displayed in standby mode.)</p> | <ul style="list-style-type: none"> • The BGM setting may be on. → Press  then    , and press . |
| <p>Noise is frequently heard.</p> | <p>→ Set the handset and base unit away from other electrical appliances. → Move closer to the base unit.</p> |
| <p>Two short beeps are heard during a conversation.</p> | <ul style="list-style-type: none"> • The radio signal is weak. → Move closer to the base unit. |
| <p>The charge indicator flashes red rapidly.</p> | <ul style="list-style-type: none"> • The charger is not connected properly. → Make sure the battery is inserted properly. → Set the handset in the charger properly. |
| <p>You charged the battery for 7 hours, but the beep tones sound every 5 seconds and  (needs to be charged) flashes after a few telephone calls.</p> | <ul style="list-style-type: none"> • The battery charge contacts may be dirty. → Clean the battery charge contacts without damaging them and charge once more. • It is time to change the battery. → Replace with a new one. |
| <p>The battery indicator does not display the remaining charge properly after you replace the battery.</p> | <p>→ Charge the battery for about 7 hours when the low battery warning is displayed.</p> |
| <p>While operating the unit, the AC adaptor feels warm. While charging the battery, the handset feels warm.</p> | <ul style="list-style-type: none"> • These are normal conditions. |

Troubleshooting and Error Messages

◆◆ Error Messages

| Displayed Message | Description and Solution |
|---------------------------------|---|
| No Service | <ul style="list-style-type: none">• The handset is out of range. → Move closer to the base unit.• The base unit is turned off. → Make sure the power cord is connected. |
| Not Connected | <ul style="list-style-type: none">• The telephone cord between the PBX and the base unit is not connected. → Make sure the telephone cord is connected. |
| Please Wait... | <ul style="list-style-type: none">• The handset is connecting to the base unit. → Wait for a moment. |
| Charge Battery | <ul style="list-style-type: none">• The handset battery has little charge remaining. → Charge the battery fully. (See “Charging the Battery” in the Installation Instructions.) |
| Memory Empty | <ul style="list-style-type: none">• When trying to view the Phonebook: No items have been stored. (See “Storing an Item in the Handset Phonebook” on page 23.)• When trying to view the Incoming or Outgoing Call Log: No logs have been stored. |
| Memory Full | <ul style="list-style-type: none">• The Phonebook is full, and cannot store the new item. → Remove unnecessary data in the Phonebook, and try again. |
| Over 24 Digits can't be stored. | <ul style="list-style-type: none">• You are trying to store a telephone number that is over 24 digits in the last free space in the Phonebook. → Try to store the phone number as 24 digits or less, or remove unnecessary data in the Phonebook. |
| Need Repair 1(-2) | → Consult your dealer. |

Important Information

Battery Information

After your Panasonic battery is fully charged [at 25 °C (77 °F)]:

| Operation | Operating Time |
|----------------------------|-------------------|
| While in use (Talk) | Up to about 10 h |
| While not in use (Standby) | Up to about 250 h |

- Operating time may be shortened depending on usage conditions and ambient temperature.
- The battery will drain slowly even while the unit is turned off.
- The handset can receive calls while charging.
- Battery consumption increases when the handset is used out of range. If “Y” flashes, power off the handset.

◆ Low Battery Warning

The battery needs to be charged in the following situations:

- “” flashes or the alarm sounds every 5 seconds.*
- “Charge Battery” is displayed. In this situation, the handset cannot be operated.

* If the low battery warning occurs during a conversation, the call will be disconnected automatically one minute later.

◆ Replacing the Battery

If “” flashes after using the phone for a short time, even when the battery has been fully charged, the battery should be replaced.

Before replacing the battery, make sure the low battery warning is displayed, then turn off the power to prevent memory loss. Replace the battery, and charge the new battery for at least 7 hours.

If you replace the battery before the low battery warnings appears, the battery strength icon may display an incorrect reading. In this case, use the handset as normal with the new battery installed. When the low battery warning is displayed, charge the battery for about 7 hours. The battery strength icon will then display the correct reading.

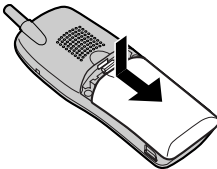

1. Turn the power off to prevent memory loss.
2. Press the notch on the cover firmly and slide it as indicated by the arrow.
3. Open the cover and replace the battery.
4. Close the cover and charge the handset.

- Please use a Panasonic battery with the service part number N4HHGMB00005 or HHR-P103.



This product is powered by a recyclable nickel-metal hydride battery.

Please call 1-800-8-BATTERY for information on how to recycle this battery.

There is a danger of explosion if the battery is incorrectly replaced.



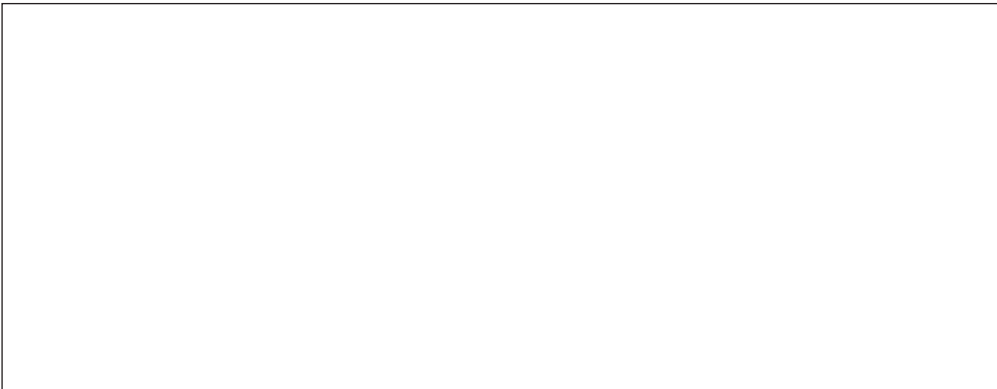

Panasonic Consumer Electronics Company
Division of Panasonic Corporation of
North America
One Panasonic Way,
Secaucus, New Jersey 07094
<http://www.panasonic.com/csd>

Panasonic Puerto Rico, Inc.
Ave. 65 de Infantería, Km. 9.5,
San Gabriel Industrial Park, Carolina,
Puerto Rico 00985

Copyright:

This material is copyrighted by Panasonic Communications Co., Ltd., and may be reproduced for internal use only. All other reproduction, in whole or in part, is prohibited without the written consent of Panasonic Communications Co., Ltd.

© 2005 Panasonic Communications Co., Ltd. All Rights Reserved.

PSQX3970ZA KK0905ST0