

Panasonic

DECT Portable Station

Operating Instructions

Model No. KX-TCA155



Thank you for purchasing the Panasonic KX-TCA155, DECT Portable Station. Please read this manual carefully before using this product and save this manual for future use.

This manual is designed to be used with the KX-TCA155 DECT Portable Station and a Panasonic KX-TDA series Business Telephone System.

Charge the battery for about 7 hours before initial use.

Table of Contents

Before Initial Use	4
Before Operating the PS	5
Location of Controls	5
Connection	6
Battery Installation.....	7
Battery Charge	7
Power On/Off	8
Display Icons.....	8
Operation Outline	9
Function Menu Display.....	10
PBX Feature Menu.....	11
Flexible Key Display.....	11
Soft Key Display.....	12
Ringer Volume Adjustment	13
Receiver/Speaker Volume Adjustment	13
Key Lock	13
Selecting the Display Language.....	14
Making Calls	15
Calling Another Extension	15
Calling an Outside Party	15
Using the Call Log.....	16
Using the Phonebook.....	17
Hot Key Dial	19
Receiving Calls	20
Intercom Calls/Outside Calls/Group Calls.....	20
Temporary Ringer Volume Adjustment	20
Caller ID	21
During a Conversation	22
Transferring a Call.....	22
Holding	22
Turning the Microphone On/Off.....	23
Using the Phonebook	24
Handset Phonebook.....	24
Hot Key Dial	27
Entering Characters	27
Feature List	29
Programming	33
Changing the Initial Settings	33
Others	41
Walkie-Talkie.....	41
Using the Belt Clip.....	42

Table of Contents

Wall Mounting	43
Troubleshooting.....	44
Troubleshooting	44
Important Information.....	45
Battery Information.....	45
Safety Instructions.....	46



Before Initial Use

Please read "Important Information" on page 45 before use. Read and understand all instructions.

◆ Registration

Your PS (Portable Station) must be registered in the Business Telephone System and you have to determine the extension number before initial use.

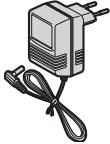
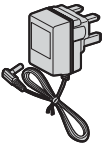
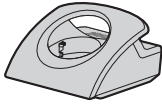
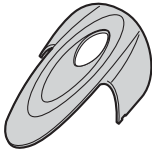
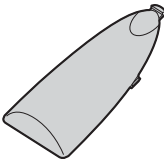
◆ Accessories (included)

<input type="checkbox"/> AC adaptor For the KX-TCA155CE users: PQLV200CE  One For the KX-TCA155E users: PQLV200E  One	<input type="checkbox"/> Charger  One	<input type="checkbox"/> Belt Clip  One
<input type="checkbox"/> Battery Cover  One	<input type="checkbox"/> Rechargeable Batteries- AAA size (HHR-4EPT/BA2)  Two	<input type="checkbox"/> CD-ROM..... One <input type="checkbox"/> Quick Guide..... One



• In this manual, the suffix of each model number is omitted.

Some of the features described in this manual are not available when the PS is used with a Panasonic KX-TD816/KX-TD1232 Business Telephone System, only the single line telephone (SLT) features are available.

◆◆ Location of Controls

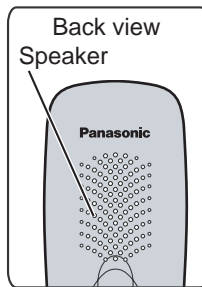
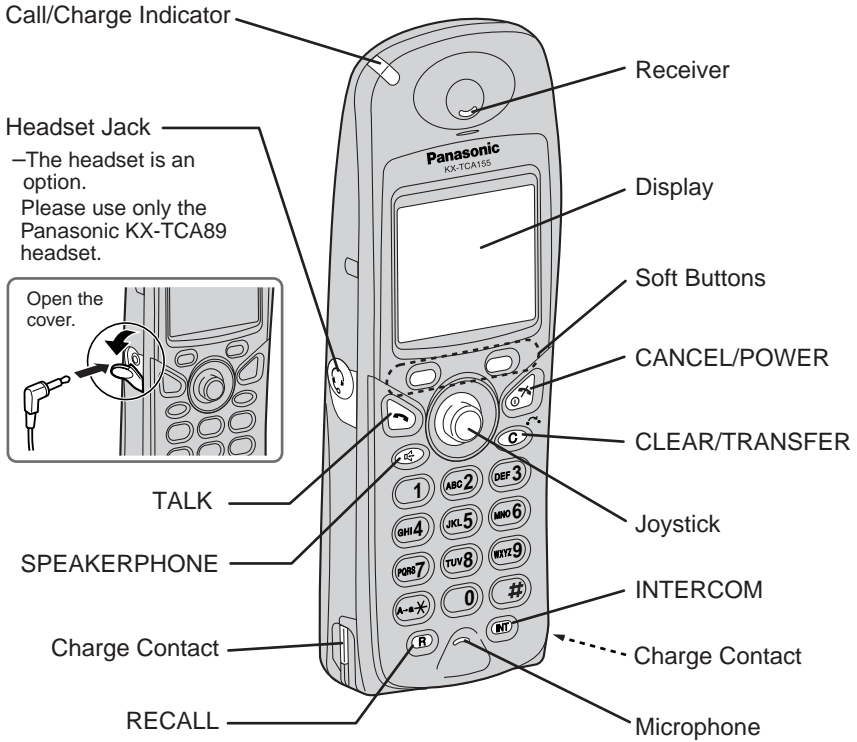

Before Operating the PS



TALK Button:
Used to make or receive calls.



Joystick:
Used to adjust the ringer/receiver volume, select the Function mode and the function displayed directly above, and move the cursor to select a desired item.



SPEAKERPHONE Button:
Used for the hands-free conversation. Press TALK button to return to the receiver.



RECALL Button:
Used to disconnect the current call and make another call without hanging up, or answer Call Waiting from the telephone company.



INTERCOM Button:
Used to make or receive intercom calls.



CLEAR/TRANSFER Button:
Used to clear digits or characters, or transfer a call to another party.



CANCEL/POWER Button:
Used to end calls, exit the Phonebook or Function mode, or turn on/off the PS.



Soft Buttons:
Used to select the function displayed directly above each button. Functions displayed depend on the state of use.

◆◆ Connection

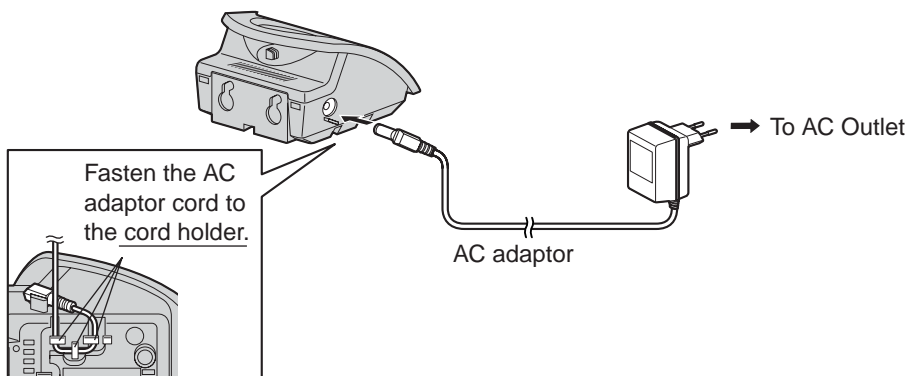

- **USE ONLY the Panasonic AC ADAPTOR.**
For the KX-TCA155CE users: PQLV200CE
For the KX-TCA155E users: PQLV200E

◆◆ Battery Installation

Insert the batteries as shown. The negative ⊖ end should be inserted first. Close the cover as indicated by the arrow.

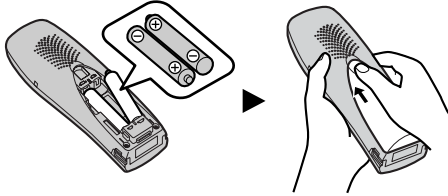

- When you replace the batteries, the positive ⊕ end should be removed first.

◆◆ Battery Charge

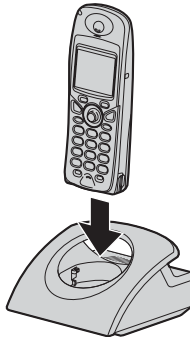

At the time of shipment, the batteries are not charged. **Please charge the batteries for about 7 hours before initial use.**



- When the battery has been completely charged, the charge indicator will change from red to green. Refer to “Battery Information” on page 45.
- It is normal for the PS and charger to feel warm while the battery is charging.
- Keep devices sensitive to magnetic fields away from the charger.

Before Operating the PS

◆◆ Power On/Off











<p>Power On</p>  <p>Press POWER for about 2 seconds.</p>	<p>Power Off</p>  <p>Press POWER for about 2 seconds. The display will go blank.</p>
---	---



- When the PS is turned on, it will be in standby mode. Standby mode is the state of the PS when it is not performing any operations and is awaiting calls.

◆◆ Display Icons



-  Within range of a Cell Station
-  Out of range, No registration
-  Intercom Indicator
-  Off-hook Status
-  Message Waiting
-  Phonebook Mode
-  Battery strength
-  Hot line ON
-  Ringer Volume OFF
-  Call Forwarding
-  Do Not Disturb

◆◆ Operation Outline

Functions of the PS are accessed through the display menu, and selected with the joystick and soft keys. The guidance display is shown in standby mode for easy operation.

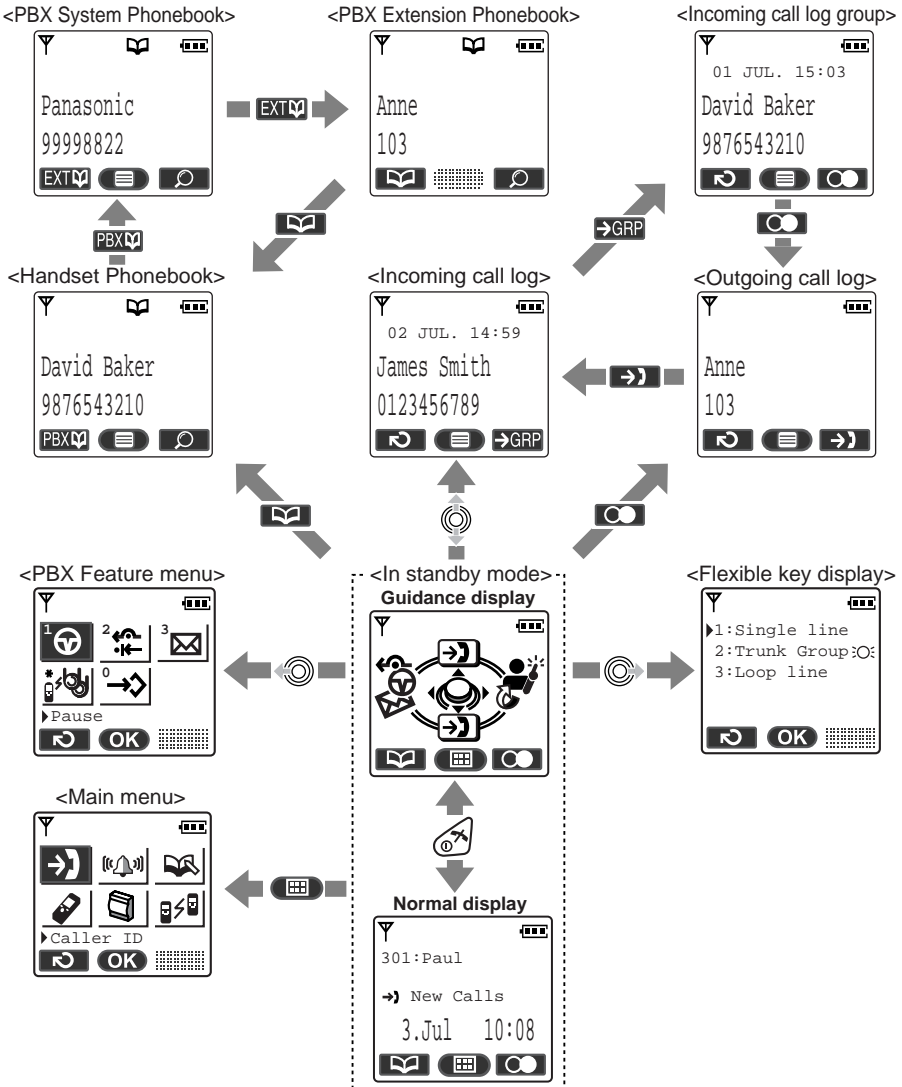

- You cannot toggle the displays while in key lock mode or while the PS is on a charger.
- You can select whether the guidance display is shown or not. (See page 36.)

Before Operating the PS

◆◆ **Function Menu Display**

Press the joystick to display the function menu.

◆ **Main menu – while in standby mode**



Caller ID:
Displays the incoming call log.



Ringer Option:
Accesses to the “Ringer Option”.



New Phonebook:
Stores a new item in the Handset Phonebook.



Setting Handset:
Accesses to the “Setting Handset”.



PBX Program:
Enters the PBX programming mode.



Walkie-Talkie:
Sets or turns on/off the Walkie-Talkie mode.
(See page 41.)

◆ **Sub menu – while in off-hook/during a conversation**

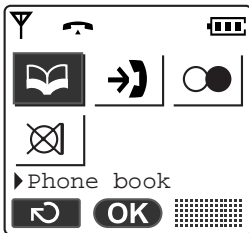

Phone book:
Accesses to the Phonebook.



Caller ID:
Displays the incoming call log.



Redial:
Displays the outgoing call log.



Mute:
Turns the microphone on/off.

◆◆ PBX Feature Menu

Functions of the PS can be activated through the display key list. Move the joystick left to display the key list.

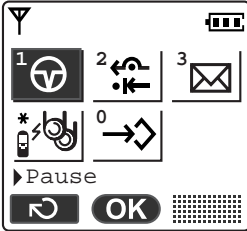

Pause:

Inserts a dialling pause.



FWD/DND:

Sets Call Forwarding or Do Not Disturb.



Message:

Used to leave a message waiting indication or call back the party who left you a message waiting indication.



Search Wave:

Searches the strongest radio signal coming from the Cell Station.



PBX Program:

Used to enter programming mode.

◆◆ Flexible Key Display

The flexible key can be used to seize an line while making or receiving an outside call (F-CO key), or used as a function key. Move the Joystick right to display the F-CO key list. Icons shown in the F-CO list function similarly to the LED indicator on a Proprietary Telephone; ● is the same as a green LED, and ○ is the same as a red LED.

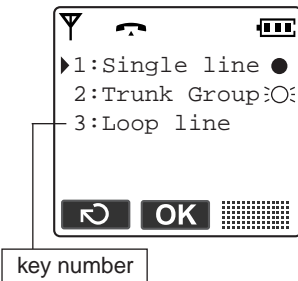

Example:



Understanding the F-CO Key List*

- (on): You are currently using this line.
- ⊙ (flashing rapidly): You have an incoming call on this line.
- ⊙ (flashing slowly): You have a call on hold on this line.
- (on): This line is in use by someone else.
- ⊙ (flashing rapidly): There is an incoming call received by an incoming call distribution group to which "Ring" is set as the group call distribution method.
- ⊙ (flashing slowly): Someone has a call on hold on this line.
- (no icon): This line is idle.

































- The meanings of these icons vary depending on the status of the CO line.
- For further information, refer to "LED Indication" in the KX-TDA series Business Telephone System Feature Guide.
- To select a key, press its key number, or move the Joystick  to select the desired key then press .
- To assign a function to a flexible key, see page 39.

Before Operating the PS

◆◆ Soft Key Display

Icons and information shown on the display will vary depending on the state of use. To select an item shown on the display, press the corresponding soft buttons.

- | | | | |
|--|--------------------------------------|---|--|
|  | Opens the Handset Phonebook. |  | Used to clear the memo alarm display setting, or enter an X when storing the "Line Access CD". |
|  | Opens the function menu. |  | Used to select an item when in setting mode. |
|  | Used to redial. |  | Displayed when in  (Alphabetic) character entry mode. |
|  | Used to confirm the entry. |  | Displayed when in  (Numeric) character entry mode. |
|  | Turns the ringer off. |  | Displayed when in  (Greek) character entry mode. |
|  | Opens the PBX System Phonebook. |  | Displayed when in  (Extended 1) character entry mode. |
|  | Opens the PBX Extension Phonebook. |  | Displayed when in  (Extended 2) character entry mode. |
|  | Opens the incoming call log. |  | Displayed when in key lock, and used to unlock the dialling buttons. |
|  | Opens the incoming call log group. |  | Used to search for an item in the Phonebook alphabetically. |
|  | Displays the next screen. |  | Used to place a call on hold. |
|  | Clears digits or characters. |  | Used to establish a multiple-party conversation. |
|  | Inserts a dialling pause. | | |
|  | Returns to the previous screen. | | |
|  | Used to set the time for memo alarm. | | |

◆◆ Ringer Volume Adjustment

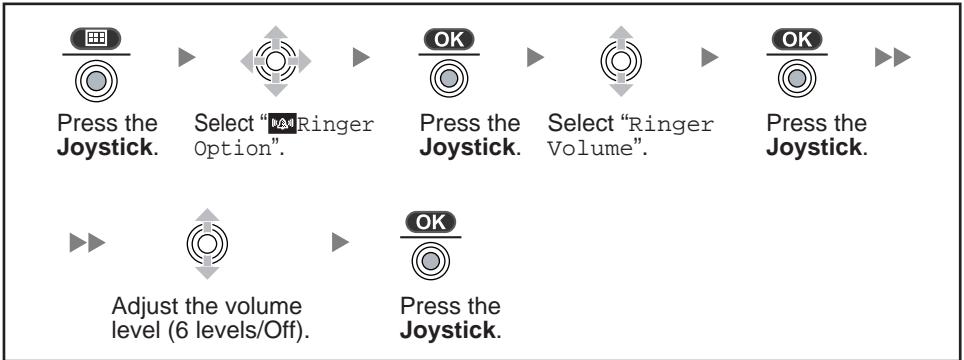

◆◆ Receiver/Speaker Volume Adjustment

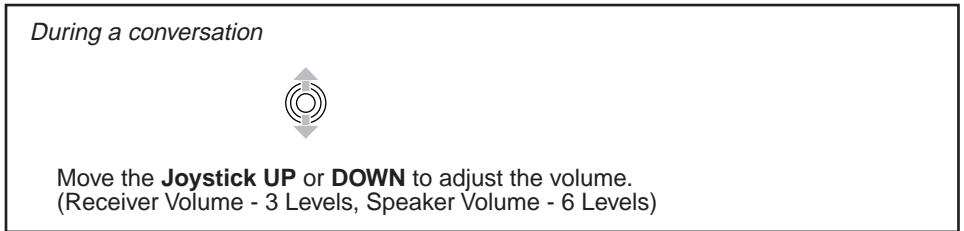

◆◆ Key Lock

You can lock the dialling buttons while the PS is in idle status.

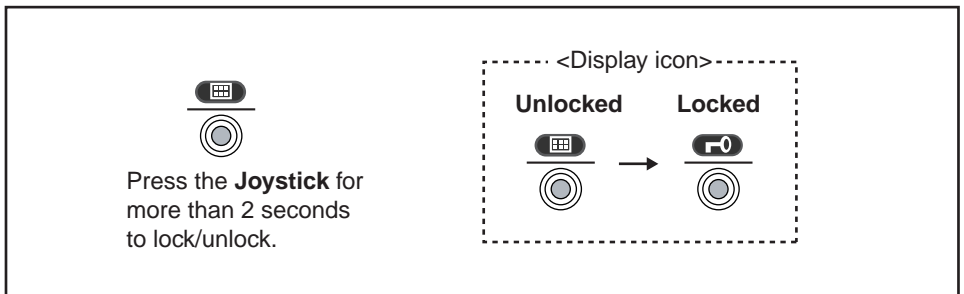

Before Operating the PS

◆◆ Selecting the Display Language

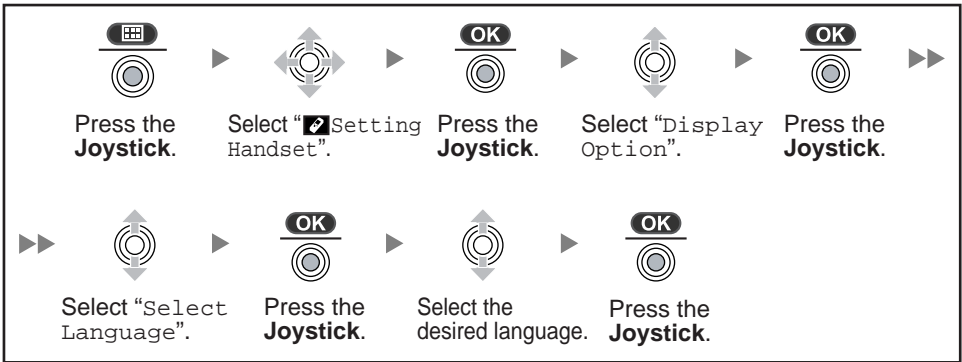

- You can select one of 16 languages:
Deutsch, English, Español, FRANCAIS, Italiano, Dansk, Nederlands, Svenska, Suomi, ΕΛΛΗΝΙΚΑ, Magyar, Português, Polski, slovensky, čeština, Hrvatski
- The display language of both the PS and Business Telephone System can be selected, and both should be set to the same language. Refer to the Business Telephone System User manual for more details.

◆◆ Calling Another Extension

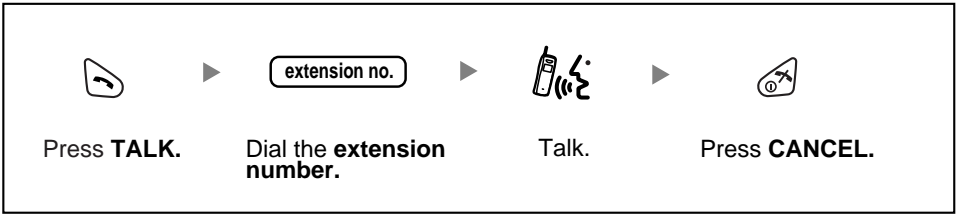



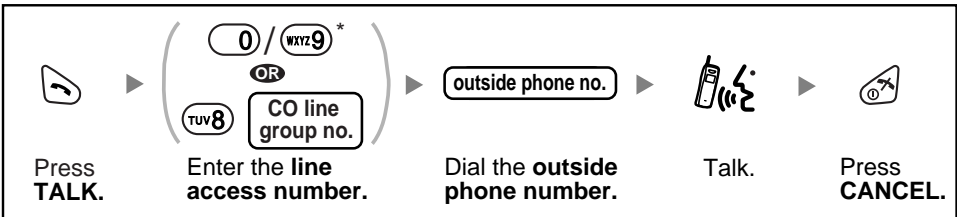

◆◆ Calling an Outside Party

◆ Using the line access numbers

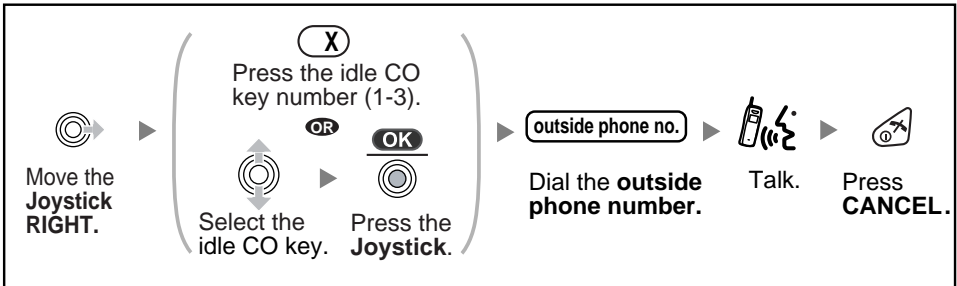



◆ Using Flexible CO keys



- * The line access number (default) varies depending upon Country/Area. Consult your dealer for more details.
- You can confirm a number was dialed correctly before calling (**Predialling**) by entering the number, then pressing .
- To clear an entire number while predialling, press and hold .
- If “Y” flashes, move closer to the Cell Station and dial again.
- To cancel dialling, press .

Making Calls

◆◆ Using the Call Log

Feature	Display Icon	Description
Outgoing Call Log		You can make a call using the phone numbers you have dialed previously.
Incoming Call Log		You can make a call using the phone numbers of calls you have received.
Incoming Call Log Group		You can make a call using the phone numbers of calls that incoming call distribution groups have received.

◆ Using the outgoing call log

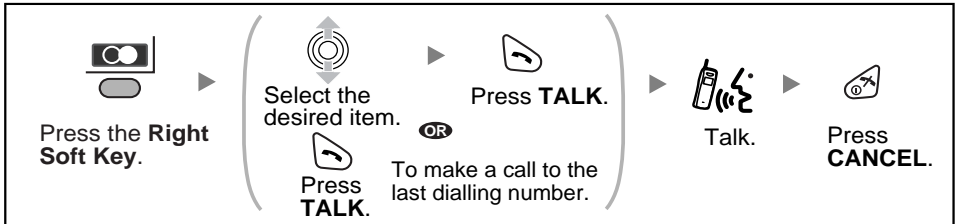

◆ Using the incoming call log



◆ Using the incoming call log group

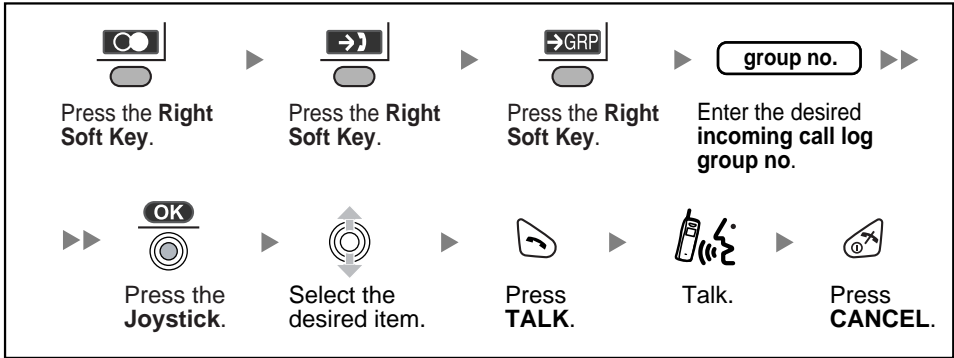

- An outside number stored with a name in the Handset Phonebook will be displayed by number and name in the call log.

◆◆ Using the Phonebook

Feature	Display Icon	Description
Handset Phonebook		You can make a call using the numbers stored in the Handset Phonebook.
PBX System Phonebook		You can make a call using the numbers stored in the Business Telephone System.
PBX Extension Phonebook		You can make a call using the extension numbers stored in the Business Telephone System.

◆ Handset Phonebook

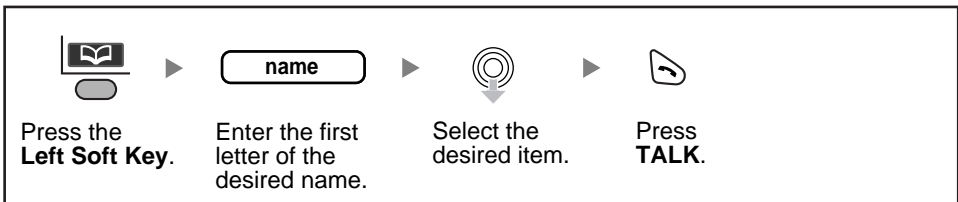

Making Calls

◆ PBX System Phonebook

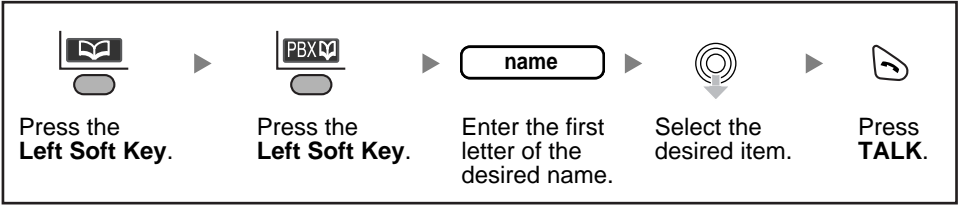

◆ PBX Extension Phonebook

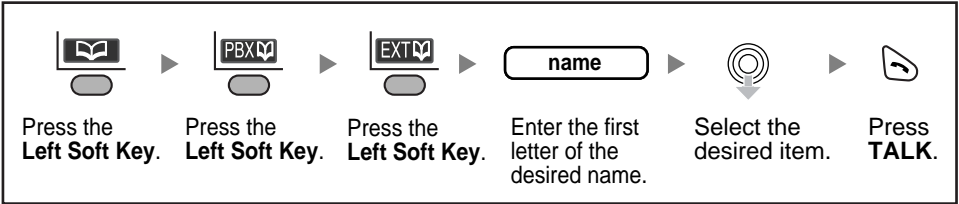

- You can search for an item stored in the Phonebook, as shown below:

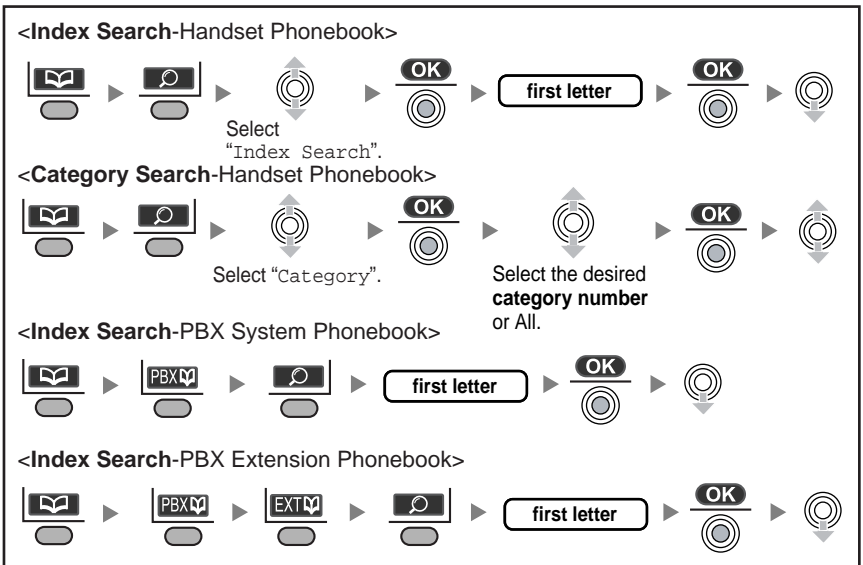

- To enter characters, see page 27.

◆◆ Hot Key Dial

You can make a call by simply pressing the assigned number as hot key.

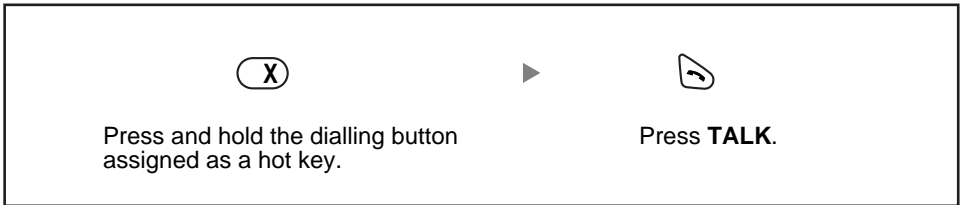

- To assign a phone number as hot key, see page 27.

Receiving Calls

◆◆ Intercom Calls/Outside Calls/Group Calls

While receiving a call

Intercom Calls/Outside Calls/Group Calls

To answer a call when the PS is ringing



Press **TALK**.

Talk.

Press **CANCEL**.

Intercom Calls/Group Calls

To answer a call when the PS is ringing



Press **INTERCOM**.

Talk.

Press **CANCEL**.

Outside Calls

To answer a call on a specific line



Move the **Joystick RIGHT**.

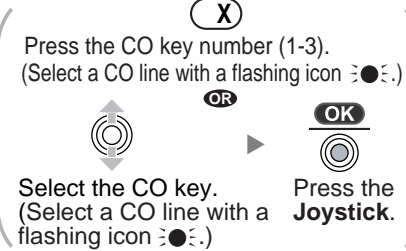

Talk.



Press **CANCEL**.



• You can also answer a call as follows:

- **Auto Talk** (See page 36.)
- **Any Key Answer** (See page 37.)
- **Auto Answer** (See page 37.)

◆◆ Temporary Ringer Volume Adjustment

While receiving a call



Move the **Joystick UP** or **DOWN** to adjust the volume.

OR



Press the **Joystick** to turn the ringer off.

◆◆ Caller ID

If an outside call which contains Caller ID information is received, this information will be logged in the incoming call log.

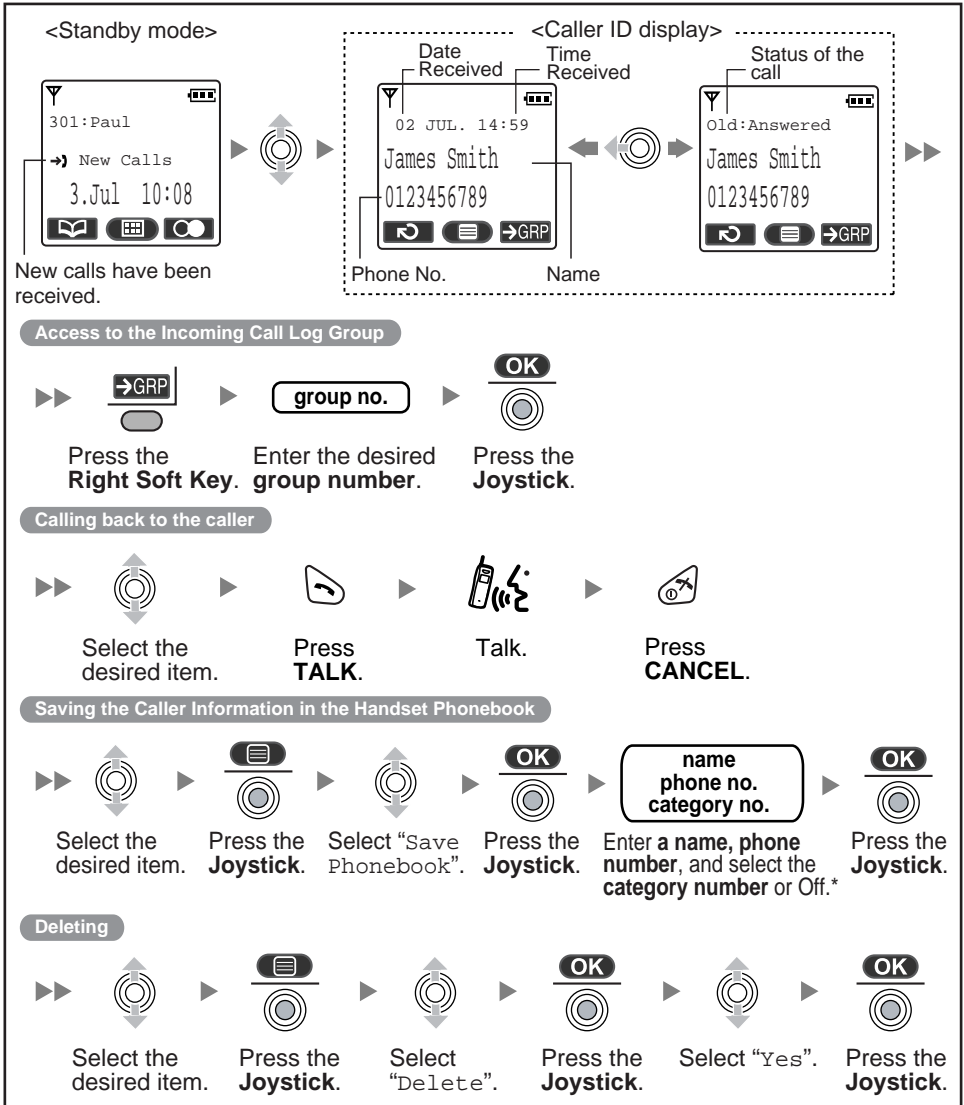

* Press to confirm each entries.

During a Conversation

◆◆ Transferring a Call

◆ Transferring to an extension

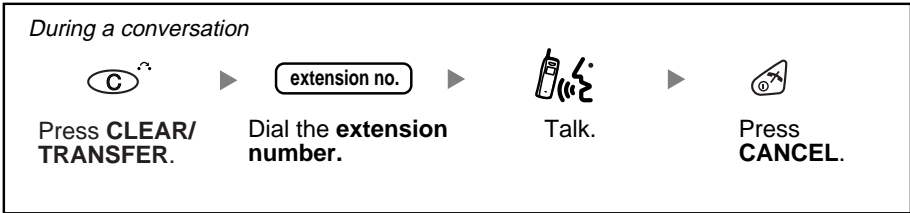

◆ Transferring to an outside party

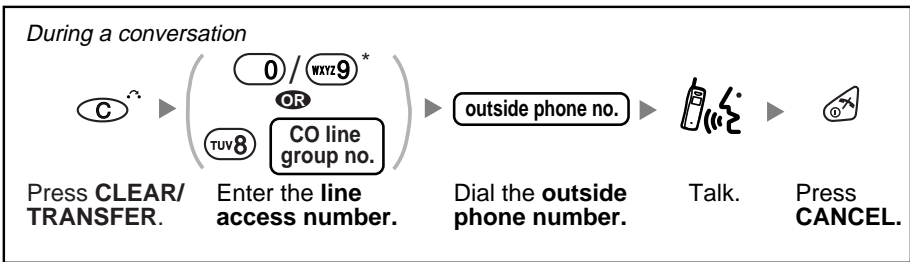

- * The line access number (default) varies depending upon Country/Area. Consult your dealer for more details.
- To return to the call before the transfer destination answers, press CLEAR/TRANSFER.

◆◆ Holding

◆ To hold (Regular Hold)

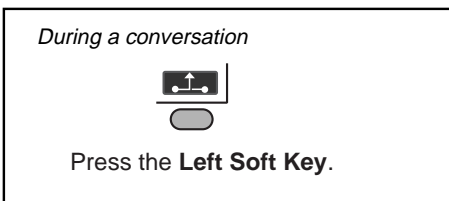

◆ To hold (Exclusive Call Hold)

You can hold a call exclusively so that other people cannot retrieve the call.

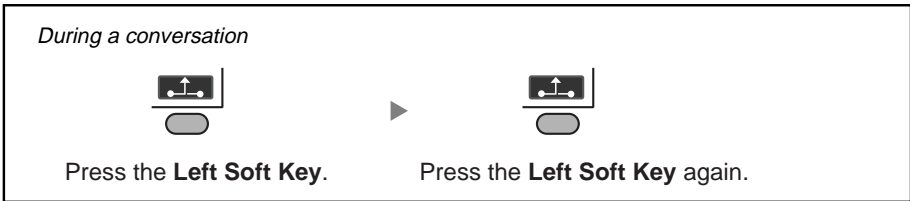

- The method used to hold a call depends on the Call Hold mode (Regular Hold/ Exclusive Call Hold). Ask your manager what the current mode is.
- When you hold several outside line calls, you need to assign the CO keys (Single line/Group line/Loop Line/ICD Group) to a flexible key as necessary, beforehand.

◆ To retrieve a call

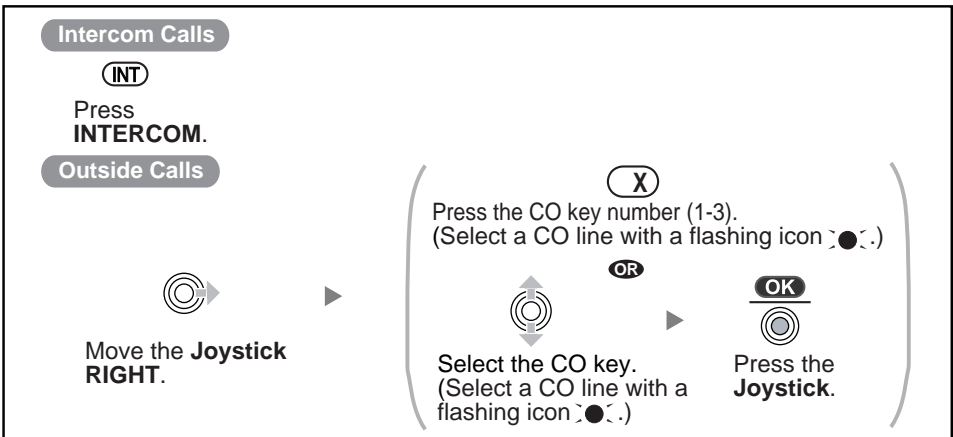

◆◆ Turning the Microphone On/Off

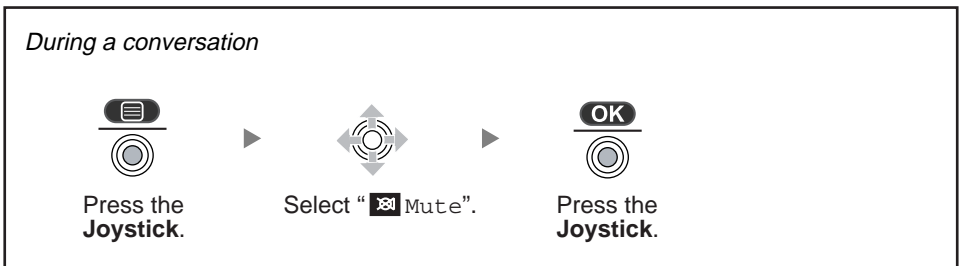

Using the Phonebook

◆◆ Handset Phonebook

You can store up to 200 items with names, phone numbers and category numbers in the handset for easy access. All directory items are stored in alphabetical order.

◆ Incoming Call Identification

You can organise entries in the Handset Phonebook into one of 9 categories. A call from someone stored in one of these categories will be indicated by the ringer type, light (LED) colour pattern assigned to the category.

Item	Setting
Ringer pattern	15 ringer type (See page 35.)
LED colour pattern	3 patterns (See page 35.)

◆ Storing a new item

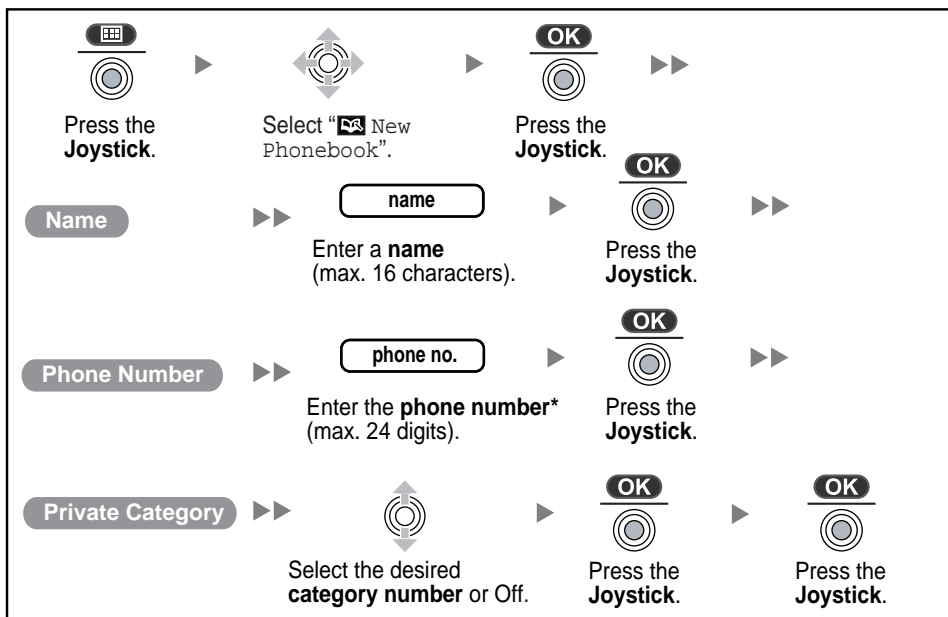

- To enter characters, refer to page 27.
- * The valid digits are "0" through "9", "×", "#", PAUSE.
- When storing numbers for outside parties, you should store a line access number with each number.

◆ Editing

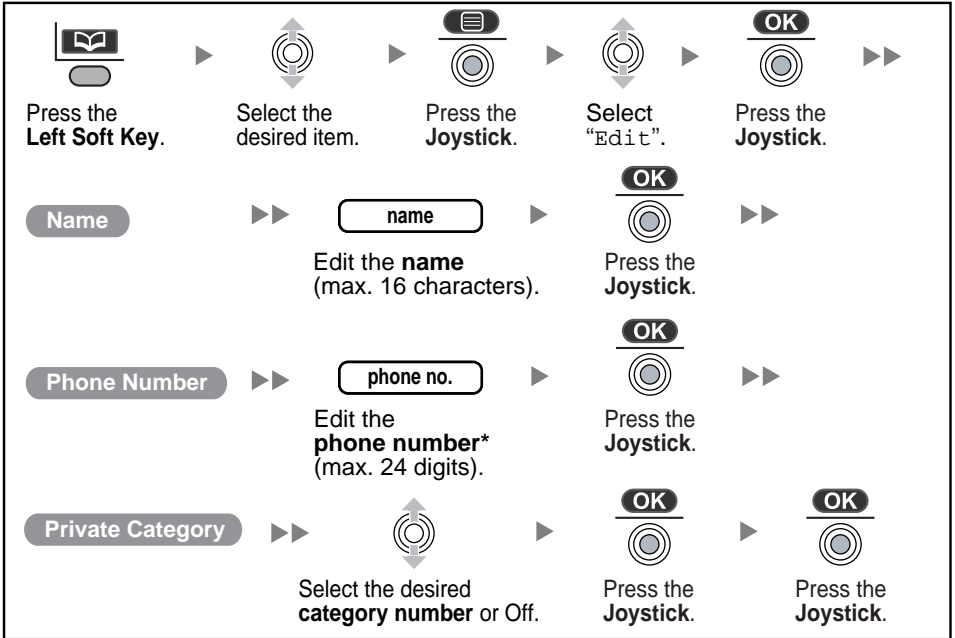

- To enter characters, refer to page 27.
- * The valid digits are "0" through "9", "×", "#", PAUSE.
- To change a character or digit, press to highlight it, press to delete it, then enter the new character or digit.
- To clear an entire line, press and hold .
- To move the cursor to the left or right, press or , respectively.

◆ Deleting

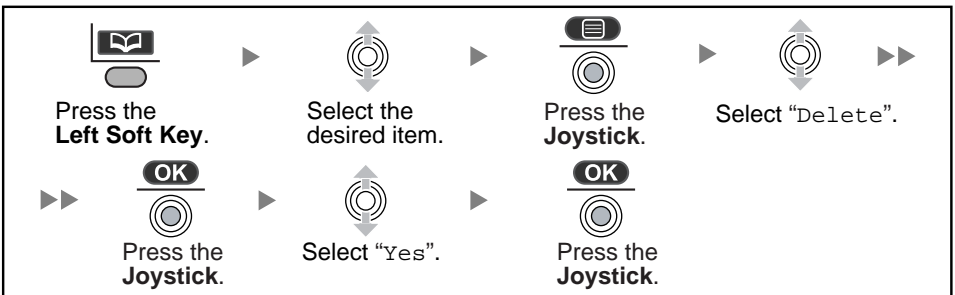

Using the Phonebook

◆ Storing an item in the Handset Phonebook

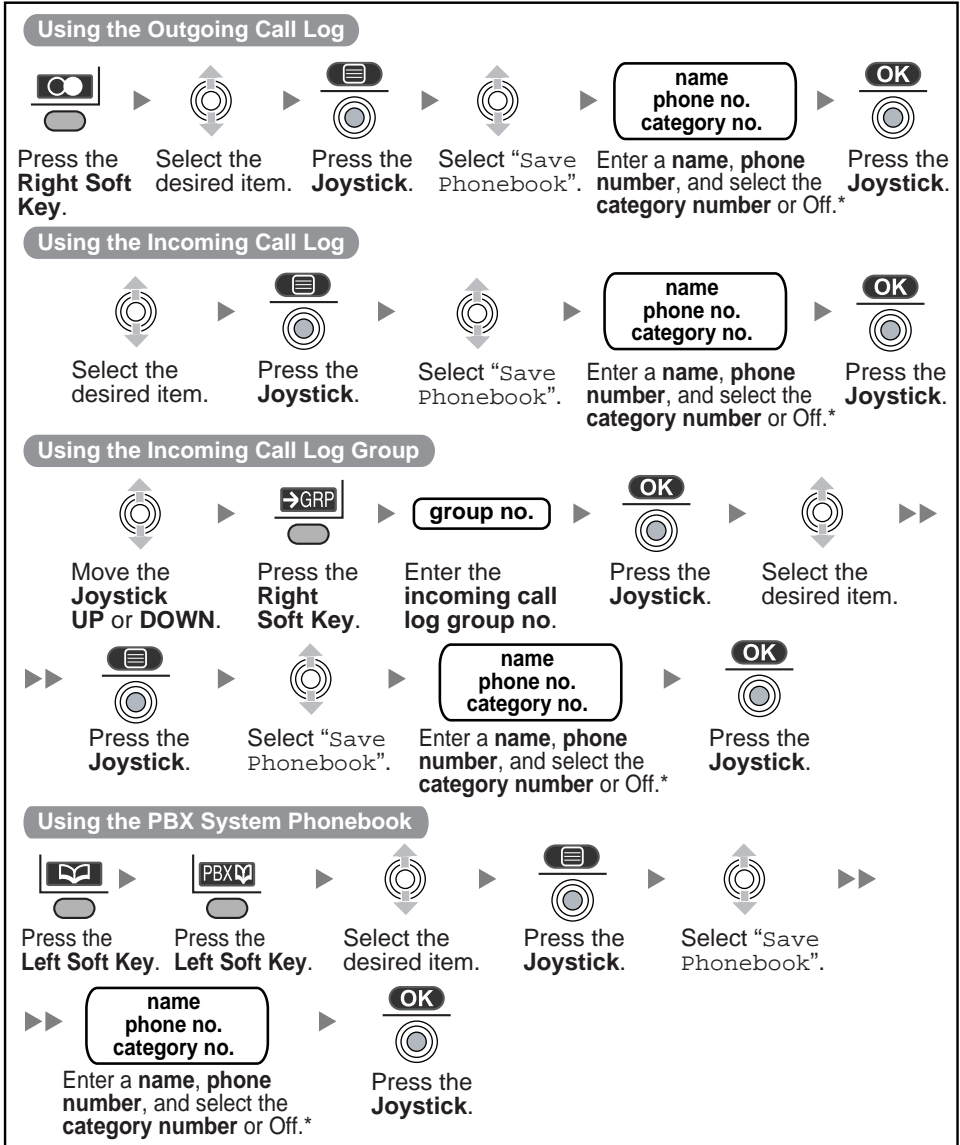

- * Press **OK** to confirm each entries.
- When storing an outside phone number, the line access number will be stored automatically. The line access number must be identical to the PS's "Line Access CD" setting (Call Option). (See page 36.)

Hot Key Dial

The phone numbers stored in the handset phonebook can be assigned as hot key.

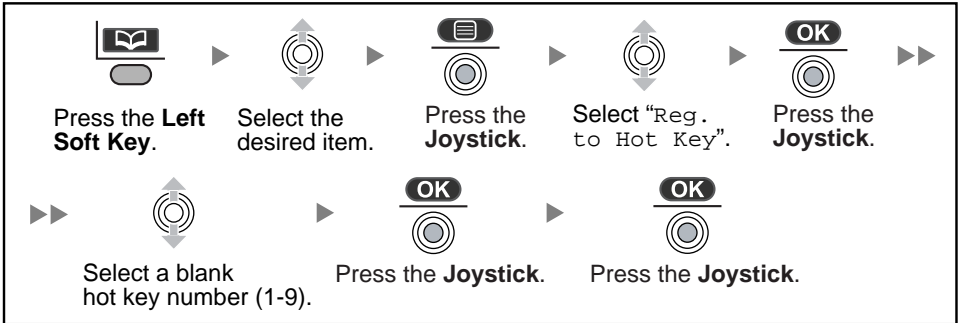

Entering Characters

You can enter characters and digits using the dialling buttons. You can select one of 5 character modes by pressing the **Right Soft Key** while entering a name. The function icon above the soft key displays the current character mode. See "Character Mode Table" (page 28) for available characters.

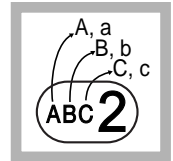



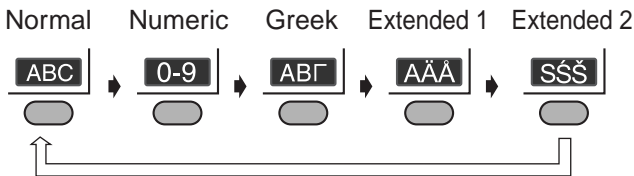

To change the character mode while editing a name in the phonebook, press the **Right Soft Key**.

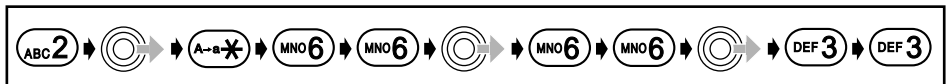

Example: To enter "Anne" in Normal Mode.



- To enter a character located on the same dialling button as the previous character, move the cursor by moving the Joystick , then enter the desired character.
- If you enter a different character by mistake, move the Joystick  to highlight the character, press  to delete it, then enter the correct character.
- To clear an entire line, press and hold .
- To move the cursor, move the Joystick .

Using the Phonebook

◆ Character Mode Table

Buttons	ABC (Alphabet)	0-9 (Numeric)	ABΓ (Greek)	ÄÅ (Extended 1)	ŠŠŠ (Extended 2)
①	Space # & ' () * , - . / 1	1	Space # & ' () * , - . / 1		
②	ABC 2	2	ABΓ 2	Ä Ä Ä Ä Ä Æ B C Ç 2	Š Š Š A B C Č Ć 2
	abc 2				
③	DEF 3	3	Δ EZ 3	D Ě Ě Ě Ě Ě F 3	D Ě Ě Ě Ě Ě F 3
	def 3				
④	GHI 4	4	H O I 4	G Ğ H I I I I I I I I 4	G H I I 4
	ghi 4				
⑤	JKL 5	5	K Λ M 5	g ħ h i i i i i i I I 4	J K L 5
	jkl 5				
⑥	MNO 6	6	N Ξ O 6	M N Ń O Ó Ó Ó Ó Ø ø 6	M N Ń Ń O Ó Ó Ó 6
	mno 6				
⑦	PQRS 7	7	Π Ρ Σ 7	P Q R S Š β 7	P Q R R Ŕ Š Š Š 7
	pqrs 7				
⑧	TUV 8	8	Τ Υ Φ 8	p q r s Š β 7	p q r Ŕ ŕ s š š 7
	tuv 8				
⑨	WXYZ 9	9	Χ Ψ Ω Ϟ 9	T U Ů Ú Ű Ū V 8	T Ť U Ů Ú Ű Ū V 8
	wxyz 9				
⑩	Space 0	0	Space 0	W Ű X Y ŷ Z 9	W X Y ŷ Z Ž ž 9
				w Ű xy ŷ z 9	w xy ŷ z Ž ž 9

• The following letters of Greek, Polish, Czech and Slovakian are not available:

ą ć d'ę Ę ł ł' r'ń Œ ř š š' s' t' w' ŷ ŷ' z' z'

Then same letter as capital (or small) will be displayed.



• Press (⊛) to change between uppercase and lowercase.









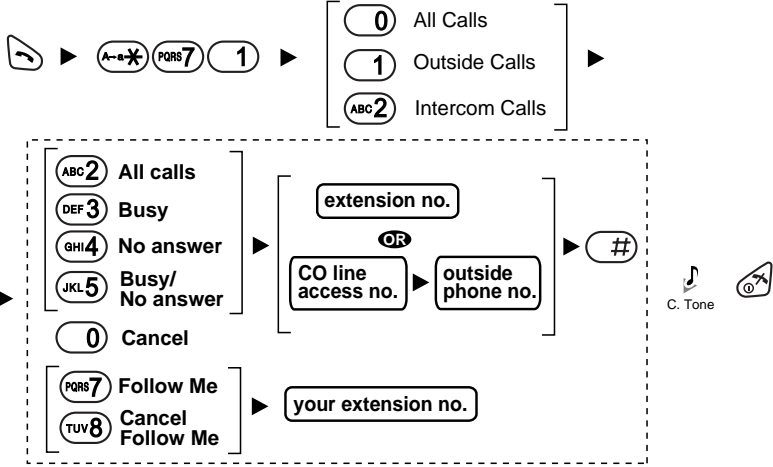
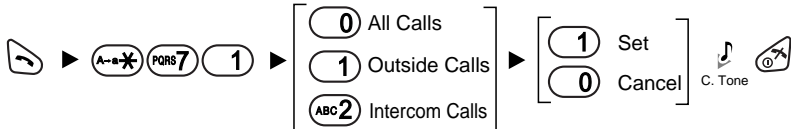









Feature List

C. Tone: Confirmation Tone D. Tone: Dial Tone R.B. Tone: Ringback Tone
 ICD Group: Incoming Call Distribution Group PIN: Personal Identification Number







Feature	Operation
Making Calls	
One-touch Dialling	<p>To store</p>
	<p>To dial</p>
Hot Line	<p>To store</p>
	<p>To set/cancel</p>
	<p>To dial</p>
Operator Call	
System Speed Dialling	<p>To dial</p>
Doorphone Call	
Automatic Callback Busy	<p>To set While hearing a busy tone</p>
	<p>To cancel</p>
Automatic Callback Busy	<p>To answer from an idle extension While hearing a callback ring</p>
	<p>To answer from an idle outside line While hearing a callback ring</p>

Feature List

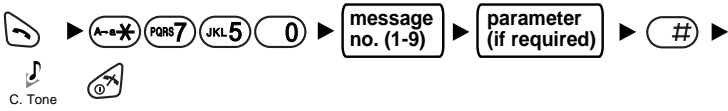
Feature	Operation
During a Conversation	
Multiple Party Conversation	<p>To add another party during a conversation</p>  <p>Talk to the new party.</p> <p>C. Tone</p> <p>Talk with multiple parties.</p>
	<p>To leave a conference</p> 
Useful Features	
Call Forwarding	 <p>C. Tone</p>
Do Not Disturb	 <p>C. Tone</p>

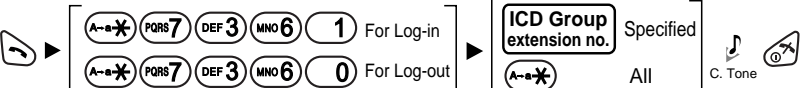
Feature	Operation
Useful Features	
<p>Call Pickup</p>	 <div style="border: 1px dashed black; padding: 5px; display: inline-block;"> <p>Directed A→* GH14 1 ► extension no.</p> <p>Group A→* GH14 0 ► group no. (2 digits)</p> </div>  
<p>Sending a Call Waiting Tone</p>	<p>While hearing a busy tone</p> <p>1 ► Wait for an answer. ► </p>
<p>Call Waiting</p>	<p>To set/cancel for intercom calls</p>  <p>► A→* PQRS7 DEF3 1 ►</p> <div style="display: inline-block; border-left: 1px solid black; border-right: 1px solid black; padding: 0 10px;"> <p>0 No call</p> <p>1 Set</p> </div>  
	<p>To set/cancel for outside calls</p>  <p>► A→* PQRS7 DEF3 ABC2 ►</p> <div style="display: inline-block; border-left: 1px solid black; border-right: 1px solid black; padding: 0 10px;"> <p>0 No tone</p> <p>1 Tone</p> </div>  
	<p>To talk to the second party While hearing a call waiting tone</p>  <p>►</p> <div style="display: inline-block; border-left: 1px solid black; border-right: 1px solid black; border-bottom: 1px solid black; padding: 5px;"> <p>◉ ►</p> <p>OR</p> <p>INT</p> <p>OK</p> </div> <p>► </p>
<p>Paging</p>	<p>To page</p>  <p>► A→* DEF3 DEF3 ► paging group no. (2 digits)</p>   <p>► Announce.</p> <p>► Wait for an answer. ► </p> <hr/> <p>To answer</p>  <p>► A→* GH14 DEF3</p>  

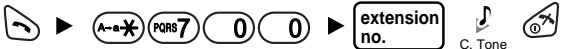
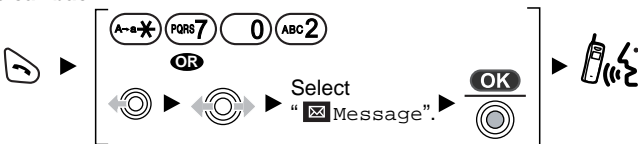
Feature List

Feature	Operation
Useful Features	
Absent Message	<p>To set</p>  <p>To cancel</p> 
Log-in/Log-out	 <p>For Log-in: A-a* PQRS7 DEF3 MNO6 1</p> <p>For Log-out: A-a* PQRS7 DEF3 MNO6 0</p> <p>ICD Group extension no. Specified</p> <p>All: A-a*</p>
Extension Setting Clear	
Message Waiting	<p>Caller</p> <p>To leave a message waiting indication <i>When the called extension is busy or does not answer</i></p> 
	<p>To cancel a message waiting indication</p> 
Called extension	<p>To call back</p> 
Extension Lock*	<p>To lock</p>  <p>To unlock</p> 





* If an extension PIN has not been set for the PS, the extension cannot be locked. (Refer to the Business Telephone System User Manual)

◆◆ Changing the Initial Settings

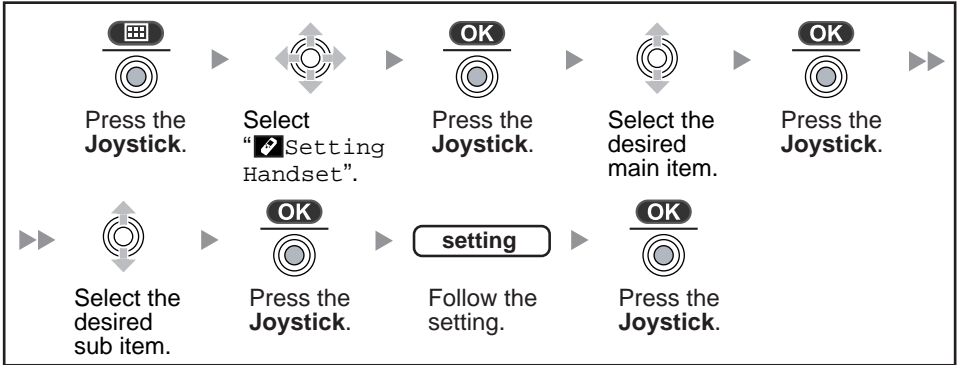
You can customize the handset by editing the settings found under “Setting Handset” in the menu list, as follows:



- To return to the previous menu, press .
- To cancel, press  at any time.
- The unit will beep to indicate that the new settings have been saved.

Programming

◆ Handset setting menu layout

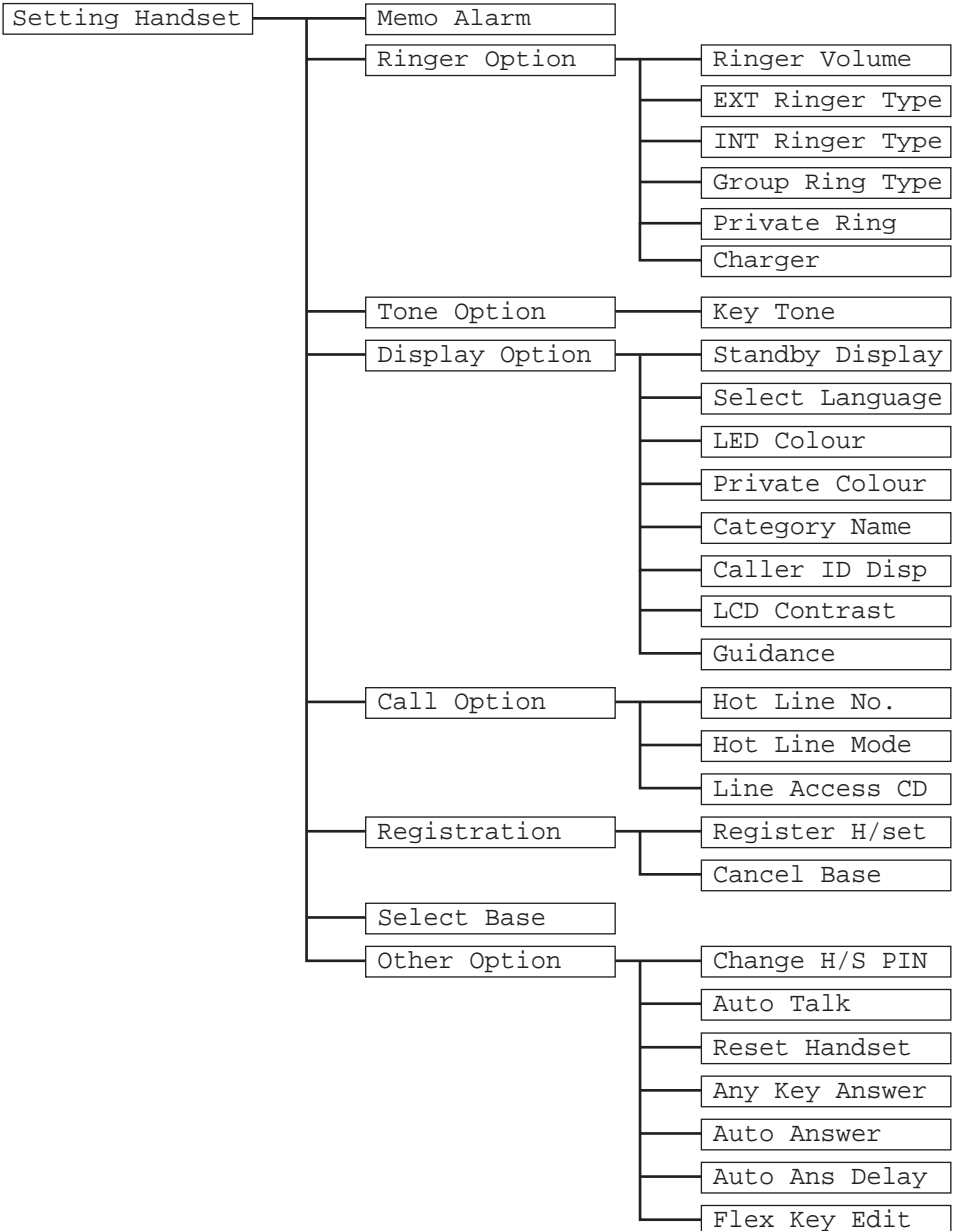

Programming

Main Item	Sub Item	Description	Setting	Default
Memo Alarm		An alarm will sound at the set time. A memo can also be displayed. (See page 38.)	<input type="checkbox"/> Alarm no. <input type="checkbox"/> Alarm mode (Off/Once /Daily) <input type="checkbox"/> Alarm time <input type="checkbox"/> Enter memo. <input type="checkbox"/> 15 Ringer Type	Not Stored
Ringer Option	Ringer Volume	Adjusts the ringer volume.	<input type="checkbox"/> 6 levels/Off	Level 3
	EXT Ringer Type	Selects the ringer type for each type of call. (intercom, outside, and group)	<input type="checkbox"/> 15 Ringer Types	Ringer 1
	INT Ringer Type			
	Group Ring Type			
	Private Ring	Selects the ringer type for calls in each category.	<input type="checkbox"/> Select a Category. <input type="checkbox"/> 15 Ringer Types	
Charger	Selects whether the PS on a charger rings or not.	<input type="checkbox"/> Ringer Setting <input type="checkbox"/> Ringer Off	Ringer Setting	
Tone Option	Key Tone	Turns the key tone off or on.	<input type="checkbox"/> On/Off	On
Display Option	Standby Display	Selects the display in standby mode.	<input type="checkbox"/> 4 Display Type (Base Number/ Handset Number/ Handset Name/ Base & H/S No.) <input type="checkbox"/> Off	Base & H/S No.
	Select Language	Selects the display language.	<input type="checkbox"/> Auto/16 Languages	English
	LED Colour	Selects the LED colour for each type of call. (intercom call, outside call, group call)	<input type="checkbox"/> Call Type (Ext Ring/ Int Ring/ Group Ring) <input type="checkbox"/> Colour (Green/Red/ Orange)	INT Ring-Green, EXT Ring-Red, Group Ring-Orange
	Private Colour	Selects the LED colour for calls in each category. "Private Colour" setting has priority to "LED Colour" setting.	<input type="checkbox"/> Select a Category. <input type="checkbox"/> Colour (Green/Red/ Orange)	Green
	Category Name	Edits the category name.	<input type="checkbox"/> Select a Category.	Category 1-9

Programming

Main Item	Sub Item	Description	Setting	Default
Display Option	Caller ID Disp	Selects which caller information is displayed when a call is received. Either the Handset Phonebook information or the information stored in the Business Telephone System can be displayed.	<input type="checkbox"/> H/S Phonebook/ PBX Setting	PBX Setting
	LCD Contrast	Adjusts the LCD contrast.	<input type="checkbox"/> 3 levels	Level 2
	Guidance	Selects whether the guidance display is shown or not in standby mode.	<input type="checkbox"/> On/Off	On
Call Option	Hot Line No.	Stores a phone number to make a call by pressing TALK.	<input type="checkbox"/> Enter Phone no.	Not stored
	Hot Line Mode	When set to ON, allows you to make a call to the stored phone no. in "Hot Line No." by pressing TALK.	<input type="checkbox"/> On/Off	Off
	Line Access CD	Enters the trunk access code (line access code) that matches the setting of your Business Telephone System. Three trunk access code can be stored.	<input type="checkbox"/> Select a number.+ Enter the code.	No.1 0 No.2 8XX* No.3 Not stored
Registration	Register H/set	Registers a Handset with a base unit.	<input type="checkbox"/> Base no. <input type="checkbox"/> Base PIN [Personal Identification Number]	Not stored
	Cancel Base	Cancels the registration of a handset.	<input type="checkbox"/> H/set PIN (Default: 0000) <input type="checkbox"/> Base no.	Not stored
Select Base		Selects a base unit.	<input type="checkbox"/> Auto/Base no.	
Other Option	Change H/S PIN	Changes the handset PIN.	<input type="checkbox"/> Enter Old PIN.+ Enter New PIN.+ Verify New PIN.	0000
	Auto Talk	When set to ON, allows you to answer a call by just lifting up the handset from the charger.	<input type="checkbox"/> On/Off	On





- * XX is identical to the CO line group number and 8XX represents any 3-digits code starting with "8".

Main Item	Sub Item	Description	Setting	Default
Other Option	Reset Handset	Returns the Handset settings (except Registration) to the default settings.	<input type="checkbox"/> Enter H/set PIN.+Select "Yes".	
	Any Key Answer	When set to ON, allows you to answer a call by pressing any dial button.	<input type="checkbox"/> On/Off	Off
	Auto Answer	Selects the type of calls to be answered by AUTO ANSWER.	<input type="checkbox"/> 2 Call Type (Internal Only/Int&External)/Off	Off
	Auto Ans Delay	Selects the number of seconds before a call is automatically answered when Auto Answer is turned on.	<input type="checkbox"/> 5-20 sec.	6 sec
	Flex Key Edit	Allows you to assign a function to a flexible key, and use the key as a shortcut key.	<input type="checkbox"/> See page 39.	

Programming

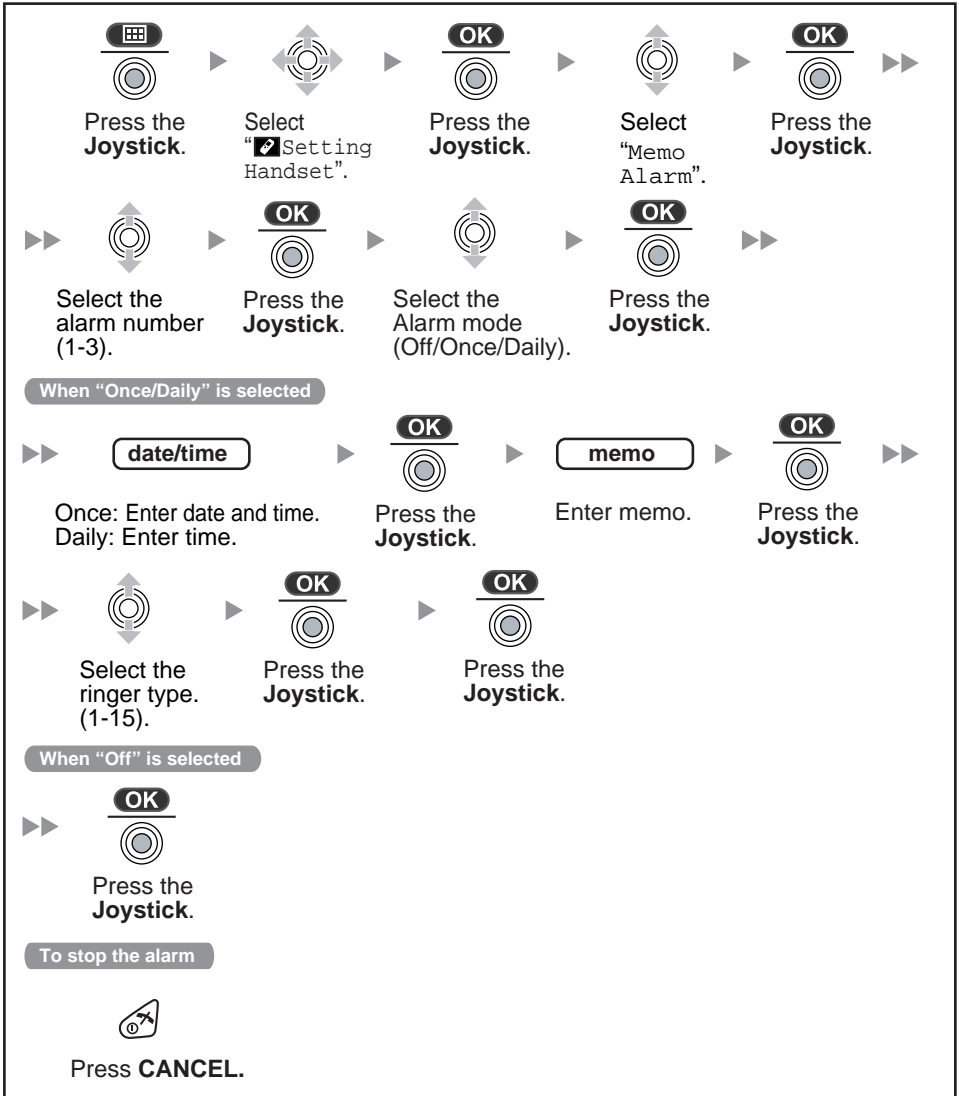
◆ Memo alarm setting



- To clear the displayed memo alarm, press  and then select "Yes".
- During a conversation, an alarm will not sound until the call is ended.

◆ Flexible key edit

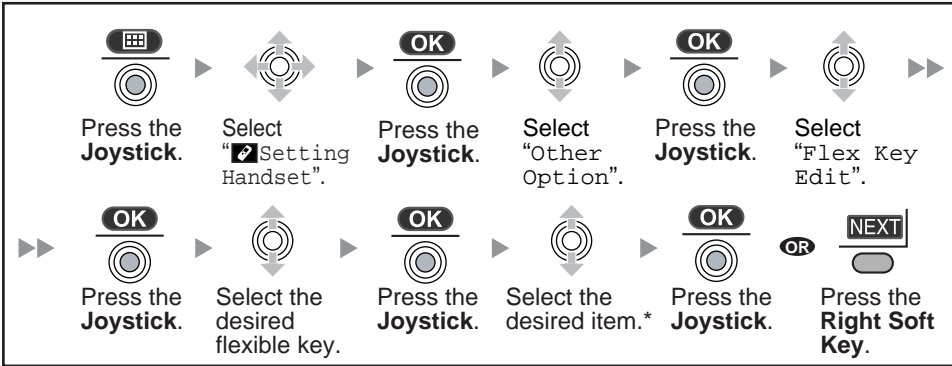

- * Items on page 40 can be assigned, and accessed through the display operation.
- To assign an item other than "PBX setting" to a flexible key which has already been used, first set the key to "Not stored", as shown below.

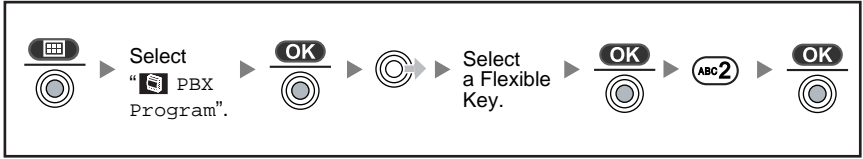

Programming

Main Item	Sub-Items			
PBX setting				
Menu	Caller ID			
	Ringer Option	Ringer Volume EXT Ringer Type INT Ringer Type Group Ring Type Private Ring Charger		
	New Phonebook			
	Setting Handset	Memo Alarm		
		Ringer Option	Ringer Volume EXT Ringer Type INT Ringer Type Group Ring Type Private Ring Charger	
		Tone Option	Key Tone	
		Display Option	Standby Display Select Language LED Colour Private Colour Category Name Caller ID Disp LCD Contrast Guidance	
		Call Option	Hot Line No. Hot Line Mode Line Access CD	
		Registration		
		Select Base		
Other Option	Change H/S PIN Auto Talk Reset Handset Any Key Answer Auto Answer Auto Ans Delay Flex Key Edit			
PBX Program				
Walkie-Talkie				
Dialing	H/set Phonebook PBX Sys Dialing PBX EXT Dialing			
Call log	Redial Incoming Log Incoming LogGrp			



• To access sub-items, press **NEXT**.



◆◆ Walkie-Talkie

Using Walkie-Talkie mode, you can communicate with another handset even when out of range of a base unit. Only Panasonic DECT Portable Station which supports Walkie-Talkie can be used. Handsets have to be in Walkie-Talkie mode, and have the same Walkie-Talkie group number. In Walkie-Talkie mode, you cannot make or receive a call through the PBX.

◆ Turning the Walkie-Talkie mode on

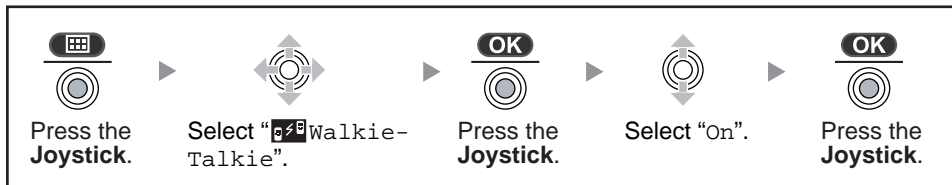

◆ Turning the Walkie-Talkie mode off



- To exit the operation, press  any time.
- When the Walkie-Talkie mode is ON, the handset number is displayed followed by "Walkie-Talkie".

◆ Setting the Walkie-Talkie mode

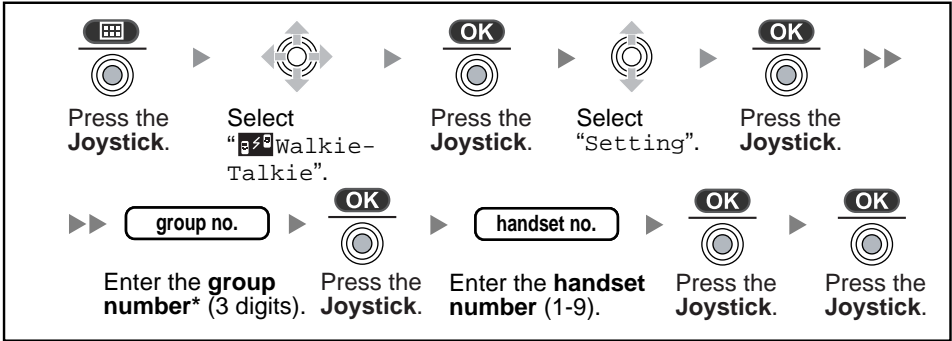

- To exit the operation, press any time.
- * Any combination of three number can be used, make note of your own code.
- Each handset should have its own unique number.

◆ Talking in Walkie-Talkie mode

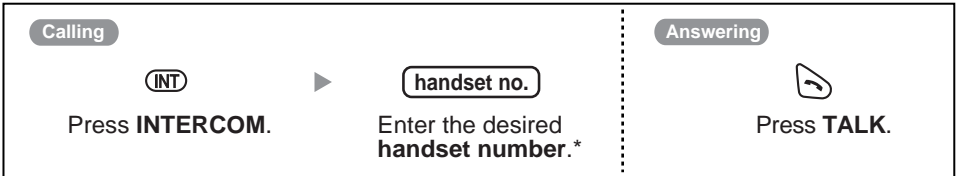

- To exit the operation, press any time.
- * A caller can press to call all handsets in the same Walkie-Talkie mode.

◆◆ Using the Belt Clip

You can hang the handset on your belt.

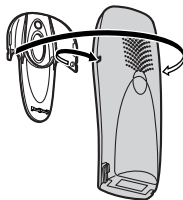

To remove the belt clip.



◆◆ **Wall Mounting**

- 1 Connect the AC adaptor to the charger.
- 2 Drive the screws into the wall using the wall template below.

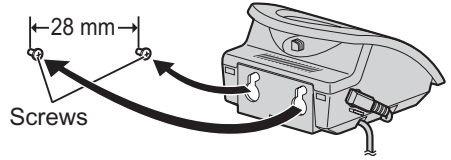
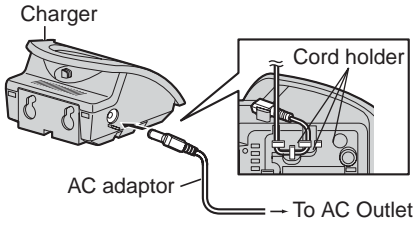

- 3 Mount the charger securely on the screws.

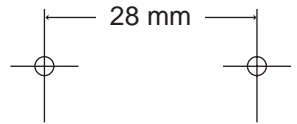

Troubleshooting

◆◆ Troubleshooting

Problem	Description and Solution
The PS does not work.	<ul style="list-style-type: none"> • The battery is drained. → Charge the battery fully. (See “Battery Charge” on page 7.) • The PS has been cancelled or the PS has not been registered. → Consult your dealer. • The power is OFF. → Turn it ON. (See “Power On/Off” on page 8.)
The PS does not ring.	<ul style="list-style-type: none"> • Ringer volume is set to “OFF”. → Adjust the ringer volume level. (See “Ringer Volume Adjustment” on page 13.)
You cannot make/receive a call.	<ul style="list-style-type: none"> • The PS is out of range or the Cell Station (CS) is busy. → Move closer to the CS or try again later. • The radio channel is busy or a radio communication error occurred. → Try again later.
You cannot dial.	<ul style="list-style-type: none"> • The number which you dialled is restricted by the Business Telephone System. → Consult your dealer. • The key lock mode is ON. → To cancel the mode, press the Joystick for about 2 seconds. (See “Key Lock” on page 13.) • The radio channel is busy or a radio communication error occurred. → Try again later.
Noise is frequently heard.	<ul style="list-style-type: none"> → Set the PS and CS away from other electrical appliances. → Move closer to the CS.
“CS BUSY” is displayed.	<ul style="list-style-type: none"> • When the Cell Station is busy, the PS will sound a search tone. If the PS does not find an available Cell Station, a busy tone will be heard. → Try again later.
“PS Not Connected” is displayed.	<ul style="list-style-type: none"> • The called PS is out of range or the PS is power off. → Try again later.
The PS stops working during operation.	<ul style="list-style-type: none"> → Turn the power OFF and ON, then try again. (See “Power On/Off” on page 8.) → Reinsert the batteries and try again. (See “Battery Installation” on page 7.)

◆◆ Battery Information

After your Panasonic batteries are fully charged [at 25 °C]:

Operation	Operating Time
While in use (TALK)	10 hrs approx.
While not in use (Standby)	120 hrs approx.

- Battery charge may be shortened depending on usage conditions and ambient temperature.
- The batteries cannot be overcharged.
- The batteries will drain even while the unit is "OFF".
- The PS can receive calls while charging.
- Battery consumption increases when the PS is used out of range. If "Υ" flashes, power off the PS.
- **Clean the handset and the charger contacts with a soft, dry cloth once a month. Clean more often if the unit is subject to grease, dust or high humidity.** Otherwise the batteries may not charge properly.
- Read "Important Notice Concerning the Correct Use and Charging of Ni-MH Batteries."

◆ Low Battery Warning

The batteries need to be charged when "☐" flashes or the alarm sounds every one minute.*

* If the low battery warning occurs during a conversation, you can continue the call for one minute, then the call will be disconnected automatically.

◆ Replacing the Batteries

If "☐" flashes after a few telephone calls even when the batteries have been fully charged, it is time to replace the batteries with new ones.

Before replacing the batteries, turn the power off to prevent memory loss. Replace the batteries. Charge the new batteries for at least 7 hours.

If you replace the batteries before the low battery warning appears, the battery strength icon may display an incorrect reading. In this case, use the PS as normal with the new batteries installed. When the low battery warning is displayed, charge the batteries for about 7 hours.

The battery strength icon will then display a correct reading.

- Please replace with PANASONIC batteries, part number HHR-4EPT/BA2.
- Replace both batteries and close the cover then charge the handset for about 7 hours.



Please use only Panasonic R03P (Ni-MH) batteries, part number HHR-4EPT/BA2.

Important Information

◆ **Caution**

To reduce the risk of fire or injury to persons, read and follow these instructions.

- 1) Use only the batteries specified.
- 2) Do not use non-rechargeable batteries.
- 3) Do not mix old and new batteries.
- 4) Do not dispose of the batteries in a fire. They may explode. Check with local waste management codes for special disposal instructions.
- 5) Do not open or mutilate the batteries. Released electrolyte is corrosive and may cause burns or injury to the eyes or skin. The electrolyte may be toxic if swallowed.
- 6) Exercise care in handling the batteries in order not to short the batteries with conductive materials such as rings, bracelets, and keys. The batteries and/or conductor may overheat and cause burns.
- 7) Charge the batteries provided with or identified for use with this product only in accordance with the instructions and limitations specified in this manual.

◆ **Important Notice Concerning the Correct Use and Charging of Ni-MH Batteries**

Batteries, due to their construction, undergo some wear and tear. The lifetime of a battery also depends on correct maintenance. Charging and discharging are the most important factors. You should take notice of the following to maintain the life of the battery as long as possible.

Ni-MH batteries have a kind of memory, the “memory effect.” If fully charged batteries are used several times only for 15 minutes in the handset and then recharged, the capacity of the batteries will be reduced to 15 minutes due to the memory effect. Therefore you should discharge the batteries completely, i.e. use them in the handset until “” on the display starts flashing. Then recharge them as described in the manual. After the memory effect has occurred, it is possible to achieve almost complete capacity of the Ni-MH batteries by charging and discharging several times one after another.

Ni-MH batteries can also self-discharge. This self-discharge depends on the ambient temperature. At temperatures under 0 °C, the self-discharge will be the lowest. High humidity and high temperatures support the self-discharge. Also long-term storage will lead to self-discharge. A dead Ni-MH battery should not be disposed of normally. They contain toxic heavy metal hydride and therefore should be recycled.

◆◆ **Safety Instructions**

Pay special attention to the safety suggestions listed below.

◆ **Safety**

- 1) Power source: The AC adaptor should be connected to a power supply only of the type as marked on the AC adaptor. The AC adaptor is used as the main disconnect device, ensure that the AC outlet is located/installed near the unit and is easily accessible.

- 2) Non use periods: When the PS is not being used, turn the power off. When left unused for a long period of time, the charger should be unplugged from the AC outlet.
- 3) Do not place metal items such as coins or rings on the charger. As they become hot, you might get burned if you touch them.

◆ **Installation**

Environment

- 1) Water and moisture: Do not use the PS and the charger near water — for example, near a bathtub, washbowl, sink, etc. Damp basements should also be avoided.
- 2) Heat: The PS and the charger should be kept away from heat sources such as radiators, kitchen ranges, etc. They also should not be placed in rooms where the temperature is less than 5 °C or greater than 40 °C.

Placement

- 1) Stacking: Do not place heavy objects on top of the PS and charger.
- 2) Foreign material: Care should be taken so that objects do not fall onto and liquids are not spilled into the PS and charger. Do not subject the PS and charger to excessive smoke, dust, mechanical vibration, or shock.
- 3) Surface: Place the charger on a flat surface. If the charger is mounted on the wall, install it straight.

◆ **For best performance**

Operating Range

- 1) The range of operation depends on the topography of your office, weather or usage conditions, because signals are transmitted between the Cell Station (CS) and the PS by radio waves.
- 2) Normally, you get greater range outdoors than indoors. If there are obstacles such as walls, noise may interfere with your telephone calls. In particular, high metal shelves or reinforced concrete walls will restrict your operating range.
- 3) A PS may not work when it is too far from the CS depending on the structure of the building.

Noise

Occasional noise or interference may occur due to electromagnetic radiation from objects such as refrigerators, microwave ovens, faxes, TVs, radios, or personal computers. If noise disturbs your telephone calls, keep the PS away from these electrical appliances.

WARNING:

TO PREVENT FIRE OR SHOCK HAZARD, DO NOT EXPOSE THIS PRODUCT TO RAIN OR ANY TYPE OF MOISTURE. TO REDUCE THE RISK OF ELECTRIC SHOCK, DO NOT DISASSEMBLE THIS UNIT. TAKE THE UNIT TO AN AUTHORISED SERVICE CENTRE WHEN SERVICE IS REQUIRED.

Important Information

◆ RF Specifications

Item	Description
Radio Access Method	Multi Carrier TDMA-TDD
Frequency Band	1,880 MHz - 1,900 MHz
Number of Carriers	10
Carrier Spacing	1,728 kHz
Bit Rate	1,152 kbps
Carrier Multiplex	TDMA, 24 (TA×12, RA×12) slots per frame
Frame Length	10 ms
Modulation	GFSK
Voice Coding	32 kbps ADPCM (CCITT G.721)
Transmission Output	Max. 250 mW

- Specifications are subject to change.
- The illustrations used in this manual may slightly differ from the original device.

The following regulations are applied to the KX-TCA155E users only:

- 999 and 112 can be dialled on the apparatus after accessing the CO line for the purpose of making outgoing calls to the BT emergency (999) and (112) services.
- The apparatus is designed to be installed and operated under controlled conditions of ambient temperature and a relative humidity.
- Avoid installing the apparatus in damp or humid environments, such as in bathrooms or near swimming pools.
- This apparatus is designed to aid the visually handicapped to locate dial keys and buttons.

CE 0436

This device is a DECT Portable station operating in the frequency band of 1,880 MHz to 1,900 MHz. The usage of this device is generally allowed in all the EU countries.

We, Panasonic Communications Company (U.K.) Ltd., declare that this equipment is in compliance with the essential requirements and other relevant provisions of Directive 1999/5/EC. If you want to get a copy of the original Declaration of Conformity of our products which relates to the R&TTE, please contact to our web address:

<http://doc.panasonic-tc.de>

Copyright:

This manual is copyrighted by Panasonic Communications Co., Ltd. (PCC). You may print out this manual solely for internal use with this model. Except above, you may not reproduce this manual in any form, in whole or part, without the prior written consent of PCC and its licensee.

© 2003 Panasonic Communications Co., Ltd. All Rights Reserved.

Panasonic Communications Company (U.K.) Ltd.

Pencarn Way, Duffryn, Newport, South Wales, NP10 8YE, United Kingdom

PSQX2983ZA KK0703TT0