

TECHNICAL & SERVICE MANUAL

CS-KS18NKU + CU-KS18NKU
+ CU-KS18NKUA

CS-KS24NKU + CU-KS24NKU
+ CU-KS24NKUA

DC INVERTER SPLIT SYSTEM AIR CONDITIONER

Indoor Model No.	Product Code No.
CS-KS18NKU	1 852 360 90
CS-KS24NKU	1 852 360 91

Outdoor Model No.	Product Code No.
CU-KS18NKU	1 852 361 18
CU-KS18NKUA	1 852 361 19
CU-KS24NKU	1 852 361 21
CU-KS24NKUA	1 852 361 22

Indoor Unit

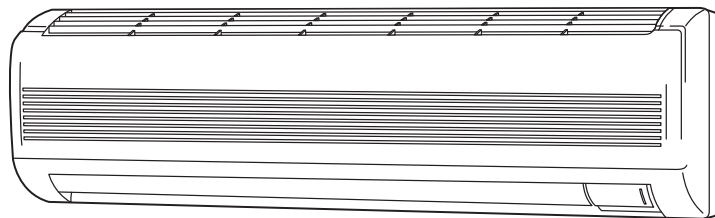

CS-KS18NKU
CS-KS24NKU



Outdoor Unit

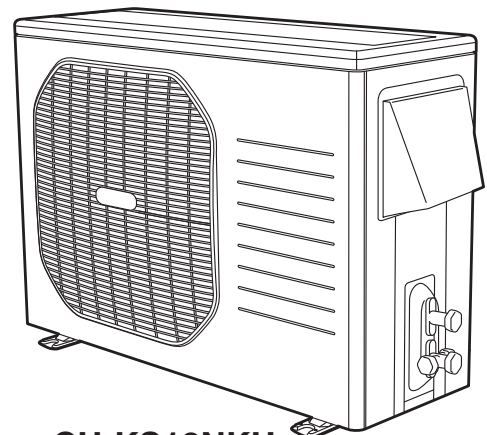

CU-KS18NKU
CU-KS18NKUA

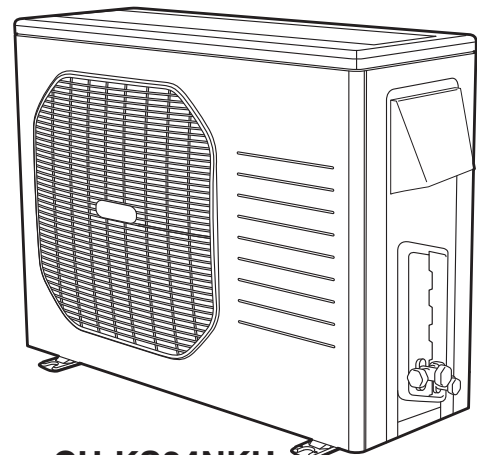

CU-KS24NKU
CU-KS24NKUA









IMPORTANT















These air conditioners employ new refrigerant R410A.









Pay special attention when servicing the unit.

R410A

SAFETY PRECAUTIONS

- Before doing repair work, please read the " SAFETY PRECAUTIONS" carefully and fully understand them.
- The precautionary items here are divided into " Warning" and " Caution" items.
Items in particular which may cause death or serious injury to the service personnel if the work is not performed correctly, are included in the " Warning" table.
However, even precautionary items identified as " Caution" also have the potential for serious consequences if not performed correctly.
Important safety precautions are described for all items in both categories. Be sure to carefully follow all of them.
- Symbol Indication
 -  : This symbol indicates items to which we need to pay attention.
In this triangle, a definite precautionary item is described.
 -  : This symbol indicates the item to be prohibited.
In or close to this circle, a prohibited item is described.
 -  : This symbol indicates the items requiring special attention or instruction.
In or close to this circle, a prohibited item is described.
- After doing repair work, perform a test run to confirm that there are no abnormalities.
At the same time, explain the precautions in use to the user.

 Warning	
Before performing an overhaul, disconnect the power plug or power cable from the unit. Performing the work with the power supplied to the unit, may cause an electric shock.	
When repair work or circuit inspection that requires power supply for the air conditioner, is to be performed, do not touch the charging section. Doing so may cause an electric shock.	 Prohibit
For the step-up capacitor attached to the electric section, perform the repair work after sufficiently discharging it. Insufficient capacitor discharge may cause an electric shock.	
Do not perform repair work on the electric sections with wet hands. Doing so may cause an electric shock.	 Prohibit
Do not start or stop the air conditioner by means of connecting or disconnecting the power plug. Doing so may cause an electric shock or fire.	 Prohibit
When conducting repair work only use components included in the parts list for the corresponding unit and perform the work with the appropriate tools. Incorrect or poor repair work may cause an electric shock or fire.	
Never modify the unit. Doing so may cause an electric shock or fire.	 Prohibit
Perform all electric work according to local applicable regulations related to electrical equipment or interior wiring regulation and make sure to use the exclusive circuit. Insufficient capacity to the electric circuit or defective arrangement results may cause an electric shock or fire.	
Make sure to replace any power cable or lead wire showing any signs of scratch or deterioration. Failure to do so may cause an electric shock, overheating or fire.	
Make sure that there is no dust on or slack in the power plug and insert fully into the socket. Dust or incomplete connections may cause an electric shock or fire.	
Do not damage or process the power cord, as it may cause an electric shock or fire.	 Prohibit
For the wiring between the indoor unit and outdoor unit, securely fix the specified cable onto the terminal plate. Poorly fixed wiring may cause a heat or fire.	
After connecting the wiring between the indoor unit and outdoor unit, attach the terminal cover securely. Incomplete attachment of the terminal cover may cause overheating or fire.	

 Warning	
If refrigerant gas blows off during the work, do not touch the refrigerant gas as it may cause frostbite.	 Prohibit
If refrigerant gas leaks during the work, ventilate the room. If refrigerant gas catches fire, harmful gas may be generated.	
Do not mix any gas other than the specified refrigerant gas in the refrigerating cycle. If air or other contaminants mix with the gas, pressure will become extremely high in the refrigerating cycle, which may cause a unit breakdown."	 Prohibit
When the welded section of the compressor intake or discharge pipe is to be disconnected, perform it in a well-ventilated place after sufficiently recovering the refrigerant gas. Any residue gas may jet out refrigerant or refrigerating machine oil, which may cause an injury.	
When the work is to be performed in a high place (About 2 meters or more), make sure to wear a safety helmet, gloves and safety belt. Insufficient safety gear may cause a serious injury in case of a fall.	
When the unit is to be relocated, confirm that the new installation location has sufficient strength for the weight of the unit. Insufficient strength of the installation location and incomplete installation work may cause an injury due to the unit falling.	
When the remote controller batteries are replaced, dispose of the old batteries out of the reach of children. If a child swallows a battery, make sure that the child gets immediate medical attention.	













 Caution	
Do not wash the air conditioner with water, as this may cause an electric shock or fire.	 Prohibit
For the repair work in places with high humidity or moisture, make sure to ground the unit. Failure to do so may cause an electric shock.	
Confirm that the component attachment position, wiring condition, soldering condition and connector connection are normal. If not, it may cause overheating or fire.	
Confirm that the temperature around the compressor is not too high, and then perform the repair work. Failure to do so may cause a burn.	
Perform welding work in a place with good ventilation. If the work is performed in a poorly ventilated area, it might cause a lack of oxygen.	
If the installation plate or attachment frame has deteriorated due to corrosion, etc., replace it. Failure to do so may cause an injury due to the unit falling.	
When the cleaning is to be performed, make sure to turn off the power and pull out the plug. Touching the fan that is rotating at high speed may result in an injury.	
When the indoor unit is to be removed, do not place it on an incline. Doing so may cause wet furniture because water left inside may trickle down.	 Prohibit
Do not hold the sharp end of the unit or the aluminum fins, as it may cause an injury to your hand or finger.	 Prohibit
After repairs, make sure to measure the insulation resistance and confirm that the value is 1 Mohm or more. Any insulation error may cause an electric shock.	
After repairs, make sure to check the drainage of the indoor unit. Inappropriate drainage may cause wet furniture and floors due to water leakage.	

Table of Contents

	Page
1. OPERATING RANGE	6
2. SPECIFICATIONS	
2-1. Unit Specifications	7
2-2. Major Component Specifications	15
2-3. Other Component Specifications	21
3. DIMENSIONAL DATA	22
4. REFRIGERANT FLOW DIAGRAM	
4-1. Refrigerant Flow Diagram	25
5. PERFORMANCE DATA	
5-1. Temperature Charts	26
5-2. Cooling Capacity	30
5-3. Cooling Capacity (Low Ambient)	32
5-4. Air Throw Distance Charts	34
6. ELECTRICAL DATA	
6-1. Electrical Characteristics	36
6-2. Electric Wiring Diagrams	38
7. MAINTENANCE	
7-1. Address Setting of the Remote Control Unit	42
7-2. Disconnecting and Connecting Positive Connector for Outdoor Unit	43
8. FUNCTIONS	
8-1. Operation Functions	44
8-2. Protective Functions	46
9. TROUBLESHOOTING (BEFORE CALLING FOR SERVICE)	
9-1. Precautions before Performing Inspection or Repair	47
9-2. Method of Self-Diagnostics	47
9-3. Checking the Indoor and Outdoor Units	50
9-4. Trouble Diagnosis of Fan Motor	54
9-5. Noise Malfunction and Electromagnetic Interference	56
10. CHECKING ELECTRICAL COMPONENTS	
10-1. Measurement of Insulation Resistance	57
10-2. Checking Continuity of Fuse on PCB Ass'y	58

11. REFRIGERANT R410A:

SPECIAL PRECAUTIONS WHEN SERVICING UNIT

- 11-1. Characteristics of New Refrigerant R410A 59
- 11-2. Checklist before Servicing 60
- 11-3. Tools Specifically for R410A 61
- 11-4. Tubing Installation Procedures 61
- 11-5. In Case of Compressor Malfunction 62
- 11-6. In Case Refrigerant is Leaking 64
- 11-7. Charging Additional Refrigerant 65
- 11-8. Retro-Fitting Existing Systems 65

- APPENDIX A** Operating Instructions A-1

- APPENDIX B** INSTALLATION INSTRUCTIONS A-2

1. OPERATING RANGE

**Models : CS-KS18NKU + CU-KS18NKU
CS-KS24NKU + CU-KS24NKU**

	Temperature	Indoor Air Intake Temp.	Outdoor Air Intake Temp.
Cooling	Maximum	95 °F DB / 71 °F WB	115 °F DB
	Minimum	67 °F DB / 57 °F WB	67 °F DB

**Models : CS-KS18NKU + CU-KS18NKUA
CS-KS24NKU + CU-KS24NKUA**

	Temperature	Indoor Air Intake Temp.	Outdoor Air Intake Temp.
Cooling	Maximum	95 °F DB / 71 °F WB	115 °F DB
	Minimum	67 °F DB / 57 °F WB	0 °F DB

2. SPECIFICATIONS

2-1. Unit Specifications

Indoor Unit **CS-KS18NKU**

Outdoor Unit **CU-KS18NKU**

< 230V >

Voltage Rating		230V Single-Phase 60Hz		
Performance			Cooling	
	Total Capacity	BTU/h kW	17,500 (4,000 to 17,500) 5.15 (1.2 to 5.15)	
	Sensible Capacity	BTU/h	13,100	
	Latent Capacity	BTU/h	4,400	
	Air Circulation (Hi/Me/Lo)	ft ³ /min (m ³ /h)	524 (890) / 441 (749) / 377 (641)	
	Moisture Removal (High)	Pints/h	4.89	
Electrical Rating	Available Voltage Range	V	187 to 253	
	Running Amperes	A	7.0 (1.2 to 7.0)	
	Power Input	W	1,500 (250 to 1,500)	
	Power Factor	%	93	
	EER	BTU/h/W	11.7	
	SEER	BTU/Wh	20	
	Compressor Locked Rotor Amperes	A	17.5	
	Fuse or Circuit Breaker Capacity	A	15	
Features	Controls / Temperature Control		Microprocessor / I.C. Thermistor	
	Control Unit		Wireless Remote Control Unit	
	Timer		24-Hour ON or OFF Timer, 1-Hour OFF Timer	
	Fan Speeds	Indoor / Outdoor	Auto and 3 steps / Auto (Hi, Me, Lo)	
	Airflow Direction (Indoor)	Horizontal Vertical	Manual Auto	
	Air Filter		Washable, Anti-Mold	
	Compressor		DC Twin Rotary (Inverter)	
	Refrigerant / Amount charged at shipment	lbs (g)	R410A / 2.87 (1,300)	
	Refrigerant Control		Electric Expansion Valve	
	Operation Sound	Indoor : Hi/Me/Lo/Qt* dB-A	42 / 38 / 30 / 28	
	(*Qt = Quiet mode)	Outdoor : Hi dB-A	51	
	Refrigerant Tubing Connections		Flare Type	
	Max. allowable tubing length at shipment	ft (m)	25 (7.5)	
	Refrigerant	Narrow tube inch (mm)	1/4 (6.35)	
	Tube Diameter	Wide tube inch (mm)	1/2 (12.7)	
Refrigerant Tube Kit		Optional		
Dimensions & Weight			Indoor Unit	Outdoor Unit
	Unit Dimensions	inch	11-23/32 × 41-15/16 × 8-5/8	26-3/8 × 34-21/32 × 11-7/32
	Height × Width × Depth	(mm)	(298 × 1,065 × 219)	(670 × 880 × 285)
	Package Dimensions	inch	11-27/32 × 45-1/8 × 15-5/32	28-27/32 × 39-27/32 × 14-29/32
	Height × Width × Depth	(mm)	(301 × 1,146 × 385)	(733 × 1,012 × 379)
	Weight	Net	lbs (kg)	26.5 (12.0)
	Shipping	lbs (kg)	33.1 (15.0)	99.2 (45.0)
Shipping Volume		cu.ft (m ³)	4.59 (0.13)	9.88 (0.28)

DATA SUBJECT TO CHANGE WITHOUT NOTICE.

Remarks: Rating conditions are:

Cooling: Indoor air temperature 80 °F DB / 67 °F WB

Outdoor air temperature 95 °F DB / 75 °F WB

Indoor Unit **CS-KS18NKU**
 Outdoor Unit **CU-KS18NKU**

< 208V >

Voltage Rating		208V Single-Phase 60Hz	
Performance			Cooling
	Total Capacity	BTU/h	17,500 (4,000 to 17,500)
		kW	5.15 (1.2 to 5.15)
	Sensible Capacity	BTU/h	13,100
	Latent Capacity	BTU/h	4,400
	Air Circulation (Hi/Me/Lo)	ft ³ /min (m ³ /h)	524 (890) / 441 (749) / 377 (641)
	Moisture Removal (High)	Pints/h	4.89
Electrical Rating	Available Voltage Range	V	187 to 253
	Running Amperes	A	7.7 (1.2 to 7.7)
	Power Input	W	1,500 (250 to 1,500)
	Power Factor	%	94
	EER	BTU/h/W	11.7
	SEER	BTU/Wh	20
	Compressor Locked Rotor Amperes	A	17.5
	Fuse or Circuit Breaker Capacity	A	15
Features	Controls / Temperature Control		Microprocessor / I.C. Thermistor
	Control Unit		Wireless Remote Control Unit
	Timer		24-Hour ON or OFF Timer, 1-Hour OFF Timer
	Fan Speeds	Indoor / Outdoor	Auto and 3 steps / Auto (Hi, Me, Lo)
	Airflow Direction (Indoor)	Horizontal	Manual
		Vertical	Auto
	Air Filter		Washable, Anti-Mold
	Compressor		DC Twin Rotary (Inverter)
	Refrigerant / Amount charged at shipment	lbs (g)	R410A / 2.87 (1,300)
	Refrigerant Control		Electric Expansion Valve
	Operation Sound	Indoor : Hi/Me/Lo/Qt*	dB-A 42 / 38 / 30 / 28
	(*Qt = Quiet mode)	Outdoor : Hi	
	Refrigerant Tubing Connections		Flare Type
	Max. allowable tubing length at shipment	ft (m)	25 (7.5)
	Refrigerant	Narrow tube	inch (mm)
Tube Diameter	Wide tube	inch (mm)	1/2 (12.7)
Refrigerant Tube Kit		Optional	
Dimensions & Weight			Indoor Unit
	Unit Dimensions	inch	11-23/32 × 41-15/16 × 8-5/8
	Height × Width × Depth	(mm)	(298 × 1,065 × 219)
	Package Dimensions	inch	28-27/32 × 39-27/32 × 14-29/32
	Height × Width × Depth	(mm)	(733 × 1,012 × 379)
	Weight	Net	lbs (kg)
Shipping		lbs (kg)	33.1 (15.0)
Shipping Volume		cu.ft (m ³)	9.88 (0.28)

DATA SUBJECT TO CHANGE WITHOUT NOTICE.

Remarks: Rating conditions are:

Cooling: Indoor air temperature 80 °F DB / 67 °F WB

Outdoor air temperature 95 °F DB / 75 °F WB

Indoor Unit **CS-KS24NKU**
 Outdoor Unit **CU-KS24NKU**

< 230V >

Voltage Rating		230V Single-Phase 60Hz		
Performance			Cooling	
	Total Capacity	BTU/h kW	24,200 (4,000 to 24,200) 7.1 (1.2 to 7.1)	
	Sensible Capacity	BTU/h	14,800	
	Latent Capacity	BTU/h	9,400	
	Air Circulation (Hi/Me/Lo)	ft ³ /min (m ³ /h)	659 (1,120) / 571 (970) / 494 (839)	
	Moisture Removal (High)	Pints/h	4.89	
Electrical Rating	Available Voltage Range	V	187 to 253	
	Running Amperes	A	10.8 (1.3 to 10.8)	
	Power Input	W	2,460 (280 to 2,460)	
	Power Factor	%	99	
	EER	BTU/h/W	9.8	
	SEER	BTU/Wh	17	
	Compressor Locked Rotor Amperes	A	17.5	
	Fuse or Circuit Breaker Capacity	A	20	
Features	Controls / Temperature Control		Microprocessor / I.C. Thermistor	
	Control Unit		Wireless Remote Control Unit	
	Timer		24-Hour ON or OFF Timer, 1-Hour OFF Timer	
	Fan Speeds	Indoor / Outdoor	Auto and 3 steps / Auto (Hi, Me, Lo)	
	Airflow Direction (Indoor)	Horizontal	Manual	
		Vertical	Auto	
	Air Filter		Washable, Anti-Mold	
	Compressor		DC Twin Rotary (Inverter)	
	Refrigerant / Amount charged at shipment	lbs (g)	R410A / 4.30 (1,950)	
	Refrigerant Control		Electric Expansion Valve	
	Operation Sound	Indoor : Hi/Me/Lo/Qt*	dB-A	47 / 44 / 41 / 30
		Outdoor : Hi		
	Refrigerant Tubing Connections		Flare Type	
	Max. allowable tubing length at shipment	ft (m)	33 (10)	
Refrigerant	Narrow tube	inch (mm)	1/4 (6.35)	
	Wide tube	inch (mm)	5/8 (15.88)	
Refrigerant Tube Kit		Optional		
Dimensions & Weight			Indoor Unit	
	Unit Dimensions	inch	11-23/32 × 41-15/16 × 8-5/8	
	Height × Width × Depth	(mm)	(298 × 1,065 × 219)	
	Package Dimensions	inch	11-27/32 × 45-1/8 × 15-5/32	
	Height × Width × Depth	(mm)	(301 × 1,146 × 385)	
Weight	Net	lbs (kg)	26.5 (12.0)	
	Shipping	lbs (kg)	33.1 (15.0)	
Shipping Volume		cu.ft (m ³)	4.59 (0.13)	
			Outdoor Unit	
			29-1/8 × 35-7/16 × 12-19/32	
			(740 × 900 × 320)	
			34-3/16 × 41-11/32 × 16-21/32	
			(868 × 1,050 × 423)	

DATA SUBJECT TO CHANGE WITHOUT NOTICE.

Remarks: Rating conditions are:

Cooling: Indoor air temperature 80 °F DB / 67 °F WB

Outdoor air temperature 95 °F DB / 75 °F WB

Indoor Unit **CS-KS24NKU**
 Outdoor Unit **CU-KS24NKU**

< 208V >

Voltage Rating		208V Single-Phase 60Hz		
Performance			Cooling	
	Total Capacity	BTU/h kW	24,200 (4,000 to 24,200) 7.1 (1.2 to 7.1)	
	Sensible Capacity	BTU/h	14,800	
	Latent Capacity	BTU/h	9,400	
	Air Circulation (Hi/Me/Lo)	ft ³ /min (m ³ /h)	659 (1,120) / 571 (970) / 494 (839)	
	Moisture Removal (High)	Pints/h	4.89	
Electrical Rating	Available Voltage Range	V	187 to 253	
	Running Amperes	A	12.1 (1.3 to 12.1)	
	Power Input	W	2,460 (280 to 2,460)	
	Power Factor	%	98	
	EER	BTU/h/W	9.8	
	SEER	BTU/Wh	17	
	Compressor Locked Rotor Amperes	A	17.5	
	Fuse or Circuit Breaker Capacity	A	20	
Features	Controls / Temperature Control		Microprocessor / I.C. Thermistor	
	Control Unit		Wireless Remote Control Unit	
	Timer		24-Hour ON or OFF Timer, 1-Hour OFF Timer	
	Fan Speeds	Indoor / Outdoor	Auto and 3 steps / Auto (Hi, Me, Lo)	
	Airflow Direction (Indoor)	Horizontal	Manual	
		Vertical	Auto	
	Air Filter		Washable, Anti-Mold	
	Compressor		DC Twin Rotary (Inverter)	
	Refrigerant / Amount charged at shipment	lbs (g)	R410A / 4.30 (1,950)	
	Refrigerant Control		Electric Expansion Valve	
	Operation Sound	Indoor : Hi/Me/Lo/Qt*	dB-A	47 / 44 / 41 / 30
		Outdoor : Hi		
	Refrigerant Tubing Connections		Flare Type	
	Max. allowable tubing length at shipment	ft (m)	33 (10)	
	Refrigerant	Narrow tube	inch (mm)	1/4 (6.35)
Wide tube		inch (mm)	5/8 (15.88)	
Refrigerant Tube Kit		Optional		
Dimensions & Weight			Indoor Unit	
	Unit Dimensions	inch	11-23/32 × 41-15/16 × 8-5/8	
	Height × Width × Depth	(mm)	(298 × 1,065 × 219)	
	Package Dimensions	inch	11-27/32 × 45-1/8 × 15-5/32	
	Height × Width × Depth	(mm)	(301 × 1,146 × 385)	
Weight	Net	lbs (kg)	26.5 (12.0)	
	Shipping	lbs (kg)	33.1 (15.0)	
Shipping Volume		cu.ft (m ³)	4.59 (0.13)	
			Outdoor Unit	
			29-1/8 × 35-7/16 × 12-19/32	
			(740 × 900 × 320)	
			34-3/16 × 41-11/32 × 16-21/32	
			(868 × 1,050 × 423)	

DATA SUBJECT TO CHANGE WITHOUT NOTICE.

Remarks: Rating conditions are:

Cooling: Indoor air temperature 80 °F DB / 67 °F WB

Outdoor air temperature 95 °F DB / 75 °F WB

Indoor Unit **CS-KS18NKU**
 Outdoor Unit **CU-KS18NKUA**

< 230V >

Voltage Rating		230V Single-Phase 60Hz		
Performance			Cooling	
	Total Capacity	BTU/h kW	17,500 (4,000 to 17,500) 5.15 (1.2 to 5.15)	
	Sensible Capacity	BTU/h	13,100	
	Latent Capacity	BTU/h	4,400	
	Air Circulation (Hi/Me/Lo)	ft ³ /min (m ³ /h)	524 (890) / 441 (749) / 377 (641)	
	Moisture Removal (High)	Pints/h	4.89	
Electrical Rating	Available Voltage Range	V	187 to 253	
	Running Amperes	A	7.0 (1.2 to 7.0)	
	Power Input	W	1,500 (250 to 1,500)	
	Power Factor	%	93	
	EER	BTU/h/W	11.7	
	SEER	BTU/Wh	20	
	Compressor Locked Rotor Amperes	A	17.5	
	Fuse or Circuit Breaker Capacity	A	15	
Features	Controls / Temperature Control		Microprocessor / I.C. Thermistor	
	Control Unit		Wireless Remote Control Unit	
	Timer		24-Hour ON or OFF Timer, 1-Hour OFF Timer	
	Fan Speeds	Indoor / Outdoor	Auto and 3 steps / Auto (Hi and multi steps)	
	Airflow Direction (Indoor)	Horizontal	Manual	
		Vertical	Auto	
	Air Filter		Washable, Anti-Mold	
	Compressor		DC Twin Rotary (Inverter)	
	Refrigerant / Amount charged at shipment	lbs (g)	R410A / 2.87 (1,300)	
	Refrigerant Control		Electric Expansion Valve	
	Operation Sound	Indoor : Hi/Me/Lo/Qt*	dB-A	42 / 38 / 30 / 28
		Outdoor : Hi		
	Refrigerant Tubing Connections		Flare Type	
	Max. allowable tubing length at shipment	ft (m)	25 (7.5)	
	Refrigerant	Narrow tube	inch (mm)	1/4 (6.35)
Wide tube		inch (mm)	1/2 (12.7)	
Refrigerant Tube Kit		Optional		
Dimensions & Weight			Indoor Unit	
	Unit Dimensions	inch	11-23/32 × 41-15/16 × 8-5/8	
	Height × Width × Depth	(mm)	(298 × 1,065 × 219)	
	Package Dimensions	inch	28-27/32 × 39-27/32 × 14-29/32	
	Height × Width × Depth	(mm)	(733 × 1,012 × 379)	
Weight	Net	lbs (kg)	26.5 (12.0)	
	Shipping	lbs (kg)	33.1 (15.0)	
Shipping Volume		cu.ft (m ³)	4.59 (0.13)	
			9.88 (0.28)	

DATA SUBJECT TO CHANGE WITHOUT NOTICE.

Remarks: Rating conditions are:
 Cooling: Indoor air temperature 80 °F DB / 67 °F WB
 Outdoor air temperature 95 °F DB / 75 °F WB

Indoor Unit **CS-KS18NKU**
 Outdoor Unit **CU-KS18NKUA**

< 208V >

Voltage Rating		208V Single-Phase 60Hz		
Performance			Cooling	
	Total Capacity	BTU/h kW	17,500 (4,000 to 17,500) 5.15 (1.2 to 5.15)	
	Sensible Capacity	BTU/h	13,100	
	Latent Capacity	BTU/h	4,400	
	Air Circulation (Hi/Me/Lo)	ft ³ /min (m ³ /h)	524 (890) / 441 (749) / 377 (641)	
	Moisture Removal (High)	Pints/h	4.89	
Electrical Rating	Available Voltage Range	V	187 to 253	
	Running Amperes	A	7.7 (1.2 to 7.7)	
	Power Input	W	1,500 (250 to 1,500)	
	Power Factor	%	94	
	EER	BTU/h/W	11.7	
	SEER	BTU/Wh	20	
	Compressor Locked Rotor Amperes	A	17.5	
	Fuse or Circuit Breaker Capacity	A	15	
Features	Controls / Temperature Control		Microprocessor / I.C. Thermistor	
	Control Unit		Wireless Remote Control Unit	
	Timer		24-Hour ON or OFF Timer, 1-Hour OFF Timer	
	Fan Speeds	Indoor / Outdoor	Auto and 3 steps / Auto (Hi and multi steps)	
	Airflow Direction (Indoor)	Horizontal	Manual	
		Vertical	Auto	
	Air Filter		Washable, Anti-Mold	
	Compressor		DC Twin Rotary (Inverter)	
	Refrigerant / Amount charged at shipment	lbs (g)	R410A / 2.87 (1,300)	
	Refrigerant Control		Electric Expansion Valve	
	Operation Sound	Indoor : Hi/Me/Lo/Qt*	dB-A	42 / 38 / 30 / 28
		Outdoor : Hi		
	Refrigerant Tubing Connections		Flare Type	
	Max. allowable tubing length at shipment	ft (m)	25 (7.5)	
	Refrigerant	Narrow tube	inch (mm)	1/4 (6.35)
Wide tube		inch (mm)	1/2 (12.7)	
Refrigerant Tube Kit		Optional		
Dimensions & Weight			Indoor Unit	
	Unit Dimensions	inch	11-23/32 × 41-15/16 × 8-5/8	
	Height × Width × Depth	(mm)	(298 × 1,065 × 219)	
	Package Dimensions	inch	28-27/32 × 39-27/32 × 14-29/32	
	Height × Width × Depth	(mm)	(733 × 1,012 × 379)	
	Weight	Net	lbs (kg)	26.5 (12.0)
Shipping		lbs (kg)	33.1 (15.0)	
Shipping Volume		cu.ft (m ³)	4.59 (0.13)	
			Outdoor Unit	
			26-3/8 × 34-21/32 × 11-7/32	
			(670 × 880 × 285)	
			90.4 (41.0)	
			99.2 (45.0)	
			9.88 (0.28)	

DATA SUBJECT TO CHANGE WITHOUT NOTICE.

Remarks: Rating conditions are:

Cooling: Indoor air temperature 80 °F DB / 67 °F WB

Outdoor air temperature 95 °F DB / 75 °F WB

Indoor Unit **CS-KS24NKU**
 Outdoor Unit **CU-KS24NKUA**

< 230V >

Voltage Rating		230V Single-Phase 60Hz		
Performance			Cooling	
	Total Capacity	BTU/h kW	24,200 (4,000 to 24,200) 7.1 (1.2 to 7.1)	
	Sensible Capacity	BTU/h	14,800	
	Latent Capacity	BTU/h	9,400	
	Air Circulation (Hi/Me/Lo)	ft ³ /min (m ³ /h)	659 (1,120) / 571 (970) / 494 (839)	
	Moisture Removal (High)	Pints/h	4.89	
Electrical Rating	Available Voltage Range	V	187 to 253	
	Running Amperes	A	10.8 (1.3 to 10.8)	
	Power Input	W	2,460 (280 to 2,460)	
	Power Factor	%	99	
	EER	BTU/h/W	9.8	
	SEER	BTU/Wh	17	
	Compressor Locked Rotor Amperes	A	17.5	
	Fuse or Circuit Breaker Capacity	A	20	
Features	Controls / Temperature Control		Microprocessor / I.C. Thermistor	
	Control Unit		Wireless Remote Control Unit	
	Timer		24-Hour ON or OFF Timer, 1-Hour OFF Timer	
	Fan Speeds	Indoor / Outdoor	Auto and 3 steps / Auto (Hi and multi steps)	
	Airflow Direction (Indoor)	Horizontal	Manual	
		Vertical	Auto	
	Air Filter		Washable, Anti-Mold	
	Compressor		DC Twin Rotary (Inverter)	
	Refrigerant / Amount charged at shipment	lbs (g)	R410A / 4.30 (1,950)	
	Refrigerant Control		Electric Expansion Valve	
	Operation Sound	Indoor : Hi/Me/Lo/Qt*	dB-A	47 / 44 / 41 / 30
		Outdoor : Hi		
	Refrigerant Tubing Connections		Flare Type	
	Max. allowable tubing length at shipment	ft (m)	33 (10)	
	Refrigerant	Narrow tube	inch (mm)	1/4 (6.35)
Wide tube		inch (mm)	5/8 (15.88)	
Refrigerant Tube Kit		Optional		
Dimensions & Weight			Indoor Unit	
	Unit Dimensions	inch	29-1/8 × 35-7/16 × 12-19/32	
	Height × Width × Depth	(mm)	(740 × 900 × 320)	
	Package Dimensions	inch	34-3/16 × 41-11/32 × 16-21/32	
	Height × Width × Depth	(mm)	(868 × 1,050 × 423)	
	Weight	Net	lbs (kg)	119.0 (54.0)
Shipping		lbs (kg)	127.9 (58.0)	
Shipping Volume		cu.ft (m ³)	13.41 (0.38)	

DATA SUBJECT TO CHANGE WITHOUT NOTICE.

Remarks: Rating conditions are:

Cooling: Indoor air temperature 80 °F DB / 67 °F WB
 Outdoor air temperature 95 °F DB / 75 °F WB

Indoor Unit **CS-KS24NKU**
 Outdoor Unit **CU-KS24NKUA**

< 208V >

Voltage Rating		208V Single-Phase 60Hz		
Performance			Cooling	
	Total Capacity	BTU/h kW	24,200 (4,000 to 24,200) 7.1 (1.2 to 7.1)	
	Sensible Capacity	BTU/h	14,800	
	Latent Capacity	BTU/h	9,400	
	Air Circulation (Hi/Me/Lo)	ft ³ /min (m ³ /h)	659 (1,120) / 571 (970) / 494 (839)	
	Moisture Removal (High)	Pints/h	4.89	
Electrical Rating	Available Voltage Range	V	187 to 253	
	Running Amperes	A	12.1 (1.3 to 12.1)	
	Power Input	W	2,460 (280 to 2,460)	
	Power Factor	%	98	
	EER	BTU/h/W	9.8	
	SEER	BTU/Wh	17	
	Compressor Locked Rotor Amperes	A	17.5	
	Fuse or Circuit Breaker Capacity	A	20	
Features	Controls / Temperature Control		Microprocessor / I.C. Thermistor	
	Control Unit		Wireless Remote Control Unit	
	Timer		24-Hour ON or OFF Timer, 1-Hour OFF Timer	
	Fan Speeds	Indoor / Outdoor	Auto and 3 steps / Auto (Hi and multi steps)	
	Airflow Direction (Indoor)	Horizontal	Manual	
		Vertical	Auto	
	Air Filter		Washable, Anti-Mold	
	Compressor		DC Twin Rotary (Inverter)	
	Refrigerant / Amount charged at shipment	lbs (g)	R410A / 4.30 (1,950)	
	Refrigerant Control		Electric Expansion Valve	
	Operation Sound	Indoor : Hi/Me/Lo/Qt*	dB-A	47 / 44 / 41 / 30
		Outdoor : Hi		
	Refrigerant Tubing Connections		Flare Type	
	Max. allowable tubing length at shipment	ft (m)	33 (10)	
	Refrigerant	Narrow tube	inch (mm)	1/4 (6.35)
Wide tube		inch (mm)	5/8 (15.88)	
Refrigerant Tube Kit		Optional		
Dimensions & Weight			Indoor Unit	
	Unit Dimensions	inch	29-1/8 × 35-7/16 × 12-19/32	
	Height × Width × Depth	(mm)	(740 × 900 × 320)	
	Package Dimensions	inch	34-3/16 × 41-11/32 × 16-21/32	
	Height × Width × Depth	(mm)	(868 × 1,050 × 423)	
Weight	Net	lbs (kg)	26.5 (12.0)	
	Shipping	lbs (kg)	33.1 (15.0)	
Shipping Volume		cu.ft (m ³)	4.59 (0.13)	
			13.41 (0.38)	

DATA SUBJECT TO CHANGE WITHOUT NOTICE.

Remarks: Rating conditions are:

Cooling: Indoor air temperature 80 °F DB / 67 °F WB
 Outdoor air temperature 95 °F DB / 75 °F WB

2-2. Major Component Specifications

2-2-1. Indoor Unit

Indoor Unit **CS-KS18NKU**

Control PCB		
Part No.		CB-CS-KS18NKU
Controls		Microprocessor
Control Circuit Fuse		250V 3A

Fan		
Type		Cross-Flow
Q'ty ... Dia. and Length	inch (mm)	1 ... D3-5/8 / L33-9/32 (D92/L845)

Fan Motor		
Type		DC Motor
Model ... Q'ty		SIC-41CVJ-D847-3 ... 1
No. of Poles		8
Rough Measure RPM (Cool)		1,250
Nominal Output	W	30
Coil Resistance	Ohm	-
(Ambient Temp. 68 °F (20 °C))		
Safety Device		
Type		Internal Controller
Over-Current Protection		Yes
Over-Heat Protection		Yes
Run Capacitor	Micro F	-
	VAC	-

Flap Motor		
Type		Stepping Motor
Model		MP24Z3
Rating		DC 12V
Coil Resistance	Ohm	Each Pair of Terminal : 400 +/- 7%
(Ambient Temp. 77 °F (25 °C))		

Heat Exchanger Coil		
Coil		Aluminum Plate Fin / Copper Tube
Rows		2
Fins per inch		19.5
Face Area	ft ² (m ²)	3.07 (0.285)

DATA SUBJECT TO CHANGE WITHOUT NOTICE.

Indoor Unit **CS-KS24NKU**

Control PCB		
Part No.		CB-CS-KS24NKU
Controls		Microprocessor
Control Circuit Fuse		250V 3A

Fan		
Type		Cross-Flow
Q'ty ... Dia. and Length	inch (mm)	1 ... D3-5/8 / L33-9/32 (D92/L845)

Fan Motor		
Type		DC Motor
Model ... Q'ty		SIC-41CVJ-D847-3 ... 1
No. of Poles		8
Rough Measure RPM (Cool)		1,500
Nominal Output	W	30
Coil Resistance	Ohm	-
(Ambient Temp. 68 °F (20 °C))		
Safety Device		
Type		Internal Controller
Over-Current Protection		Yes
Over-Heat Protection		Yes
Run Capacitor	Micro F	-
	VAC	-

Flap Motor		
Type		Stepping Motor
Model		MP24Z3
Rating		DC 12V
Coil Resistance	Ohm	Each Pair of Terminal : 400 +/- 7%
(Ambient Temp. 77 °F (25 °C))		

Heat Exchanger Coil		
Coil		Aluminum Plate Fin / Copper Tube
Rows		2
Fins per inch		19.5
Face Area	ft ² (m ²)	3.07 (0.285)

DATA SUBJECT TO CHANGE WITHOUT NOTICE.

2-2-2. Outdoor Unit

Outdoor Unit **CU-KS18NKU**

Control PCB	
Part No.	CB-CU-KS18NKU
Controls	Microprocessor
Control Circuit Fuse	250V 25A

Compressor	
Type	DC Twin Rotary (Hermetic)
Compressor Model / Nominal Output	C-6RVN93H0M / 1,050W
Compressor Oil ... Amount	Pints (cc) FV50S ... 0.74 (350)
Coil Resistance (Ambient Temp. 68 °F (20 °C))	Ohm U - V : 0.482 V - W : 0.482 W - U : 0.482
Safety Device	
CT (Peak current cut-off control)	Yes
Compressor Discharge Temp. Control	Yes
Operation cut-off control in abnormal ambient Temp.	Yes
Overload Relay	Model CS-7L115
	Operation Temp. Open : 239 °F (115 °C), Close : 203 °F (95 °C)
Run Capacitor	Micro F -
	VAC -
Crankcase Heater	-

Fan	
Type	Propeller
Q'ty ... Dia.	inch (mm) 1 ... D16-17/32 (D420)

Fan Motor	
Type	DC Motor
Model ... Q'ty	SIC-67FV-F460-1 ... 1
No. of Poles	8
Rough Measure RPM (Cool)	820
Nominal Output	W 50
Coil Resistance	Ohm RED - WHT : 77.5 WHT - BLU : 77.5 BLU - RED : 77.5
Safety Device	
Type	Internal Controller
Over- Current Protection	Yes
Run Capacitor	Micro F -
	VAC -

Heat Exchanger Coil	
Coil	Aluminum Plate Fin / Copper Tube
Rows	2
Fins per inch	21.2
Face Area	ft ² (m ²) 5.49 (0.510)

External Finish	Acrylic baked-on enamel finish
------------------------	--------------------------------

DATA SUBJECT TO CHANGE WITHOUT NOTICE.

Outdoor Unit **CU-KS24NKU**

Control PCB	
Part No.	CB-CU-KS24NKU
Controls	Microprocessor
Control Circuit Fuse	250V 25A

Compressor	
Type	DC Twin Rotary (Hermetic)
Compressor Model / Nominal Output	G8T265FU1JW / 2,410W
Compressor Oil ... Amount	Pints (cc) FV50S ... 1.49 (700)
Coil Resistance (Ambient Temp. 77 °F (25 °C))	Ohm U - V : 0.36 V - W : 0.36 W - U : 0.36
Safety Device	
CT (Peak current cut-off control)	Yes
Compressor Discharge Temp. Control	Yes
Operation cut-off control in abnormal ambient Temp.	Yes
Overload Relay	Model CS-7L115
	Operation Temp. Open : 239 °F (115 °C), Close : 203 °F (95 °C)
Run Capacitor	Micro F -
	VAC -
Crankcase Heater	-

Fan	
Type	Propeller
Q'ty ... Dia.	inch (mm) 1 ... D18-1/8 (D460)

Fan Motor	
Type	DC Motor
Model ... Q'ty	SIC-71FW-D490-1 ... 1
No. of Poles	8
Rough Measure RPM (Cool)	850
Nominal Output	W 90
Coil Resistance	Ohm -
(Ambient Temp. 68 °F (20 °C))	
Safety Device	
Type	Internal Controller
Over-Current Protection	Yes
Over-Heat Protection	Yes
Run Capacitor	Micro F -
	VAC -

Heat Exchanger Coil	
Coil	Aluminum Plate Fin / Copper Tube
Rows	2
Fins per inch	18.1
Face Area	ft ² (m ²) 6.40 (0.595)

External Finish	
	Acrylic baked-on enamel finish

DATA SUBJECT TO CHANGE WITHOUT NOTICE.

Outdoor Unit **CU-KS18NKUA**

Control PCB	
Part No.	CB-CU-KS18NKUA
Controls	Microprocessor
Control Circuit Fuse	250V 25A

Compressor	
Type	DC Twin Rotary (Hermetic)
Compressor Model / Nominal Output	C-6RVN93H0M / 1,050W
Compressor Oil ... Amount	Pints (cc) FV50S ... 0.74 (350)
Coil Resistance (Ambient Temp. 68 °F (20 °C))	Ohm R - S : 0.482 S - T : 0.482 T - R : 0.482
Safety Device	
CT (Peak current cut-off control)	Yes
Compressor Discharge Temp. Control	Yes
Operation cut-off control in abnormal ambient Temp.	Yes
Overload Relay	Model CS-7L115
	Operation Temp. Open : 239 °F (115 °C), Close : 203 °F (95 °C)
Run Capacitor	Micro F -
	VAC -
Crankcase Heater	-

Fan	
Type	Propeller
Q'ty ... Dia.	inch (mm) 1 ... D16-17/32 (D420)

Fan Motor	
Type	DC Motor
Model ... Q'ty	SIC-67FV-F460-1 ... 1
No. of Poles	8
Rough Measure RPM (Cool)	820
Nominal Output	W 50
Coil Resistance	Ohm RED - WHT : 77.5 WHT - BLU : 77.5 BLU - RED : 77.5
Safety Device	
Type	Internal Controller
Over- Current Protection	Yes
Run Capacitor	Micro F -
	VAC -

Heat Exchanger Coil	
Coil	Aluminum Plate Fin / Copper Tube
Rows	2
Fins per inch	21.2
Face Area	ft ² (m ²) 5.49 (0.510)

External Finish	Acrylic baked-on enamel finish
------------------------	--------------------------------

DATA SUBJECT TO CHANGE WITHOUT NOTICE.

Outdoor Unit **CU-KS24NKUA**

Control PCB	
Part No.	CB-CU-KS24NKUA
Controls	Microprocessor
Control Circuit Fuse	250V 25A

Compressor	
Type	DC Twin Rotary (Hermetic)
Compressor Model / Nominal Output	G8T265FU1JW / 2,410W
Compressor Oil ... Amount	Pints (cc) FV50S ... 1.49 (700)
Coil Resistance (Ambient Temp. 77 °F (25 °C))	Ohm U - V : 0.36 V - W : 0.36 W - U : 0.36
Safety Device	
CT (Peak current cut-off control)	Yes
Compressor Discharge Temp. Control	Yes
Operation cut-off control in abnormal ambient Temp.	Yes
Overload Relay	Model CS-7L115
	Operation Temp. Open : 239 °F (115 °C), Close : 203 °F (95 °C)
Run Capacitor	Micro F -
	VAC -
Crankcase Heater	230V 30W

Fan	
Type	Propeller
Q'ty ... Dia.	inch (mm) 1 ... D18-1/8 (D460)

Fan Motor	
Type	DC Motor
Model ... Q'ty	SIC-71FW-D490-1 ... 1
No. of Poles	8
Rough Measure RPM (Cool)	850
Nominal Output	W 90
Coil Resistance	Ohm -
(Ambient Temp. 68 °F (20 °C))	
Safety Device	
Type	Internal Controller
Over-Current Protection	Yes
Over-Heat Protection	Yes
Run Capacitor	Micro F -
	VAC -

Heat Exchanger Coil	
Coil	Aluminum Plate Fin / Copper Tube
Rows	2
Fins per inch	18.1
Face Area	ft ² (m ²) 6.40 (0.595)

External Finish	Acrylic baked-on enamel finish
------------------------	--------------------------------

DATA SUBJECT TO CHANGE WITHOUT NOTICE.

2-3. Other Component Specifications

Indoor Unit **CS-KS18NKU**
CS-KS24NKU

Outdoor Unit **CU-KS18NKU CU-KS24NKU**
CU-KS18NKUA CU-KS24NKUA

- **Indoor air temp sensor**
 (Model:PTM-D51H-S4-2 TH2)

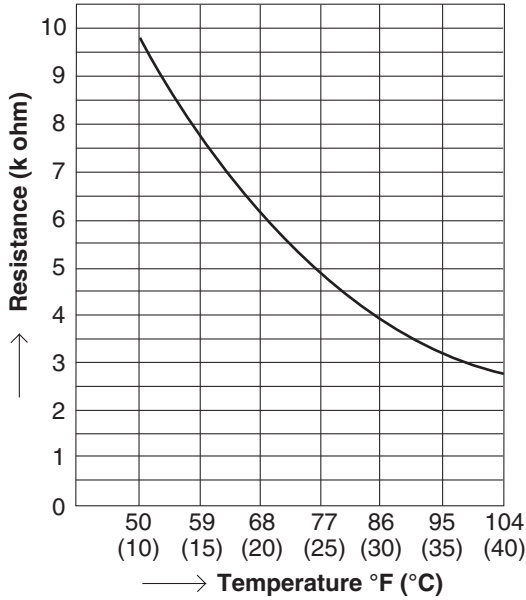

- **Indoor heat exchanger sensor**
 (Model:PTM-D51H-S4-2 TH1)
- **Compressor temp sensor**
 (Model:TKS 293B)

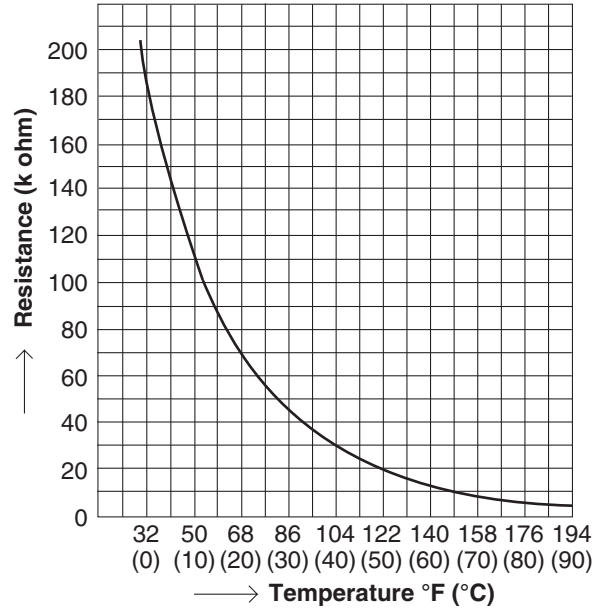

- **Outdoor air temp sensor**
 (Model:TKS295B)
- **Outdoor heat exchanger sensor**
 (Model:TKS292B)

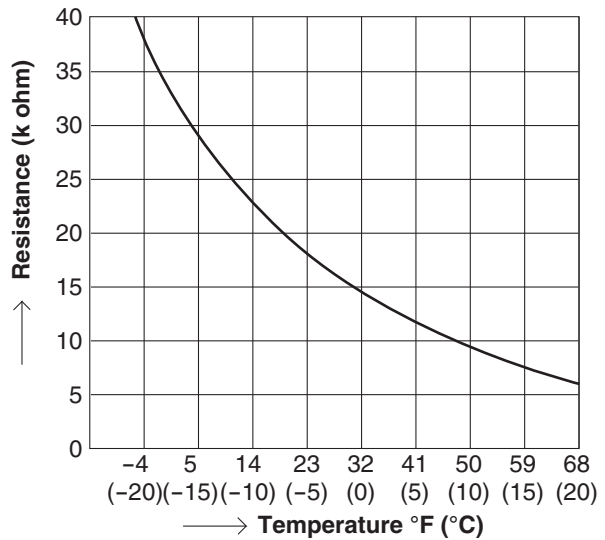

3. DIMENSIONAL DATA

Indoor Unit **CS-KS18NKU**
CS-KS24NKU

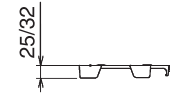
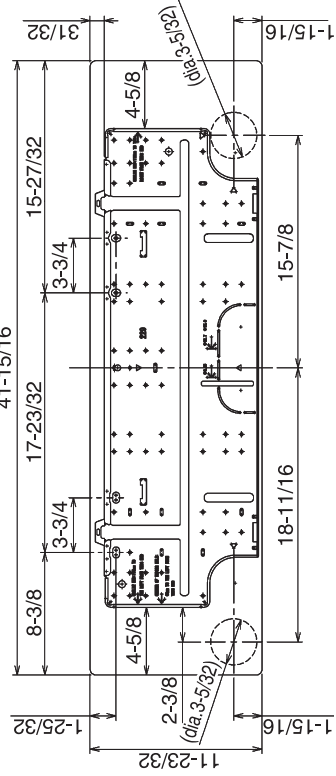
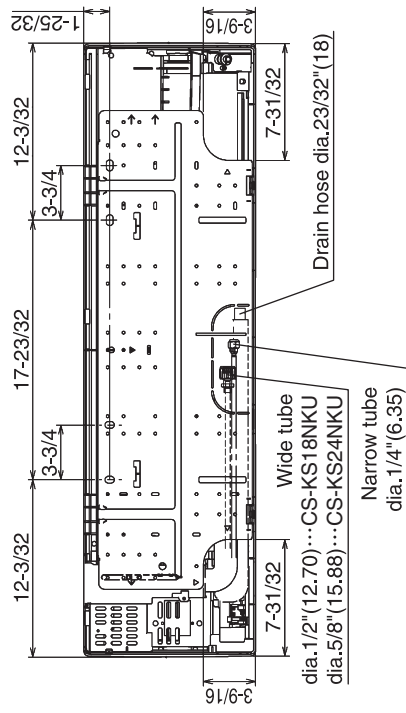
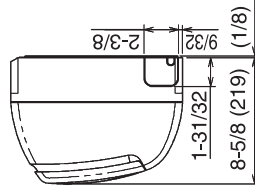
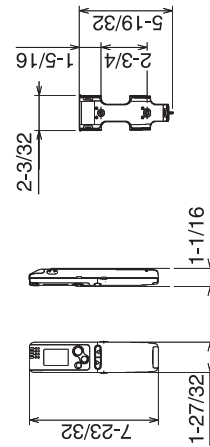
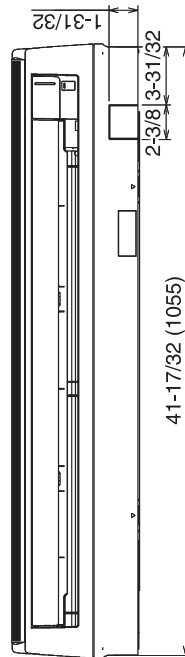
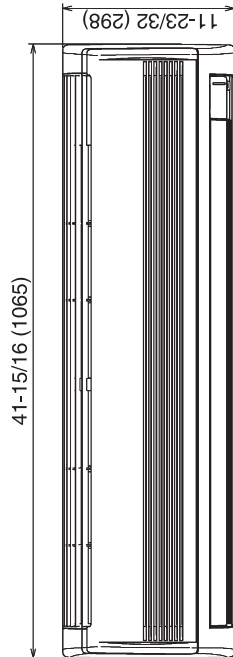
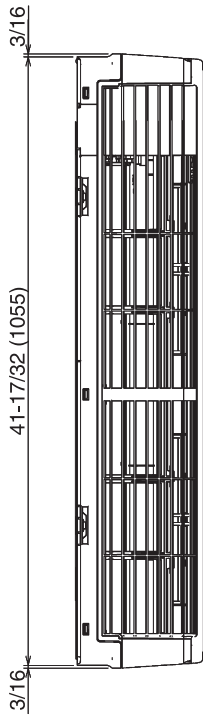

Unit: inch(mm)
(852-0-0010-216-00-0)

Outdoor Unit **CU-KS18NKU**
CU-KS18NKUA

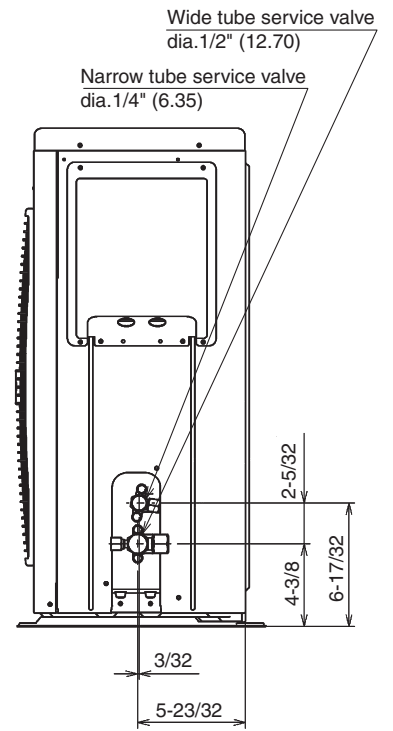
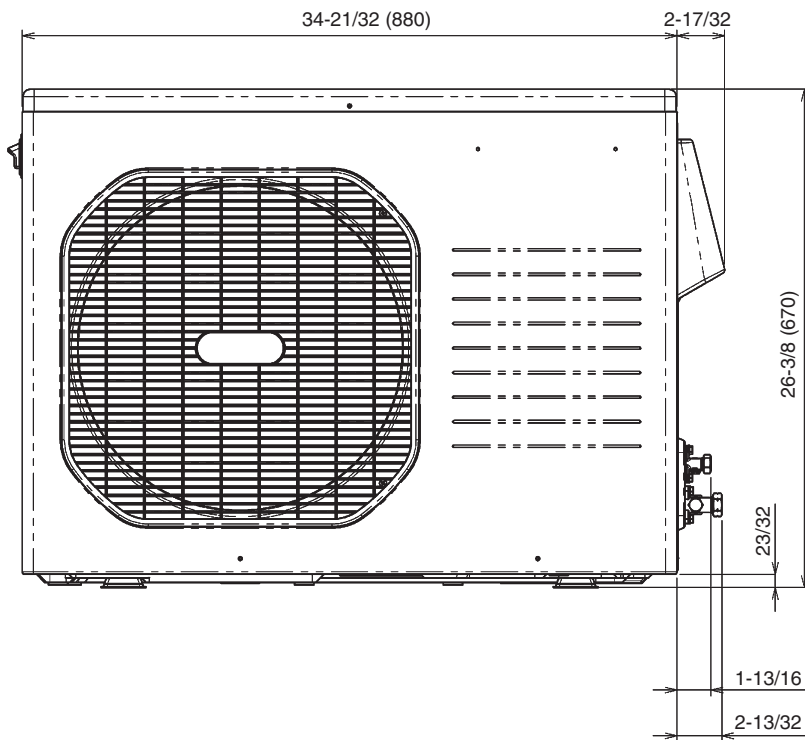
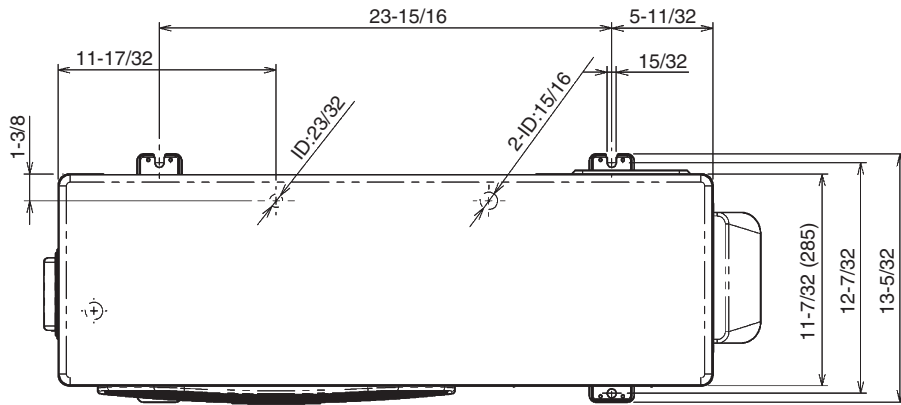

Unit: inch(mm)
(852-0-0010-133-00-0)

Outdoor Unit **CU-KS24NKU**
CU-KS24NKUA

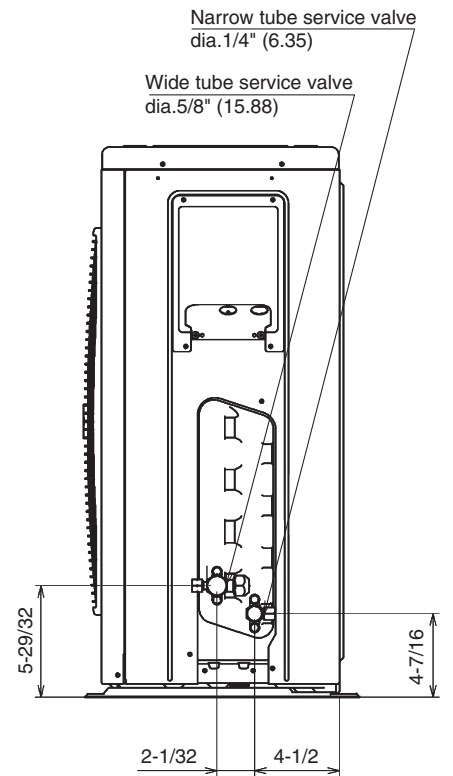
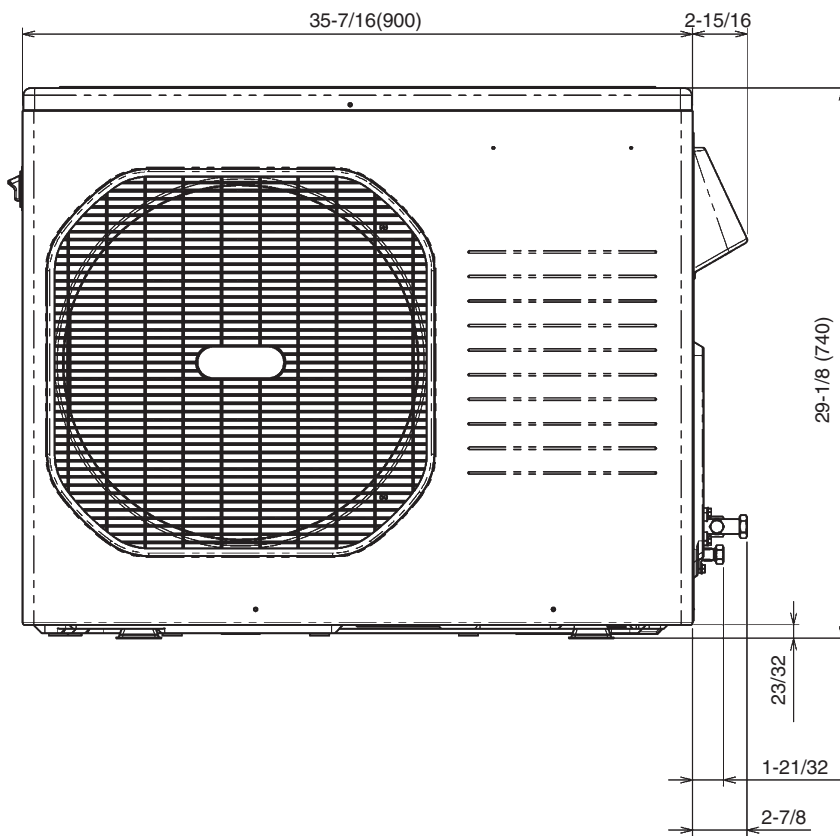
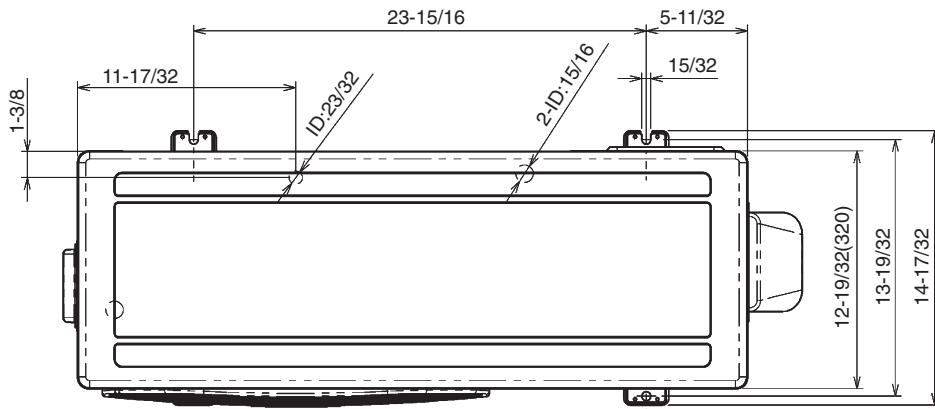

Unit: inch(mm)
 (852-0-0010-119-00-0)

4. REFRIGERANT FLOW DIAGRAM

4-1. Refrigerant Flow Diagram

Indoor Unit **CS-KS18NKU**
CS-KS24NKU

Outdoor Unit **CU-KS18NKU** **CU-KS24NKU**
CU-KS18NKUA **CU-KS24NKUA**

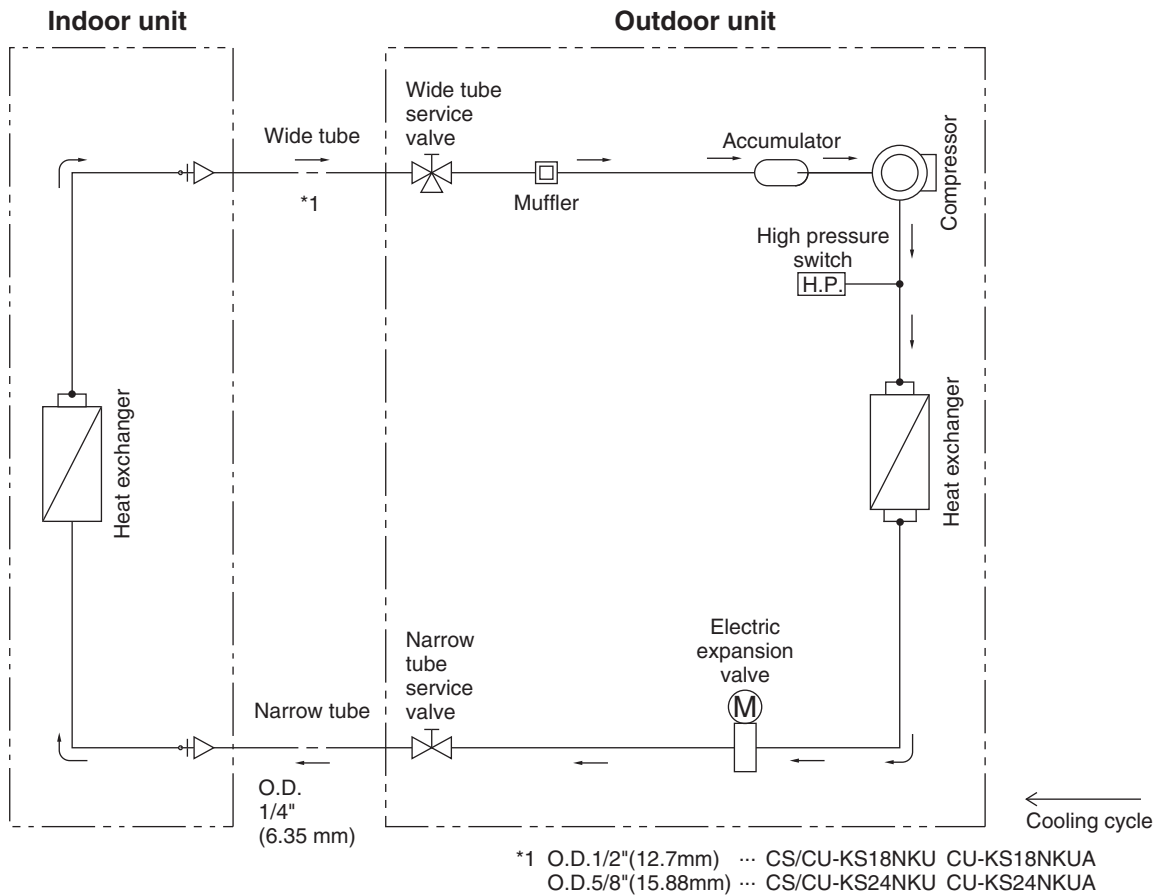

Insulation of Refrigerant Tubing

IMPORTANT

Because capillary tubing is used in the outdoor unit, both the wide and narrow tubes of this air conditioner become cold. To prevent heat loss and wet floors due to dripping of condensation, **both tubes must be well insulated** with a proper insulation material. The thickness of the insulation should be a min. 5/16" (8 mm).

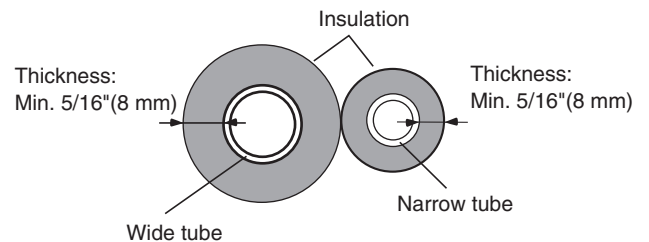

CAUTION

After a tube has been insulated, never try to bend it into a narrow curve because it can cause the tube to break or crack.

5. PERFORMANCE DATA

5-1. Temperature Charts

Indoor Unit **CS-KS18NKU**

Outdoor Unit **CU-KS18NKU**

■ Cooling Characteristics (RH : 46%, Indoor fan speed : High fan) (60Hz, 230V)

(1) Low pressure performance chart

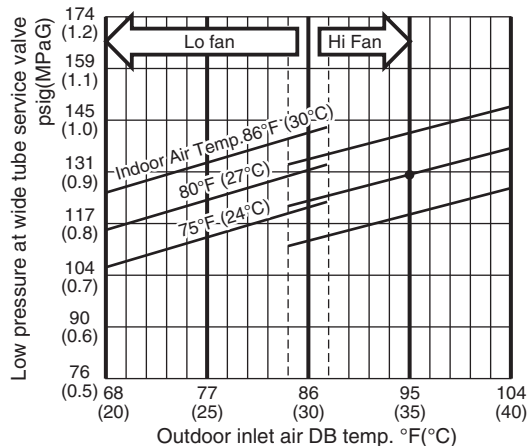

(2) Operating current performance chart

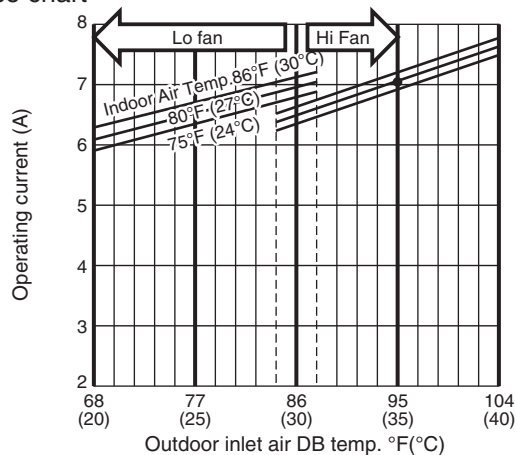

(3) Indoor discharge air performance chart

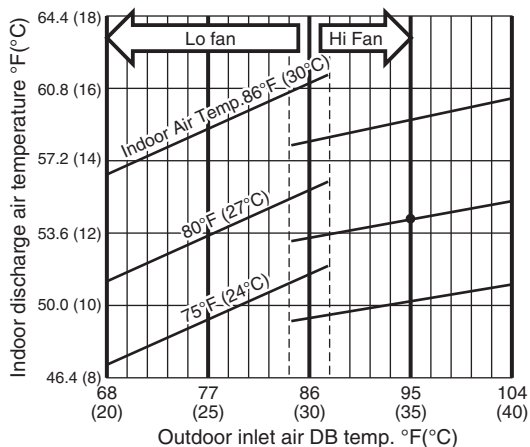

NOTE

- Check each performance value in test-run mode. Electrical performance values represent a combined indoor/outdoor value.

Indoor Unit **CS-KS18NKU**
 Outdoor Unit **CU-KS18NKUA**

■ Cooling Characteristics (RH : 46%, Indoor fan speed : High fan) (60Hz, 230V)

(1) Low pressure performance chart

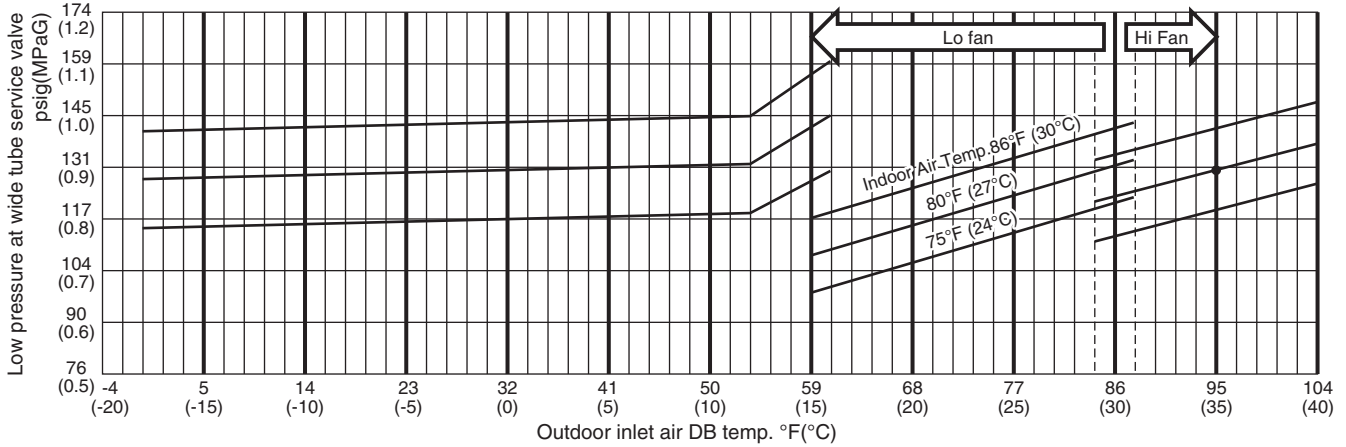

(2) Operating current performance chart

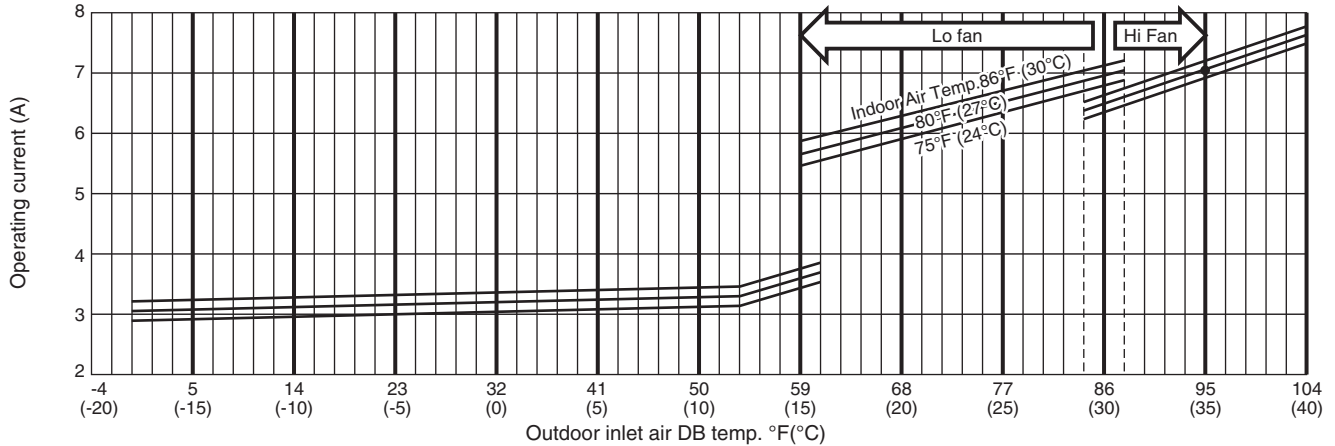

(3) Indoor discharge air performance chart

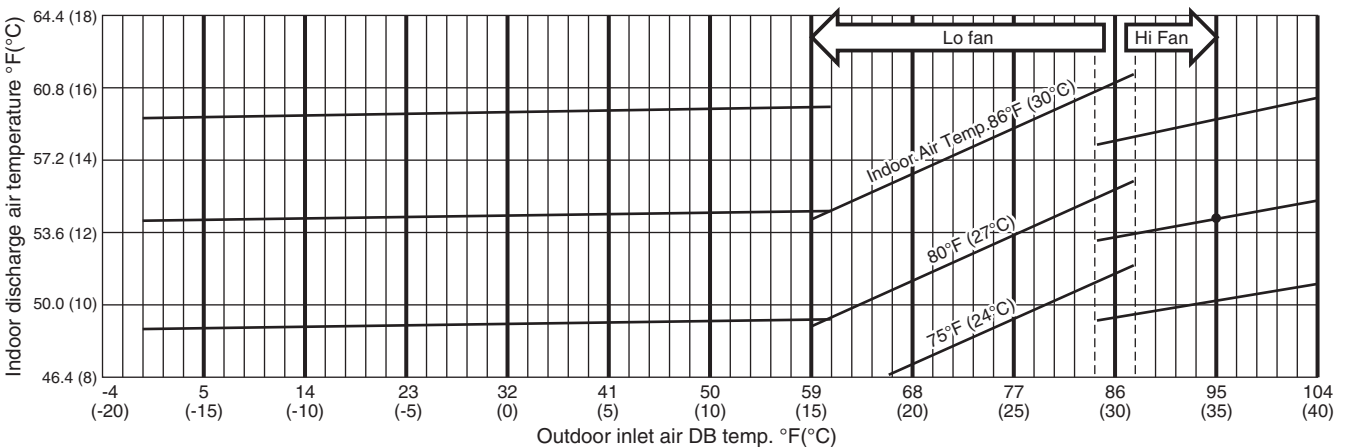

NOTE

- Check each performance value in test-run mode. Electrical performance values represent a combined indoor/outdoor value.

Indoor Unit **CS-KS24NKU**
 Outdoor Unit **CU-KS24NKU**

■ Cooling Characteristics (RH : 46%, Indoor fan speed : High fan) (60Hz, 230V)

(1) Low pressure performance chart

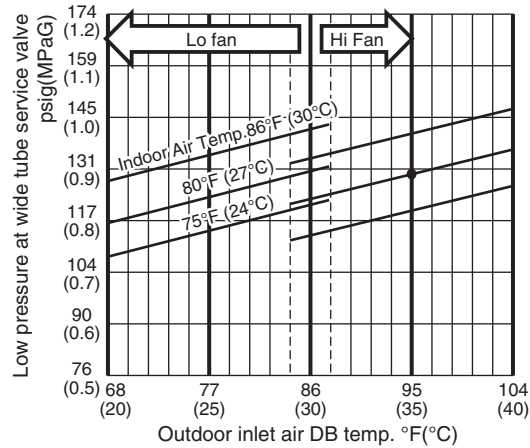

(2) Operating current performance chart

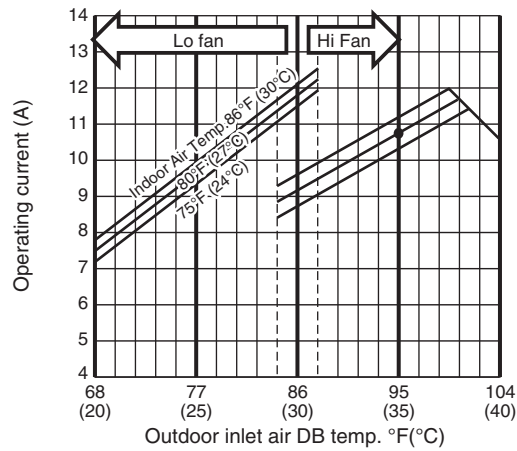

(3) Indoor discharge air performance chart

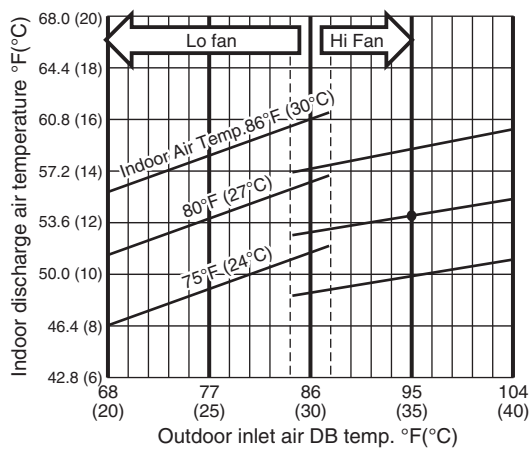

NOTE

• Check each performance value in test-run mode. Electrical performance values represent a combined indoor/outdoor value.

Indoor Unit **CS-KS24NKU**
 Outdoor Unit **CU-KS24NKUA**

■ Cooling Characteristics (RH : 46%, Indoor fan speed : High fan) (60Hz, 230V)

(1) Low pressure performance chart

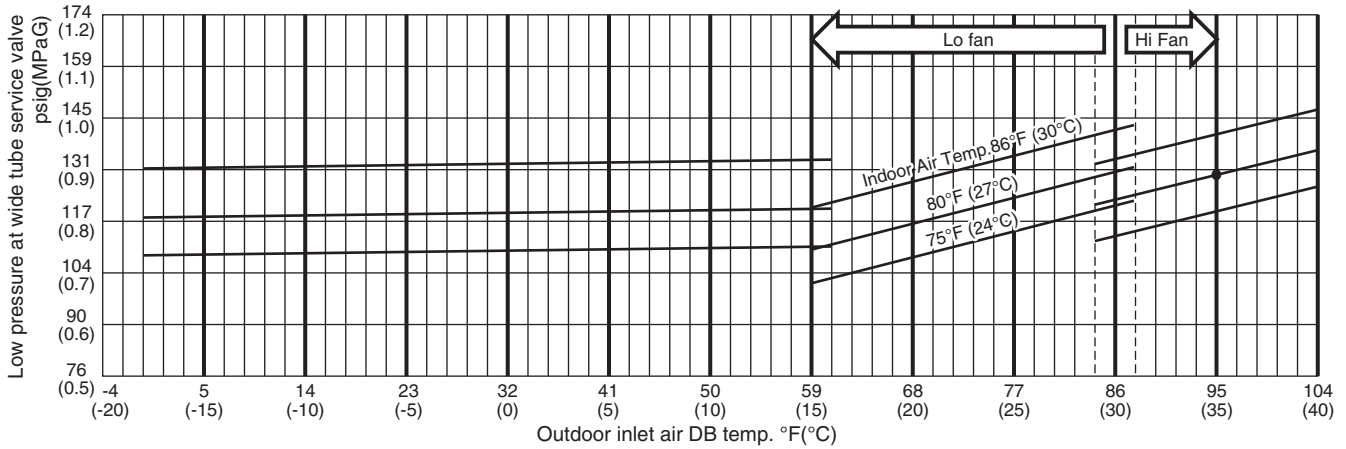

(2) Operating current performance chart

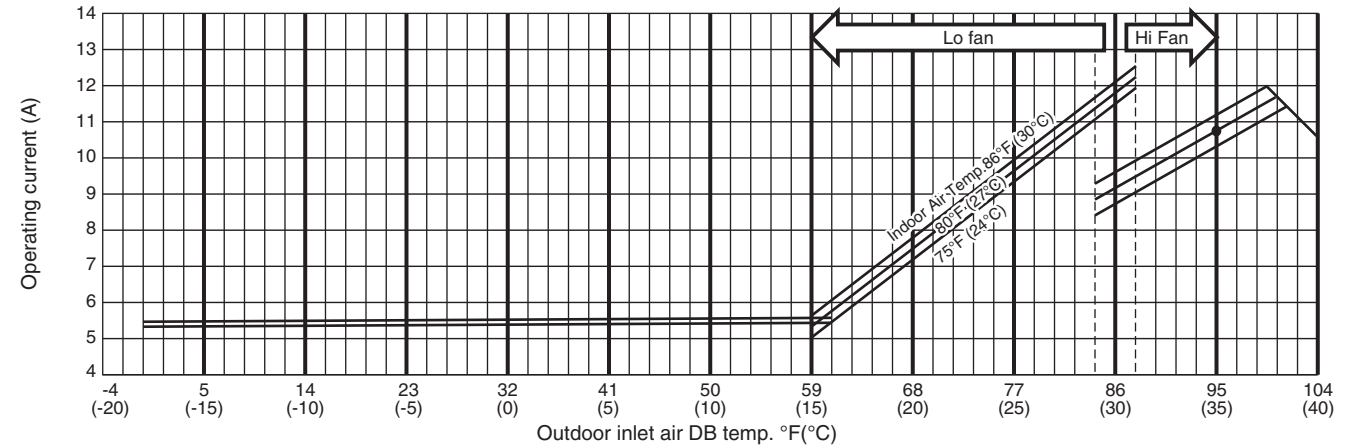

(3) Indoor discharge air performance chart

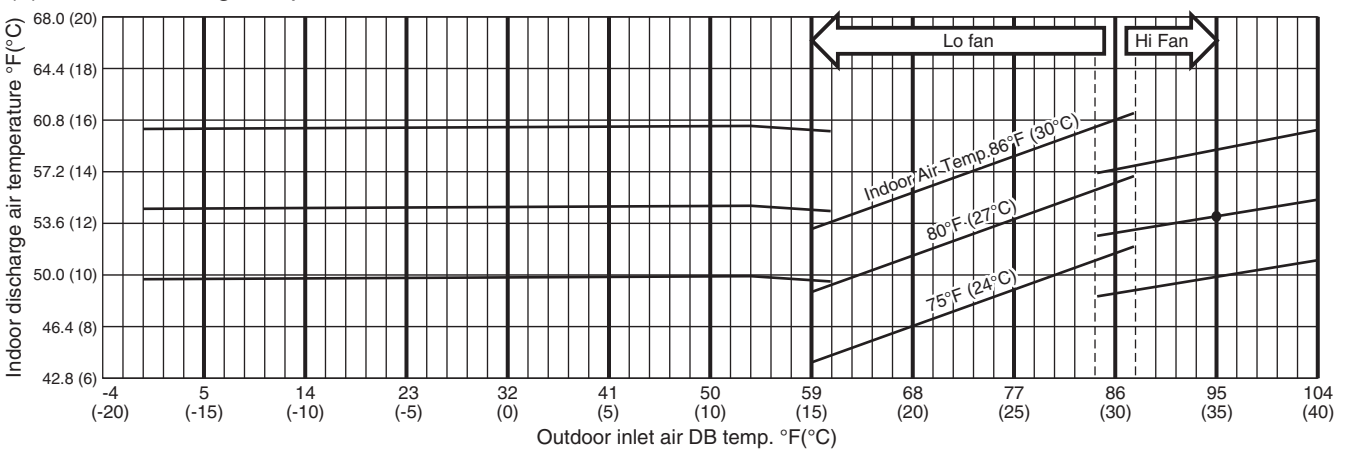

NOTE

• Check each performance value in test-run mode. Electrical performance values represent a combined indoor/outdoor value.

5-2. Cooling Capacity

Indoor Unit : **CS-KS18NKU**

Outdoor Unit : **CU-KS18NKU / CU-KS18NKUA**

Power Supply : 230V Single Phase 60Hz

< Cooling Capacity >

RATING CAPACITY:		17,500 BTU/h		AIR FLOW RATE:		524 CFM		
INDOOR		OUTDOOR						
ENT. TEMP. °F (°C)		AMBIENT TEMP. °F (°C)						
WB	DB		65 (18.3)	75 (23.9)	85 (29.4)	95 (35.0)	105 (40.6)	115 (46.1)
59 (15.0)		TC	16,270	16,440	16,590	16,040	15,320	10,700
	72 (22.2)	SHC	12,400	12,500	12,610	12,300	12,000	9,860
	76 (24.4)	SHC	14,130	14,230	14,340	14,030	13,720	10,700
	80 (26.7)	SHC	15,960	16,060	16,060	15,860	15,320	10,700
	84 (28.9)	SHC	16,270	16,440	16,590	16,040	15,320	10,700
	88 (31.1)	SHC	16,270	16,440	16,590	16,040	15,320	10,700
63 (17.2)		TC	18,460	17,920	17,330	16,770	16,040	10,940
	72 (22.2)	SHC	11,080	10,880	10,570	10,370	9,960	7,830
	76 (24.4)	SHC	12,810	12,610	12,300	12,000	11,690	9,550
	80 (26.7)	SHC	14,640	14,340	14,130	13,830	13,520	10,940
	84 (28.9)	SHC	16,370	16,060	15,860	15,560	15,250	10,940
	88 (31.1)	SHC	18,100	17,790	17,330	16,770	16,040	10,940
67 (19.4)		TC	19,190	18,650	18,060	# 17,500	16,560	11,150
	72 (22.2)	SHC	9,050	8,740	8,540	8,330	7,930	5,790
	76 (24.4)	SHC	10,780	10,470	10,270	10,060	9,660	7,520
	80 (26.7)	SHC	12,500	12,300	12,100	11,790	11,490	9,350
	84 (28.9)	SHC	14,230	14,030	13,830	13,520	13,110	11,080
	88 (31.1)	SHC	15,960	15,760	15,450	15,250	14,840	11,150
71 (21.7)		TC	19,880	19,350	18,760	18,220	16,840	11,330
	72 (22.2)	SHC	6,810	6,600	6,400	6,200	5,690	3,760
	76 (24.4)	SHC	8,540	8,330	8,130	7,930	7,420	5,490
	80 (26.7)	SHC	10,270	10,060	9,860	9,660	9,150	7,210
	84 (28.9)	SHC	12,000	11,790	11,590	11,390	10,880	8,940
	88 (31.1)	SHC	13,720	13,520	13,320	13,110	12,610	10,670
75 (23.9)		TC	20,470	19,940	19,350	18,830	17,030	11,450
	76 (24.4)	SHC	6,300	6,200	5,990	5,790	5,180	3,450
	80 (26.7)	SHC	8,130	7,930	7,720	7,620	7,010	5,280
	84 (28.9)	SHC	9,860	9,660	9,450	9,350	8,740	6,910
	88 (31.1)	SHC	11,590	11,390	11,180	10,980	10,470	8,640

TC : Total Cooling Capacity (BTU/h) SHC : Sensible Heat Capacity (BTU/h)

NOTE

- Rating conditions (#) : Indoor Unit Entering Air Temp. 80 °F (26.7 °C) DB / 67 °F (19.4 °C) WB
: Outdoor Ambient Temp. 95 °F (35 °C) DB
- Above data does not take Freeze Prevention Protection during cooling operation into account.
For this reason, the value may vary from the actual cooling characteristics.
- Above data represents the value when the operation frequency of a compressor is fixed.

Indoor Unit : **CS-KS24NKU**
 Outdoor Unit : **CU-KS24NKU / CU-KS24NKUA**
 Power Supply : 230V Single Phase 60Hz

< Cooling Capacity >

RATING CAPACITY:		24,200 BTU/h		AIR FLOW RATE:		659 CFM		
INDOOR		OUTDOOR						
ENT. TEMP. °F (°C)		AMBIENT TEMP. °F (°C)						
WB	DB		65 (18.3)	75 (23.9)	85 (29.4)	95 (35.0)	105 (40.6)	115 (46.1)
59 (15.0)		TC	21,050	21,240	21,410	21,470	18,230	11,020
	72 (22.2)	SHC	15,690	15,810	15,810	15,940	14,280	10,950
	76 (24.4)	SHC	17,730	17,860	17,990	17,990	16,330	11,020
	80 (26.7)	SHC	19,910	20,040	20,040	20,170	18,230	11,020
	84 (28.9)	SHC	21,050	21,240	21,410	21,470	18,230	11,020
	88 (31.1)	SHC	21,050	21,240	21,410	21,470	18,230	11,020
63 (17.2)		TC	25,430	24,710	23,910	23,200	18,670	11,270
	72 (22.2)	SHC	14,920	14,530	14,150	13,770	11,720	8,640
	76 (24.4)	SHC	16,970	16,580	16,200	15,810	13,770	10,690
	80 (26.7)	SHC	19,140	18,760	18,370	17,990	15,940	11,270
	84 (28.9)	SHC	21,190	20,810	20,420	20,170	17,990	11,270
	88 (31.1)	SHC	23,240	22,980	22,470	22,210	18,670	11,270
67 (19.4)		TC	26,410	25,690	24,890	# 24,200	19,060	11,490
	72 (22.2)	SHC	12,230	11,970	11,590	11,330	9,160	6,340
	76 (24.4)	SHC	14,410	14,020	13,640	13,380	11,210	8,390
	80 (26.7)	SHC	16,580	16,200	15,810	15,560	13,380	10,570
	84 (28.9)	SHC	18,630	18,250	17,860	17,610	15,430	11,490
	88 (31.1)	SHC	20,680	20,290	20,040	19,650	17,480	11,490
71 (21.7)		TC	27,350	26,640	25,840	25,180	19,390	11,670
	72 (22.2)	SHC	9,540	9,160	8,900	8,640	6,470	3,780
	76 (24.4)	SHC	11,590	11,330	10,950	10,690	8,520	5,830
	80 (26.7)	SHC	13,770	13,380	13,130	12,870	10,690	8,000
	84 (28.9)	SHC	15,810	15,560	15,170	14,920	12,740	10,180
	88 (31.1)	SHC	17,860	17,610	17,220	16,970	14,790	11,670
75 (23.9)		TC	28,120	27,420	26,630	26,020	19,600	11,790
	76 (24.4)	SHC	8,900	8,640	8,260	8,130	5,960	3,520
	80 (26.7)	SHC	10,950	10,690	10,440	10,310	8,130	5,700
	84 (28.9)	SHC	13,130	12,870	12,490	12,360	10,180	7,750
	88 (31.1)	SHC	15,170	14,920	14,660	14,410	12,230	9,800

TC : Total Cooling Capacity (BTU/h) SHC : Sensible Heat Capacity (BTU/h)

NOTE

- Rating conditions (#) : Indoor Unit Entering Air Temp. 80 °F (26.7 °C) DB / 67 °F (19.4 °C) WB
: Outdoor Ambient Temp. 95 °F (35 °C) DB
- Above data does not take Freeze Prevention Protection during cooling operation into account.
For this reason, the value may vary from the actual cooling characteristics.
- Above data represents the value when the operation frequency of a compressor is fixed.

5-3. Cooling Capacity (Low Ambient)

Indoor Unit : **CS-KS18NKU**

Outdoor Unit : **CU-KS18NKUA**

Power Supply : 230V Single Phase 60Hz

< Cooling Capacity (Low Ambient) >

RATING CAPACITY: 17,500 BTU/h			AIR FLOW RATE: 524 CFM						
INDOOR		OUTDOOR							
ENT. TEMP. °F (°C)		AMBIENT TEMP. °F (°C)							
WB	DB		0 (-17.8)	5 (-15.0)	15 (-9.4)	25 (-3.9)	35 (1.7)	45 (7.2)	55 (12.8)
59 (15.0)		TC	15,050	15,040	15,010	15,140	15,200	15,260	15,230
	72 (22.2)	SHC	11,790	11,790	11,790	15,140	11,890	11,890	11,890
	76 (24.4)	SHC	13,520	13,520	13,520	15,140	13,620	13,620	13,620
	80 (26.7)	SHC	15,050	15,040	15,010	15,140	15,200	15,260	15,230
	84 (28.9)	SHC	15,050	15,040	15,010	15,140	15,200	15,260	15,230
	88 (31.1)	SHC	15,050	15,040	15,010	15,140	15,200	15,260	15,230
63 (17.2)		TC	15,050	15,050	15,090	15,350	15,480	15,620	15,640
	72 (22.2)	SHC	9,550	9,550	9,550	15,350	9,760	9,860	9,860
	76 (24.4)	SHC	11,280	11,280	11,280	15,350	11,490	11,490	11,590
	80 (26.7)	SHC	13,110	13,110	13,110	15,350	13,220	13,320	13,320
	84 (28.9)	SHC	14,740	14,740	14,840	15,350	14,950	15,050	15,050
	88 (31.1)	SHC	15,050	15,050	15,090	15,350	15,480	15,620	15,640
67 (19.4)		TC	14,890	14,920	15,040	15,460	15,680	15,910	16,000
	72 (22.2)	SHC	7,210	7,210	7,320	15,460	7,520	7,620	7,720
	76 (24.4)	SHC	8,940	8,940	9,050	15,460	9,250	9,350	9,450
	80 (26.7)	SHC	10,780	10,780	10,880	15,460	11,080	11,180	11,180
	84 (28.9)	SHC	12,500	12,500	12,500	15,460	12,810	12,910	12,910
	88 (31.1)	SHC	14,230	14,230	14,230	15,460	14,540	14,640	14,640
71 (21.7)		TC	14,550	14,610	14,820	15,440	15,780	16,120	16,290
	72 (22.2)	SHC	4,880	4,880	4,880	15,440	5,280	5,380	5,490
	76 (24.4)	SHC	6,500	6,600	6,600	15,440	7,010	7,110	7,210
	80 (26.7)	SHC	8,330	8,330	8,440	15,440	8,740	8,940	8,940
	84 (28.9)	SHC	10,060	10,060	10,160	15,440	10,470	10,670	10,670
	88 (31.1)	SHC	11,790	11,790	11,890	15,440	12,200	12,300	12,400
75 (23.9)		TC	14,050	14,130	14,450	15,300	15,760	16,210	16,470
	76 (24.4)	SHC	4,260	4,260	4,370	15,300	4,770	4,880	4,980
	80 (26.7)	SHC	5,990	6,100	6,200	15,300	6,600	6,710	6,810
	84 (28.9)	SHC	7,720	7,830	7,930	15,300	8,330	8,440	8,540
	88 (31.1)	SHC	9,450	9,450	9,550	15,300	10,060	10,160	10,270

TC : Total Cooling Capacity (BTU/h) SHC : Sensible Heat Capacity (BTU/h)

NOTE

1. Above data does not take Freeze Prevention Protection during cooling operation into account. For this reason, the value may vary from the actual cooling characteristics.
2. Above data represents the value when the operation frequency of a compressor is fixed.

Indoor Unit : **CS-KS24NKU**
 Outdoor Unit : **CU-KS24NKUA**
 Power Supply : 230V Single Phase 60Hz

< Cooling Capacity (Low Ambient) >

RATING CAPACITY:		24,200 BTU/h		AIR FLOW RATE:		659 CFM			
INDOOR			OUTDOOR						
ENT. TEMP. °F (°C)			AMBIENT TEMP. °F (°C)						
WB	DB		0 (-17.8)	5 (-15.0)	15 (-9.4)	25 (-3.9)	35 (1.7)	45 (7.2)	55 (12.8)
59 (15.0)		TC	21,090	21,110	20,980	21,210	21,150	21,090	21,140
	72 (22.2)	SHC	15,690	15,690	15,690	20,420	15,690	15,690	15,690
	76 (24.4)	SHC	17,730	17,730	17,730	21,210	17,860	17,730	17,730
	80 (26.7)	SHC	19,910	19,910	19,910	21,210	19,910	19,910	19,910
	84 (28.9)	SHC	21,090	21,110	20,980	21,210	21,150	21,090	21,140
	88 (31.1)	SHC	21,090	21,110	20,980	21,210	21,150	21,090	21,140
63 (17.2)		TC	20,960	21,020	21,030	21,460	21,460	21,470	21,630
	72 (22.2)	SHC	12,740	12,740	12,740	20,420	13,000	13,000	13,130
	76 (24.4)	SHC	14,790	14,920	14,920	21,460	15,050	15,050	15,170
	80 (26.7)	SHC	16,970	16,970	16,970	21,460	17,220	17,220	17,350
	84 (28.9)	SHC	19,010	19,140	19,140	21,460	19,270	19,270	19,400
	88 (31.1)	SHC	20,960	21,020	21,030	21,460	21,320	21,320	21,450
67 (19.4)		TC	20,600	20,700	20,890	21,570	21,640	21,750	22,020
	72 (22.2)	SHC	9,800	9,800	9,930	20,420	10,180	10,310	10,310
	76 (24.4)	SHC	11,850	11,850	11,970	21,570	12,230	12,360	12,490
	80 (26.7)	SHC	14,020	14,020	14,150	21,570	14,410	14,530	14,660
	84 (28.9)	SHC	16,070	16,070	16,200	21,570	16,580	16,580	16,710
	88 (31.1)	SHC	18,120	18,250	18,250	21,570	18,630	18,630	18,760
71 (21.7)		TC	19,950	20,090	20,520	21,510	21,680	21,880	22,310
	72 (22.2)	SHC	6,600	6,720	6,850	20,420	7,240	7,360	7,490
	76 (24.4)	SHC	8,770	8,770	8,900	21,510	9,410	9,410	9,540
	80 (26.7)	SHC	10,820	10,950	11,080	21,510	11,460	11,590	11,720
	84 (28.9)	SHC	13,000	13,000	13,130	21,510	13,640	13,640	13,890
	88 (31.1)	SHC	15,050	15,050	15,300	21,510	15,690	15,690	15,940
75 (23.9)		TC	19,060	19,240	19,940	21,270	21,540	21,860	22,440
	76 (24.4)	SHC	5,700	5,830	6,080	21,270	6,600	6,600	6,850
	80 (26.7)	SHC	7,880	8,000	8,130	21,270	8,770	8,770	9,030
	84 (28.9)	SHC	9,930	10,050	10,310	21,270	10,820	10,950	11,080
	88 (31.1)	SHC	12,100	12,100	12,360	21,270	12,870	13,000	13,130

TC : Total Cooling Capacity (BTU/h) SHC : Sensible Heat Capacity (BTU/h)

NOTE

1. Above data does not take Freeze Prevention Protection during cooling operation into account. For this reason, the value may vary from the actual cooling characteristics.
2. Above data represents the value when the operation frequency of a compressor is fixed.

5-4. Air Throw Distance Charts

Indoor Unit **CS-KS18NKU**

Cooling Room air temp. : 80°F (26.7°C)
 Fan speed : High

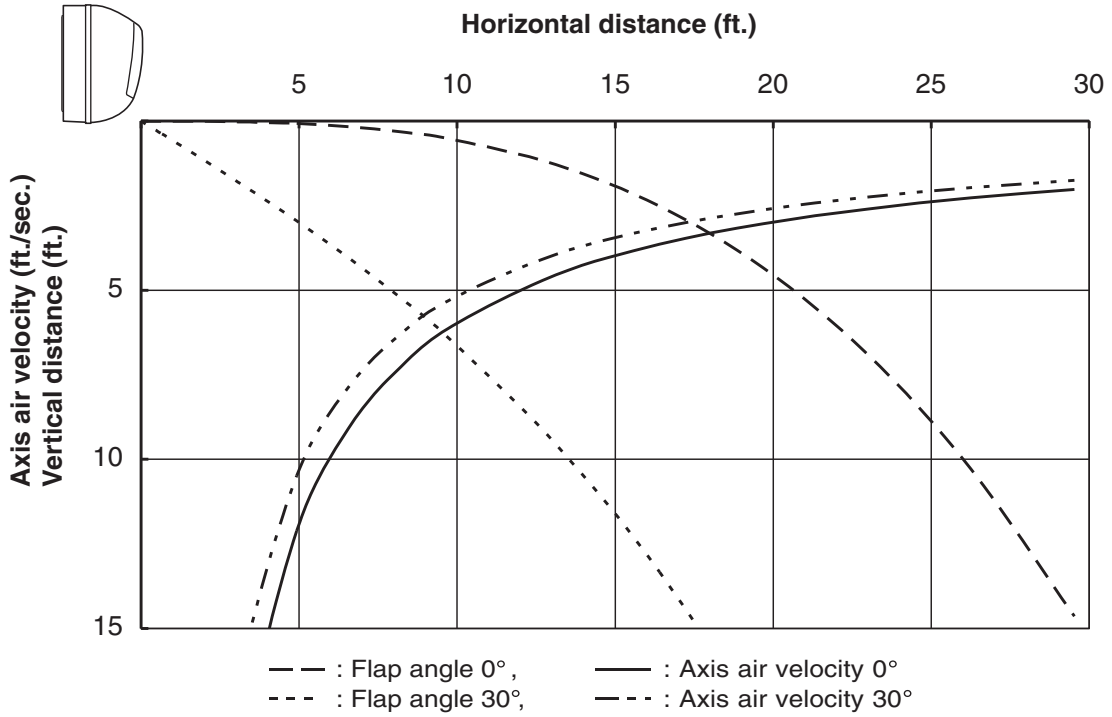

Cooling Room air temp. : 80°F (26.7°C)
Fan speed : High

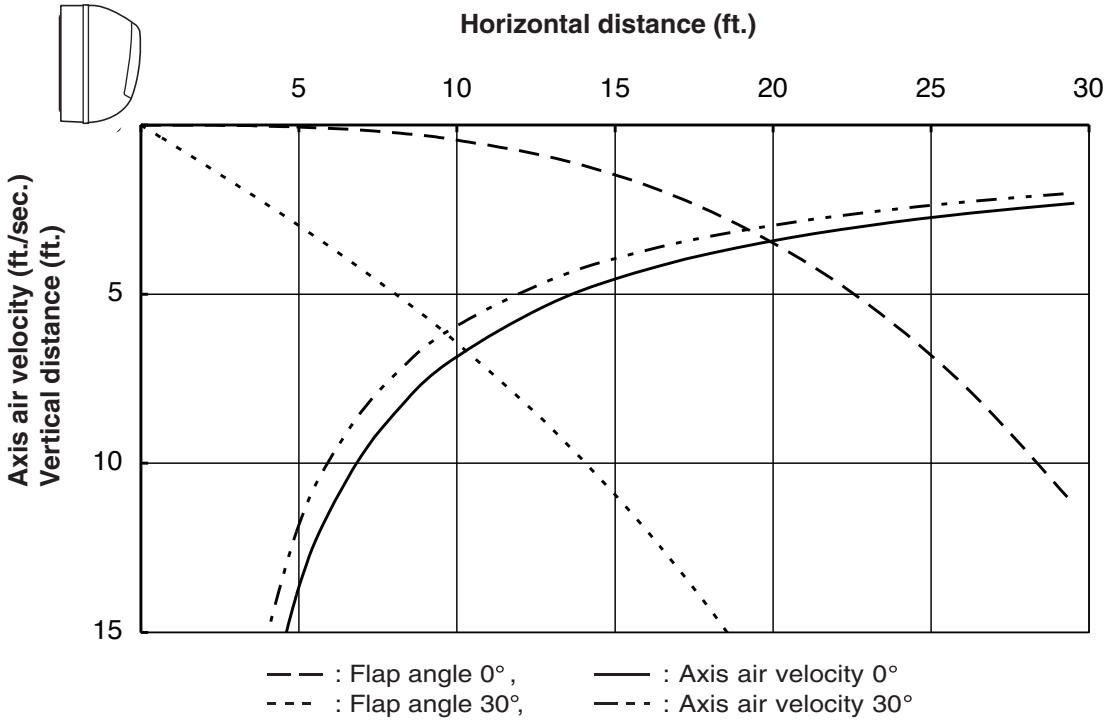

6. ELECTRICAL DATA

6-1. Electrical Characteristics

Indoor Unit **CS-KS18NKU**

Outdoor Unit **CU-KS18NKU**

Cooling

< 230V >

			Indoor Unit	Outdoor Unit	Complete Unit
			Fan Motor	Fan Motor + Compressor	
Performance at			230V Single-phase 60Hz		
Rating conditions	Running amp.	A	0.3	6.7	7.0
	Power input	W	32	1,468	1,500

Rating conditions: Indoor air temperature: 80 °F (26.7 °C) DB / 67 °F (19.4 °C) WB

Outdoor air temperature: 95 °F (35 °C) DB

Cooling

< 208V >

			Indoor Unit	Outdoor Unit	Complete Unit
			Fan Motor	Fan Motor + Compressor	
Performance at			208V Single-phase 60Hz		
Rating conditions	Running amp.	A	0.3	7.4	7.7
	Power input	W	32	1,468	1,500

Rating conditions: Indoor air temperature: 80 °F (26.7 °C) DB / 67 °F (19.4 °C) WB

Outdoor air temperature: 95 °F (35 °C) DB

Indoor Unit **CS-KS18NKU**

Outdoor Unit **CU-KS18NKUA**

Cooling

< 230V >

			Indoor Unit	Outdoor Unit	Complete Unit
			Fan Motor	Fan Motor + Compressor	
Performance at			230V Single-phase 60Hz		
Rating conditions	Running amp.	A	0.3	6.7	7.0
	Power input	W	32	1,468	1,500

Rating conditions: Indoor air temperature: 80 °F (26.7 °C) DB / 67 °F (19.4 °C) WB

Outdoor air temperature: 95 °F (35 °C) DB

Cooling

< 208V >

			Indoor Unit	Outdoor Unit	Complete Unit
			Fan Motor	Fan Motor + Compressor	
Performance at			208V Single-phase 60Hz		
Rating conditions	Running amp.	A	0.3	7.4	7.7
	Power input	W	32	1,468	1,500

Rating conditions: Indoor air temperature: 80 °F (26.7 °C) DB / 67 °F (19.4 °C) WB

Outdoor air temperature: 95 °F (35 °C) DB

Indoor Unit **CS-KS24NKU**
 Outdoor Unit **CU-KS24NKU**

Cooling

< 230V >

			Indoor Unit	Outdoor Unit	Complete Unit
			Fan Motor	Fan Motor + Compressor	
Performance at			230V Single-phase 60Hz		
Rating conditions	Running amp.	A	0.5	10.3	10.8
	Power input	W	55	2,405	2,460

Rating conditions: Indoor air temperature: 80 °F (26.7 °C) DB / 67 °F (19.4 °C) WB
 Outdoor air temperature: 95 °F (35 °C) DB

Cooling

< 208V >

			Indoor Unit	Outdoor Unit	Complete Unit
			Fan Motor	Fan Motor + Compressor	
Performance at			208V Single-phase 60Hz		
Rating conditions	Running amp.	A	0.5	11.6	12.1
	Power input	W	55	2,405	2,460

Rating conditions: Indoor air temperature: 80 °F (26.7 °C) DB / 67 °F (19.4 °C) WB
 Outdoor air temperature: 95 °F (35 °C) DB

Indoor Unit **CS-KS24NKU**
 Outdoor Unit **CU-KS24NKUA**

Cooling

< 230V >

			Indoor Unit	Outdoor Unit	Complete Unit
			Fan Motor	Fan Motor + Compressor	
Performance at			230V Single-phase 60Hz		
Rating conditions	Running amp.	A	0.5	10.3	10.8
	Power input	W	55	2,405	2,460

Rating conditions: Indoor air temperature: 80 °F (26.7 °C) DB / 67 °F (19.4 °C) WB
 Outdoor air temperature: 95 °F (35 °C) DB

Cooling

< 208V >

			Indoor Unit	Outdoor Unit	Complete Unit
			Fan Motor	Fan Motor + Compressor	
Performance at			208V Single-phase 60Hz		
Rating conditions	Running amp.	A	0.5	11.6	12.1
	Power input	W	55	2,405	2,460

Rating conditions: Indoor air temperature: 80 °F (26.7 °C) DB / 67 °F (19.4 °C) WB
 Outdoor air temperature: 95 °F (35 °C) DB

6-2. Electric Wiring Diagrams

Indoor Unit CS-KS18NKU CS-KS24NKU



WARNING

To avoid electrical shock hazard, be sure to disconnect power before checking, servicing and/or cleaning any electrical parts.

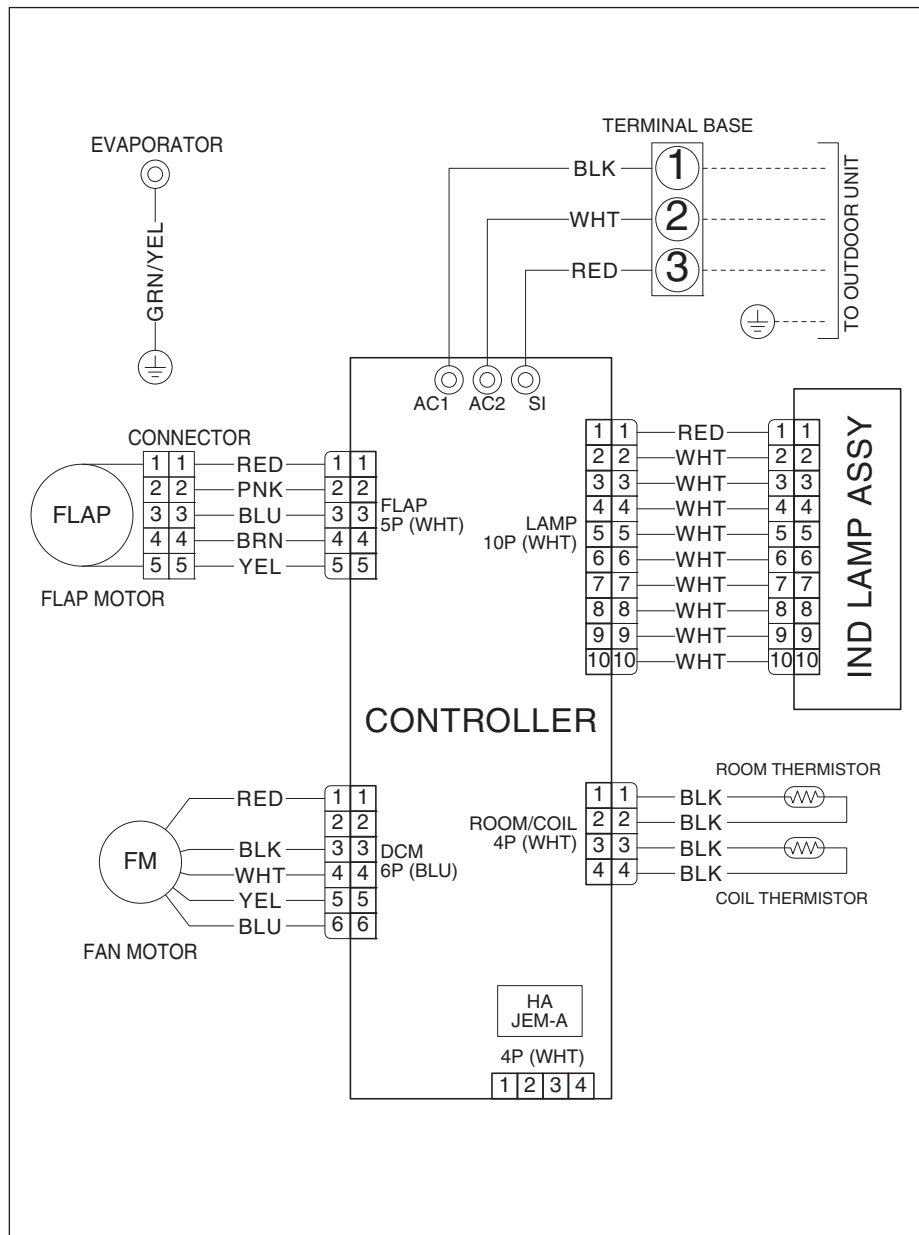

8FA2-5251-11000-2



WARNING

To avoid electrical shock hazard, be sure to disconnect power before checking, servicing and/or cleaning any electrical parts.

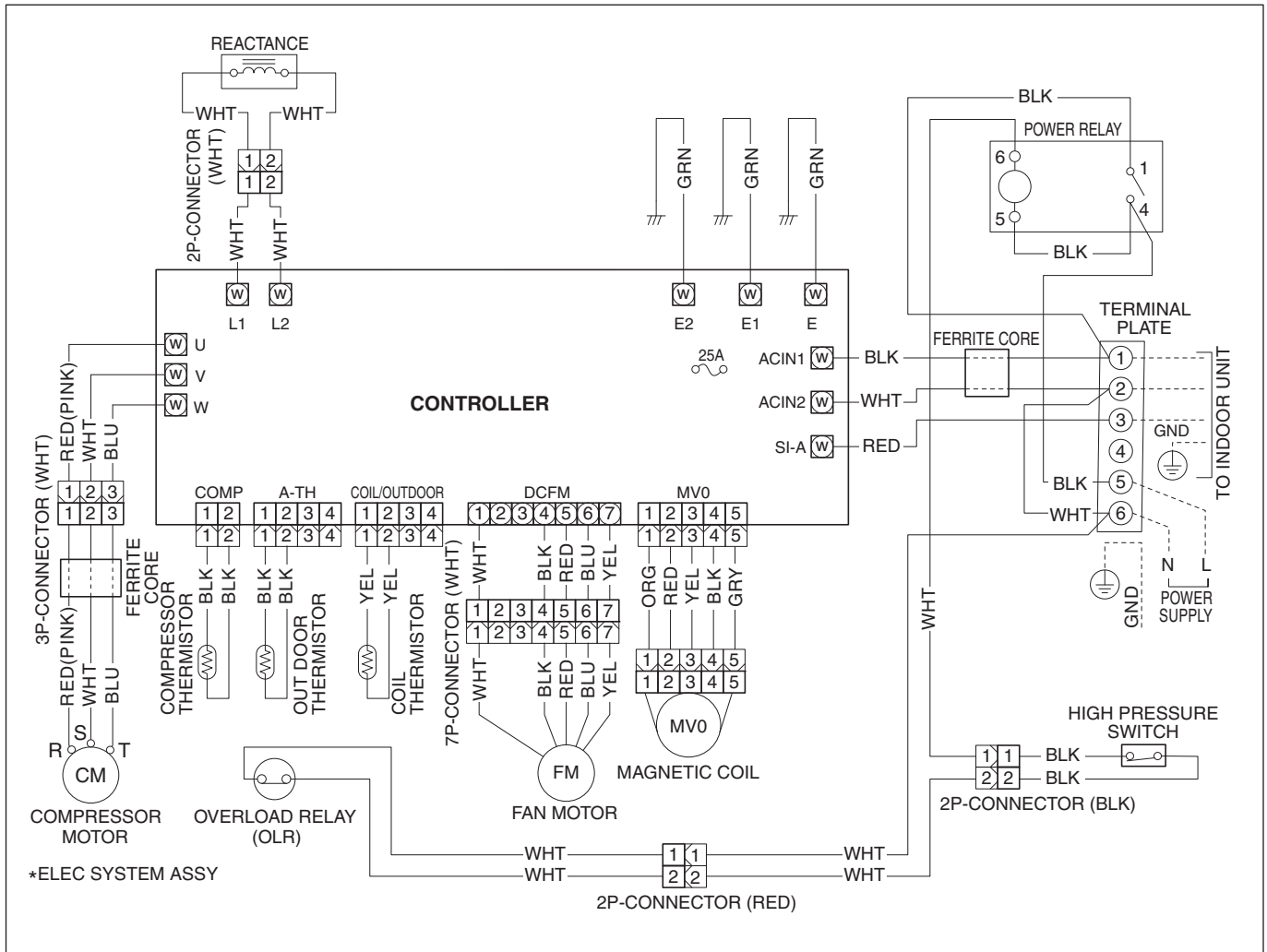

8FA2-5251-12000-2



WARNING

To avoid electrical shock hazard, be sure to disconnect power before checking, servicing and/or cleaning any electrical parts.

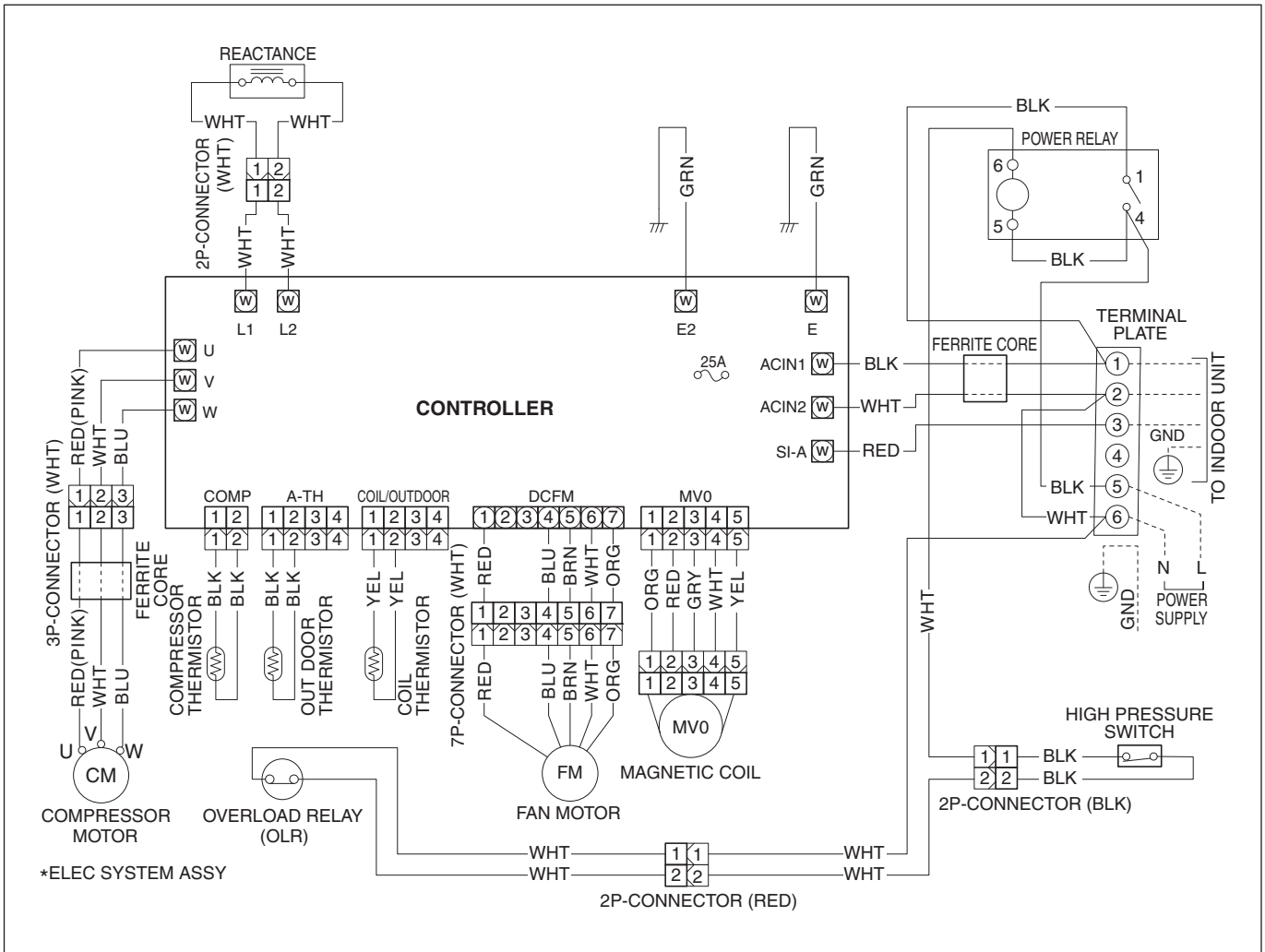

8FA2-5251-12800-2



WARNING

To avoid electrical shock hazard, be sure to disconnect power before checking, servicing and/or cleaning any electrical parts.

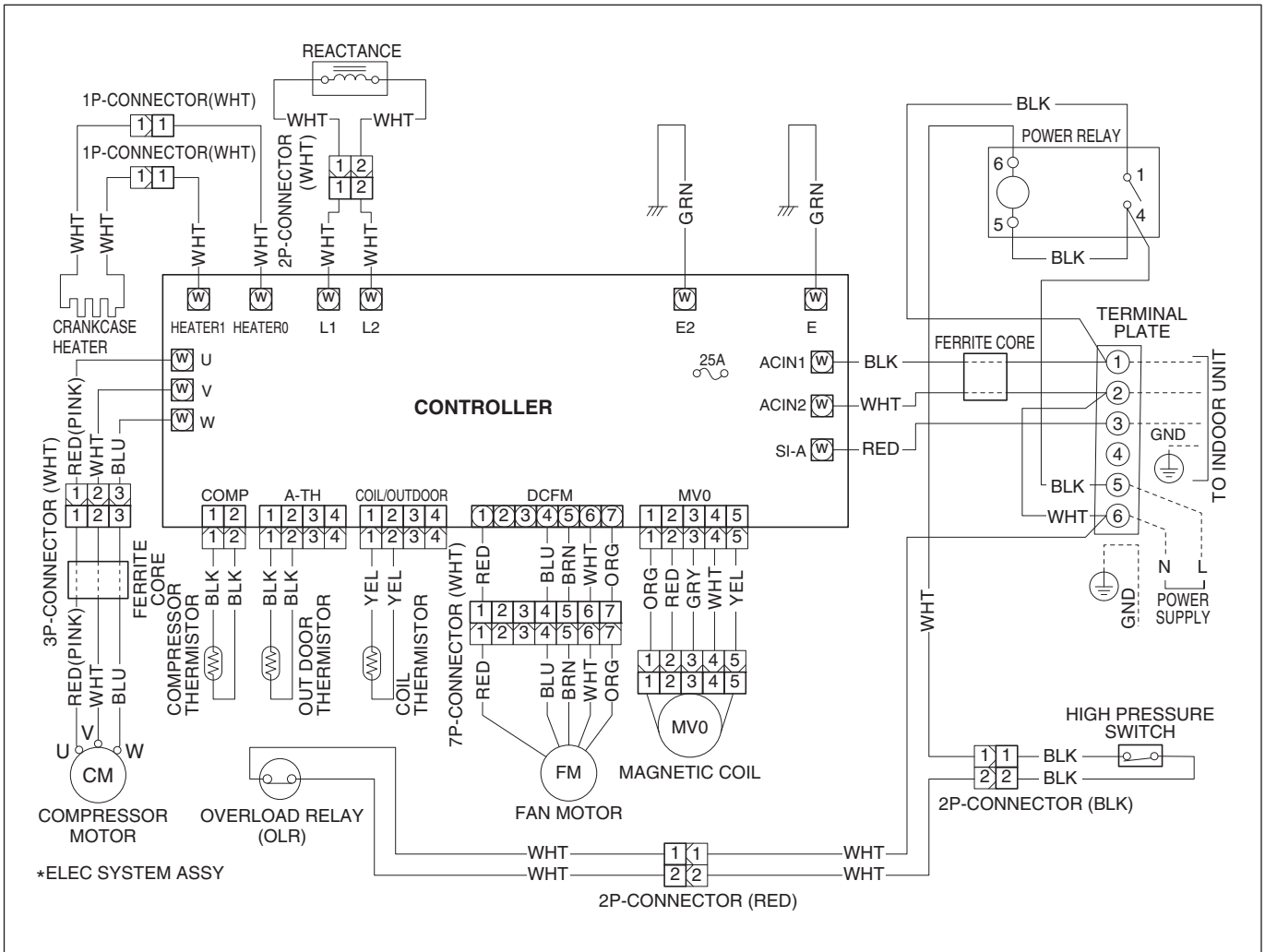

8FA2-5251-12700-2

7. MAINTENANCE

7-1. Address Setting of the Remote Control Unit

The address can be set in order to prevent interference between remote controllers when two Sanyo indoor units are installed near each other. The address is normally set to "A." To set a different address, it is necessary to change the address on the second remote controller.

NOTE

Once changed, you cannot restore the original address setting of the air conditioner.

- (1) Switch on the power source.
- (2) Break the address-setting tab marked "A" on the second remote controller to change the address (Fig. 1). When the tab is removed, the address is automatically set to B (Fig. 2).
- (3) Press and hold the remote controller QUIET button and 1 HR TIMER button. Then, press and hold the ACL (reset) button with a pointed object such as the tip of a pen. After 5 seconds, release ACL button first, then release QUIET and 1 HR TIMER buttons, "oP-1" (test run) appears, blinking in the remote controller clock display area.
- (4) Each time the 1 HR TIMER button is pressed, the display changes as shown below. Press this button 2 times to change the display to "oP-7" (address setting). (Fig. 3)

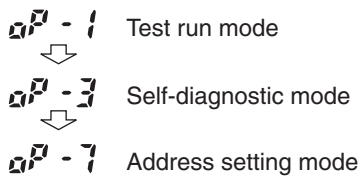

- (5) "oP-7" has now been selected for address setting.
- (6) Press the ON/OFF operation button on the remote controller. (Fig. 3) Check that the "beep" signal-received sound is heard from the second indoor unit (approximately 5 times). The sound you hear is the signal that the remote controller address has been changed.
- (7) Finally press the remote controller ACL (reset) button to cancel the blinking "oP-7" display. (Fig. 3)

Changing of the second remote controller address is now completed.

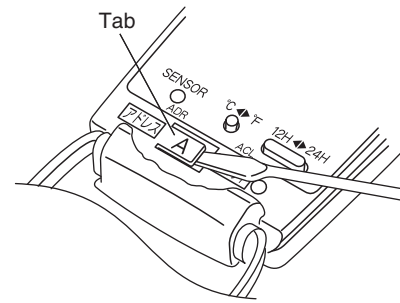

Fig. 1

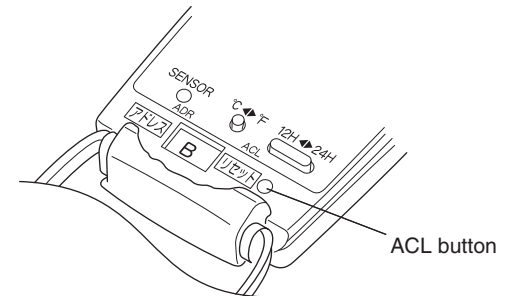

Fig. 2

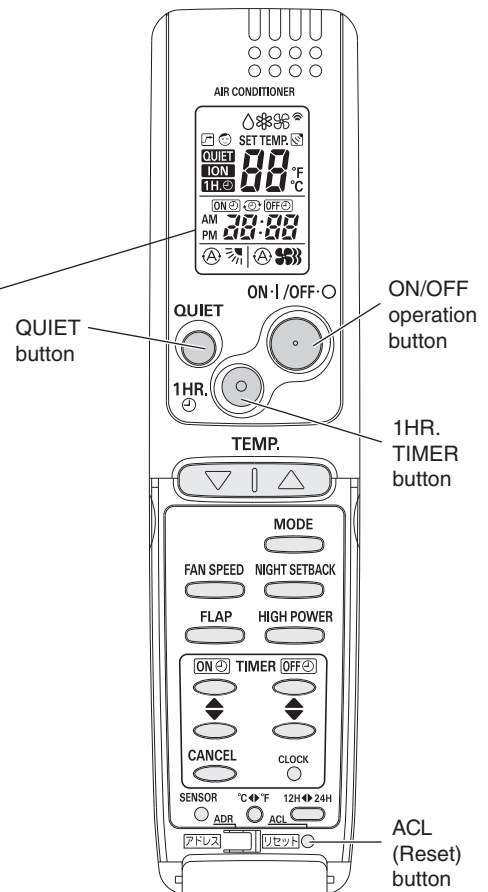
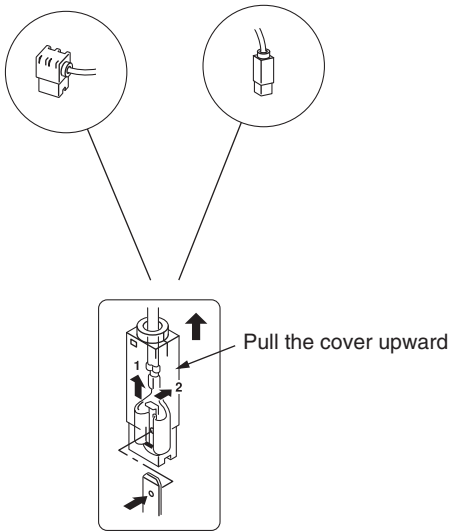

Fig. 3

7-2. Disconnecting and Connecting Positive Connector for Outdoor Unit



When the cover is pulled upward, the lock is released with the sequence of 1 and 2.

One of the two types of connectors illustrated at left is used. Their basic structure is the same for each.

How to Disconnect

Hold the resin connector cover, and pull the connector off. You cannot disconnect the connector by pulling the wire since it is locked inside. Always hold the cover to disconnect. (See illustration at left.) For the connector without the resin cover, push the lock in the direction of "2" while pulling it off.

How to Connect

In order to connect, hold the resin cover of the connector and push it in. Confirm the click sound for the inside lock.

8. FUNCTIONS

8-1. Operation Functions

■ Emergency operation

Emergency operation is available when the remote controller malfunctions, has been lost, or otherwise cannot be used.

To operate the system, press the OPERATION button, which is also used as the receiver, below the unit display. Each time this button is pressed, the OPERATION lamp changes color to indicate the type of operation. Select the desired type of operation.



- The set temperature is 4°F(2°C) below the detected room temperature in the case of cooling operation.

■ SENSOR DRY

During DRY operation, the system adjusts the room temperature and fan speed according to the conditions in the room, in order to maintain a comfortable room environment.

SENSOR DRY operation

- DRY operation is as shown in the figure below.

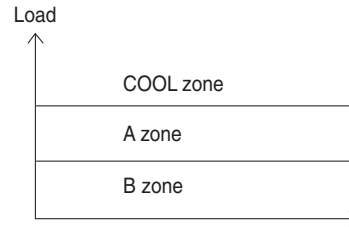

Conditions are monitored at all times when the room temperature is below 59°F(15°C).

DRY A

The compressor operation frequency varies.
The indoor fan operates with 1/f fluctuation.

DRY B

The compressor operates at a low operating frequency.
The indoor fan operates with 1/f fluctuation.

Monitor

- Monitoring operation takes place when the room temperature is below 59°F(15°C), or more than 5°F(3°C) below the set temperature.
- When the monitoring range is entered, the compressor stops, and the indoor fan operates with 1/f fluctuation.

NOTE (CLxx models only)

The Sensor Dry operation during the Low Ambient Cooling Mode (outside air temperature:59°F(15°C) or lower) is as follows.

DRY A and DRY B

The compressor operates a cycle of 3 minutes ON and 6 minutes OFF repeatedly.

■ PAM-α control

- In order to further improve inverter performance, control is switched between PWM control at low operation speeds, and PAM control at high operation speeds, making the most effective use of power.

■ HIGH POWER

This function acts to raise the power but keeps the AC system in the same operating mode.

This function is set with the HIGH POWER button on the remote controller.

(It can be set regardless of the temperature and fan speed settings.)

● HIGH POWER operation from remote controller

The unit operates at maximum output for 30 minutes, regardless of the desired temperature.

The fan speed is 1 step above "High."

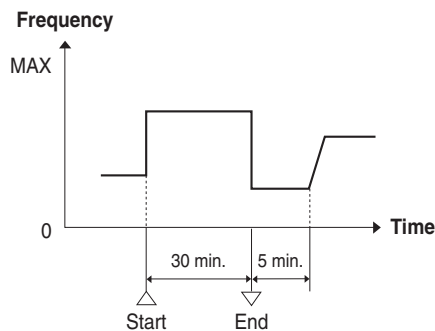

NOTE

- When HIGH POWER operation ends, the unit operates at low Hz for 5 minutes, regardless of the thermostat OFF conditions.
- When in DRY mode, operation is in the cooling zone.

■ NIGHT SETBACK

• When NIGHT SETBACK operation is set, the temperature and fan speed settings will be adjusted automatically to allow comfortable sleep.

• When NIGHT SETBACK operation is set, "☺" mark appears on the remote controller. The main unit display lamp also becomes dimmer.

● COOL and DRY modes

When the night setback mode is selected, the air conditioner automatically raises the temperature setting $2^{\circ}\text{F}(1^{\circ}\text{C})$ when 30 minutes have passed after the selection was made, and then another $2^{\circ}\text{F}(1^{\circ}\text{C})$ after another 30 minutes have passed, regardless of the indoor temperature when night setback was selected. This enables you to save energy without sacrificing comfort. This function is convenient when gentle cooling is needed.

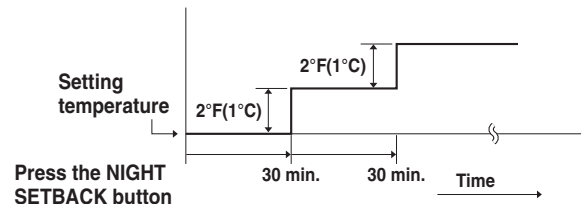

■ Lamp colors

OPERATION lamp

DRY operation	Orange
COOL operation	Green
FAN operation	Green

TIMER lamp

Green

QUIET lamp

Green

■ Timer backup

- Operation stops if there are no operator controls for 25 hours or longer after unit operation switched from OFF to ON by use of ON timer operation.

8-2. Protective Functions

Freeze prevention

During COOL or DRY operation, freezing is detected and operation is stopped when the temperature of the indoor heat exchanger matches the conditions below.

- Freeze-prevention operation is engaged when the temperature of the indoor heat exchanger is below 43°F(6°C).
- Restart after freeze-prevention operation occurs when the temperature of the indoor heat exchanger reaches 46°F(8°C) or above.

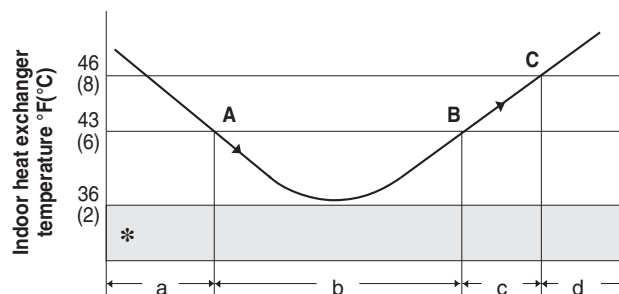

- Area: Automatic capacity control
- When the temperature drops below Point A, the operation frequency is reduced by a certain proportion.
- Area: Frequency increase is prohibited.
- When the temperature reaches Point C or above, freezing prevention is ended and control is the same as in the a area.

* When the temperature drops to below 36°F(2°C) (continuously for 2 minutes or longer), the compressor stops. Once the freeze condition is detected, the air conditioner will work less than the maximum frequency until it is turned off.

NOTE (CLxx models only)

The Freeze Prevention Control during the Low Ambient Cooling Mode (outside air temperature:59°F(15°C) or lower) is as follows.

- The compressor stops when the temperature of indoor heat exchanger becomes less than 36°F(2°C).
- The compressor restarts when the temperature of indoor heat exchanger becomes 46°F(8°C) or higher.

Compressor discharge temperature control

This function controls the operation frequency to prevent the compressor discharge temperature from rising more than a specified temperature.

Compressor discharge temperature °F(°C)

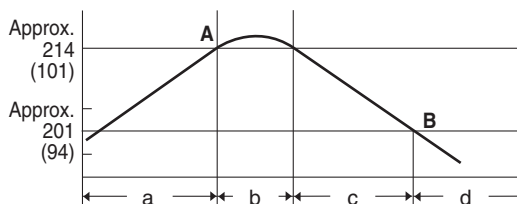

- Area: Automatic capacity control.
- When the temperature rises above Point A, the operation frequency is reduced at a specified rate.
- Area: Further frequency increase is prohibited.
- When the temperature falls below Point B, prevention of a rise in frequency is released and the air conditioner operates as in a area.

* The compressor will stop if the temperature of the compressor discharge exceeds 248°F(120°C) due to shortage of gas or other reason.

CT (Peak current cut-off control)

- This function prevents the circuit breaker or fuse from operating to open the circuit. This function works when electrical current has increased due to an increase in the cooling load, or to a decrease in the power supply voltage. In these cases, operation frequency is reduced or operation is interrupted automatically to control the electrical current for operation.
- When the cause of the increase in electrical current is rectified, the system will resume operation in the original mode.

< CS-KS18NKU > (A)

	Cooling • Dry
Peak current cut-off trips	17.5
Hz down	11.0

< CS-KS24NKU > (A)

	Cooling • Dry
Peak current cut-off trips	22.5
Hz down	14.0

9. TROUBLESHOOTING (BEFORE CALLING FOR SERVICE)

9-1. Precautions before Performing Inspection or Repair

- After checking the self-diagnostics monitor, turn the power OFF before starting inspection or repair.
 - High-capacity electrolytic capacitors are used inside the outdoor unit controller (inverter). They retain an electrical charge (charging voltage DC 310V) even after the power is turned OFF, and some time is required for the charge to dissipate. Be careful not to touch any electrified parts before the controller LED (red) turns OFF.
- If the outdoor controller is normal, approximately 30 seconds will be required for the charge to dissipate. However, allow at least 5 minutes for the charge to dissipate if there is thought to be any trouble with the outdoor controller.

9-2. Method of Self-Diagnostics

Follow the procedure below to perform detailed trouble diagnostics.

NOTE

- 1: If the operation lamp blinks every 0.5 seconds immediately when the power is turned ON, there is an external ROM (OTP data) failure on the indoor circuit board, or a ROM socket insertion problem, or the ROM has not been installed.
- 2: The failure mode is stored in memory even when the power is not ON. Follow the procedure below to perform diagnostics.

PROCEDURE

After turning on power to the air conditioner, use the remote controller and follow the steps below to execute self-diagnostics.

- Step 1: Press and hold the remote controller QUIET button and 1 HR TIMER button. Then, press and hold the ACL (reset) button with a pointed object such as the tip of a pen. After 5 seconds, release ACL button first, then release QUIET and 1 HR TIMER buttons, "oP-1" (test run) appears, blinking in the remote controller clock display area.
- Step 2: Next, press the 1 HR TIMER button once to change the display from "oP-1" to "oP-3" (self-diagnostics). (The display continues to blink.)
- Step 3: Finally press the ON/OFF button to engage self-diagnostics mode.

- The self-diagnostics function utilizes the 3 indicator lamps on the main unit, in combinations of ON lamps, blinking lamps, and OFF lamps, to report the existence of sensor trouble or a protective operation. (The lamps blink or remain ON for 5 seconds, then turn OFF for 2 seconds.) Self-diagnostics is completed when the buzzer sounds 3 short beeps.
- A maximum of 3 self-diagnostics reports are displayed, for 5 seconds each, beginning with the most recent report. Following this display the lamps turn OFF. In order to view the self-diagnostics results again, press the ON/OFF button again.
- The 3 lamps remain OFF if no trouble has occurred.

<IMPORTANT> After self-diagnostics is completed, be sure to press the ACL (reset) button to return to normal mode. The air conditioner will not operate if this is not done.

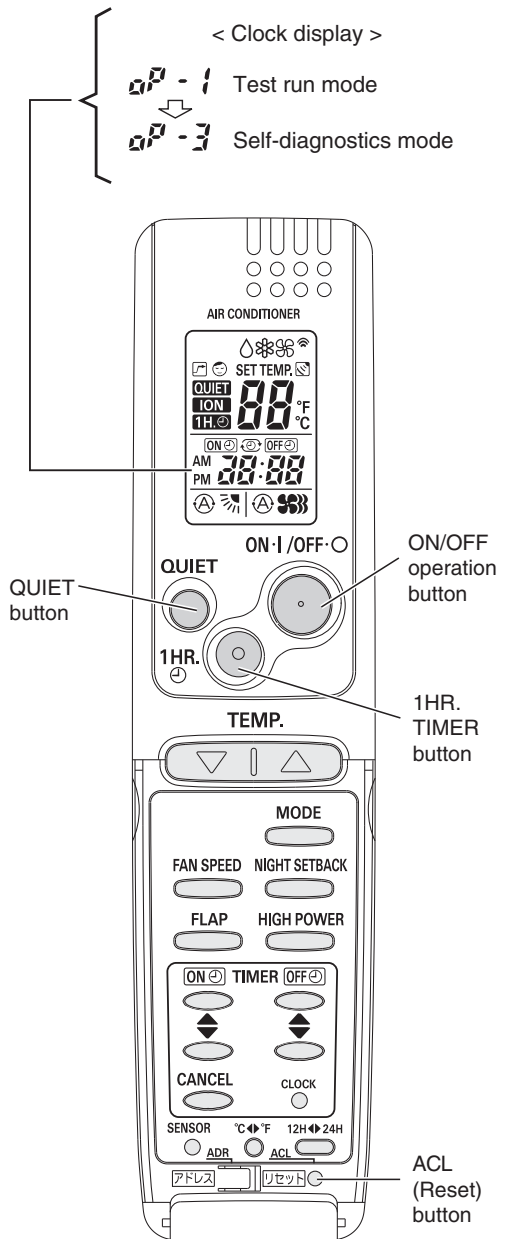

(1) Self-diagnostics Lamps

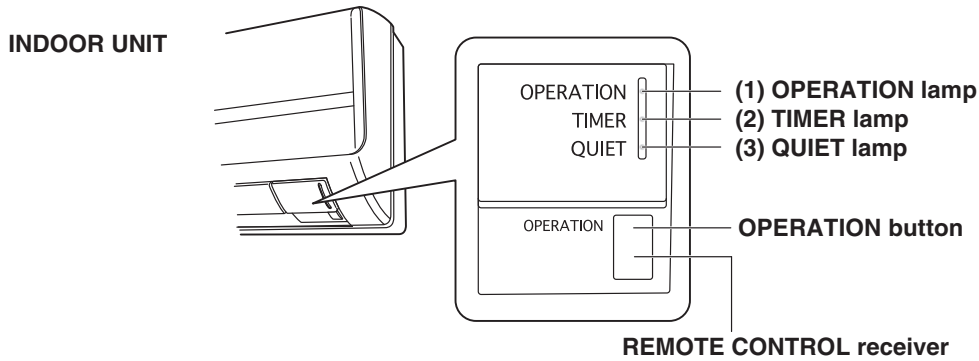

• Since the indications cover various units, the corresponding parts listed below may not be present in some models.

INDICATION ON INDOOR UNIT				✕ ... OFF	◐ ... BLINKING	☀ ... ON	
QUIET (3)	TIMER (2)	OPERATION (1)	CODE	DIAGNOSIS CONTENTS	POSSIBLE MALFUNCTION		
✕	✕	◐	S01	ROOM TEMP. SENSOR TROUBLE	(1) OPEN OR SHORT CIRCUIT IN SENSOR		
✕	◐	✕	S02	I/D HEAT EXCHANGER TEMP. SENSOR TROUBLE	(2) POOR CONTACT AT CONNECTOR OR OPEN CIRCUIT AT TERMINAL PRESS-FIT LOCATION (FOR HUMIDITY SENSOR, THIS REPRESENTS SHORT-CIRCUIT DETECTION ONLY.)		
✕	◐	◐	S03	HUMIDITY SENSOR TROUBLE	(3) I/D PCB FAILURE (I/D = INDOOR)		
◐	✕	✕	S04	COMPRESSOR TEMP. SENSOR TROUBLE	(1) OPEN OR SHORT CIRCUIT IN SENSOR		
◐	✕	◐	S05	O/D HEAT EXCHANGER TEMP. SENSOR TROUBLE	(2) POOR CONTACT AT CONNECTOR OR OPEN CIRCUIT AT TERMINAL PRESS-FIT LOCATION		
◐	◐	✕	S06	O/D AIR TEMP. SENSOR TROUBLE	(3) O/D PCB FAILURE (O/D = OUTDOOR)		
◐	◐	◐	S07	O/D CURRENT SENSOR ERROR	O/D PCB FAILURE		
✕	✕	☀	E01	I/D-O/D COMMUNICATION TROUBLE (SERIAL COMMUNICATION TROUBLE)	(1) MIS-WIRING (2) AC POWER FAILURE (3) BLOWN FUSE (4) POWER RELAY FAILURE (5) I/D OR O/D PCB FAILURE (6) O/D FAN MOTOR FAILURE (7) REACTOR FAILURE (8) HIGH-PRESSURE SW FAILURE (9) OLR FAILURE (10) MAGNETIC COIL FAILURE		
✕	☀	✕	E02	HIC CIRCUIT TROUBLE POWER TR CIRCUIT TROUBLE	(1) HIC OR POWER TR FAILURE (2) O/D FAN NOT OPERATING (3) INSTANTANEOUS POWER STOPPAGE (4) SERVICE VALVE NOT OPENED. (5) O/D FAN BLOCKED (6) CONTINUOUS OVERLOAD OPERATION (7) COMPRESSOR FAILURE (8) O/D PCB FAILURE		
✕	☀	☀	E03	O/D UNIT EXTERNAL ROM TROUBLE	(1) EXTERNAL ROM DATA FAILURE (2) O/D PCB FAILURE		
☀	✕	✕	E04	CURRENT PEAK CUT	(1) INSTANTANEOUS POWER STOPPAGE (2) HIC OR POWER TR FAILURE (3) O/D PCB FAILURE		
☀	✕	☀	E05	PAM CIRCUIT TROUBLE ACTIVE CIRCUIT TROUBLE	(1) O/D PCB FAILURE (2) O/D POWER VOLTAGE TROUBLE		
☀	☀	✕	E06	COMPRESSOR DISCHARGE TEMP. OVERHEATING PREVENTION	(1) ELECTRIC EXPANSION VALVE FAILURE (2) CHOKED CAPILLARY TUBE (3) INSUFFICIENT GAS (4) CONTINUOUS OVERLOAD OPERATION (5) O/D FAN NOT OPERATING (6) O/D PCB FAILURE		
☀	☀	☀	E07	I/D FAN OPERATION TROUBLE	(1) FAN MOTOR FAILURE (2) CONNECTOR CONTACT FAILURE (3) I/D PCB FAILURE		
◐	◐	☀	E08	4-WAY VALVE SWITCHING TROUBLE ZERO-CROSS TROUBLE	(1) 4-WAY VALVE FAILURE (HEAT PUMP MODEL ONLY) (2) O/D PCB FAILURE		
◐	☀	◐	E09	GAS-LOSS PREVENTION	(1) SERVICE VALVE NOT OPENED (2) INSUFFICIENT GAS		
◐	☀	☀	E10	DC COMPRESSOR DRIVE CIRCUIT TROUBLE	(1) OPEN PHASE (2) O/D PCB FAILURE		
☀	◐	◐	E11	O/D DC FAN OPERATION TROUBLE	(1) FAN MOTOR FAILURE (2) CONNECTOR CONTACT FAILURE (3) O/D PCB FAILURE		
☀	◐	☀	E12	O/D SYSTEM COMM FAILURE, OLR OPERATION, O/D POWER OPEN PHASE, O/D FREEZING	(1) MIS-WIRING (2) BLOWN FUSE (3) POWER RELAY FAILURE (4) O/D PCB FAILURE (5) COMPRESSOR FAILURE		
☀	☀	◐	E13	FREEZING-PREVENTION OPERATION	(1) I/D FAN SYSTEM FAILURE (2) INSUFFICIENT GAS (3) OPERATION AT LOW TEMPERATURE		

(2) If the self-diagnostics function fails to operate

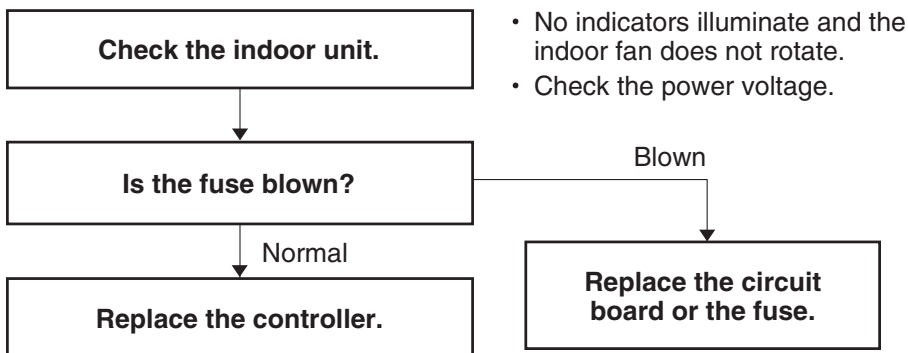

9-3. Checking the Indoor and Outdoor Units

(1) Checking the indoor unit

No.	Control	Check items (unit operation)
1	Use the remote controller to operate the unit in "TEST run" mode. To determine whether the mode is currently in "TEST run" mode, check the 4 indicator lamps on the unit. If all 4 are blinking, the current mode is "TEST run."	<ul style="list-style-type: none"> The rated voltage must be present between inter-unit wirings 1 and 2. Connect a 5 k ohm resistor between inter-unit wirings 2 and 3. When the voltage at both ends is measured, approximately 12 to 15V DC must be output and the multimeter pointer must bounce once every 8 seconds. Or instead of measuring the voltage, you can insert an LED jig and check that the LED flickers once every 8 seconds.

- If there are no problems with the above, then check the outdoor unit.
- For the "Test run" procedure, refer to the Appendix B "Installation Instructions".

(2) Checking the outdoor unit

No.	Control	Check items (unit operation)
1	Apply the rated voltage between outdoor unit terminals L and N.	<ul style="list-style-type: none"> The control panel LED (red) must illuminate.
2	Short-circuit the outdoor unit COM terminal to the T-RUN terminal.	<ul style="list-style-type: none"> The compressor and fan motor must all turn on.

- If there are no problems with the above, then check the indoor unit.

● Using the TEST/T-RUN terminals

- T-RUN : Test run (compressor and fan motor turn ON).
 TEST/MV : Compresses time to 1/60th (accelerates operation by 60 times faster than normal).

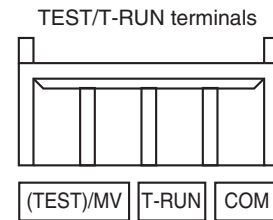

(3) Serial Communication Error Identification Procedure

If the lamps on the main body show the following conditions after the completion of self-diagnostics, a communication error between the indoor unit and outdoor unit might be considered. In such a case, identify the breakdown section by using the following procedure.

NOTE Refer to "Method of Self-Diagnostics" for the self-diagnostics procedure.

Lamp	Quiet (3)	Timer (2)	Operation (1)
E01	×	×	☀
E12	☀	☀	☀

× : Off
 ☀ : Blinking
 ☀ : Illuminated

< Before the Operation >



WARNING

For terminal strip short circuit work or inter-unit wiring removal, turn off the power to avoid an electric shock. Release the terminal strip short circuit after the completion of self-diagnostics.



CAUTION

Do not perform the short-circuit work between any other terminals except for specified ones on the specified terminal strip. If such work is performed between the incorrect terminals, the unit might be broken.

< Convenient Tool for Short-Circuit Work (for example) >

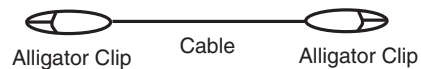

< Check Items before Troubleshooting Serial Communication Start >

After confirming that the following errors do not exist, start the "Troubleshooting Serial Communication" in "Condition: E01 and E12".

- | | |
|---|--|
| 1. Mis -wiring (inter-unit cable, etc.) | 6. Reactor failure (defective insulation, etc.) |
| 2. AC power failure | 7. High-Pressure Switch failure |
| 3. Blown fuse | 8. Overload Relay failure |
| 4. Power Relay failure | 9. Magnetic Coil failure (defective insulation, short-circuit, etc.) |
| 5. Outdoor Fan Motor failure (defective insulation, etc.) | 10. Compressor failure (defective insulation, etc.) |

(3-1) Condition: E01

Troubleshooting Serial Communication

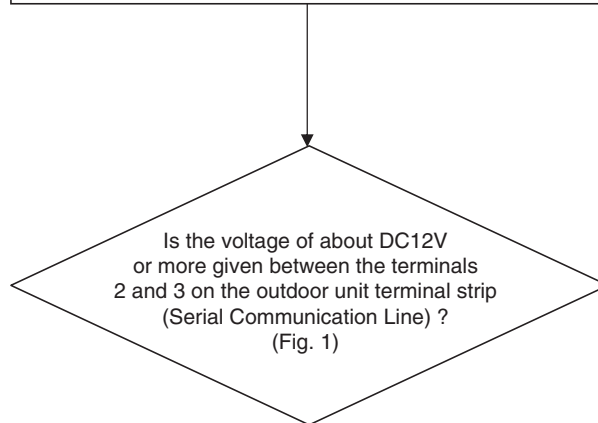

(Continued to the next page A.)

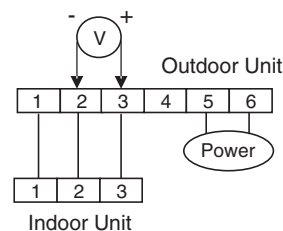

Fig. 1

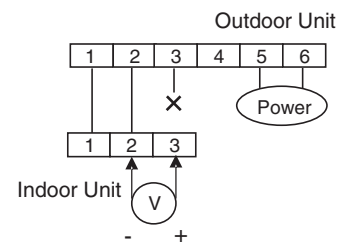

Fig. 2

1. Turn OFF the power and wait until the power lamp (LED) of the outdoor unit controller is turned OFF.
2. Disconnect the cable from the terminal 3 on the indoor unit terminal strip. (Fig. 2)
3. Turn ON the power.

B

(Continued to the next page B.)

(Continued from the previous page A.)

(Continued from the previous page B.)

A

B

Yes

No

Defect or connection error in the inter-unit cable

Defect in the indoor unit P.C. board

1. Turn OFF the power and wait until the power lamp (LED) of the outdoor unit controller is turned OFF.
 2. Short-circuit between the terminals 2 and 3 on the outdoor unit terminal strip. (Fig. 3)

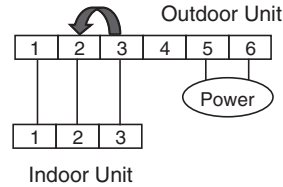
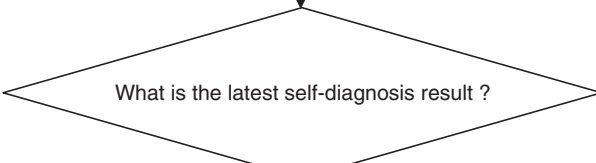

Fig. 3

1. Turn ON the power and operate the system using the remote controller or the operation button on the indoor unit.
 2. Perform the self-diagnosis five seconds after the operation start.



Condition: E12

Defect in the outdoor unit P.C. board.

Condition: E01

1. Turn off the power and wait until the power lamp (LED) of the outdoor unit controller is turned OFF.
 2. Remove the short-circuit between the terminals 2 and 3 on the outdoor unit terminal strip.
 3. Disconnect the cable from the terminal 3 on the indoor unit terminal strip. (Fig. 4)

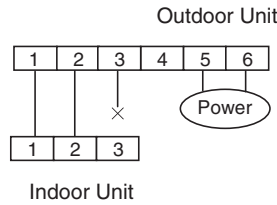

Fig. 4

Short-circuit between the terminals 2 and 3 on the indoor unit terminal board. (Fig. 5)

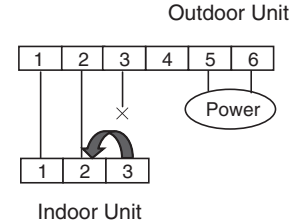
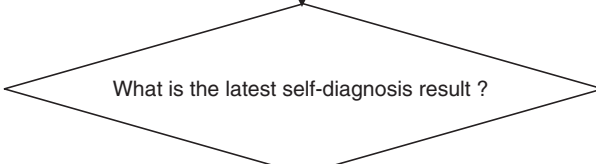

Fig. 5

1. Turn ON the power and operate the system using the remote controller or the operation button on the indoor unit.
 2. Perform the self-diagnosis five seconds after the operation start.



Condition: E12

Defect or connection error in the inter-unit cable

Condition: E01

Defect in the indoor unit P.C. board

(3-2) Condition: E12

Troubleshooting Serial Communication

1. Turn off the power and wait until the power lamp (LED) of the outdoor unit controller is turned OFF.
2. Disconnect the cable from the terminal 3 on the Outdoor unit terminal strip. (Fig. 6)

1. Turn ON the power and operate the system using the remote controller or the operation button on the indoor unit.
2. Perform the self-diagnosis five seconds after the operation start.

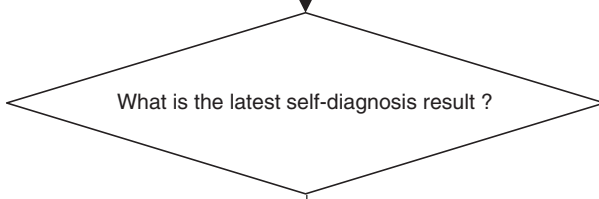

Condition: E01 → Defect in the outdoor unit P.C. board

Condition: E12

1. Turn off the power and wait until the power lamp (LED) of the outdoor unit controller is turned OFF.
2. Disconnect the cable from the terminal 3 on the indoor unit terminal strip. (Fig. 7)

1. Turn ON the power and operate the system using the remote controller or the operation button on the indoor unit.
2. Perform the self-diagnosis five seconds after the operation start.

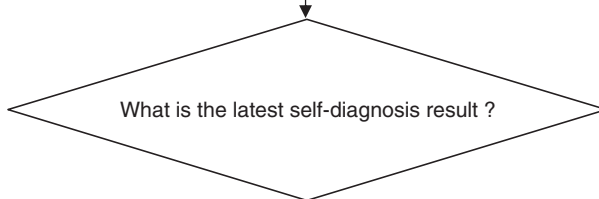

Condition: E01 → Defect in the inter-unit cable

Condition: E12

Defect in the indoor unit P.C. board

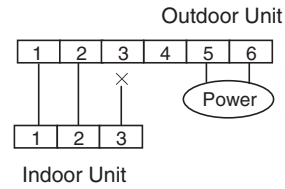

Fig. 6

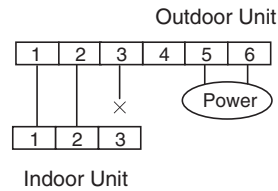

Fig. 7

9-4. Trouble Diagnosis of Fan Motor

9-4-1. Indoor Fan Motor

- This indoor DC fan motor contains an internal control PCB. Therefore, it is not possible to measure the coil resistance, and the following procedure should be used to check the motor.
- To perform diagnosis, operate the unit in cooling mode with indoor fan speed "High". Next, make sure that the indoor unit receive the signals from the remote controller when the ON/OFF operation button is pressed.

Important: (A) Turn OFF the power before connecting or disconnecting the motor connectors.
(B) When performing voltage measurement at the indoor controller connector for (3) in the table below, the DC motor will trip and voltage output will stop approximately 1 minute after operation is started. For this reason, to measure the voltage again, turn OFF the unit once using the remote controller, and then start the air conditioner again.

[**Trouble symptom 1**] The fan does not stop when the unit stops. → Indoor unit controller trouble.

[**Trouble symptom 2**] The fan motor does not rotate when the unit is operating.

(Diagnostic procedure)

* Disconnect the motor connectors and measure the voltage at the DC motor connectors on the indoor unit controller (3 locations).

Measurement location	Normal value
(1) Vm-Gnd: Between pin 1 and pin 3	DC 230 V or more
(2) Vcc-Gnd: Between pin 4 and pin 3	DC 14 V or more
(3) Vs-Gnd: Between pin 5 and pin 3	Fluctuation between DC 1.7 to 6.1 V

(Diagnostic results)

All of the above measured values are normal. → Fan motor trouble (Replace the motor.)

Any one of the above measured values is not normal. → Indoor unit controller trouble (Replace the controller .)

(Reference) DC motor connector pin arrangement

- Pin 1: Vm (red)
- Pin 2: Not used
- Pin 3: Gnd (black)
- Pin 4: Vcc (white)
- Pin 5: Vs (yellow)
- Pin 6: PG (blue)

[**Trouble symptom 3**] Motor rotates for some time (several seconds), but then quickly stops, when the indoor unit operates.

(There is trouble in the system that provides feedback of motor rotation speed from the motor to the indoor unit controller.)

[**Trouble symptom 4**] Fan motor rotation speed does not change during indoor unit operation.

[**Trouble symptom 5**] Fan motor rotation speed varies excessively during indoor unit operation.

(Remedy for symptom 3 to 5)

It is not possible to identify whether the trouble is indoor unit controller trouble or motor trouble. Therefore, first replace the indoor unit controller, then (if necessary) replace the DC motor.

9-4-2. Outdoor Fan Motor

- This outdoor DC fan motor contains an internal control PCB. Therefore, it is not possible to measure the coil resistance, and the following procedure should be used to check the motor.
- Perform the trouble diagnosis by Test Run mode described on Installation Instructions.

Important: (A) Turn OFF the power before connecting or disconnecting the motor connectors.

(B) When performing voltage measurement at the outdoor controller connector for (3) in the table below, the DC motor will trip and voltage output will stop approximately 10 seconds after operation is started. For this reason, to measure the voltage again, first turn OFF the outdoor unit power, then, measure the voltage in Test Run mode.

[Trouble symptom 1] The fan does not stop when the outdoor unit stops. → Outdoor unit controller trouble

[Trouble symptom 2] The fan motor does not rotate when the outdoor unit is operating.

(Diagnostic procedure)

* Disconnect the motor connectors and measure the voltage at the DC motor connectors on the outdoor unit controller (3 locations).

Measurement location	Normal value
(1) Vs-Gnd : Between pin 1 and pin 4 or Vm-Gnd : Between pin 1 and pin 4	DC 230V or more
(2) Vcc-Gnd : Between pin 5 and pin 4	DC 14V or more
(3) Vsp-Gnd : Between pin 7 and pin 4	After fluctuating 4 times between DC 1.7 to 6.1V (1 sec. ON) and DC 0 V (1 sec. OFF), the DC motor trips.

(Diagnostic results)

All of the above measured values are normal. → Fan motor trouble (Replace the motor.)

Any one of the above measured values is not normal. → Outdoor unit controller trouble
(Replace the controller .)

(Reference) DC motor connector pin arrangement

CU-KS18NKU / CU-KS18NKUA	CU-KS24NKU / CU-KS24NKUA
Pin 1: Vs (white)	Pin 1: Vm (red)
Pin 2: Not used	Pin 2: Not used
Pin 3: Not used	Pin 3: Not used
Pin 4: Gnd (black)	Pin 4: Gnd (blue)
Pin 5: Vcc (red)	Pin 5: Vcc (brown)
Pin 6: FG (blue)	Pin 6: PG (white)
Pin 7: Vsp (yellow)	Pin 7: Vsp (orange)

[Trouble symptom 3] Motor rotates for some time (several seconds), but then quickly stops, when the outdoor unit operates.

(There is trouble in the system that provides feedback of motor rotation speed from the motor to the outdoor unit controller.)

[Trouble symptom 4] Fan motor rotation speed does not change during outdoor unit operation.

[Trouble symptom 5] Fan motor rotation speed varies excessively during outdoor unit operation.

(Remedy for symptom 3 to 5)

It is not possible to identify whether the trouble is outdoor unit controller trouble or motor trouble.

Therefore, first replace the outdoor unit controller, then (if necessary) replace the DC motor.

9-5. Noise Malfunction and Electromagnetic Interference

An inverter A/C operates using pulse signal control and high frequencies. Therefore, it is susceptible to the effects of external noise, and is likely to cause electromagnetic interference with nearby wireless devices.

A noise filter is installed for ordinary use, preventing these problems. However, depending on the installation conditions, these effects may still occur. Please pay attention to the points listed below.

(1) Noise malfunction

This refers to the application of high-frequency noise to the signal wires, resulting in abnormal signal pulses and malfunction.

Locations most susceptible to noise	Trouble	Correction
<ol style="list-style-type: none"> Locations near broadcast stations where there are strong electromagnetic waves Locations near amateur radio (short wave) stations Locations near electronic sewing machines and arc-welding machines 	<p>Either of the following trouble may occur.</p> <ol style="list-style-type: none"> The unit may stop suddenly during operation. Indicator lamps may flicker. 	<p>(The fundamental concept is to make the system less susceptible to noise.)</p> <p>- Insulate for noise or distance from the noise source. -</p> <ol style="list-style-type: none"> Use shielded wires. Move unit away from the noise source.

(2) Electromagnetic interference

This refers to noise generated by high-speed switching of the microcomputer and compressor. This noise radiates through space and returns to the electric wiring, affecting any wireless devices (televisions, radios, etc.) located nearby.

Locations most susceptible to noise	Trouble	Correction
<ol style="list-style-type: none"> A television or radio is located near the A/C and A/C wiring. The antenna cable for a television or radio is located close to the A/C and A/C wiring. Locations where television and radio signals are weak. 	<ol style="list-style-type: none"> Noise appears in the television picture, or the picture is distorted. Static occurs in the radio sound. 	<ol style="list-style-type: none"> Select a separate power source. Keep the A/C and A/C wiring at least 1 meter away from wireless devices and antenna cables. Change the wireless device's antenna to a high-sensitivity antenna. Change the antenna cable to a BS coaxial cable. Use a noise filter (for the wireless device). Use a signal booster.

10. CHECKING ELECTRICAL COMPONENTS

10-1. Measurement of Insulation Resistance

- The insulation is in good condition if the resistance exceeds 1M ohm.

10-1-1. Power Supply Cord

Clamp the grounding wire of power cord with the lead clip of the insulation resistance tester and measure the resistance by placing a probe on either of the two power wires. (Fig. 1)

Then also measure the resistance between the grounding and other power terminals. (Fig. 1)

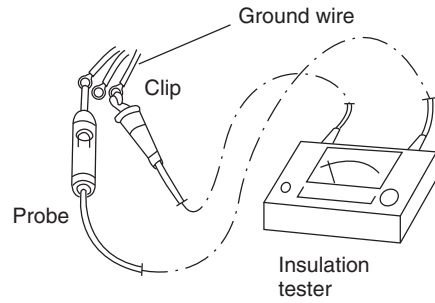

Fig. 1

10-1-2. Indoor Unit

Clamp an aluminum plate fin or copper tube with the lead clip of the insulation resistance tester and measure the resistance by placing a probe on each terminal screw on the terminal plate. (Fig. 2)

Note that the ground line terminal should be skipped for the check.

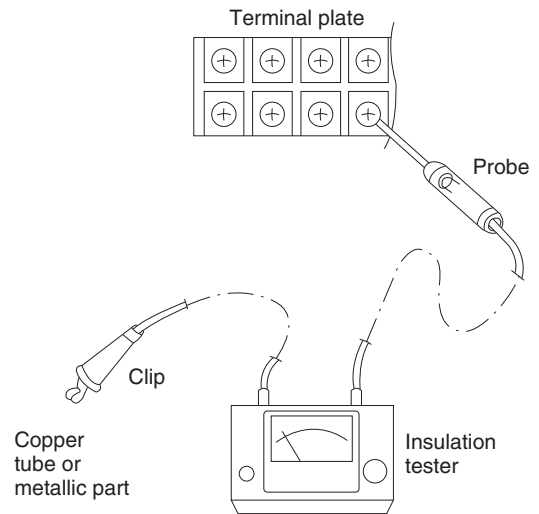

Fig. 2

10-1-3. Outdoor Unit

Clamp a metallic part of the unit with the lead clip of the insulation resistance tester and measure the resistance by placing a probe on each terminal screw where power supply lines are connected on the terminal plate. (Fig. 2)

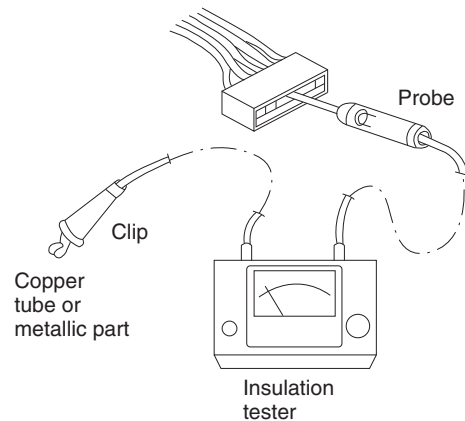

Fig. 3

10-1-4. Measurement of Insulation Resistance for Electrical Parts

Disconnect the lead wires of the desired electric part from terminal plate, capacitor, etc. Similarly disconnect the connector. Then measure the insulation resistance. (Figs. 3 and 4)

NOTE

Refer to Electric Wiring Diagram.

If the probe cannot enter the poles because the hole is too narrow then use a probe with a thinner pin.

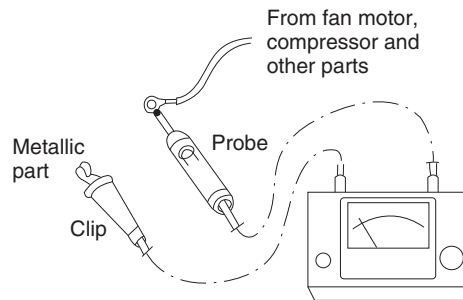

Fig. 4

10-2. Checking Continuity of Fuse on PCB Ass'y

- Remove the PCB Ass'y from the electrical component box. Then pull out the fuse from the PCB Ass'y. (Fig. 5)
- Check for continuity using a multimeter as shown in Fig. 6.

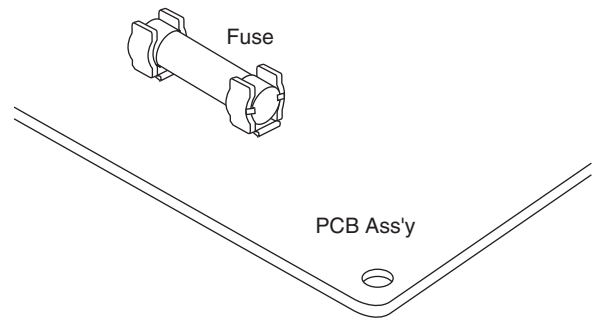

Fig. 5

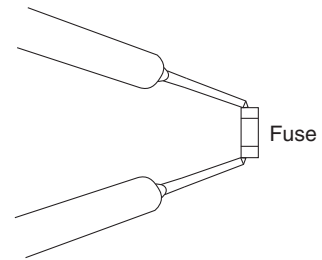

Fig. 6

11. REFRIGERANT R410A: SPECIAL PRECAUTIONS WHEN SERVICING UNIT

11-1. Characteristics of New Refrigerant R410A

11-1-1. What is New Refrigerant R410A?

R410A is a new refrigerant that contains two types of pseudo-non-azeotropic refrigerant mixture. Its refrigeration capacity and energy efficiency are about the same level as the conventional refrigerant, R22.

11-1-2. Components (mixing proportions)

HFC32 (50%) / HFC125 (50%)

11-1-3. Characteristics

- Less toxic, more chemically stable refrigerant
- The composition of refrigerant R410A changes whether it is in a gaseous phase or liquid phase. Thus, when there is a refrigerant leak the basic performance of the air conditioner may be degraded because of a change in composition of the remaining refrigerant. **Therefore, do not add new refrigerant.** Instead, recover the remaining refrigerant with the refrigerant recovery unit. Then, after evacuation, totally recharge the specified amount of refrigerant with the new refrigerant at its normal mixed composition state (in liquid phase).
- When refrigerant R410A is used, the composition will differ depending on whether it is in gaseous or liquid phase, and the basic performance of the air conditioner will be degraded if it is charged while the refrigerant is in gaseous state. **Thus, always charge the refrigerant while it is in liquid phase.**



CAUTION

Ether-type oil is used for compressor oil for R410A-type units, which is different from the mineral oil used for R22. Thus more attention to moisture prevention and faster replacement work compared with conventional models are required.

11-2. Checklist before Servicing

Use a clutch-type flare tool for R410A or the conventional flare tool. Note that sizes of the resultant flares differ between these two tools. Where a conventional flare tool is used, make sure to observe A Specification (amount of extrusion) by using the flare spacer.

Diameter of tube D	Specification A	
	Flare tool for R410A	Conventional flare tool (for R22)
Dia. 1/4" (6.35 mm)	0 to 0.0196" (0 to 0.5 mm)	0.0472" (1.2 mm)
Dia. 3/8" (9.52 mm)		
Dia. 1/2" (12.7 mm)		
Dia. 5/8" (15.88 mm)		

● Size of flare

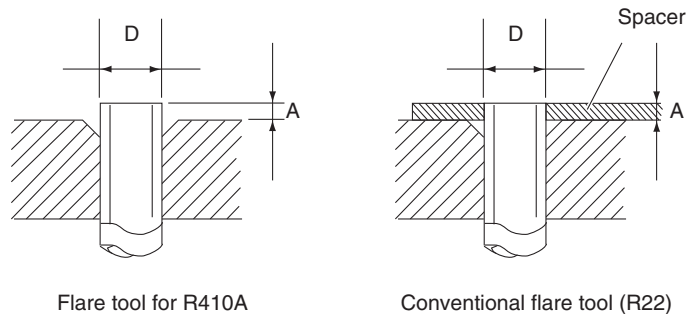

● Tubing precautions

- Refrigerant R410A is more easily affected by dust or moisture compared with R22, thus be sure to temporarily cover the ends of the tubing with caps or tape prior to installation.

Never use 0.0276" (0.7 mm)-thick copper tubing or tubing which is less than 0.0315" (0.8 mm) in thickness, since air conditioners with R410A are subject to higher pressure than those using R22 and R407C.

● No addition of compressor oil for R410A

No additional charge of compressor oil is permitted.

● No use of refrigerant other than R410A

Never use a refrigerant other than R410A.

● If refrigerant R410A is exposed to fire

Through welding, etc., toxic gas may be released when R410A refrigerant is exposed to fire. Therefore, be sure to provide ample ventilation during installation work.

● Caution in case of R410A leak

Check for possible leak points with the special leak detector for R410A. If a leak occurs inside the room, immediately provide thorough ventilation.

11-3. Tools Specifically for R410A

- For servicing, use the following tools for R410A

Tool Distinction	Tool Name
Tools specifically for R410A	<ul style="list-style-type: none"> ● Gauge manifold ● Charging hose ● Gas leak detector ● Refrigerant cylinder ● Charging cylinder ● Refrigerant recovery unit ● Vacuum pump with anti-reverse flow (*1) (Solenoid valve-installed type, which prevents oil from flowing back into the unit when the power is off, is recommended.) ● Vacuum pump (*2)...can be used if the following adapter is attached. ● Vacuum pump adapter (reverse-flow prevention adapter) (*3). (Solenoid valve-installed adapter attached to a conventional vacuum pump.) ● Electronic scale for charging refrigerant ● Flare tool
Tools which can be commonly used for R22, R407C, and R410A	<ul style="list-style-type: none"> ● Bender ● Torque wrench ● Cutter, reamer ● Welding tool, nitrogen gas cylinder



CAUTION

- The above tools specifically for R410A must not be used for R22 and R407C. Doing so will cause malfunction of the unit.
- For the above vacuum pump (*1, *2) and vacuum pump adapter (*3), those for R22-type units can be used for R410A-type. However, they must be used exclusively for R410A and never alternately with R22 and R407C.

- To prevent other refrigerants (R22, R407C) from being mistakenly charged to this unit, shape and external diameter of the service port screw has been altered.

<External diameter of service port> R410A : 5/16"
R22, R407C : 1/4"

11-4. Tubing Installation Procedures

When the tubes are connected, **always apply HAB oil on the flare portions to improve the sealing of tubing.**

The following is the **HAB oil** generally used:

Esso: ZERICE S32

NOTE For details on tubing installation procedures, refer to the installation manuals attached to the indoor unit and outdoor unit.

11-5. In Case of Compressor Malfunction



CAUTION

- Should the compressor malfunction, be sure to make the switch to a replacement compressor as quickly as possible.
- Use only the tools indicated exclusively for R410A. → See "11-3. Tools Specifically for R410A."

11-5-1. Procedure for Replacing Compressor

(1) Recovering refrigerant

- Any remaining refrigerant inside the unit should not be released to the atmosphere, but recovered using the refrigerant recovery unit for R410A.
- Do not reuse the recovered refrigerant, since it will contain impurities.

(2) Replacing Compressor

- Soon after removing seals of both discharge and suction tubes of the new compressor, replace it quickly.

(3) Checking for sealing

- Use nitrogen gas for the pressurized gas, and never use a refrigerant other than R410A. Also do not use oxygen or any flammable gas.

(4) Evacuation

- **Use a solenoid valve-installed vacuum pump** so that even if power is cut off in the middle of evacuation of air due to a power interruption, the valve will prevent the pump oil from flowing back.
- The equipment may be damaged if moisture remains in the tubing, thus carry out the evacuation thoroughly.
- When using a vacuum pump with exhaust air volume more than 0.883 cu.ft./min. and ultimate vacuum pressure rate of 50 micron Hg.

Standard time for evacuation

Length of tubing	Less than 33 ft. (10 m)	More than 33 ft. (10 m)
Evacuation time	More than 10 minutes	More than 15 minutes

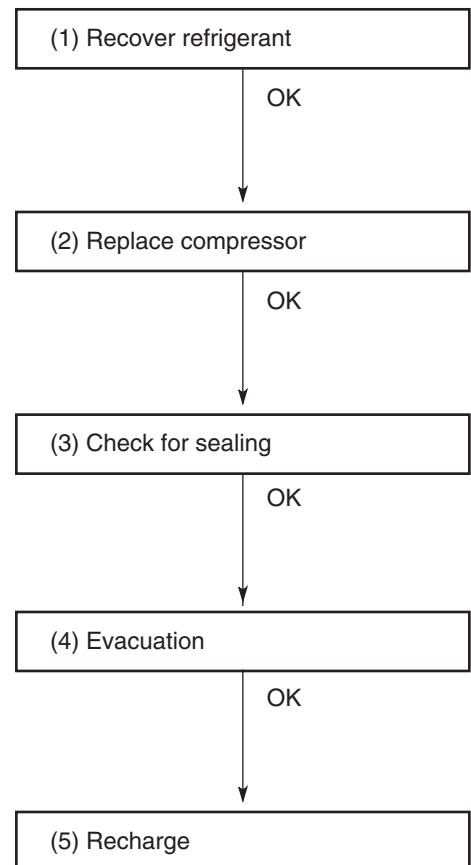

(5) Recharging

- **Be sure to charge the specified amount of refrigerant in liquid state** using the service port of the wide tube service valve. The proper amount is listed on the unit's nameplate.

When the entire amount cannot be charged all at once, charge gradually while operating the unit in Cooling Operation.



CAUTION

Never charge a large amount of liquid refrigerant at once to the unit. This may cause damage to the compressor.

- When charging with a refrigerant cylinder, use an electronic scale for charging refrigerant. In this case, if the volume of refrigerant in the cylinder becomes less than 20% of the fully-charged amount, the composition of the refrigerant starts to change. Thus, **do not use the refrigerant if the amount in the charging cylinder is less than 20%.**

Also, charge the minimum necessary amount to the charging cylinder before using it to charge the air conditioning unit.

Example:

In case of charging refrigerant to a unit requiring 1.68 lb. (0.76 Kg) using a capacity of a 22 lb. (10 Kg) cylinder, the minimum necessary amount for the cylinder is:

$$1.68 + 22 \times 0.20 = 6.08 \text{ lb.}$$

$$(0.76 + 10 \times 0.20 = 2.76 \text{ Kg})$$

- **For the remaining refrigerant, refer to the instructions of the refrigerant manufacturer.**

If using a charging cylinder, transfer the specified amount of liquid refrigerant from the refrigerant cylinder to the charging cylinder.

Prepare an evacuated charging cylinder beforehand.



CAUTION

- **To prevent the composition of R410A from changing, never bleed the refrigerant gas into the atmosphere while transferring the refrigerant. (Fig. 3)**

Do not use the refrigerant if the amount in the charging cylinder is less than 20%.

Configuration and characteristics of cylinders

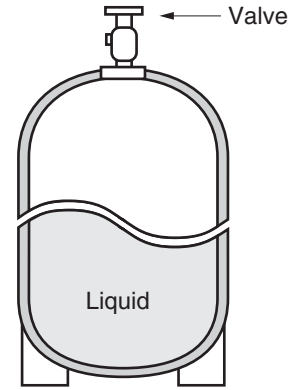

Single valve

Charge liquid refrigerant with cylinder in up-side-down position.

Fig. 1

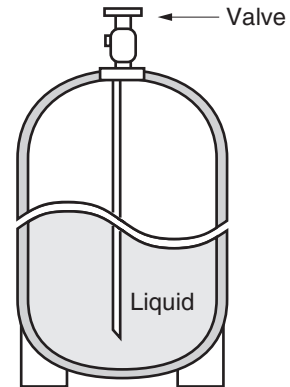

Single valve (with siphon tube)

Charge with cylinder in normal position.

Fig. 2

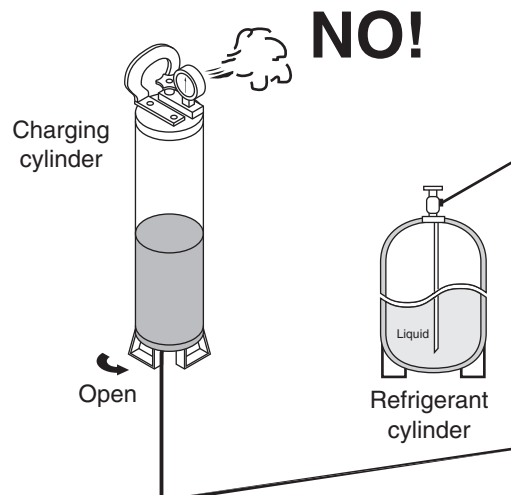

Fig. 3

11-6. In Case Refrigerant is Leaking



CAUTION

Never attempt to charge additional refrigerant when refrigerant has been leaking from the unit. Follow the procedure described below to locate points of leaks and carry out repairs, then recharge the refrigerant.

(1) Detecting Leaks

- Use the detector for R410A to locate refrigerant leak points.

(2) Recovering refrigerant

- Never release the gas to the atmosphere; recover residual refrigerant using the refrigerant recovery unit for R410A, instead.
- Do not reuse the recovered refrigerant because its composition will have been altered.

(3) Welding leaking points

- Confirm again that no residual refrigerant exists in the unit before starting welding.
- Weld securely using flux and wax for R410A.
- Prevent oxide film from forming inside the tubes utilizing substitution with nitrogen (N₂) in the refrigerant circuit of the unit. Leave ends of tubes open during welding.

(4) Checking for sealing

- Use nitrogen gas for the pressurized gas, and never use a refrigerant other than R410A. Also do not use oxygen or any flammable gas.

(5) Evacuation

- **Use a solenoid valve-installed vacuum pump** so that even if power is cut off in the middle of evacuation of air due to a power interruption, the valve will prevent the pump oil from flowing back.
- The equipment may be damaged if moisture remains in the tubing, thus carry out the evacuation thoroughly.
- When using a vacuum pump with exhaust air volume more than 0.883 cu.ft./min. and ultimate vacuum pressure rate of 50 micron Hg.

Standard time for evacuation

Length of tubing	Less than 33 ft. (10 m)	More than 33 ft. (10 m)
Evacuation time	More than 10 minutes	More than 15 minutes

(6) Recharging

- Recharge unit in the same manner explained on the previous page "(5) Recharging."

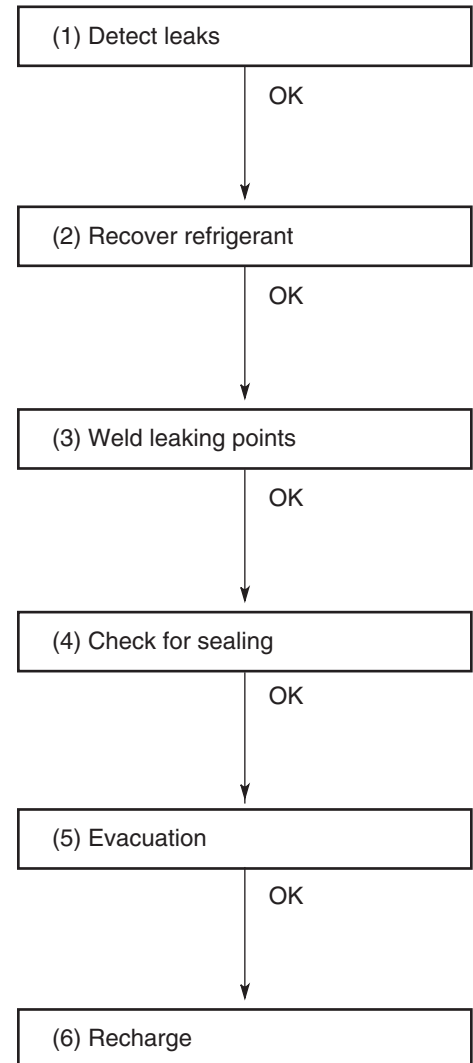

11-7. Charging Additional Refrigerant

11-7-1. When Tubes are Extended

- Observe the proper amount of refrigerant as stated in this service manual or the installation manual that came with the indoor unit. **Charge additional refrigerant in liquid state only.**



CAUTION

Never charge additional refrigerant if refrigerant is leaking from the unit. Follow instructions given in "11-6. In Case Refrigerant is Leaking" and completely carry out repairs. Only then should you recharge the refrigerant.

11-8. Retro-Fitting Existing Systems

11-8-1. Use of Existing Units

- **Never use new refrigerant R410A for existing units which use R22.** This will cause the air conditioner to operate improperly and may result in a hazardous condition.

11-8-2. Use of Existing Tubing

- If replacing an older unit that used refrigerant R22 with a R410A unit, **do not use its existing tubing.** Instead, completely new tubing must be used.

APPENDIX A Operating Instructions

**CS-KS18NKU + CU-KS18NKU
+ CU-KS18NKUA**

**CS-KS24NKU + CU-KS24NKU
+ CU-KS24NKUA**

(852-6-4181-210-00-1)

Panasonic[®]

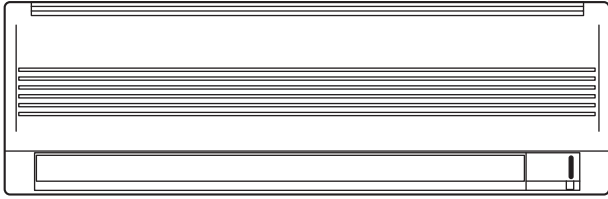

Operating Instructions Split System Air Conditioner

Model No.

Indoor Units

CS-KS18NKU

CS-KS24NKU

Outdoor Units

CU-KS18NKU

CU-KS18NKUA

CU-KS24NKU

CU-KS24NKUA

This air conditioner uses the refrigerant R410A.



Before operating the unit, read these operating instructions thoroughly and keep them for future reference.

Panasonic Corporation
1006 Kadoma, Kadoma City, Osaka, Japan

FEATURES

This air conditioner is an inverter type unit that automatically adjusts capability as appropriate. Details on these functions are provided below; refer to these descriptions when using the air conditioner.

- **Microprocessor Controlled Operation**
The interior compartment of the remote controller contains several features to facilitate automatic operation, easy logically displayed for easy use.
- **Simple One-touch Remote Controller**
The remote controller has several features to facilitate automatic operation.
- **24-Hour ON or OFF Timer**
This timer can be set to automatically turn the unit on or off at any time within a 24 hour period.
- **1-Hour OFF Timer**
This timer can be set to automatically turn off the unit at any time after one hour.
- **Night Setback**
This function saves energy by controlling operation to provide a quieter operating sound than normal.
- **Automatic and 3-step Fan Speed**
Auto/High/Medium/Low
- **Air Sweep Control**
This function moves a flap up and down in the air outlet, directing air in a sweeping motion around the room and providing comfort in every corner.
- **Auto. Flap Control**
This automatically sets the flap to the optimum position during heating, cooling, and drying operation.
- **Automatic Restart Function for Power Failure**
Even when power failure occurs, preset programmed operation can be reactivated once power resumes.
- **High Power Operation**
The unit operates at maximum output for 30 minutes, regardless of the desired temperature. The fan speed is 1 step above "High".
- **Quiet Operation**
The fan rotates slower than the fan speed setting to provide a quieter operating sound.

CONTENTS

	Page		Page
FEATURES.....	2	SPECIAL REMARKS	16
PRODUCT INFORMATION	2	SETTING THE TIMER	17
SAFETY PRECAUTIONS.....	2	USING THE 1-HOUR OFF TIMER.....	19
INSTALLATION LOCATION.....	3	TIPS FOR ENERGY SAVING	19
ELECTRICAL REQUIREMENTS	3	ADJUSTING THE AIRFLOW DIRECTION.....	20
SAFETY INSTRUCTIONS.....	3	OPERATION WITHOUT THE REMOTE CONTROLLER.....	21
NAMES OF PARTS	5	CARE AND CLEANING	21
USING THE REMOTE CONTROLLER	10	WIRED REMOTE CONTROLLER.....	23
OPERATION WITH THE REMOTE CONTROLLER	12	TROUBLESHOOTING (BEFORE CALLING FOR SERVICE)	24
1. Operation	12	OPERATING RANGE.....	24
2. Adjusting the Fan Speed.....	13	SPECIFICATIONS.....	25
3. Fan Only.....	13		
4. Night Setback Mode.....	14		
5. QUIET Mode	15		
6. HIGH POWER Mode.....	15		

PRODUCT INFORMATION

If you have problems or questions concerning your Air Conditioner, you will need the following information. Model and serial numbers are on the nameplate on the bottom of the cabinet.

Model No. _____

Serial No. _____

Date of purchase _____

Dealer's address _____

Phone number _____

SAFETY PRECAUTIONS

The following symbols used in this manual, alert you to potentially dangerous conditions to users, service personnel or the appliance:



WARNING

This symbol refers to a hazard or unsafe practice which can result in severe personal injury or death.



CAUTION

This symbol refers to a hazard or unsafe practice which can result in personal injury or product or property damage.

INSTALLATION LOCATION

- We recommend that this air conditioner be installed properly by qualified installation technicians in accordance with the Installation Instructions provided with the unit.
- Before installation, check that the voltage of the electric supply in your home or office is the same as the voltage shown on the nameplate.



WARNING

- Do not install this air conditioner where there are fumes or flammable gases, or in an extremely humid space such as a greenhouse.
- Do not install the air conditioner where excessively high heat-generating objects are placed.

EG

Avoid: To protect the air conditioner from heavy corrosion, avoid installing the outdoor unit where salty sea water can splash directly onto it or in sulphurous air near a spa.

ELECTRICAL REQUIREMENTS

1. All wiring must conform to the local electrical codes. Consult your dealer or a qualified electrician for details.
2. Each unit must be properly grounded with a ground (or earth) wire or through the supply wiring.
3. Wiring must be done by a qualified electrician.

NOTE

Pull off the power plug from a receptacle, or switch off the breaker, or switch off the power disconnecting mean to isolate the air conditioner from the main power supply when not in use for a long time.

SAFETY INSTRUCTIONS

- Read this Instruction Manual carefully before using this air conditioner. If you still have any difficulties or problems, consult your dealer for help.
- This air conditioner is designed to give you comfortable room conditions. Use this only for its intended purpose as described in this Instruction Manual.





WARNING

- Confirm to authorized dealer or specialist on usage of specified refrigerant type. Using of refrigerant other than the specified type may cause product damage, burst and injury etc.
- Never touch the unit with wet hands.
- Never use or store gasoline or other flammable vapor or liquid near the air conditioner — it is very dangerous.
- Do not use this appliance in a potentially explosive atmosphere.
- This air conditioner has no ventilator for intaking fresh air from outdoors. You must open doors or windows frequently when you use gas or oil heating appliances in the same room, which consume a lot of oxygen from the air. Otherwise there is a risk of suffocation in an extreme case.
- Do not swallow the battery.
- After removing the battery from remote controller, keep it away from the reach of children. The battery can cause death by suffocation if swallowed.
- When inserting the battery, make sure the polarities (+ and -) are correct.







WARNING

- To prevent possible hazards from insulation failure, the unit must be grounded. 
- Do not clean inside the indoor and outdoor units by users. Engage authorized dealer or specialist for cleaning.
- In case of malfunction of this appliance, do not repair by yourself. Contact to the sales dealer or service dealer for a repair.
- Refrigerant gas leakage may cause fire.
- For safety, be sure to turn the air conditioner off and also to disconnect the power before cleaning. 
- Pull off the power plug from a receptacle, or switch off the breaker, or switch off the power disconnecting mean to isolate the air conditioner from the main power supply in case of emergency.



CAUTION

- Do not turn the air conditioner on and off from the power mains switch. Use the ON/OFF operation button.
- Do not stick anything into the air outlet of the outdoor unit. This is dangerous because the fan is rotating at high speed. 
- Do not touch the air inlet or the sharp aluminum fins of the outdoor unit. You may get injured. 
- Keep the fire alarm and the air outlet at least 1.5m away from the unit.
- Do not let children play with the air conditioner.
- Do not cool or heat the room too much if babies or invalids are present.
- Do not sit or step on the unit. You may fall down accidentally. 
- Do not stick any object into the FAN CASE. You may be injured and the unit may be damaged. 

NOTICE

- **This device complies with part 15 of the FCC Rules.**
Operation is subject to the following two conditions:
(1) This device may not cause harmful interference, and (2) this device must accept any interference received, including interference that may cause undesired operation.
- **This equipment has been tested and found to comply with the limits for a Class B digital device, pursuant to part 15 of the FCC Rules.**
These limits are designed to provide reasonable protection against harmful interference in a residential installation. This equipment generates, uses and can radiate radio frequency energy and, if not installed and used in accordance with the instructions, may cause harmful interference to radio communications. However, there is no guarantee that interference will not occur in a particular installation. If this equipment does cause harmful interference to radio or television reception, which can be determined by turning the equipment off and on, the user is encouraged to try to correct the interference by one or more of the following measures:
 - Reorient or relocate the receiving antenna.
 - Increase the separation between the equipment and receiver.
 - Connect the equipment into an outlet on a circuit different from that to which the receiver is connected.
 - Consult the dealer or an experienced radio/TV technician for help.
- FCC Caution: To assure continued compliance, follow the attached installation instructions. Any changes or modifications not expressly approved by the party responsible for compliance could void the user's authority to operate this equipment.

NAMES OF PARTS

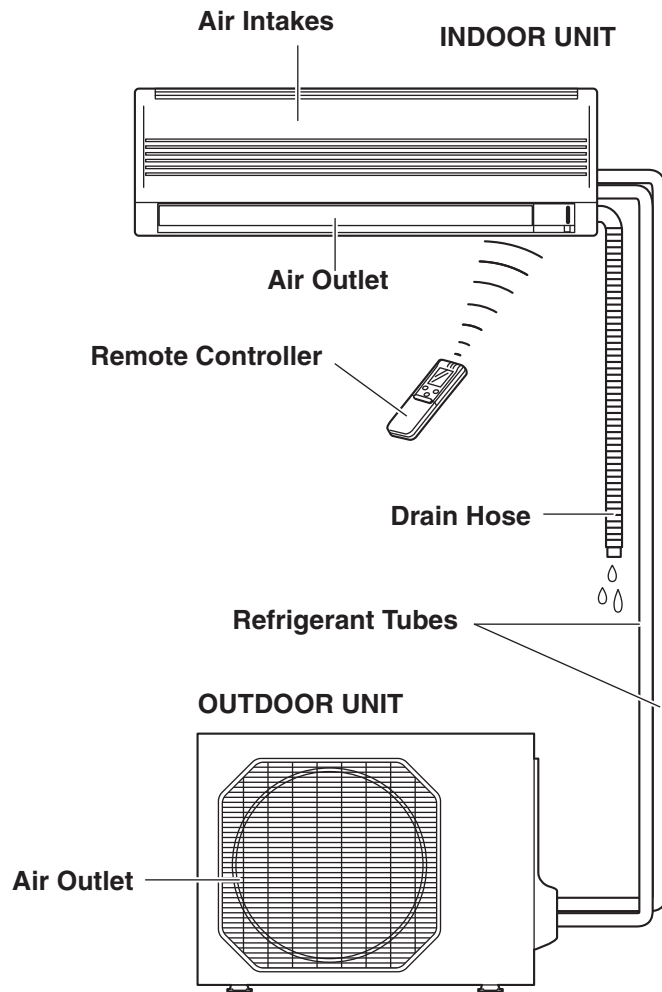

EG

NOTE

This illustration is based on the external view of a standard model. Consequently, the shape may differ from that of the air conditioner which you have selected.

This air conditioner consists of an indoor unit and an outdoor unit. You can control the air conditioner with the remote controller.

Air Intake	Air from the room is drawn into this section and passes through air filters which remove dust.
Air Outlet	Conditioned air is blown out of the air conditioner through the air outlet.
Remote Controller	The remote controller controls power ON/OFF, operation mode selection, temperature, fan speed, timer setting, and air sweeping.
Refrigerant Tubes	The indoor and outdoor units are connected by copper tubes through which refrigerant gas flows.
Drain Hose	Moisture in the room condenses and drains off through this hose.
Outdoor (Condensing) Unit	The outdoor unit contains the compressor, fan motor, heat exchanger coil, and other electrical components.

UNIT DISPLAY AND OPERATION BUTTON



IMPORTANT

Avoid using radio equipment such as mobile phone near (within 4 ft (1.2m).) the remote control receiver. Some radio equipment may cause malfunction of the unit.

If the trouble happens, disconnect power and restart the air conditioner after a few minutes.

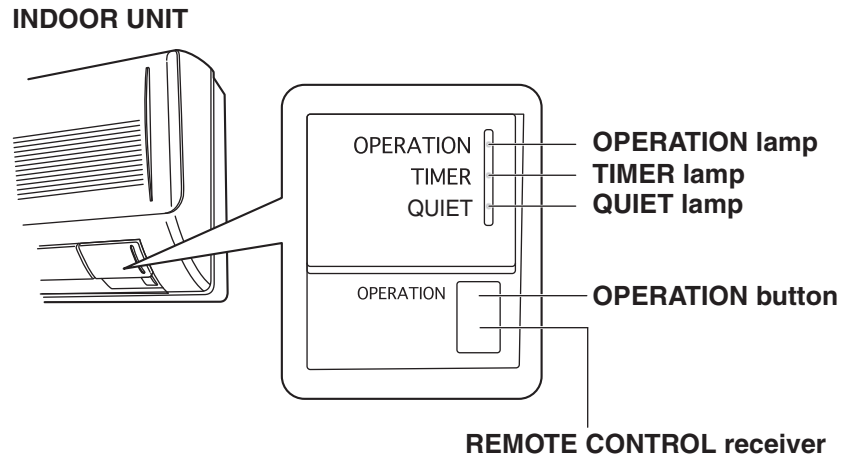

REMOTE CONTROL receiver	This section picks up infrared signals from the remote controller (transmitter).
OPERATION button	<p>When the remote controller cannot be used, pressing this button enables cooling operation.</p> <p>Each time this button is pressed, the operation mode changes cyclically.</p> <div style="text-align: center;"> <p>Cooling operation \longrightarrow Stop</p> </div>
OPERATION lamp	This lamp lights when the system is in the continuous DRY (orange), COOL (green) and FAN (green) mode.
TIMER lamp	This lamp lights when the system is being controlled by the timer.
QUIET lamp	This lamp lights during operation in the QUIET mode.

NOTE

The unit's display lamps are dimmed during operation in the NIGHT SETBACK mode.

REMOTE CONTROLLER (DISPLAY)

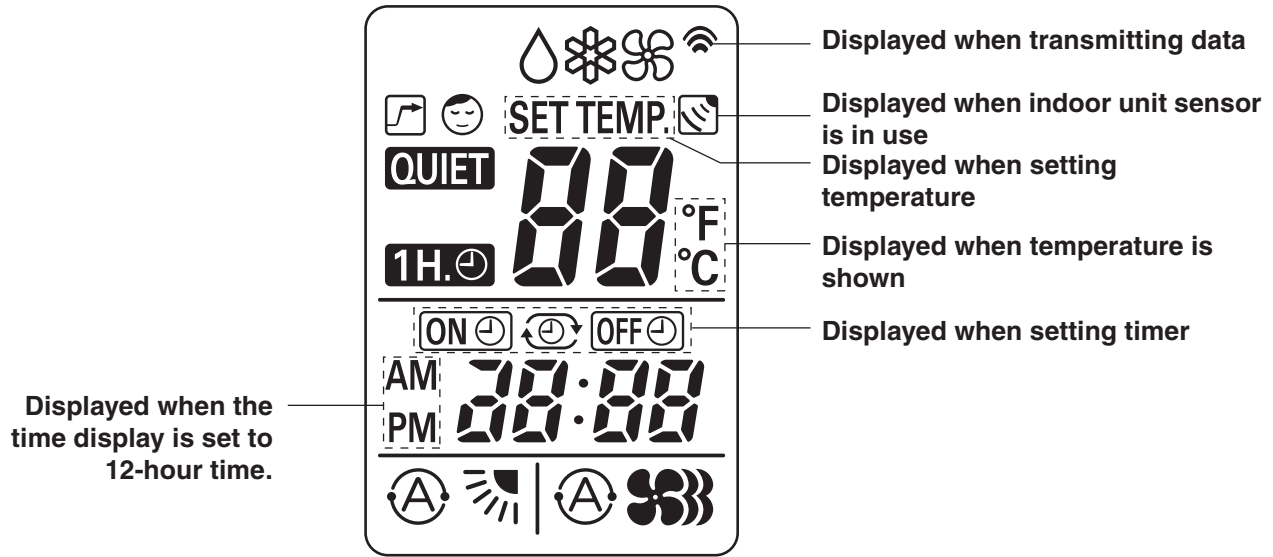

EG

Symbols

(1) Operation mode

MILD DRY



COOL



FAN



(2) Fan speed

Automatic operation



HIGH



MEDIUM



LOW



(3) Temperature setting

60 – 86 °F
When set to 80 °F
temperature indication

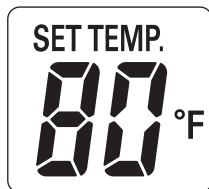

(4) Timer

24-hour clock with ON/OFF
program Timer



ON Timer



OFF Timer



1-hour OFF Timer



(5) NIGHT SETBACK



(6) Confirmation of transmission



(7) Auto. fla.dication



Flap angle indication



Sweep indication



(8) High power operation



(9) Quiet operation





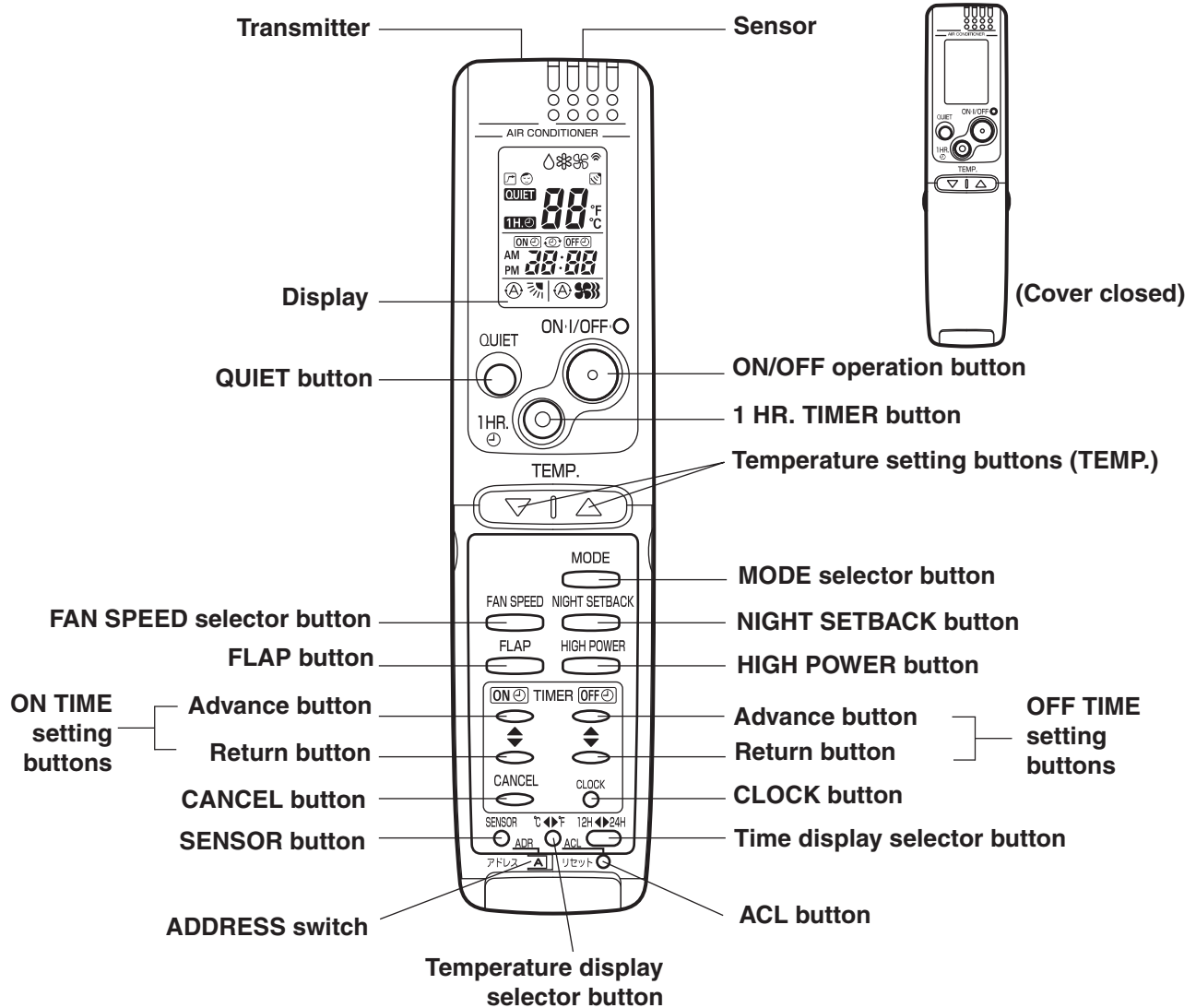

















REMOTE CONTROLLER

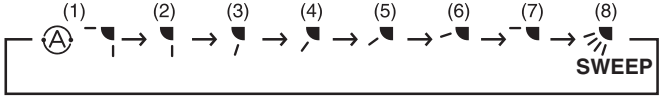

NOTE The illustration above pictures the remote controller after the cover has been opened.

Transmitter	When you press the buttons on the remote controller, the  mark appears in the display to transmit the setting changes to the receiver in the air conditioner.
Sensor	A temperature sensor inside the remote controller senses the room temperature.
Display	Information on the operating conditions is displayed while the remote controller is switched on. If the unit is turned off, FLAP setting and FAN SPEED setting are not displayed.
QUIET button	QUIET : When you press this button, the fan rotates slower than the fan speed setting to provide a quieter operating sound.
ON/OFF operation button	This button is for turning the air conditioner on and off.
1 HR. TIMER button (1-HOUR OFF TIMER)	1H.⏰ : When you press this button, regardless of whether the unit is operating or stopping, the unit operates for one hour and then shuts down.

REMOTE CONTROLLER (CONTINUED)

<p>Temperature setting buttons (TEMP.)</p>	<p>Press the  button to increase the set temperature. Press the  button to reduce the set temperature. The temperature setting changes by 1 °C or 2 °F each time one of the TEMP. buttons is pressed.</p>
<p>MODE selector button (DRY) (COOL) (FAN)</p>	<p>Use this button to select DRY, COOL or FAN mode.</p> <p> : The air conditioner reduces the humidity in the room.  : The air conditioner makes the room cooler.  : The air conditioner works only as a circulation fan.</p>
<p>FAN SPEED selector button</p>	<p> : The air conditioner automatically decides the fan speeds.  : High fan speed  : Medium fan speed  : Low fan speed</p>
<p>NIGHT SETBACK button</p>	<p>For details, see “4. Night Setback Mode”. When you press this button in the DRY or COOL mode, the  mark appears in the display, and the remote controller will automatically adjust the set temperature to save energy.</p>
<p>FLAP button</p> <p style="text-align: right;">NOTE</p>	<p>Press this button either to select the setting of the airflow direction to the auto. flap in each mode or one of the six possible positions manually or to select the sweep function which moves the flap up and down automatically.</p> <p> : Auto flap setting: If selected in a cooling or dry operation, the flap is set at position (7) in the following chart.  : The airflow direction can be set manually. (six positions)  : The flap moves up and down automatically.</p> <p>When you press the FLAP button, the air flow direction will be changed one by one as follows.</p> <div style="text-align: center;">  </div>
<p>HIGH POWER button</p>	<p> : If this button is pressed during DRY, COOL or FAN operation, the unit operates at maximum output for 30 minutes, regardless of the desired temperature. The fan speed is 1 step above “High”.</p>
<p>ON TIME/OFF TIME setting buttons</p>	<p>No display: The timer does not operate.  : The air conditioner starts at the set time.  : The air conditioner stops at the set time.    : The air conditioner stops and starts, or starts and stops, at the set times every day. For details, see “SETTING THE TIMER”.</p>
<p>SENSOR button</p> <p style="text-align: right;">NOTE</p>	<p>When you press this button (use a small-tipped object such as a ballpoint pen), the  mark will appear at the display. And the room temperature is detected by the sensor which is built into the indoor unit and the air conditioner is controlled accordingly.</p> <p>If the remote controller is located near a heat source, such as a space heater or in direct sunlight, press the SENSOR button to switch to the sensor on the indoor unit.</p>

EG

NOTE The indoor fan runs continuously when the system is in normal operation. It does not turn off when the desired room temperature is reached. If Night Set Back mode is selected, the fan will turn off intermittently during cooling operation in order to control air flow.

REMOTE CONTROLLER (CONTINUED)

Temperature Display Selector button	This switches the temperature display between °C and °F.
Time Display Selector button	This switches the time display between 24-hour time and 12-hour time.
ACL button (ALL CLEAR)	Puts the remote controller into pre-operation status. Always press this button after replacing the batteries.
ADDRESS switch	<ul style="list-style-type: none"> The address switch changes to prevent mixing of signals from remote controller's when two air conditioners are installed next to each other. Normally, the address switch is set to A. For more information, please contact the dealer where you made the purchase. Normally, the tabs on the remote controller should not be bent.

NOTE The remote controller sends the temperature signal to the air conditioner regularly at five minute intervals. If the signal from the remote controller stops for more than 15 minutes due to the loss of the remote controller or other trouble, the air conditioner will switch to the temperature sensor which is built into the indoor unit and control the room temperature. In these cases, the temperature around the remote controller may differ from the temperature detected at the air conditioner's position.

USING THE REMOTE CONTROLLER

How to Install Batteries

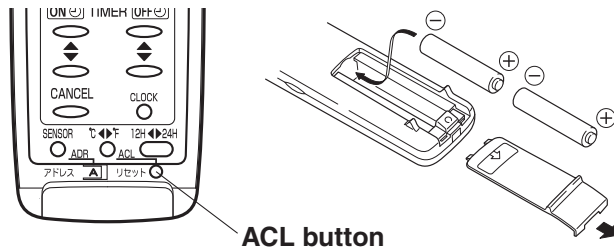

1. Slide the cover in the direction indicated by the arrow and remove it.
2. Install two AAA alkaline batteries. Make sure the batteries point in the direction marked in the battery compartment.
3. Use a thin object such as the tip of a pen to press the ACL button.



CAUTION

- The batteries last about six months, depending on how much you use the remote controller. Replace the batteries when the remote controller's display fails to light, or when the remote controller cannot be used to change the air conditioner's settings.
- Use two fresh leak-proof type-AAA alkaline batteries.
- In replacing batteries, follow the instructions as mentioned in the subsection "How to Install Batteries".
- If you do not use the remote controller more than 1 month, take out the batteries.
- Dispose of the used batteries at the designated location in compliance with the applicable local ordinances.

Information for Users on Collection and Disposal of Old Equipment and used Batteries



[Information on Disposal in other Countries outside the European Union]
These symbols are only valid in the European Union. If you wish to discard these items, please contact your local authorities or dealer and ask for the correct method of disposal.



Pb

Note for the battery symbol (bottom two symbol examples):

This symbol might be used in combination with a chemical symbol. In this case it complies with the requirement set by the Directive for the chemical involved.

USING THE REMOTE CONTROLLER (CONTINUED)

How to Use the Remote Controller

When using the remote controller, always point the unit's transmitter head directly at the air conditioner's receiver.

Air Conditioner (Indoor unit)

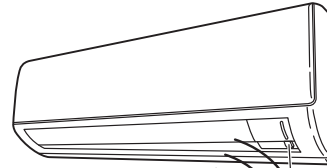

Remote Controller



EG

Remote Controller Installation Position

The remote controller may be operated either from a non-fixed position or from a wall-mounted position. To ensure that the air conditioner operates correctly, do not install the remote controller in the following places:

- In direct sunlight
- Behind a curtain or other places where it is covered
- More than 26 ft (8 m) away from the air conditioner
- In the path of the air conditioner's airstream
- Where it may become extremely hot or cold
- Where it may be subject to electrical or magnetic noise
- Where there is an obstacle between the remote controller and air conditioner (since a check signal is sent from the remote controller every 5 minutes)

Mounting the Remote Controller

Before mounting the remote controller, press the ON/OFF operation button at the mounting location to make sure that the air conditioner operates from that location. The indoor unit should make a beeping sound to indicate that it has received the signal.

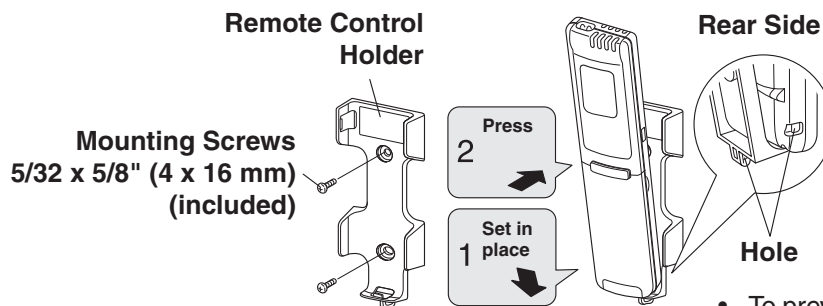

- To prevent loss of the remote controller, you can connect the remote controller to the holder by passing a string through the remote controller and attachment hole.

To take out the remote controller, pull it forward.

When Holding the Remote Controller

- When using the remote controller and during air conditioner operation, the transmitter on the remote controller should be pointed towards the receiver on the indoor unit.
- Make sure that there are no objects between the remote controller and receiver which could block the signal.

OPERATION WITH THE REMOTE CONTROLLER

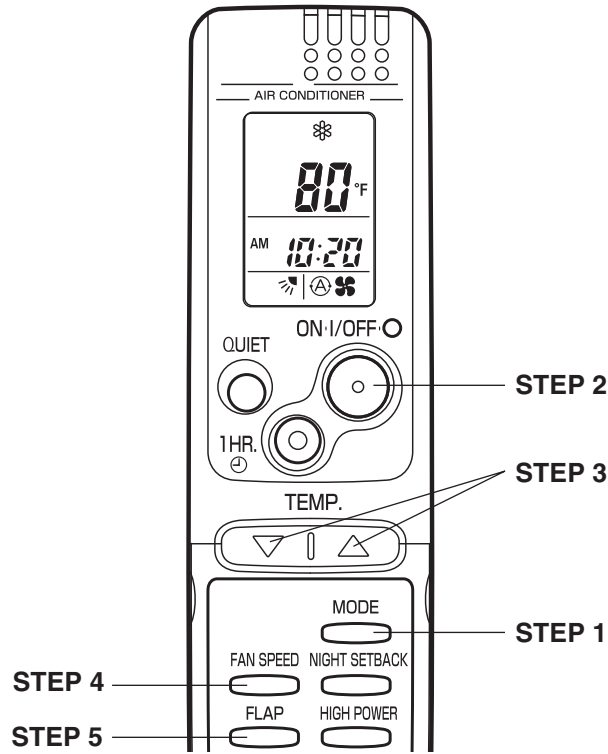

1. Operation



NOTE

Check that the circuit breaker on the power panel is turned on.

Press the setting buttons as described below and change the settings as desired.

STEP 1	Press the MODE selector button and select the desired mode. For dehumidifying operation →  For cooling operation →  For fan only operation → 
STEP 2	To start the air conditioner, press the ON/OFF operation button.
STEP 3	Press the TEMP. setting buttons to change the temperature setting to the desired temperature. Adjustable temperature range: <div style="text-align: center;"> 30 °C max. or 86 °F max. 16 °C min. 60 °F min. </div>
STEP 4	Set the FAN SPEED selector button to the setting you want.
STEP 5	Press the FLAP button and set the airflow direction as desired. (Refer to “ADJUSTING THE AIRFLOW DIRECTION” on page 20.)

To stop the air conditioner, press the ON/OFF operation button again.

OPERATION WITH THE REMOTE CONTROLLER (CONTINUED)

NOTE

- Choose the best position in the room for the remote controller, which also acts as the sensor for room comfort and transmits the operating instructions. Once you've found this best position, always keep the remote controller there.
- This appliance has a built-in 5-minute time delay circuit to ensure reliable operation. When the operation button is pressed, the compressor will start running within three minutes. In the event of power failure, the unit will stop.



EG

2. Adjusting the Fan Speed

A. Automatic fan speed

Simply set the FAN SPEED selector button to the  position. This automatically sets the best fan speed for the room temperature.



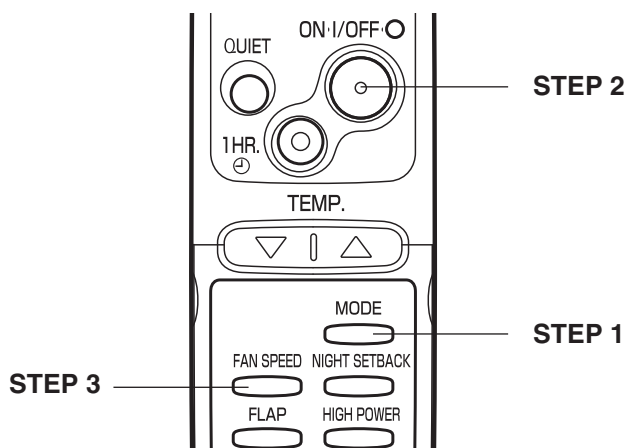

B. Manual fan speed

If you want to adjust fan speed manually during operation, just set the FAN SPEED selector button as desired. [, , or ]

3. Fan Only



If you want to circulate air without any temperature control, follow these steps:

STEP 1	Press the MODE selector button to switch to the fan mode  .
STEP 2	Press the ON/OFF operation button.
STEP 3	Press the FAN SPEED selector button to select the fan speed of your choice ( ,  , or ).

OPERATION WITH THE REMOTE CONTROLLER (CONTINUED)

4. Night Setback Mode

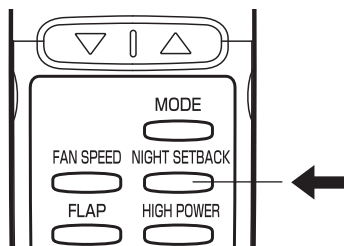
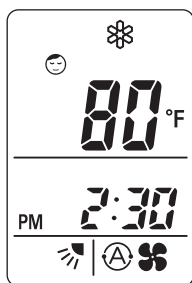

In Cooling and DRY Mode: (❄️ and 💧)

Night Setback Mode is used for saving energy.

Press the NIGHT SETBACK button while unit is operating. (except FAN mode)
The 😊 mark appears in the display.

To release the night setback function, press the NIGHT SETBACK button again.

NOTE

Pressing the MODE selector button cancels Night Setback mode.

When the night setback mode is selected, the air conditioner automatically raises the temperature setting 2 °F when 30 minutes have passed after the selection was made, and then another 2 °F after another 30 minutes have passed, regardless of the indoor temperature when night setback was selected. This enables you to save energy without sacrificing comfort. This function is convenient when gentle cooling is needed.

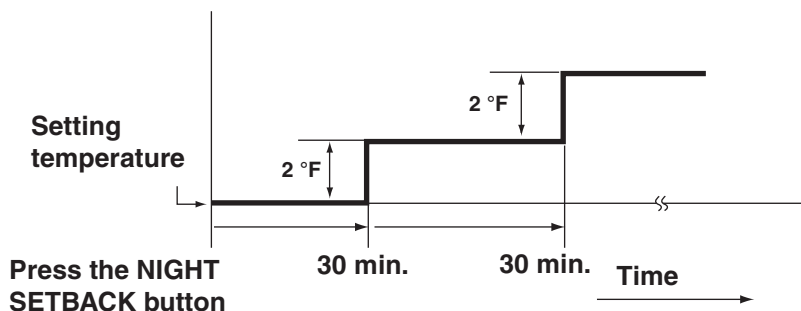

OPERATION WITH THE REMOTE CONTROLLER (CONTINUED)

5. QUIET Mode

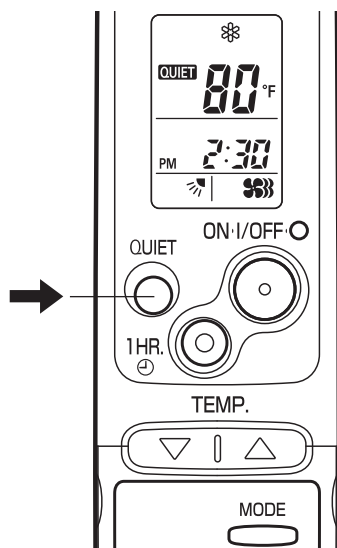

QUIET Mode is used to reduce the fan sound of the indoor unit.

Press the QUIET button.

The **QUIET** mark appears in the display.

To cancel, press QUIET button again.

- In QUIET Mode, the fan rotates at a slower speed than the fan speed setting.
- If the unit is already operating with a very low airflow, the fan sound may not change even if the QUIET button is pressed.

EG

6. HIGH POWER Mode

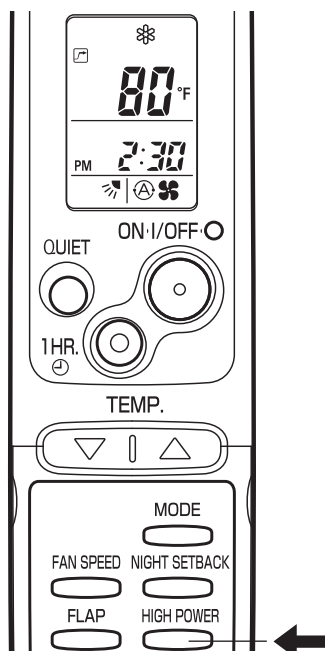

HIGH POWER mode can be used to increase the output of the indoor unit for all operation modes.

Press the HIGH POWER button while unit is operating.

The  mark appears in the display.

To cancel, press HIGH POWER button again.

- When the HIGH POWER button is pressed, the unit operates at maximum output for 30 minutes, regardless of the desired temperature. The fan speed is 1 step above “High”.
- QUIET Mode and HIGH POWER Mode cannot be used at the same time.

NOTE

- Pressing the MODE selector button cancels HIGH POWER mode.
- Depending on the operating conditions, the fan speed may be increased by a small amount only.

SPECIAL REMARKS

“DRY” (∪) Operation

How it works?

- Once the room temperature reaches the level that was set, the unit's operation frequency is changed automatically.
- During DRY operation, the fan speed automatically runs at lower speed for providing a comfortable breeze.
- “DRY” operation is not possible if the indoor temperature is 59 °F or less.

Cooling (*) Operation

- Sometimes the indoor unit may not get to the set fan speed such as LOW and QUIET under cool operation at very low outdoor temperatures due to the indoor unit being protected from ice or frost when combined with the outdoor unit for Low Ambient Cooling models.

Power failure during operation

- In the event of power failure, the unit will stop. When the power is resumed, the unit will restart automatically within five minutes by the remote controller.

Clicking Sound

Clicking sound is heard from the air conditioner

- In cooling operation, any plastic parts may shrink due to a sudden temperature change. In this event, a clicking sound may occur. This is normal, and the sound will soon disappear.

Remote Controller

- The remote controller sends the setting condition to the air conditioner regularly at five minute intervals.

SETTING THE TIMER

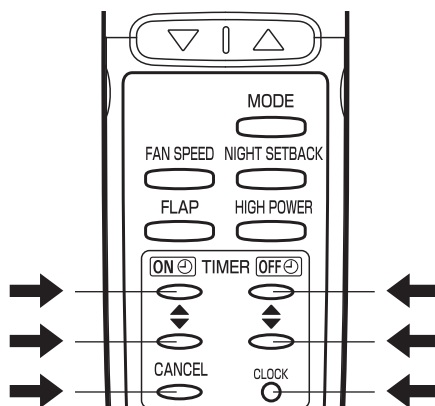

EG

NOTE

In the descriptions below, the following settings are used for the temperature and time indicator selector button on the bottom front section of the remote controller.

- Temperature: °F
- Time: AM, PM

1. How to set the present time

(Example) To set to 10:30 pm.

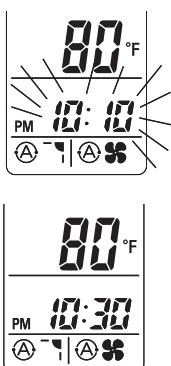

Operation	Indication
1. Press the CLOCK button once if the time indicator is not flashing.	The time indication alone flashes.
2. Press the Advance, Return (▲, ▼) button until PM 10:30 is displayed.	The time can be set in 1-minute increments. Holding down the button advances the time rapidly in 10-minute increments.
3. Press the CLOCK button again.	This completes the setting of the current time.

2. How to set the OFF time

(Example) To stop the air conditioner at 11:00 am.

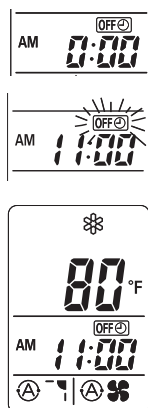

Operation	Indication
1. Press the OFF TIME setting button once.	The timer (OFF) indication is displayed, and the present OFF time is shown.
2. Press the Advance, Return (▲, ▼) button until AM 11:00 is displayed.	The timer (OFF) indication blinks. The time can be set in 10-minute increments. Holding down the button advances the time rapidly in 10-minute increments.
3. Wait a few seconds, and then the setting is complete.	The timer (OFF) indication stops blinking and the present time is displayed.

SETTING THE TIMER (CONTINUED)

3. How to set the ON time

(Example) To start operation at 7:10 am.



Operation	Indication
1. Press the ON TIME setting button once.	The timer ON indication is displayed, and the present ON time is shown.
2. Press the Advance, Return (▲, ▼) button until AM 7:10 is displayed.	The timer ON indication blinks. The time can be set in 10-minute increments. Holding down the button advances the time rapidly in 10-minute increments.
3. Wait a few seconds, and then the setting is complete.	The timer ON indication stops blinking and the present time is displayed.

4. How to set DAILY ON/OFF REPEAT timer

(Example) To start operation at 7:10 am. and stop the air conditioner at 11:00 am.

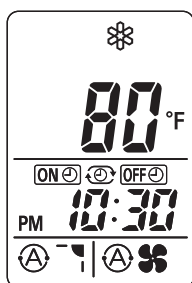

Operation	Indication
1. Set the timer ON/OFF times as shown in 2-1, 2, 3 and 3-1, 2, 3.	The present time 10:30 pm. and ON OFF are displayed.

NOTE

- The ON/OFF combination timer uses the current time as the reference, and it is activated starting from whichever set time comes first.
- With the ON/OFF combination timer, the settings are repeated every day.
- You can check the timer ON/OFF times after you have set them by pressing the ON TIME and OFF TIME setting buttons.

To cancel a timer program

- Press the CANCEL button.
- When either an ON or OFF timer is to be canceled, press the button corresponding to the timer whose program is to be canceled, and then press the CANCEL button.

NOTE

- The airflow direction, fan speed and temperature setting can be changed after a timer program has been set even when the unit is stopped. Even when operation is stopped during an ON timer program, the unit will start operating when the set time is reached provided that the program is not canceled.
- When the ON timer and OFF timer are set to the same time, the timer operates as if it is turned off.

USING THE 1-HOUR OFF TIMER

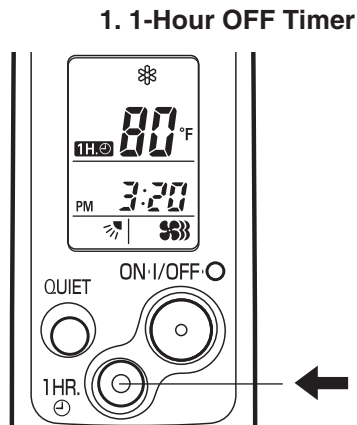

This function causes the unit to operate for one hour and then stop, regardless of whether the unit is on or off when this button is pressed. The **1HR.Ⓢ** indicator in the display indicates that this function is operating.

Setting procedure:

Regardless of whether the unit is operating or stopped, press the 1 HR. TIMER button.

1HR.Ⓢ appears in the display.

Cancellation procedure:

Press the ON/OFF operation button to turn the unit off, wait for the unit to stop operating, and then press the ON/OFF operation button again.

The 1-Hour Timer function is now cancelled and the unit operates normally.

NOTE

- If, while the 1-Hour Timer function is operating, the 1HR. TIMER button is pressed once to cancel the function and then again, the unit continues to operate for one hour from that point in time and then stops.
- It is not possible to use the OFF Timer and 1-Hour OFF Timer together. Whichever function is set last takes precedence. If the 1 HR. TIMER button is pressed while the TIMER OFF function operates, the OFF Timer is cancelled and the unit will stop operating one hour later.

2. Operation together with the DAILY ON/OFF REPEAT Timer

The 1-Hour OFF Timer setting is given priority over the DAILY ON/OFF REPEAT setting.

TIPS FOR ENERGY SAVING

- Avoid**
- **Do not block neither the air intake nor the air outlet. It may cause less performance, and may leads to malfunctions.**
 - Do not let direct sunlight into the room. Use sunshades, blinds or curtains. If the walls and ceiling of the room are warmed by the sun, it will take longer to cool the room.
- Do**
- Always try to keep the air filter clean. (Refer to “CARE AND CLEANING”.) A clogged filter will impair the performance of the unit.
 - To prevent conditioned air from escaping, keep windows, doors and any other openings closed.

ADJUSTING THE AIRFLOW DIRECTION

- 1. Horizontal** The horizontal airflow can be adjusted by moving the vertical vanes with your hands to the left or right.

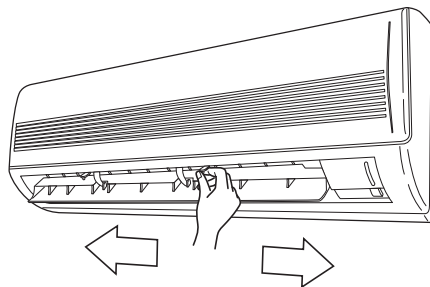

CAUTION

When the humidity is high, the vertical vanes should be in the front position during the cooling or dehumidifying operation. If the vertical vanes are positioned all of the way to the right or left, condensation may begin to form around the air vent and drip down.

- 2. Vertical** The vertical airflow can be adjusted by moving the flap with the remote controller. Do not move the flap with your hands. Confirm that the remote controller has been turned on. Use the FLAP button to set either the sweep function or one of the six airflow direction settings.

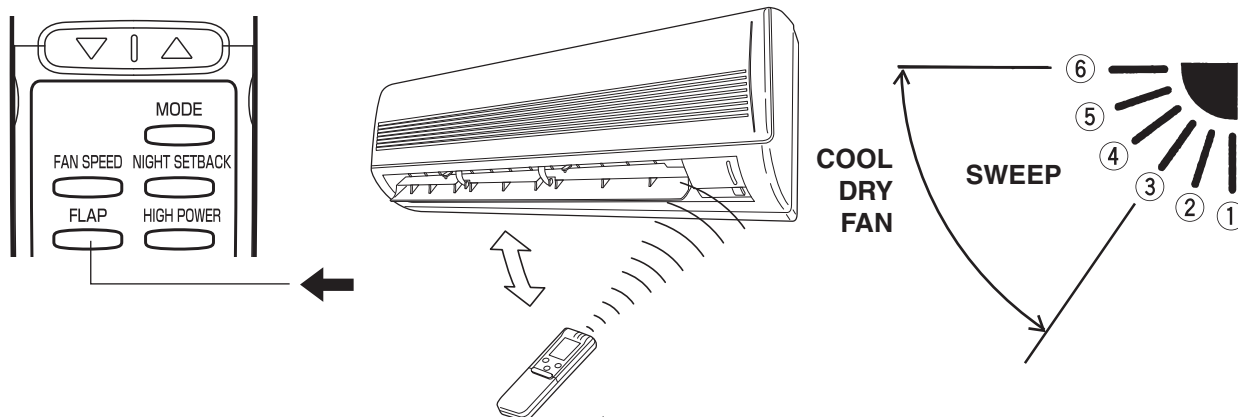

A. Sweep function



The flap starts moving up and down to deliver air over the sweep range.

C. Auto flap function



The flap is set to the recommended position.

B. Setting the airflow manually



Referring to the above illustration, use the FLAP button to set the airflow direction within the range used during the cooling or dehumidifying operation.

NOTE

- The flap automatically closes when the unit is off.



CAUTION

- Use the FLAP button on the remote controller to adjust the position of the flap. If you move the flap by hand, the flap position according to the remote controller and the actual flap position may no longer match. If this should happen, shut off the unit, wait for the flap to close, and then turn on the unit again; the flap position will now be normal again.
- Do not have the flap pointed down during cooling operation. Condensation may begin to form around the air vent and drip down.

OPERATION WITHOUT THE REMOTE CONTROLLER

INDOOR UNIT

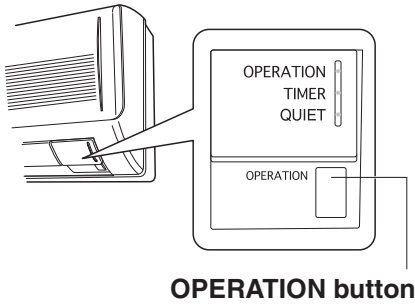

If you have lost the remote controller or it has trouble, follow the steps below.

When the air conditioner is not running

Each time the OPERATION button is pressed, the operation mode changes cyclically.



NOTE

The temperature is set to the room temperature minus 4 °F during the cooling operation, and the fan speed and flap are set to Auto.

CARE AND CLEANING



WARNING

1. For safety, be sure to turn the air conditioner off and also to disconnect the power before cleaning.
2. Do not pour water on the indoor unit to clean it. This will damage the internal components and cause an electric shock hazard.

Casing and Grille (Indoor Unit)

Clean the casing and grille of the indoor unit with a vacuum cleaner brush, or wipe them with a clean, soft cloth.

If these parts are stained, use a clean cloth moistened with a mild liquid detergent. When cleaning the grille, be careful not to force the vanes out of place.



CAUTION

1. Never use solvents, or harsh chemicals when cleaning the indoor unit. Do not wipe the plastic casing using very hot water.
2. Some metal edges and the fins are sharp and may cause injury if handled improperly; be especially careful when you clean these parts.
3. The internal coil and other components of the outdoor unit must be cleaned every year. Consult your dealer or service center.

CARE AND CLEANING (CONTINUED)

Filter The filter behind the air intake grille should be checked and cleaned at least once every two weeks.

How to remove the filter

1. Grasp both ends of the air intake grille, and remove it by opening towards the front and pulling towards you.

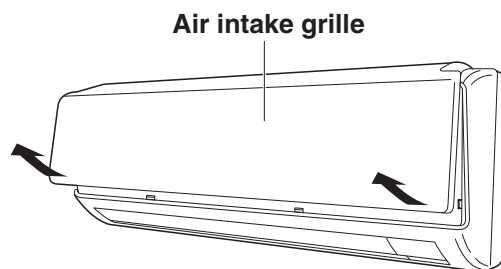

2. Remove the filter attached to the rear of the air intake grille.

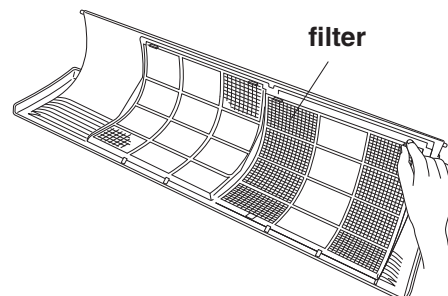

Cleaning Use a vacuum cleaner to remove light dust. If there is sticky dust on the filter, wash the filter in lukewarm, soapy water, rinse it in clean water, and dry it.

How to replace the filter

1. With the FRONT mark of the filter at the front, align the two indentions near the mark with the hooks at the rear of the air intake grille, and then mount the filter.

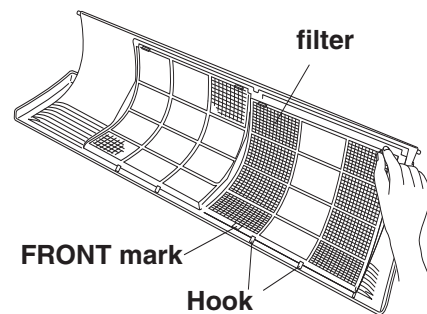

2. Allow the edge of the air intake grille to slide into the top of the indoor unit, and then insert it all the way inside.

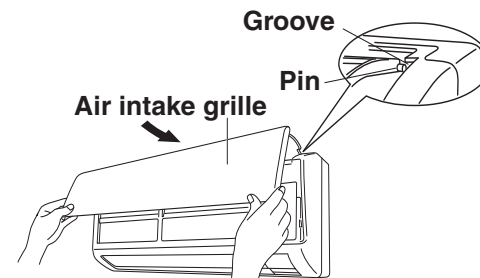

3. To attach the air intake grille to the indoor unit, press its bottom right and left corners as well as its bottom center into place.

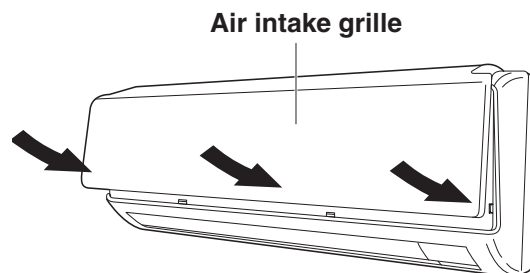

NOTE

Attach so that the round pins at the top right and left corners of the air intake grille are inserted into the grooves at the top right and left of the indoor unit.

CARE AND CLEANING (CONTINUED)

Cleaning the main unit and Remote Controller

- Wipe clean using a soft, dry cloth.
- To remove stubborn dirt, moisten a cloth in warm water no hotter than 104 °F, wring thoroughly, and then wipe.
- The air intake grille can be removed in order to wash it with water.

Removing and remounting the air intake grille

Refer to “How to remove the filter” and “How to replace the filter” on page 22.



CAUTION

When using a footstool or the like, be careful not to let it tip over.

EG

Washing the grille with water

- Clean the grille gently using a soft sponge, or the like. Then wipe away any remaining moisture.
- Neutral detergent may be used to remove stubborn dirt. Then rinse thoroughly with water and wipe away any remaining moisture.

WIRED REMOTE CONTROLLER

A separately sold wired remote controller (CZ-RD515U) used with this air conditioner is also available. If you wish to use the wired remote control function, you will need to purchase both the optional wired remote controller and its connection kit (CZ-RC515U).

TROUBLESHOOTING (BEFORE CALLING FOR SERVICE)

If your air conditioner does not work properly, first check the following points before requesting service. If it still does not work properly, contact your dealer or service center.

Trouble	Possible Cause	Remedy
Air conditioner does not run at all.	<ol style="list-style-type: none"> 1. Power failure. 2. Leakage circuit breaker tripped. 3. Line voltage is too low. 4. Batteries in remote controller have run down. 	<ol style="list-style-type: none"> 1. Restore power. 2. Contact service center. 3. Consult your electrician or dealer. 4. Replace batteries.
OPERATION lamp blinks and air conditioner does not operate.	Trouble in system.	Contact service center.
Compressor runs but soon stops.	Obstruction in front of condenser coil. (Outdoor Unit)	Remove obstruction.
Poor cooling performance.	<ol style="list-style-type: none"> 1. Dirty or clogged air filter. 2. Heat source or many people in room. 3. Doors and/or windows are open. 4. Obstacle near air intake or air discharge port. 5. Thermostat is set too high for cooling. 	<ol style="list-style-type: none"> 1. Clean air filter to improve airflow. 2. Eliminate heat source if possible. 3. Shut them to keep the heat out. 4. Remove it to ensure good airflow. 5. Set the temperature lower.
Clicking sound is heard from the air conditioner.	In cooling operation, any plastic parts may shrink due to a sudden temperature change. In this event, a clicking sound may occur.	This is normal, and the sound will soon disappear.
OPERATION lamp lights but outdoor unit will not run.	The use of cellular phones near the air conditioner may cause disturbance to its normal operation.	<ol style="list-style-type: none"> 1. Turn off the power then restart the air conditioner after a while. 2. Consult your dealer.

OPERATING RANGE

The air conditioner is operable within the temperature ranges as listed below:

For Cooling Only Models : CU-KS18NKU, CU-KS24NKU

	Temperature	Indoor air temperature	Outdoor air temperature
COOLING	Max.	95 °F DB / 71 °F WB	115 °F DB
	Min.	67 °F DB / 57 °F WB	67 °F DB

For Low Ambient Cooling Models : CU-KS18NKUA, CU-KS24NKUA

	Temperature	Indoor air temperature	Outdoor air temperature
COOLING	Max.	95 °F DB / 71 °F WB	115 °F DB
	Min.	67 °F DB / 57 °F WB	0 °F DB

SPECIFICATIONS

Model No.			Outdoor Unit		Indoor Unit		
			CU-KS18NKU, CU-KS18NKUA		CS-KS18NKU		
Power Source			Single-phase, 208-230 V, 60 Hz				
Cooling Capacity			kW	5.15 [1.20 ~ 5.15]			
			BTU/h	17,500 [4,000 ~ 17,500]			
Heating Capacity			kW	-			
			BTU/h	-			
Operation Sound	Cooling Operation	Outdoor (Hi)	dB(A)	51			
		Indoor(H/M/L)		-			
	Heating Operation	Outdoor (Hi)	dB(A)	-			
		Indoor(H/M/L)		-			
Unit Dimensions (HxWxD) (Indoor unit : Include panel)			inch(mm)	26-3/8x34-21/32x11-7/32 (670x880x285)		11-23/32x41-15/16x8-5/8 (298x1,065x219)	
Net Weight			lbs.(kg)	90.4(41.0)		26.5(12.0)	

Model No.			Outdoor Unit		Indoor Unit		
			CU-KS24NKU, CU-KS24NKUA		CS-KS24NKU		
Power Source			Single-phase, 208-230 V, 60 Hz				
Cooling Capacity			kW	7.10 [1.20 ~ 7.10]			
			BTU/h	24,200 [4,000 ~ 24,200]			
Heating Capacity			kW	-			
			BTU/h	-			
Operation Sound	Cooling Operation	Outdoor (Hi)	dB(A)	55			
		Indoor(H/M/L)		-			
	Heating Operation	Outdoor (Hi)	dB(A)	-			
		Indoor(H/M/L)		-			
Unit Dimensions (HxWxD) (Indoor unit : Include panel)			inch(mm)	29-1/8x35-7/16x12-19/32 (740x900x320)		11-23/32x41-15/16x8-5/8 (298x1,065x219)	
Net Weight			lbs.(kg)	119.0(54.0)		26.5(12.0)	

EG

APPENDIX B INSTALLATION INSTRUCTIONS

**CS-KS18NKU + CU-KS18NKU
+ CU-KS18NKUA**

**CS-KS24NKU + CU-KS24NKU
+ CU-KS24NKUA**

(852-6-4190-576-00-0)

INSTALLATION INSTRUCTIONS

Split System Air Conditioner

This air conditioner uses the refrigerant R410A.

Contents

NOTE External diameter of service port R410A: 5/16"

Page

Model Combinations

Combine indoor and outdoor units only as listed below.

Model No.

Indoor Unit	Outdoor Unit
CS-KS18NKU	CU-KS18NKU
	CU-KS18NKUA
CS-KS24NKU	CU-KS24NKU
	CU-KS24NKUA

Power Source:
60 Hz, single-phase, 230/208 V

IMPORTANT!

Please Read Before Starting 2

1. GENERAL 4

- 1-1. Tools Required for Installation (not supplied)
- 1-2. Accessories Supplied with Unit
- 1-3. Optional Copper Tubing Kit
- 1-4. Type of Copper Tube and Insulation Material
- 1-5. Additional Materials Required for Installation

2. INSTALLATION SITE SELECTION 5

- 2-1. Indoor Unit
- 2-2. Outdoor Unit
- 2-3. Baffle Plate for the Outdoor Unit

3. HOW TO INSTALL THE INDOOR UNIT 10

- 3-1. Remove the Rear Panel from the Unit
- 3-2. Make a Hole
- 3-3. Install the Rear Panel on the Wall
- 3-4. Remove the Grille to Install the Indoor Unit
- 3-5. Shape the Indoor Side Tubing
- 3-6. Wiring Instructions
- 3-7. Recommended Wire Length and Diameter
- 3-8. Wiring Instructions for Inter-unit Connections
- 3-9. Mounting
- 3-10. Drain Hose

4. HOW TO INSTALL THE OUTDOOR UNIT 20

- 4-1. Wiring Instructions for the Outdoor Unit

5. REFRIGERANT TUBING 21

- 5-1. Use of the Flaring Method
- 5-2. Flaring Procedure with a Flare Tool
- 5-3. Caution before Connecting Tubes Tightly
- 5-4. Connecting Tubing between Indoor and Outdoor Units
- 5-5. Insulation of Refrigerant Tubing
- 5-6. Taping the Tubes
- 5-7. Finishing the Installation

6. AIR PURGING 23

- Air Purging with a Vacuum Pump (for Test Run)
- Basic Functions of the Service Valves
- Pump Down
- Service Valve Connections

7. REMOTE CONTROLLER INSTALLATION POSITION 27

- 7-1. Mounting on a Wall

8. ADDRESS SWITCH 28

- 8-1. Address Setting of the Remote Controller

IMPORTANT!

Please Read Before Starting

This air conditioning system meets strict safety and operating standards. As the installer or service person, it is an important part of your job to install or service the system so it operates safely and efficiently.

For safe installation and trouble-free operation, you must:

- Carefully read this instruction booklet before beginning.
- Follow each installation or repair step exactly as shown.
- Observe all local, state, and national electrical codes.
- Pay close attention to all warning and caution notices given in this manual.



WARNING

This symbol refers to a hazard or unsafe practice which can result in severe personal injury or death.



CAUTION

This symbol refers to a hazard or unsafe practice which can result in personal injury or product or property damage.

If Necessary, Get Help

These instructions are all you need for most installation sites and maintenance conditions. If you require help for a special problem, contact our sales/service outlet or your certified dealer for additional instructions.

In Case of Improper Installation

The manufacturer shall in no way be responsible for improper installation or maintenance service, including failure to follow the instructions in this document.

SPECIAL PRECAUTIONS

WARNING When Wiring



ELECTRICAL SHOCK CAN CAUSE SEVERE PERSONAL INJURY OR DEATH. ONLY A QUALIFIED, EXPERIENCED ELECTRICIAN SHOULD ATTEMPT TO WIRE THIS SYSTEM.

- Do not supply power to the unit until all wiring and tubing are completed or reconnected and checked.
- Highly dangerous electrical voltages are used in this system. Carefully refer to the wiring diagram and these instructions when wiring. Improper connections and inadequate grounding can cause **accidental injury or death**.
- **Ground the unit** following local electrical codes.
- Connect all wiring tightly. Loose wiring may cause overheating at connection points and a possible fire hazard.
- To prevent possible hazards from insulation failure,  the unit must be grounded.

When Transporting

Be careful when picking up and moving the indoor and outdoor units. Get a partner to help, and bend your knees when lifting to reduce strain on your back. Sharp edges or thin aluminum fins on the air conditioner can cut your fingers.

When Installing...

Select an installation location which is rigid and strong enough to support or hold the unit, and select a location for easy maintenance.

...In a Ceiling or Wall

Make sure the ceiling/wall is strong enough to hold the unit's weight. It may be necessary to construct a strong wood or metal frame to provide added support.

...In a Room

Properly insulate any tubing run inside a room to prevent "sweating" that can cause dripping and water damage to walls and floors.



CAUTION

Keep the fire alarm and the air outlet at least 1.5 m away from the unit.

...In Moist or Uneven Locations

Use a raised concrete pad or concrete blocks to provide a solid, level foundation for the outdoor unit. This prevents water damage and abnormal vibration.

...In an Area with High Winds

Securely anchor the outdoor unit down with bolts and a metal frame. Provide a suitable air baffle.

...In a Snowy Area (for Heat Pump-type Systems)

Install the outdoor unit on a raised platform that is higher than drifting snow. Provide snow vents.

When Connecting Refrigerant Tubing



WARNING

- When performing piping work do not mix air except for specified refrigerant (R410A) in refrigeration cycle. It causes capacity down, and risk of explosion and injury due to high tension inside the refrigerant cycle.
- Refrigerant gas leakage may cause fire.
- Do not add or replace refrigerant other than specified type. It may cause product damage, burst and injury etc.
- Ventilate the room well, in the event that refrigerant gas leaks during the installation. Be careful not to allow contact of the refrigerant gas with a flame as this will cause the generation of poisonous gas.



- Use the flare method for connecting tubing.
- Apply refrigerant lubricant to the matching surfaces of the flare and union tubes before connecting them, then tighten the nut with a torque wrench for a leak-free connection.
- Check carefully for leaks before starting the test run.
- Do not leak refrigerant while piping work for an installation or re-installation, and while repairing refrigeration parts. Handle liquid refrigerant carefully as it may cause frost-bite.

When Servicing

- Turn the power OFF at the main power box (mains) before opening the unit to check or repair electrical parts and wiring. 
- Keep your fingers and clothing away from any moving parts.
- Clean up the site after you finish, remembering to check that no metal scraps or bits of wiring have been left inside the unit being serviced.

Others



- Ventilate any enclosed areas when installing or testing the refrigeration system. Escaped refrigerant gas, on contact with fire or heat, can produce dangerously toxic gas.
- Confirm upon completing installation that no refrigerant gas is leaking. If escaped gas comes in contact with a stove, gas water heater, electric room heater or other heat source, it can produce dangerously toxic gas.
- Do not touch the air inlet or the sharp aluminum fins of the outdoor unit. You may get injured. 
- Do not sit or step on the unit, you may fall down accidentally. 
- Do not stick any object into the FAN CASE. You may be injured and the unit may be damaged. 



NOTE

The illustrations are based on the typical appearance of a standard model. Consequently, the shape may differ from that of the air conditioner that you are installing.

1. General

This booklet briefly outlines where and how to install the air conditioning system. Please read over the entire set of instructions for the indoor and outdoor units and make sure all accessory parts listed are with the system before beginning.







1-1. Tools Required for Installation (not supplied)

1. Standard screwdriver
2. Phillips head screwdriver
3. Knife or wire stripper
4. Tape measure
5. Carpenter's level

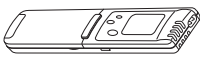
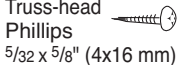
6. Sabre saw or key hole saw
7. Hacksaw
8. Core bits
9. Hammer
10. Drill
11. Tube cutter
12. Tube flaring tool
13. Torque wrench
14. Adjustable wrench
15. Reamer (for deburring)

1-2. Accessories Supplied with Unit

Table 1

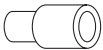
Parts	Figure	Q'ty	Parts	Figure	Q'ty	Parts	Figure	Q'ty
Remote controller		1	Tapping screw		10	Clamp		1
Remote control holder		1	Rawl plug		8	Cushion rubber*		4
AAA alkaline battery		2	Drain hose adapter		1	*Packed in the outdoor unit.		

1-3. Optional Copper Tubing Kit

Copper tubing for connecting the outdoor unit to the indoor unit is available in kits which contain the narrow and wide tubing, fittings and insulation. Consult your nearest sales outlet or air conditioning workshop.

1-4. Type of Copper Tube and Insulation Material

If you wish to purchase these materials separately from a local source, you will need:

1. Deoxidized annealed copper tube for refrigerant tubing as detailed in Table 2.
Cut each tube to the appropriate lengths 1' to 1'4" (30 cm to 40 cm) to dampen vibration between units.

2. Foamed polyethylene insulation for the specified copper tubes as required to precise length of tubing. Wall thickness of the insulation should be not less than 5/16" (8 mm).
3. Use insulated copper wire for field wiring. Wire size varies with the total length of wiring. Refer to 3-6. Wiring Instructions for details.



CAUTION

Check local electrical codes and regulations before obtaining wire. Also, check any specified instructions or limitations.

Table 2

Model	Narrow Tube		Wide Tube	
	Outer Dia.	Thickness	Outer Dia.	Thickness
CS-KS18NKU	1/4" (6.35 mm)	0.0314" (0.8 mm)	1/2" (12.70 mm)	0.0314" (0.8 mm)
CS-KS24NKU	1/4" (6.35 mm)	0.0314" (0.8 mm)	5/8" (15.88 mm)	0.0393" (1.0 mm)

1-5. Additional Materials Required for Installation

1. Refrigeration (armored) tape
2. Insulated staples or clamps for connecting wire
(See local codes.)
3. Putty
4. Refrigeration lubricant
5. Clamps or saddles to secure refrigerant tubing

2. Installation Site Selection

2-1. Indoor Unit



WARNING

To prevent abnormal heat generation and the possibility of fire, do not place obstacles, enclosures and grilles in front of or surrounding the air conditioner in a way that may block air flow.

AVOID:

- direct sunlight.
- nearby heat sources that may affect performance of the unit.
- areas where leakage of flammable gas may be expected.
- places where large amounts of oil mist exist.

DO:

- select an appropriate position from which every corner of the room can be uniformly cooled. (High on a wall is best.)
- select a location that will hold the weight of the unit.
- select a location where tubing and drain hose have the shortest run to the outside. (Fig. 1)
- allow room for operation and maintenance as well as unrestricted air flow around the unit. (Fig. 2)
- install the unit within the maximum elevation difference (H) above or below the outdoor unit and within a total tubing length (L) from the outdoor unit as detailed in Table 3 and Fig. 3a.
- install the indoor unit more than 3.3' (1 m) away from any antenna or power lines or connecting wires used for television, radio, telephone, security system, or intercom. Electrical noise from any of these sources may affect operation.

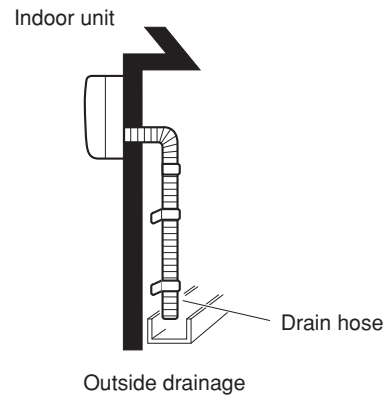
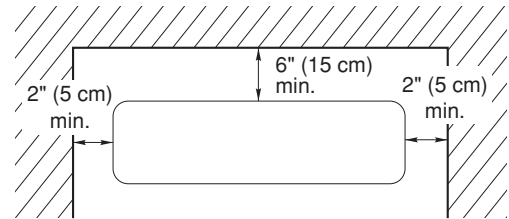

Fig. 1



Front View

Fig. 2

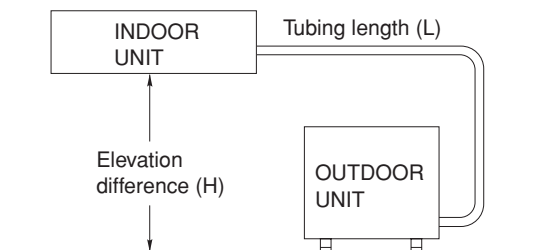

Fig. 3a



CAUTION

For stable operation of the air conditioner, do not install wall-mounted type indoor units less than 5' (1.5 m) from floor level.

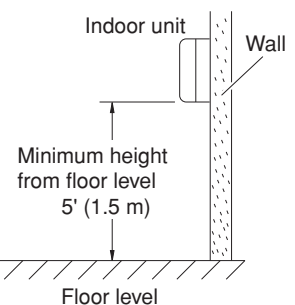

Fig. 3b

Table 3

Model	Max. Allowable Tubing Length at Shipment (ft.)	Limit of Tubing Length (L) (ft.)		Limit of Elevation Difference (H) (ft.)	Required Amount of Additional Refrigerant (oz./ft.)*
CS-KS18NKU	25	100		50	0.27
CS-KS24NKU	33	CU-KS24NKU	CU-KS24NKUA	50	0.27
		132	100		

* If total tubing length becomes 25 to 100 ft. (Max.) or 33 to 132 or 100 ft. (Max.), charge additional refrigerant (R410A) by 0.27 oz./ft. No additional charge of compressor oil is necessary. For more detailed charging information, refer to the Technical & Service Manual.

2-2. Outdoor Unit

AVOID:

- heat sources, exhaust fans, etc. (Fig. 4)
- damp, humid or uneven locations.

DO:

- choose a place as cool as possible.
- choose a place that is well ventilated.
- allow enough room around the unit for air intake/ exhaust and possible maintenance. (Fig. 5a or 5b)
- provide a solid base (level concrete pad, concrete block, 4" × 1'4" (10 × 40 cm) or 6" × 1'4" (15 × 40 cm) beams or equal), a minimum of 4" (10 cm) or 6" (15 cm) above ground level to reduce humidity and protect the unit against possible water damage and decreased service life. (Fig. 5c or 5d)
- install cushion rubber under unit's feet to reduce vibration and noise. (Fig. 5e)
- use lug bolts or equal to bolt down unit, reducing vibration and noise.
- install in a location where no antenna of a television or radio exists within 10' (3 m).

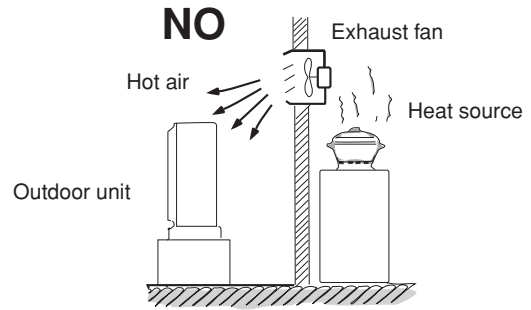

Fig. 4

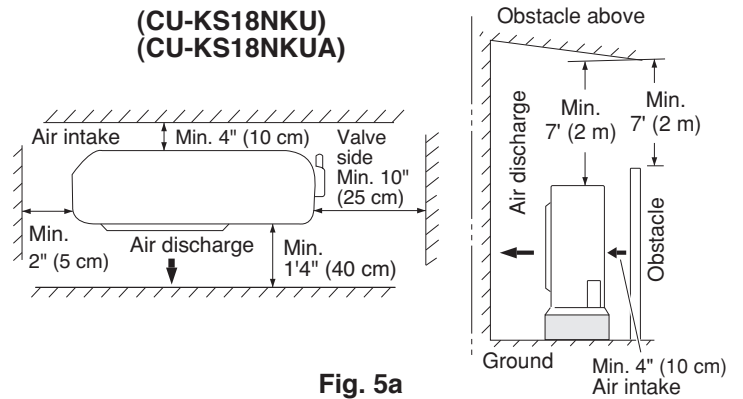

Fig. 5a

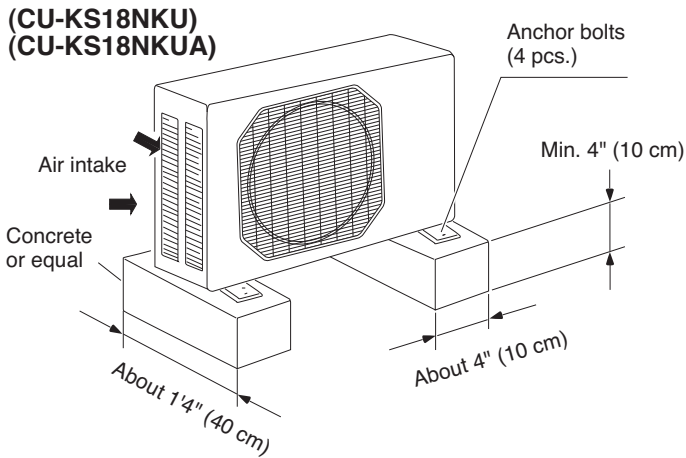

Fig. 5c

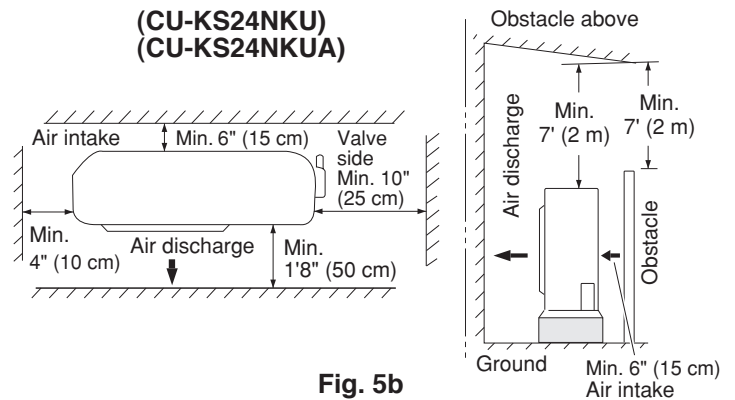

Fig. 5b

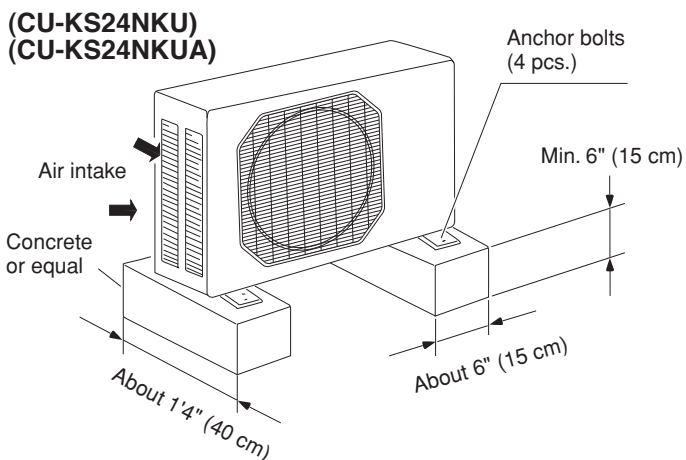

Fig. 5d

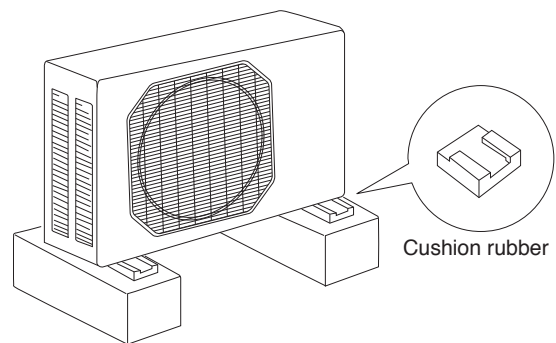

Fig. 5e

2-3. Baffle Plate for the Outdoor Unit (CU-KSxxNKUA models only)

NOTE

It is recommended to use baffle plates for models CU-KS18NKUA and CU-KS24NKUA. The baffle plates are not normally required for the other models.

When the outdoor unit is installed in a position exposed to strong wind (such as seasonal winds with low air temperature in winter), baffle plates must be installed on the outdoor unit. (Fig. 5f)

This unit is designed so that the fan of the outdoor unit runs at low speed when the air conditioner is operated at low outdoor air temperatures. When the outdoor unit is exposed to strong wind, the system pressure drops because of the freeze protector.

Install a pair of windbaffle plates at the front and back of the outdoor unit if it will be subject to strong wind during the winter. (Figs. 5f, 5g, 5h, 5i, and 5j)

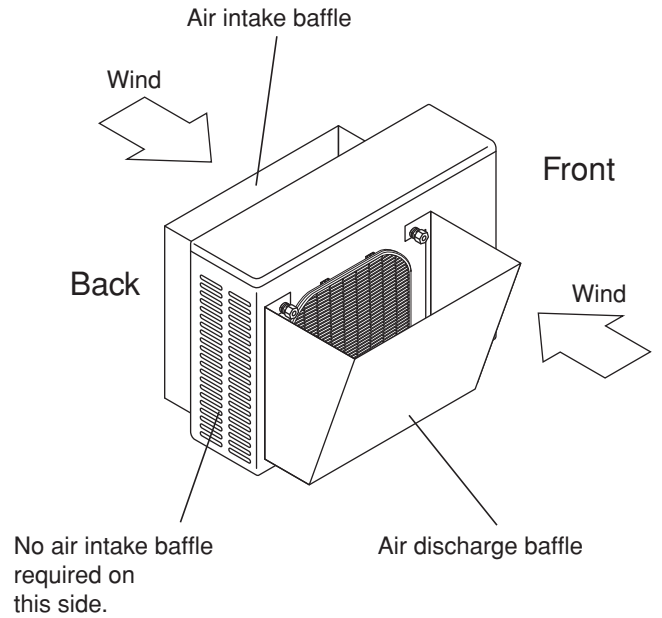

Fig. 5f

(1) Recommended dimensions of the baffle plates

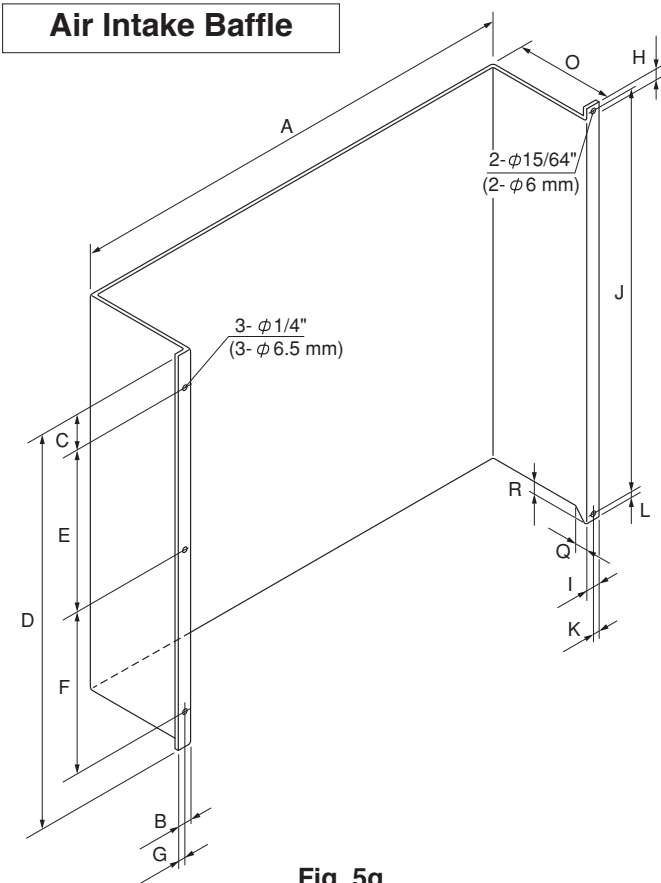

Fig. 5g

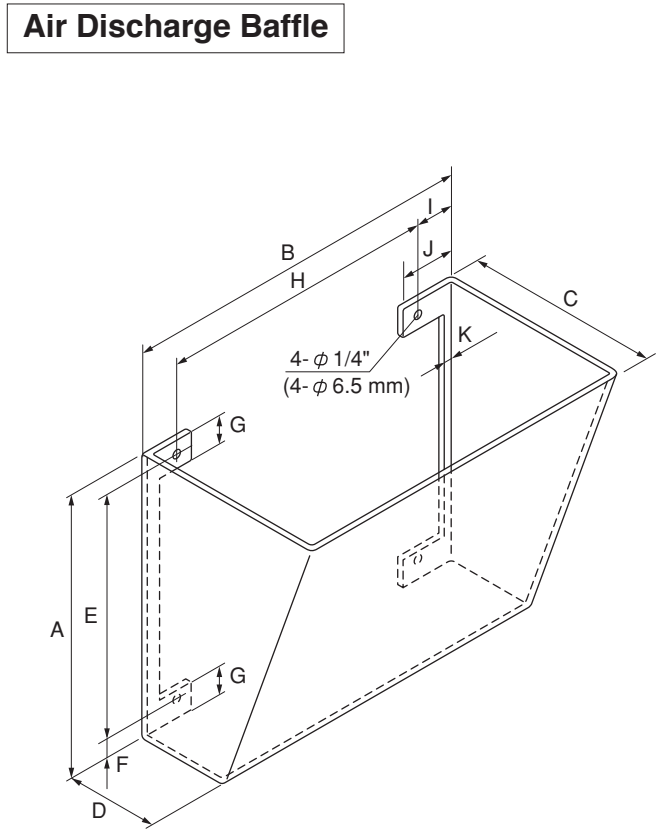

Fig. 5h

For Air Intake

Dimensions		A	B	C	D	E	F	G	H	I	J	K	L	O	Q	R
Model																
CU-KS18NKUA	(inch)	24-13/32	25/32	1-25/32	22-1/4	9-1/4	9-1/4	25/64	25/32	19/32	23-1/8	19/64	25/64	5-29/32	25/32	25/32
	(mm)	620	20	45	565	235	235	10	20	15	587	7.5	10	150	20	20
CU-KS24NKUA	(inch)	25-3/16	25/32	1-31/32	25	10-5/8	10-5/8	25/64	25/32	19/32	25-7/8	19/64	25/64	5-29/32	25/32	25/32
	(mm)	640	20	50	635	270	270	10	20	15	657	7.5	10	150	20	20

For Air Discharge

Dimensions		A	B	C	D	E	F	G	H	I	J	K
Model												
CU-KS18NKUA	(inch)	20-7/8	22-1/16	13-25/32	5-29/32	18-1/8	1-3/8	2-5/32	17-5/16	2-3/8	3-11/32	31/32
	(mm)	530	560	350	150	460	35	55	440	60	85	25
CU-KS24NKUA	(inch)	22-1/16	23-1/32	13-25/32	5-29/32	19-9/32	1-3/8	2-5/32	18-5/16	2-3/8	3-11/32	31/32
	(mm)	560	585	350	150	490	35	55	465	60	85	25

Material to be used: Metal plate with corrosion protection treatment

Plate thickness: 0.0394 to 0.0472" (1.0 to 1.2 mm)

(2) Parts required (field supply except for screws)

Air Intake Baffle

Item	Q'ty	Remarks
Baffle plate	1	
Screw 5/32 × 15/32" (4 × 12 mm) tapping	2	Attached to outdoor unit
Bolt 15/64 × 19/32 – 25/32" (M6 × 15 – 20 mm)	3	
Nut 15/64" (M6)	3	
Washer	3	
Spring washer	3	

Air Discharge Baffle

Item	Q'ty	Remarks
Baffle plate	1	
Bolt 15/64 × 13/32 – 19/32" (M6 × 10 – 15 mm)	4	
Nut 15/64" (M6)	4	
Washer	4	
Spring washer	4	

(3) Installation procedure

1. Air Intake Baffle

(1) Left side

1. Remove the top panel from the unit.
2. Remove the panel side L, and drill 3 holes of $\varnothing 1/4$ inch (6.5 mm) at the prescribed positions.
3. Install the windbaffle on the unit using field supply bolts and nuts.
4. Recommended bolts to be used are 15/64" (M6 ISO standard), and the recommended length of the bolts is between 19/32 – 25/32 inch (15 – 20 mm).
5. Use washers and spring washers to tightly fasten the windbaffle to the unit.

(2) Right side

1. Remove the top panel from the unit.
2. Use 2 preholes on the panel side R to install the baffle plate.
3. Remove the panel side R from the unit by removing the screws. These screws are used in step 4 below.
4. Put (sandwich) the windbaffle between the unit and the panel side R, then install the windbaffle on the unit using the above screws. Be careful not to damage the screw holes.

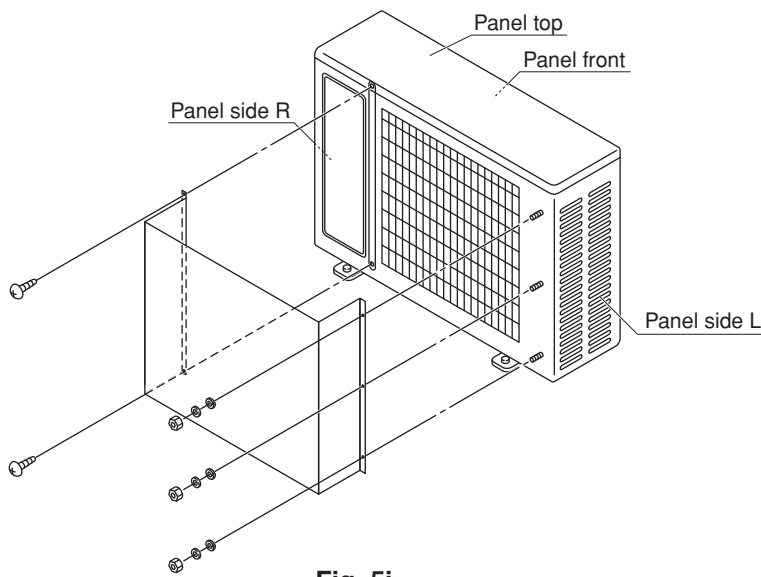

Fig. 5i

2. Air Discharge Baffle

1. Remove the panels front, top, side L and R from the unit and drill 4 holes of $\varnothing 1/4$ inch (6.5 mm) at the prescribed positions.
2. Install the windbaffle on the unit using field supply bolts and nuts.
3. Recommended bolts to be used are 15/64" (M6 ISO standard), and the recommended length of the bolts is between 13/32 – 19/32 inch (10 – 15 mm).
4. Use washers and spring washers to tightly fasten the windbaffle to the unit.

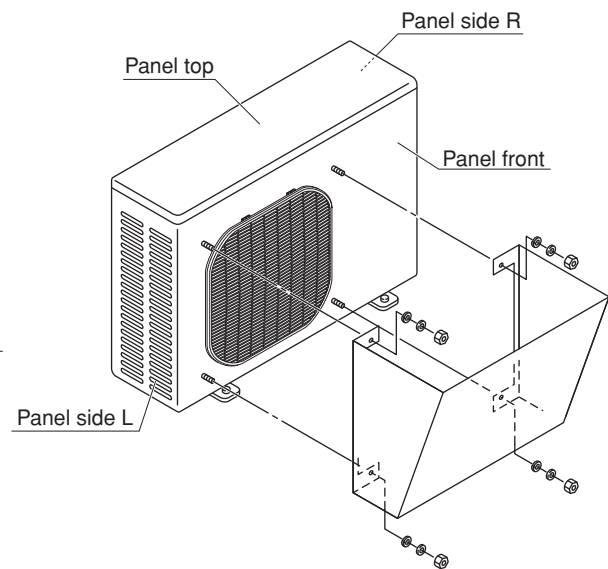

Fig. 5j

NOTE

- In order to prevent contact of the bolts and heat exchanger and other parts inside the unit, install the windbaffle using bolts from inside the unit and fasten the bolts with nuts from outside the unit.
- When the windbaffle is installed on the unit, the unit has higher wind resistance. In order to prevent the unit from falling over, anchor the legs of the unit using anchor bolts (or similar method).

(4) Precautions for installation

1. Be sure not to damage painted surfaces.
2. Finish the edges of the windbaffle to avoid cuts or injury.
3. Drilling of holes must be carefully done so that no damage is caused to external or internal parts of the unit. Particular care must be taken that drill chips do not drop into the unit.

3. How to Install the Indoor Unit

3-1. Remove the Rear Panel from the Unit

- (1) Remove and discard the set screw on the rear panel. (Fig. 6)
- (2) Press the 2 Δ marks on the frame cover and disengage the stationary tabs from the frame. (Fig. 7)
- (3) Remove the rear panel.

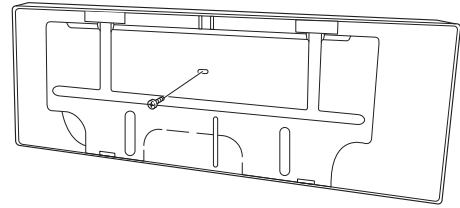

Set screw only for transportation

Fig. 6

NOTE

Tubing can be extended in 5 directions as shown in Fig. 8. Select the direction you need providing the shortest run to the outside unit.

- When left tubing is to be done, switch the drain hose and drain cap. (For details, refer to “Switching drain hose and drain cap” on page 18.)

3-2. Make a Hole

- (1) Place the rear panel from the indoor unit on the wall at the location selected. Make sure the panel is horizontal, using a carpenter’s level or tape measure to measure down from the ceiling. Wait until after cutting the hole before attaching the rear panel to the wall.
- (2) Determine which side of the unit you should make the hole for tubing and wiring. (Fig. 9)

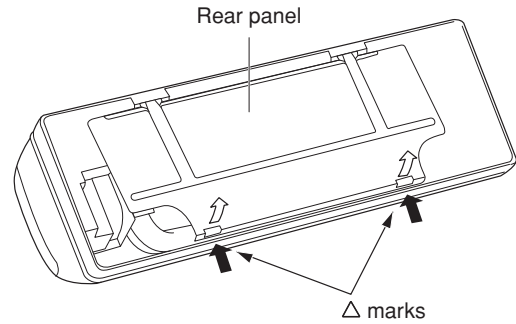

Fig. 7

NOTE

In the case of left-rear tubing, use the measurement points 2-3/8" (60 mm) from the edge of the rear panel for precise placement of the hose outlet. (Fig. 9)

- (3) Before making the hole, check carefully that no studs or pipes are directly run behind the spot to be cut.

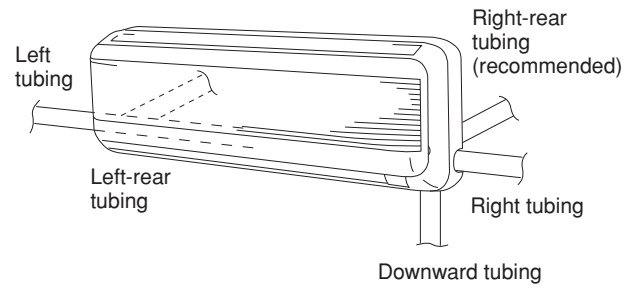

Fig. 8



CAUTION

Also avoid areas where electrical wiring or conduits are located.

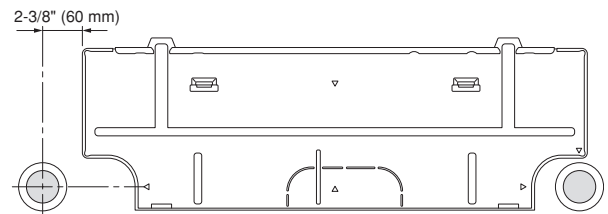

Fig. 9

The above precautions are also applicable if tubing goes through the wall in any other location.

- (4) Using a sabre saw, key hole saw or hole-cutting drill attachment, cut a hole in the wall. See Table 4 and Fig. 10.

Table 4

Hole Dia.
3-5/32" (80 mm)

- (5) Measure the thickness of the wall from the inside edge to the outside edge and cut PVC pipe at a slight angle 1/4" (6 mm) shorter than the thickness of the wall. (Fig. 11)
- (6) Place the plastic cover over the end of the pipe (for indoor side only) and insert the pipe in the wall. (Fig. 12)

3-3. Install the Rear Panel on the Wall

Be sure to confirm that the wall is strong enough to suspend the unit.

See either Item a) or b) below depending on the wall type.

a) If Wooden Wall

- (1) Attach the rear panel to the wall with the 8 screws provided. (Fig. 13)

If you are not able to line up the holes in the rear panel with the beam locations marked on the wall, use rawl plugs or toggle bolts to go through the holes on the panel or drill 3/16" (5 mm) dia. holes in the panel over the stud locations and then mount the rear panel.

- (2) Double check with a carpenter's level or tape measure that the panel is level. This is important to install the unit properly. (Fig. 14)
- (3) Make sure the panel is flush against the wall. Any space between the wall and unit will cause noise and vibration.

b) If Block, Brick, Concrete or Similar Type Wall

Make 3/16" (4.8 mm) dia. holes in the wall. Insert rawl plugs for appropriate mounting screws. (Fig. 15)

NOTE

Hole should be made at a slight downward slant to the outdoor side.

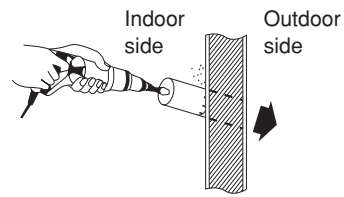
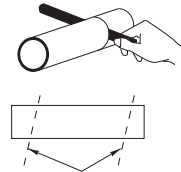

Fig. 10

PVC pipe (Locally purchased)



Cut at slight angle

Fig. 11

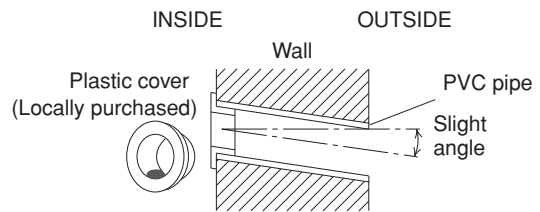

Fig. 12

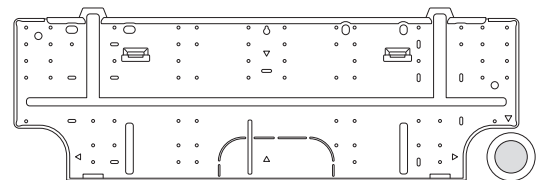

Fig. 13

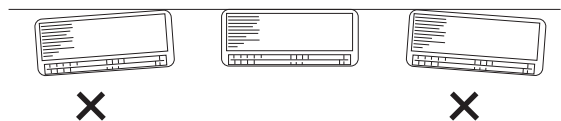

Fig. 14

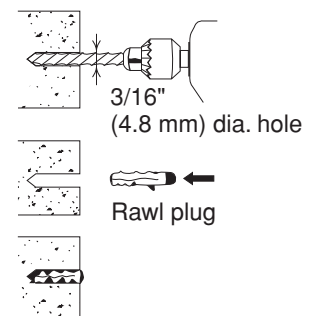

Fig. 15

3-4. Remove the Grille to Install the Indoor Unit

Basically, these models can be installed and wired without removing the grille. If access to any internal part is needed, follow the steps as given below.

How to remove the grille

- (1) Grasp both ends of the air intake grille, and remove it by opening towards the front and pulling towards you. (Fig. 16a)
- (2) Remove the 3 screws. (Fig. 16b)
- (3) Remove the screw on the right side cover plate and open the cover. (Fig. 17a)
- (4) Take out the thermistor from the grille. (Fig. 17b)
- (5) Press the 3 tabs at the top of the grille and the 3 tabs on the front face to separate the grille from the frame. (Fig. 18a)
- (6) Pull the grill toward you to remove it.

How to replace the grille

- (1) When installing the grille, place the bottom of the grille into the frame first. (Fig. 18b)
Then insert the tabs on the top of the grille and on the front face into the frame.
- (2) Make sure that the grille and frame are firmly fitted together by engaging the tabs.
- (3) Attach the thermistor on the grille. (Fig. 17a)
- (4) Close the cover and replace the screw. (Fig. 17a)
- (5) Affix the grille with the 3 previously removed screws. (Fig. 16b)
- (6) Install the air intake grille.
 - (a) Allow the edge of the air intake grille to slide into the top of the indoor unit, and then insert it all the way inside. (Fig. 19a)
 - (b) Press the bottom right and left corners and center of the air intake grille to attach it to the indoor unit. (Fig. 19b)

NOTE

Attach so that the round pins at the top right and left corners of the air intake grille are inserted into the grooves at the top right and left of the indoor unit.

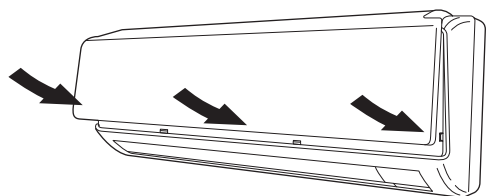

Fig. 19b

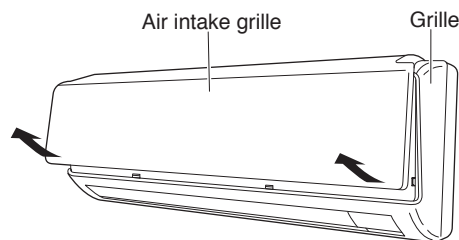

Fig. 16a

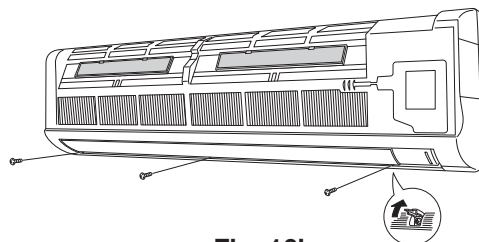

Fig. 16b

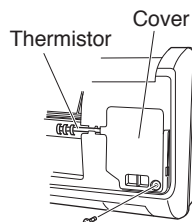

Fig. 17a

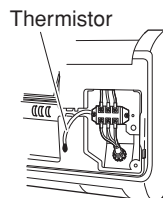

Fig. 17b

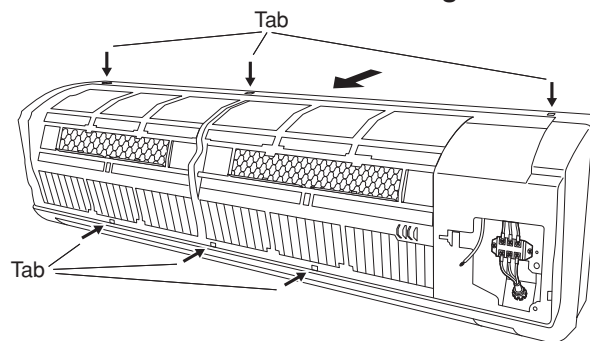

Fig. 18a

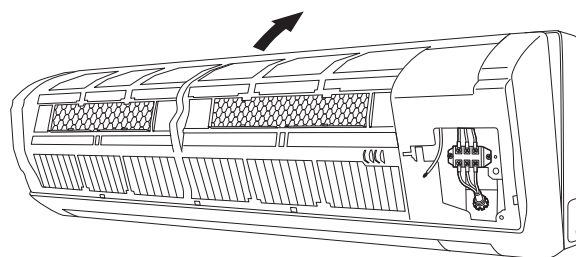

Fig. 18b

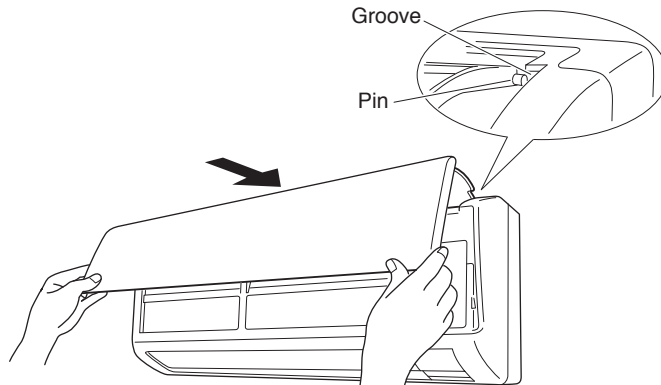

Fig. 19a

3-5. Shape the Indoor Side Tubing

(1) Arrangement of tubing by direction

a) Right or left tubing

Cut out the corner of the right/left frame with a hacksaw or the like. (Figs. 20 and 21)

b) Right-rear or left-rear tubing

In this case, the corner of the frame need not be cut.

(2) To mount the indoor unit on the rear panel:

Hang the 2 mounting slots of the unit on the upper tabs of the rear panel. (Fig. 22)

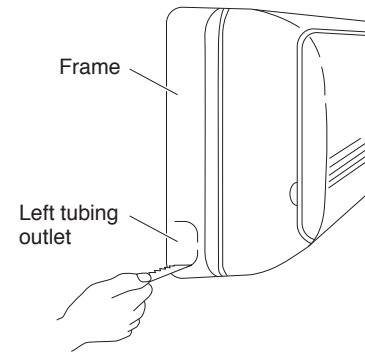

Fig. 20

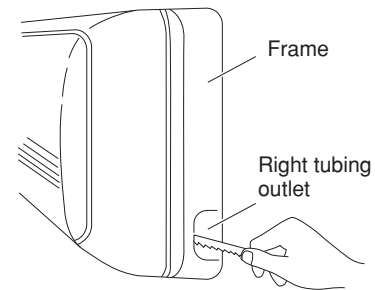

Fig. 21

3-6. Wiring Instructions

General precautions on wiring

- (1) Before wiring, confirm the rated voltage of the unit as shown on its nameplate, then carry out the wiring closely following the wiring diagram.
- (2) Provide a power outlet to be used exclusively for each unit, with a power supply disconnect and circuit breaker for overcurrent protection provided in the exclusive line.
- (3) To prevent possible hazards due to insulation failure, the unit must be grounded.
- (4) Each wiring connection must be done tightly and in accordance with the wiring system diagram. Wrong wiring may cause the unit to misoperate or become damaged.
- (5) Do not allow wiring to touch the refrigerant tubing, compressor, or any moving parts of the fan.
- (6) Unauthorized changes in the internal wiring can be very dangerous. The manufacturer will accept no responsibility for any damage or misoperation that occurs as a result of such unauthorized changes.

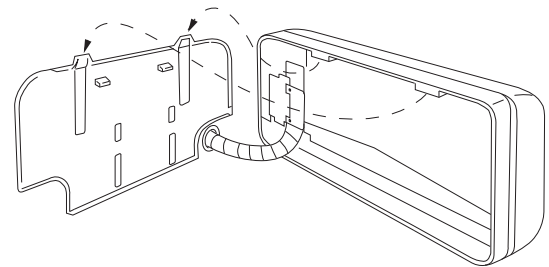

Fig. 22

3-7. Recommended Wire Length and Diameter

Regulations on wiring diameter differ from locality to locality. For field wiring requirements, please refer to your local electrical codes. Carefully observe these regulations when carrying out the installation.

Table 5 lists recommended wire lengths and diameters for power supply systems.

NOTE

Refer to the wiring system diagram (Fig. 23) for the meaning of (A), (B), and (C) in Table 5.

Refer to your local codes or in the absence of local codes see the National Electric Code: ANSI/NFPA70.

Table 5

Model \ AWG	(A)+(B) (A) Power Supply Wiring Length (ft) (B) Power Line Length (ft)		(C) Control Line Length (ft)	Fuse or Circuit Breaker Capacity
	(#14)	(#12)	(#14)	
CU-KS18NKU, CU-KS18NKUA	131 (Max.)	230 (Max.)	100 (Max.)	15A
CU-KS24NKU	131 (Max.)	230 (Max.)	132 (Max.)	20A
CU-KS24NKUA	131 (Max.)	230 (Max.)	100 (Max.)	20A

... AWG (American Wire Gauge)



WARNING

- Be sure to comply with local codes on running the wire from the indoor unit to the outdoor unit (size of wire and wiring method, etc.).
- Each wire must be firmly connected.
- No wire should be allowed to touch refrigerant tubing, the compressor, or any moving part.

WIRING SYSTEM DIAGRAM

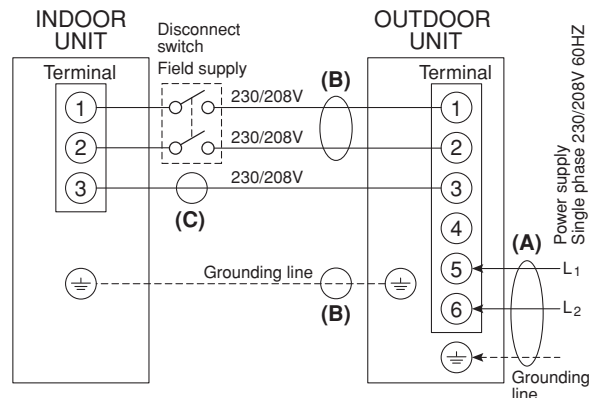

Fig. 23



WARNING

- To avoid the risk of electric shock, each air conditioner unit must be grounded.
- For the installation of a grounding device, please observe local electrical codes.
- Grounding is necessary, especially for units using inverter circuits, in order to release charged electricity and electrical noise caused by high tension. Otherwise, electrical shock may occur.
- Place a dedicated ground more than 7' (2 m) away from other grounds and do not have it shared with other electric appliances.

* NOTE

Disconnect switch may be required by national or local codes.



CAUTION

Always comply with national and local code requirements.



CAUTION

- Be sure to connect the power supply line to the outdoor unit as shown in the wiring diagram. The indoor unit draws its power from the outdoor unit.
- Do not run wiring for antenna, signal, or power lines of television, radio, stereo, telephone, security system, or intercom any closer than 3'4" (1 m) from the power cable and wires between the indoor and outdoor units. Electrical noise may affect the operation.

3-8. Wiring Instructions for Inter-unit Connections

- (1) Insert the inter-unit wiring (according to local codes) into the through-the-wall PVC pipe. Run the wiring toward the indoor side allowing approx. 10" (25 cm) to extend from the wall face. (Fig. 24)
- (2) Grasp both ends of the air intake grille, and remove it by opening towards the front and pulling towards you.
- (3) Remove the screw on the right side cover plate and open the cover. (Fig. 25)
- (4) Route the inter-unit wiring from the back of the indoor unit and pull it toward the front for connection. (Fig. 26a, 26b)
- (5) Connect the inter-unit wiring to the corresponding terminals on the terminal plate (Fig. 26a, 26b) while referring to the wiring diagram.
- (6) Be sure to secure the wiring with the provided clamp.

NOTE

When closing the air intake grille, press the bottom right and left corners and center. (Fig. 27)

Please refer to "How to replace the grille" on page 12 for installing the air intake grille.

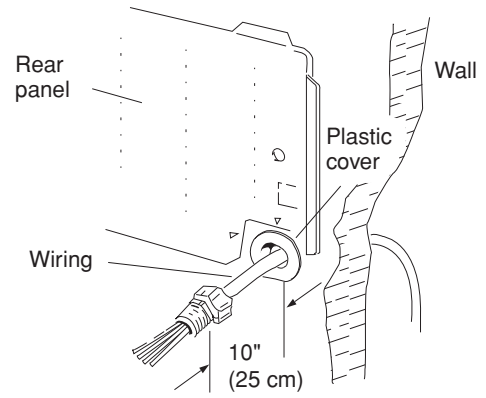

Fig. 24

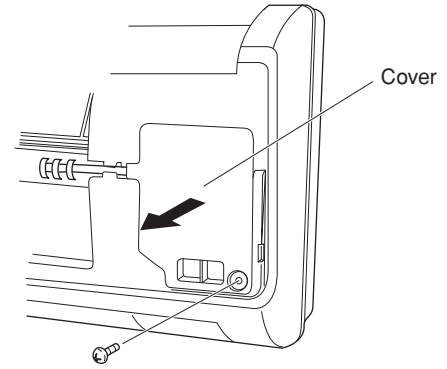

Fig. 25

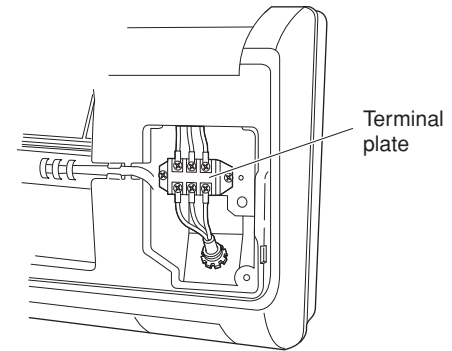

Fig. 26a

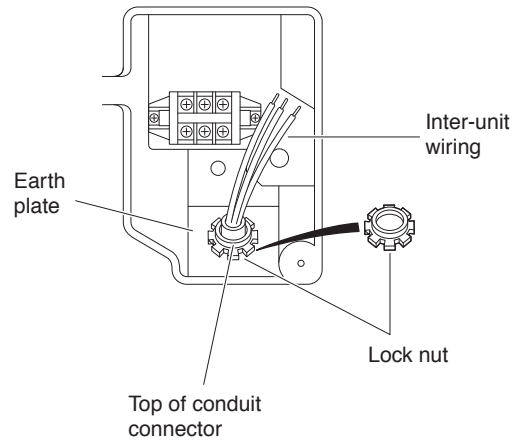

Fig. 26b

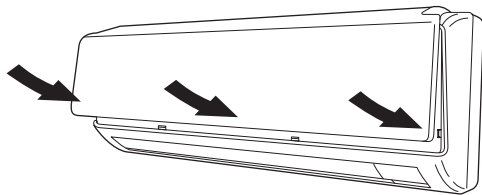

Fig. 27

**WARNING**

Loose wiring may cause the terminal to overheat or result in unit malfunction. A fire hazard may also exist. Therefore, be sure all wiring is tightly connected.

When connecting each power wire to the corresponding terminal, follow the instructions “How to connect wiring to the terminal” and fasten the wire securely tight with the fixing screw of the terminal plate.

How to connect wiring to the terminal**a) For Indoor Unit**

- (1) Cut the wire end with a cutting pliers, then strip the insulation to expose the wire about 9/32" (7 mm). See the label (Fig. 28) near the terminal plate.
- (2) Using a screwdriver, loosen the terminal screw on the terminal plate.
- (3) Insert the wire and tighten the terminal screw completely using a screwdriver.

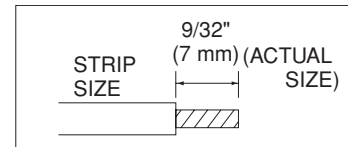
**Fig. 28****b) For Outdoor Unit****■ For solid core wiring (or F-cable)**

- (1) Cut the wire end with a cutting pliers, then strip the insulation to expose the solid wire about 15/16" (25 mm). (Fig. 29)
- (2) Using a screwdriver, remove the terminal screw(s) on the terminal plate.
- (3) Using the pliers, bend the solid wire to form a loop suitable for the terminal screw.
- (4) Shape the loop wire properly, place it on the terminal plate and fix it securely with the removed terminal screw using a screwdriver.

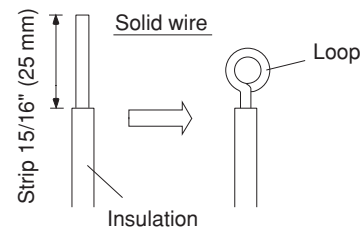
**Fig. 29****■ For stranded wiring**

- (1) Cut the wire end with a cutting pliers, then strip the insulation to expose the stranded wiring about 3/8" (10 mm) and tightly twist the wire ends. (Figs. 30 and 31)
- (2) Using a screwdriver, remove the terminal screw(s) on the terminal plate.
- (3) Using a ring connector fastener or pliers, securely clamp each stripped wire end with a ring connector. (Fig. 30)
- (4) Place the ring connector wire, and replace and tighten the removed terminal screw using a screwdriver. (Fig. 32)

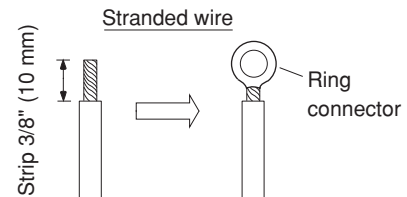
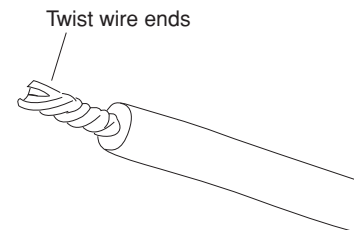
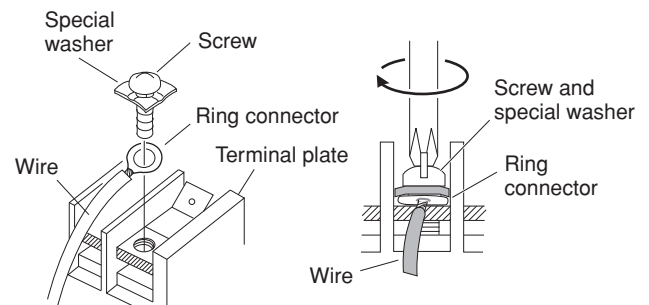
**Fig. 30****Fig. 31****Fig. 32**

3-9. Mounting

- (1) To install the indoor unit, mount the indoor unit onto the 2 tabs on the upper part of the rear plate.
- (2) Hold down the air discharge outlet and press the lower part of the indoor unit until it clicks to securely fasten to the 2 tabs on the lower part of the rear plate. (Fig. 33)

NOTE

For tubing, choose either the right or left tubing direction and follow the steps below. This work can be made easier by placing padding material (such as styrofoam) at the rear right side of the indoor unit. (Fig. 34)

■ Right-side tubing

- (1) Shape the refrigerant tubing so that it can easily go into the wall hole. (Fig. 35)
- (2) Push the wiring, refrigerant tubing, and drain hose through the hole in the wall. Adjust the indoor unit so it is securely seated on the rear panel. (Fig. 36)
- (3) Carefully bend the tubing (if necessary) to run along the wall in the direction of the outdoor unit and then tape as far as the fittings. (See Caution on page 21.) The drain hose should come straight down the wall to a point where water runoff won't stain the wall.
- (4) Connect the refrigerant tubing to the outdoor unit. (After performing a leak test on the connecting part, insulate it with the tubing insulation. (Fig. 37a)) Also, refer to Section 5-4. Connecting Tubing between Indoor and Outdoor Units.
- (5) Assemble the refrigerant tubing, drain hose, and conduit (including inter-unit wiring) as shown in Fig. 37b.

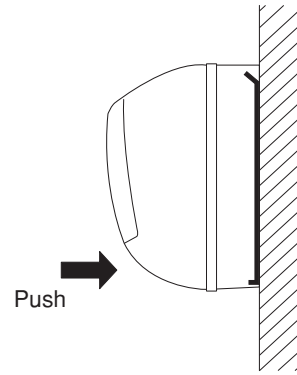

Fig. 33

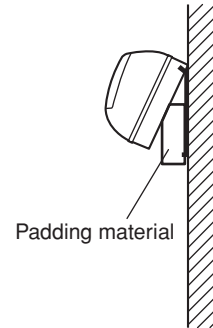

Fig. 34

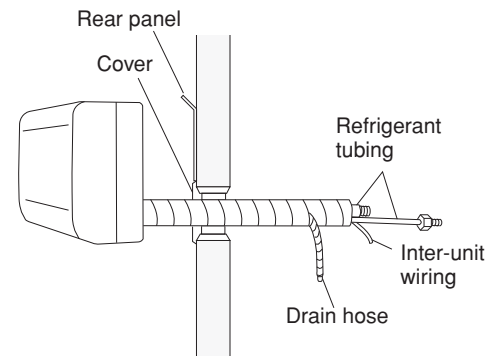

Fig. 35

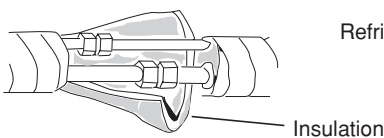

Fig. 37a

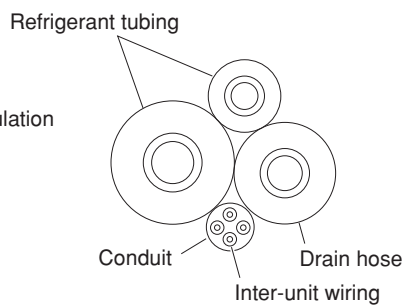

Fig. 37b

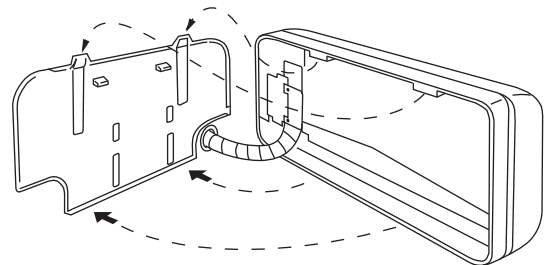

Fig. 36

■ Left-side tubing

- (1) Lead the tubing and drain hose through the wall, allowing sufficient length for connection. Then bend the tubing using a tube bender to make the attachment. (Fig. 38)
- (2) Switch the drain hose and drain cap.

Switching drain hose and drain cap

- (a) Locate the drain hose and the drain cap. (Fig. 39)
- (b) Remove the screw fastening the drain hose on the right side, and pull out the drain hose to remove it. (Fig. 39)
- (c) Apply moderate force to pull off the drain cap on the left side. (If you cannot pull it off by hand, use a long-nose pliers.)
- (d) Reattach the drain hose to the left side and the drain cap to the right side. (Fig. 40a)

Drain hose

Slide the drain hose fully onto the drain pan outlet until the drain hose edge is pushed into the insulation. Check that the screw holes in the drain bracket and the drain pan outlet are aligned and securely in contact, then fasten them with the screw. (After attaching the drain hose, check that it is attached securely.) (Fig. 40c)

Drain cap

Use a Phillips screwdriver to push the drain cap in firmly. (If it is difficult to push in, wet the cap with water first.)

- (3) Install the indoor unit on the rear panel.
- (4) Connect the tubing and wiring led inside from outdoors.
- (5) After completing a leak test, bundle the tubing together with armoring tape and store it inside the tubing storage area at the back of the indoor unit and hold it with clamps. (Figs. 40a and 41)

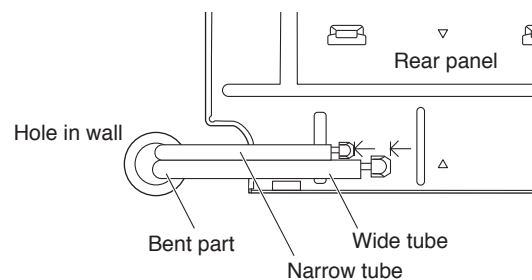

Fig. 38

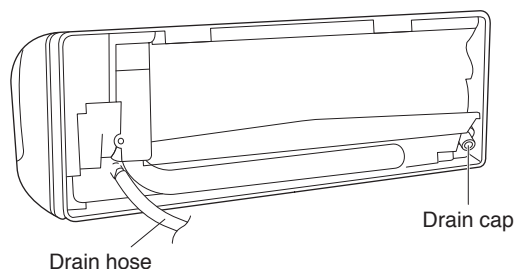

Fig. 39

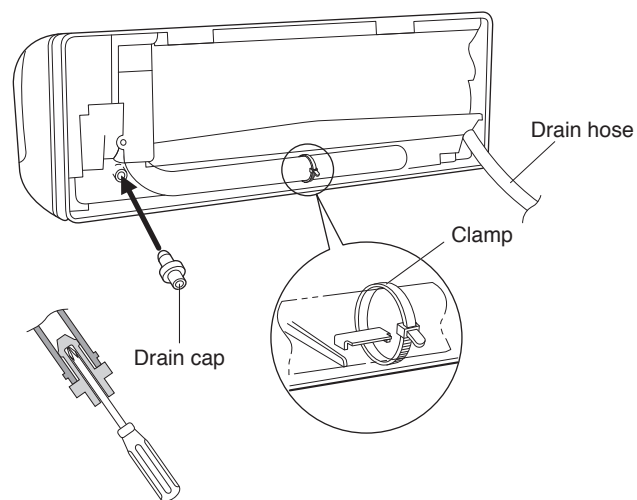

Fig. 40a

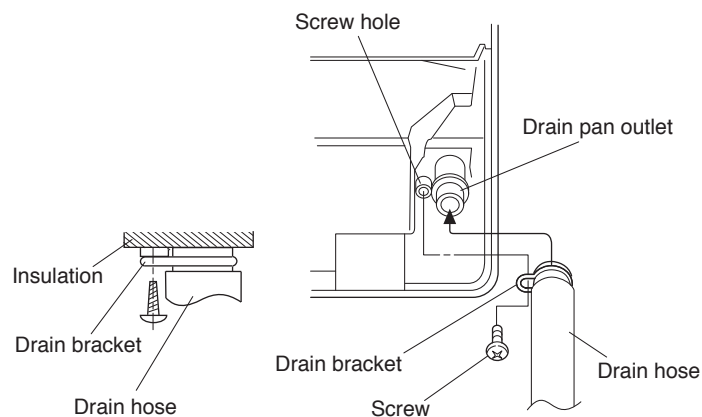

Fig. 40b

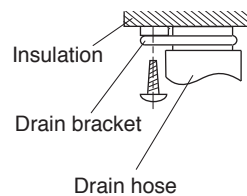

Fig. 40c

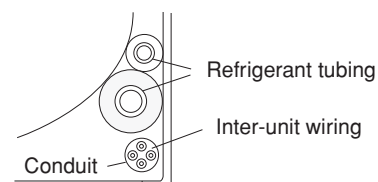

Fig. 41

To unmount indoor unit

Press the 2 \triangle marks on the lower part of the indoor unit and unlatch the tabs. Then lift the indoor unit and unmount. (Fig. 42)

3-10. Drain Hose

- The drain hose should be slanted downward to the outdoors. (Fig. 43)
- Never form a trap in the course of the hose.
- If the drain hose will run in the room, insulate the hose with insulation* so that chilled condensation will not damage furniture or floors. (Fig. 44)

* Foamed polyethylene or its equivalent is recommended.

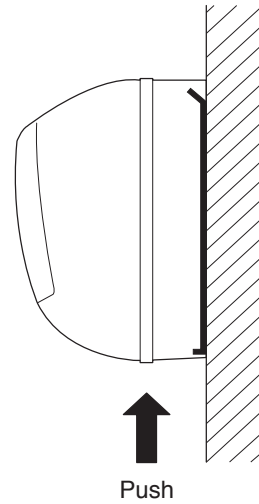

Fig. 42



WARNING

Do not supply power to the unit or operate it until all tubing and wiring to the outside unit are completed.



Risk of Electric Shock

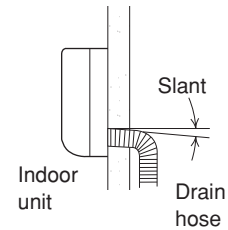

Fig. 43

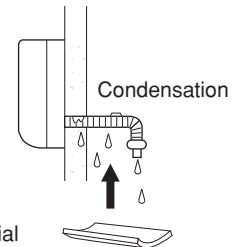

Fig. 44

4. How to Install the Outdoor Unit

First refer to Section 2. Installation Site Selection.

4-1. Wiring Instructions for the Outdoor Unit

Regulations on wire size differ from locality to locality. For field wiring requirements, please refer to your local electrical codes. Make sure that the installation fully complies with all local and national regulations.

- (1) Remove access panel "C". (Fig. 46)
- (2) Connect the inter-unit and power supply line according to the drawing on the panel side.
- (3) Be sure to size each wire allowing approx. 4" (10 cm) longer than the required length for wiring. Store excess wiring inside the cabinet.
- (4) When connections are completed, check that all connections are correct as shown in the wiring system diagram on panel side.
- (5) Be sure to ground the unit according to your local codes.

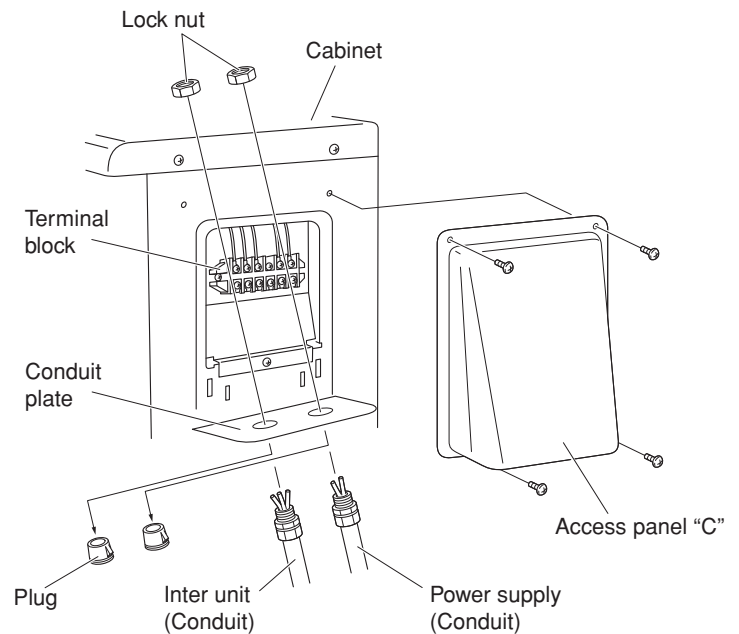

Fig. 46

5. Refrigerant Tubing

5-1. Use of the Flaring Method

Many of the conventional split system air conditioners employ the flaring method to connect refrigerant tubes which run between indoor and outdoor units. In this method, the copper tubes are flared at each end and connected with flare nuts.

5-2. Flaring Procedure with a Flare Tool

- (1) Cut the copper tube to the required length with a tube cutter. It is recommended to cut approx. 12" to 20" (30 to 50 cm) longer than the tubing length you estimate.
- (2) Remove burrs at the end of the copper tube with a tube reamer or file. This process is important and should be done carefully to make a good flare. (Fig. 47)

NOTE

When reaming, hold the tube end downward and be sure that no copper scraps fall into the tube. (Fig. 48)

- (3) Remove the flare nut from the unit and be sure to mount it on the copper tube.
- (4) Make a flare at the end of copper tube with a flare tool.* (Figs. 49a and 49b)

(*Use "RIDGID" or equivalent.)

NOTE

A good flare should have the following characteristics:

- inside surface is glossy and smooth.
- edge is smooth.
- tapered sides are of uniform length.

5-3. Caution before Connecting Tubes Tightly

- a) Be sure to apply a sealing cap or water-proof tape to prevent dust or water from getting into the tubes before they are used.
- b) Be sure to apply refrigerant lubricant to the matching surfaces of the flare and union before connecting them together. This is effective for reducing gas leaks. (Fig. 50)
- c) For proper connection, align the union tube and flare tube straight with each other, then screw in the flare nut lightly at first to obtain a smooth match. (Fig. 51)

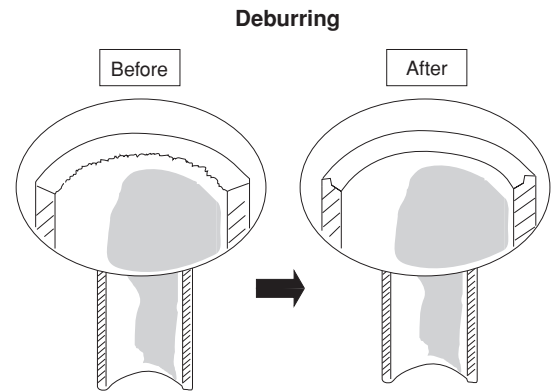

Fig. 47

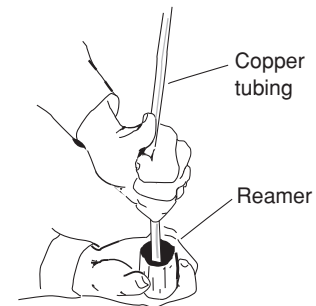
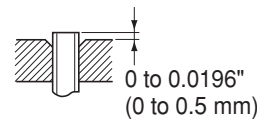
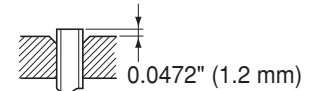

Fig. 48

If the special R410A flare tool is used:



If the previous flare tool (clutch-type) is used:



Adjust so that the amount of tube protrusion is as shown in the figure.

Fig. 49a

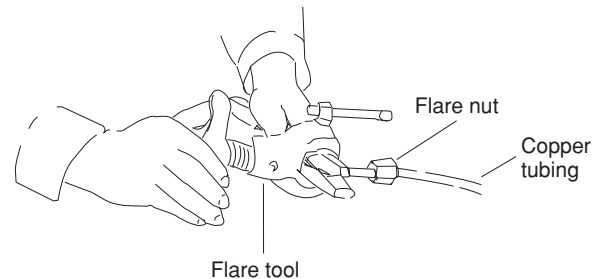

Fig. 49b

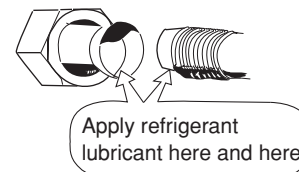

Fig. 50

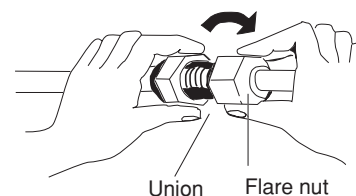

Fig. 51

5-4. Connecting Tubing between Indoor and Outdoor Units

- a) Tightly connect the indoor side refrigerant tubing extended from the wall with the outdoor side tubing. (Fig. 52)
- b) To fasten the flare nuts, apply specified torque as:

Table 6

Tube Dia.	Nut	Tightening Torque
1/4" (6.35 mm)	21/32" (17 mm)	Approx. 120 – 160 lbs·in (140 – 180 kgf·cm)
3/8" (9.52 mm)	7/8" (22 mm)	Approx. 300 – 360 lbs·in (340 – 420 kgf·cm)
1/2" (12.70 mm)	1-1/32" (26 mm)	Approx. 430 – 480 lbs·in (490 – 550 kgf·cm)
5/8" (15.88 mm)	1-5/32" (29 mm)	Approx. 590 – 710 lbs·in (680 – 820 kgf·cm)

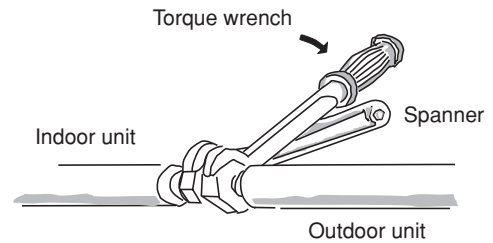

Fig. 52

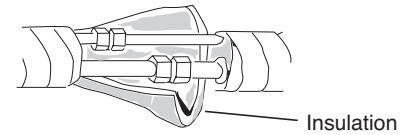

Fig. 53

5-5. Insulation of Refrigerant Tubing

IMPORTANT

To prevent heat loss and wet floors due to dripping of condensation, **both tubes must be well insulated with a proper insulation material.** (Fig. 53)

The thickness of the insulation should be a minimum 5/16" (8 mm). (Fig. 54)

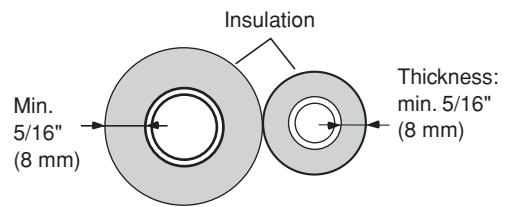

Fig. 54



CAUTION

After a tube has been insulated, never try to bend it into a narrow curve, as this may cause the tube to break or crack.

5-6. Taping the Tubes

- (1) At this time, the 2 refrigerant tubes (and electrical wire if local codes permit) should be taped together with armoring tape. The drain hose may also be included and taped together as 1 bundle with the tubing.
- (2) Wrap the armoring tape from the bottom of the outdoor unit to the top of the tubing where it enters the wall. As you wrap the tubing, overlap half of each previous tape turn. (Fig. 55)
- (3) Clamp the tubing bundle to wall, using 1 clamp approx. every 47" (120 cm).

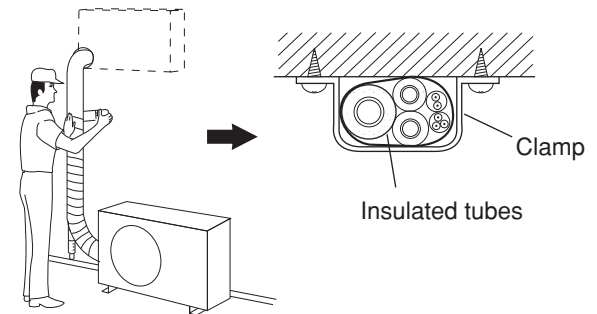

Fig. 55

NOTE

Do not wind the armoring tape too tightly, since this will decrease the heat insulation effect. Also, be sure the condensation drain hose splits away from the bundle and drips clear of the unit and the tubing.

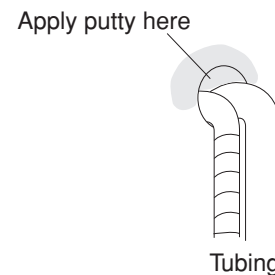

Fig. 56

5-7. Finishing the Installation

After finishing insulating and taping over the tubing, use sealing putty to seal off the hole in the wall to prevent rain and draft from entering. (Fig. 56)

6. Air Purging

Air and moisture remaining in the refrigerant system have undesirable effects as indicated below. Therefore, they must be purged completely.

- pressure in the system rises
- operating current rises
- cooling (or heating) efficiency drops
- moisture in the air may freeze and block capillary tubing
- water may lead to corrosion of parts in the refrigerant system

■ Air Purging with a Vacuum Pump (for Test Run)

- (1) Check that each tube (both narrow and wide tubes) between the indoor and outdoor units have been properly connected and all wiring for the test run has been completed. Note that both narrow and wide tube service valves on the outdoor unit are kept closed at this stage.
- (2) Using an adjustable wrench or box wrench, remove the valve caps from the service valve on both narrow and wide tubes.
- (3) Connect a vacuum pump and a manifold valve (with pressure gauges) to the service port on the wide tube service valve. (Fig. 57)



CAUTION

The service port on the wide tube service valve uses a Schrader core valve to access the refrigerant system. The valve core is similar to those used in automobile tires. Therefore, be sure to use a vacuum hose connector which has a push-pin inside.



CAUTION

Be sure to use a manifold valve for air purging. If it is not available, use a stop valve (field supply) for this purpose. The “Hi” knob of the manifold valve must always be kept closed.

- (4) With the “Lo” knob of the manifold valve open, run the vacuum pump. The operation time for the vacuum pump varies with tubing length and the capacity of the pump. The following table shows the amount of time for evacuation:

Table 7

Required time for evacuation when 100 liter/h vacuum pump is used	
If tubing length is less than 33 ft. (10 m)	If tubing length is more than 33 ft. (10 m)
10 min. or more	15 min. or more

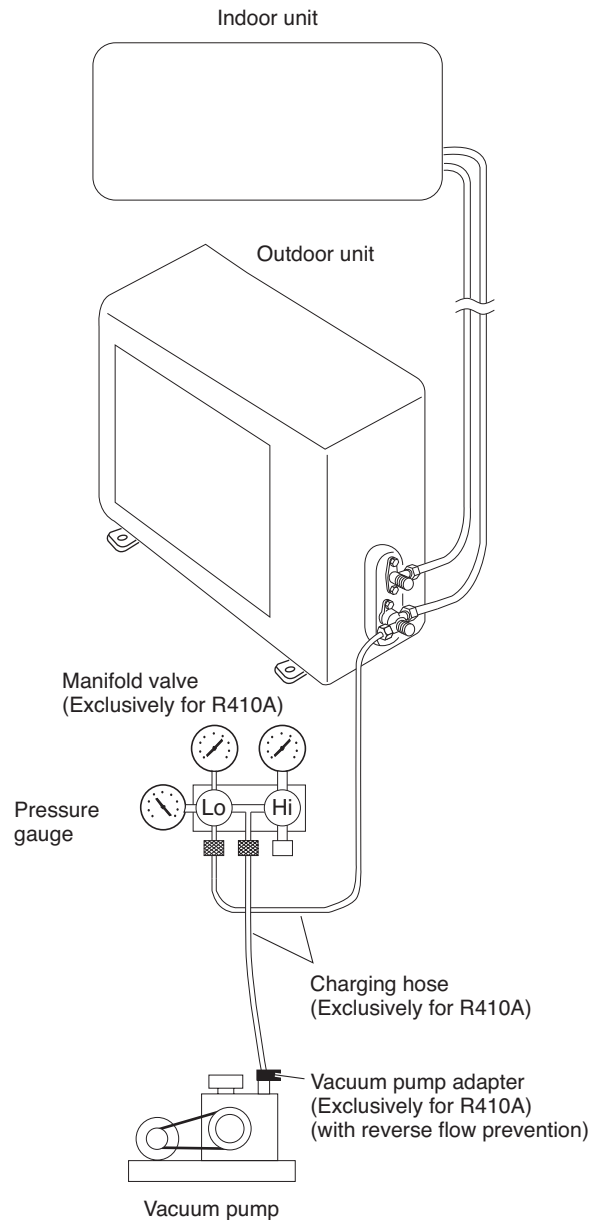

Fig. 57

NOTE

To prevent other refrigerants from being mistakenly charged to units which use R410A, the size of the charge port on the service valve is different from the one for other refrigerant types. For servicing such as recharging, the specified charging hose, manifold and vacuum pump adapter (with reverse flow prevention) for R410A must be used.

NOTE

The required time in Table 7 is calculated based on the assumption that the ideal (or target) vacuum condition is around 10 mmHg abs.

- (5) With the vacuum pump still running, close the “Lo” knob of the manifold valve. Then stop the vacuum pump.
- (6) With the hex wrench, turn the valve stem on the narrow tube service valve counter-clockwise by 90 degrees (1/4 turn) for 10 seconds, and then turn the stem clockwise to close it again. (Fig. 58)



CAUTION

Be sure to completely insert the hex wrench before attempting to turn the valve.

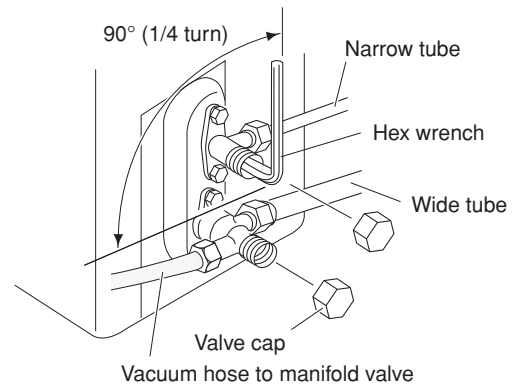

Fig. 58

- (7) Leak test all joints at the tubing (both indoor and outdoors) with soapy water. Bubbles indicate a leak. Tighten the joint more when leaks, then check if there is no leak. Be sure to wipe off the soap with a clean cloth.
- (8) With the hex wrench, turn the wide tube service valve stem counter-clockwise to fully open the valve.
- (9) Turn the narrow tube service valve stem counter-clockwise to fully open the valve.
- (10) Loosen the vacuum hose connected to the wide tube service port slightly to release the pressure. Then, remove the hose.



CAUTION

This may cause the refrigerant gas to leak. In order to avoid this, take off the hose quickly.

- (11) Fasten the valve cap on the wide tube service port securely with an adjustable wrench or box wrench. Next, mount the valve cap on the service valve and tighten it to 170 lbs-in (200 kgf·cm) with a torque wrench. This process is very important to prevent gas from leaking from the system.
- (12) Test run the air conditioner. (See next page.)
- (13) While the air conditioner is running, apply liquid soap to check for any gas leaks around the service valves or caps.
- (14) If there is no leakage, stop the air conditioner.
- (15) Wipe off the soap on the tubing.

This completes air purging with a vacuum pump and the air conditioner is ready for actual operation.

How to Test Run the Air Conditioner

After turning on the power of the air conditioner, use the remote controller and follow the steps below to conduct the test run.

- (1) Set the remote controller in Test Run mode. (Fig. 59a)
 - a) Press and hold the QUIET button and the 1HR. TIMER button.
 - b) Then press and hold the ACL (Reset) button with a pointed object such as the tip of a pen. After 5 seconds, release the ACL button first.
 - c) Then release the QUIET and 1HR. TIMER buttons.
 - d) ✱ appears and “oP-1” blinking in the remote controller clock display area. (Fig. 59b)
- (2) Start Cooling mode test run by pressing the ON/OFF operation button of the remote controller. (Fig. 59a)
 - This starts the fan producing uncooled forced air with the 3 indicator lamps (OPERATION lamp, TIMER lamp and QUIET lamp) on the main unit blinking. (Fig. 59c)
 - After 3 minutes, the system shifts into cooling operation, and cool air will start to be felt. Cooling mode test run is unaffected by the room temperature.
- (3) Press the ON/OFF operation button of the remote controller again to stop the test run. (Fig. 59a)
- (4) Finally press the ACL (Reset) button of the remote controller to release it from Test Run mode to return to normal mode. (Fig. 59a)
 - “✱” and “oP-1” will disappear from the remote controller clock display area.

NOTE

Troubleshooting:

In the event that the green “OPERATION lamp” is blinking upon powering up the system, an error condition exists. In this case, refer to the self-diagnostics procedure on the inside of the front cover.

IMPORTANT

After the test run is completed, be sure to press the ACL (Reset) button to return to normal mode. The air conditioner will not operate correctly if this is not done.

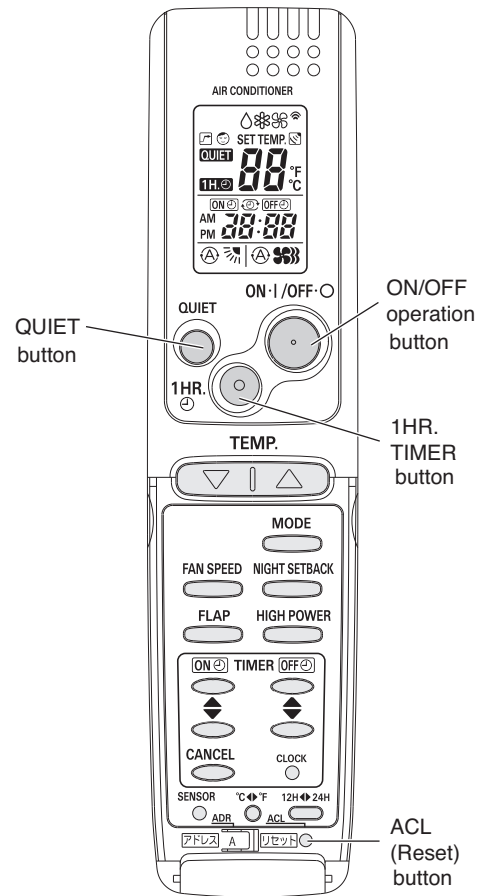

Fig. 59a

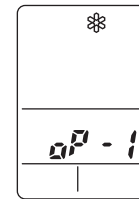

Fig. 59b

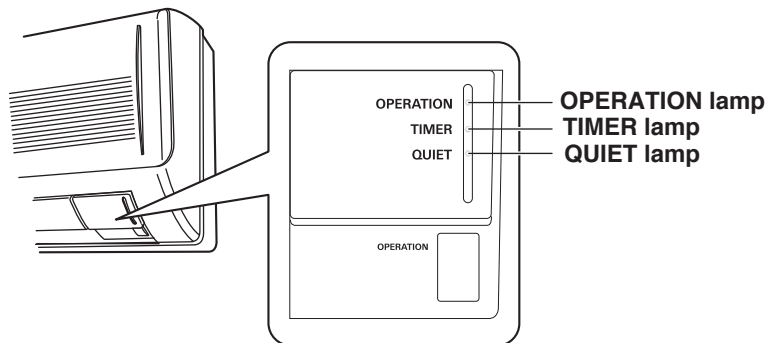
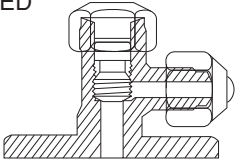
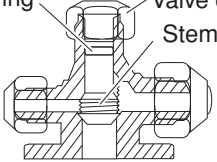
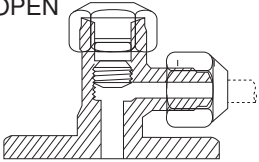
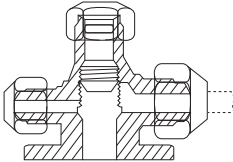
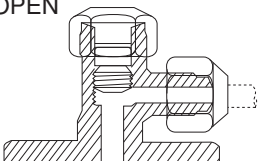
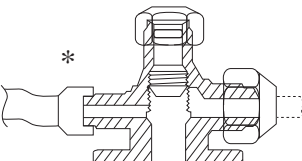
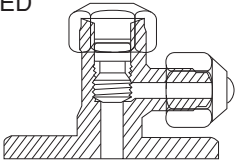
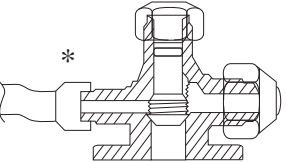

Fig. 59c

■ Basic Functions of the Service Valves

The basic functions of the service valves are given in Table 8 below.

Table 8

Action	Narrow Tube Service Valve (2-Way)	Wide Tube Service Valve (3-Way)
Shipping	CLOSED 	O-ring, Valve cap, Stem 
Operating and test running the air conditioner	Fully OPEN 	
Measuring pressure and gas charging	Fully OPEN 	* 
Air purging with a vacuum pump	CLOSED 	* 

* The service port on the wide tube service valve uses a Schrader core valve to access the refrigerant system. Therefore, be sure to use a hose connector which has a push-pin inside. (Fig. 60a)



CAUTION

When opening or closing the service valve stem, use the hex wrench. Be sure to fully seat the wrench before turning the valve.

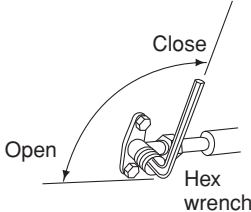
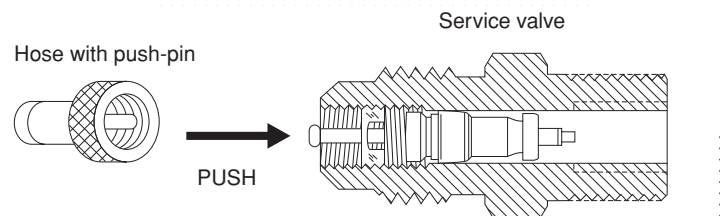

Fig. 60b



NOTE

External diameter of service port R410A: 5/16"

Fig. 60a

■ Pump Down

Pump down means collecting all refrigerant gas in the system back into the outdoor unit without losing any of the gas. Pump down is used when the unit is to be moved or before servicing the refrigerant circuit.

Pump Down Procedure

Be sure to carry out pump down with the unit in cooling mode.

(1) Connect the Lo side charging hose of the manifold valve to the service port on the wide tube service valve.

- (2) Using a hex wrench, turn the narrow tube service valve clockwise all the way to close the service valve. (Be sure to confirm that the wide tube service valve is fully open.)
- (3) Press the operation button and start cooling operation.
- (4) When the low pressure gauge reading falls to 14.2 to 7.1 psi (1 to 0.5 kg/cm²), fully close the wide tube valve stem. Then quickly stop the unit.
- (5) Disconnect all gauges and hoses, and replace the valve caps as they were before.

■ Service Valve Connections

- Temporary connection:
Screw in 3 – 5 turns by hand. (Fig. 60c)
- To fasten the flare nuts, apply specified torque as Table 9 and Fig. 60d.

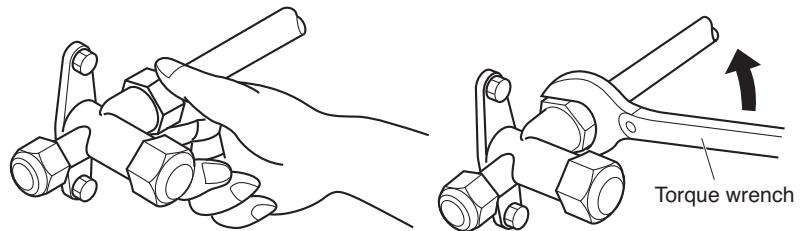

Table 9

Tube Dia.	Nut	Tightening Torque
1/4" (6.35 mm)	21/32" (17 mm)	Approx. 120 – 160 lbs·in (140 – 180 kgf·cm)
3/8" (9.52 mm)	7/8" (22 mm)	Approx. 300 – 360 lbs·in (340 – 420 kgf·cm)
1/2" (12.70 mm)	1-1/32" (26 mm)	Approx. 430 – 480 lbs·in (490 – 550 kgf·cm)
5/8" (15.88 mm)	1-5/32" (29 mm)	Approx. 590 – 710 lbs·in (680 – 820 kgf·cm)

Fig. 60c

Fig. 60d



CAUTION

Be sure to tighten the flare nut using the prescribed torque. If the nut is over-tightened, refrigerant leakage may occur.

7. Remote Controller Installation Position

The remote controller can be operated from either a non-fixed position or a wall-mounted position.

To ensure that the air conditioner operates correctly, do not install the remote controller in the following places:

- In direct sunlight
- Behind a curtain or other place where it is covered
- More than 26' (8 m) away from the air conditioner
- In the path of the air conditioner's airstream
- Where it may become extremely hot or cold
- Where it may be subject to electrical or magnetic interference
- Where there is an obstacle between the remote controller and the air conditioner (since a check signal is sent from the remote controller every 5 minutes)

7-1. Mounting on a Wall

Before mounting the remote controller, press the ON/OFF operation button at the mounting location to make sure that the air conditioner operates from that location. The indoor unit should make a beeping sound to indicate that it has received the signal.

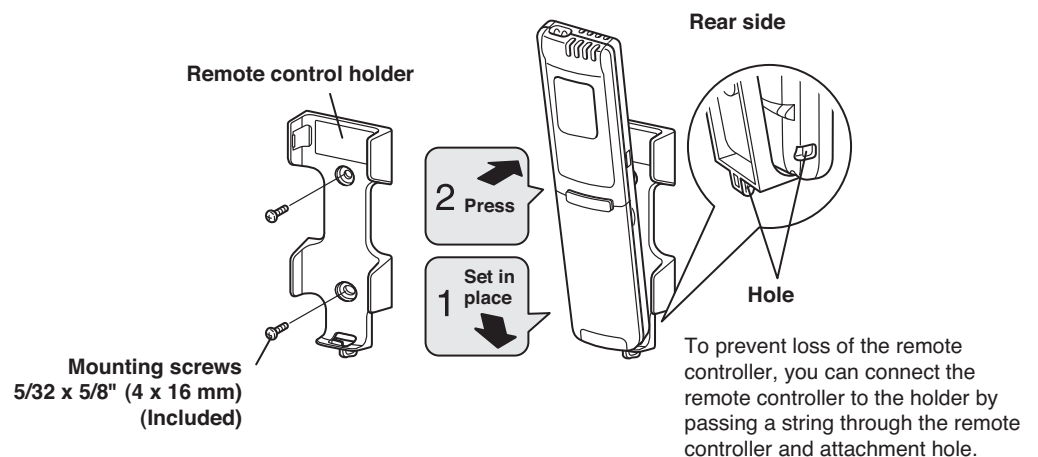

To take out the remote controller, pull it forward.

Fig. 61

8. Address Switch

8-1. Address Setting of the Remote Controller

The address can be set in order to prevent interference between remote controllers when 2 indoor units are installed near each other. The address is normally set to “A.” To set a different address, it is necessary to change the address on the second remote controller.

NOTE

Once changed, you cannot restore the original address setting of the air conditioner.

- (1) Switch on the power source.
- (2) Break the address-setting tab marked “A” on the second remote controller to change the address (Fig. 62). When the tab is removed, the address is automatically set to B (Fig. 63).
- (3) Press and hold the remote controller QUIET button and 1HR. TIMER button. Then, press and hold the ACL (Reset) button with a pointed object such as the tip of a pen. After 5 seconds, release the ACL button first, then release the QUIET and 1HR. TIMER buttons. “oP-1” (Test Run) appears, blinking in the remote controller clock display area.
- (4) Each time the 1HR. TIMER button is pressed, the display changes as shown below. Press this button 2 times to change the display to “oP-7” (Address setting). (Fig. 64)

oP-1	Test run mode
↓	
oP-3	Selfdiagnostic mode
↓	
oP-7	Address setting mode

- (5) “oP-7” has now been selected for address setting.
- (6) Press the ON/OFF operation button on the remote controller. (Fig. 64) Check that the “beep” signal-received sound is heard from the second indoor unit (approximately 5 times). The sound you hear is the signal that the remote controller address has been changed.
- (7) Finally press the remote controller ACL (Reset) button to cancel the blinking “oP-7” display. (Fig. 64)

Changing of the second remote controller address is now completed.

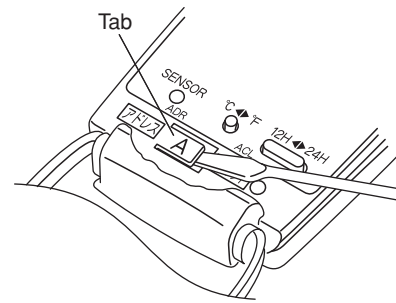

Fig. 62

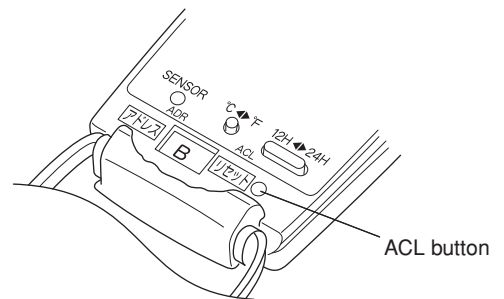

Fig. 63

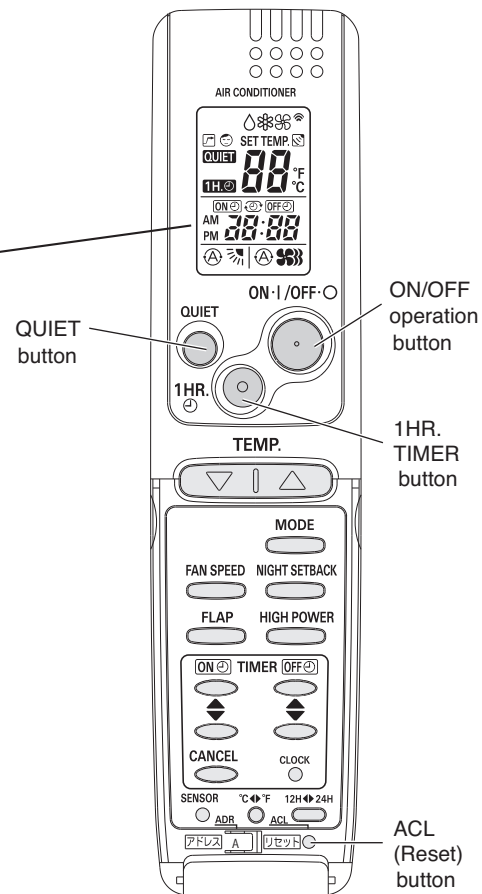

Fig. 64

