

# mellerware®

TRENDS FOR LIFE

Maestro 3-in-1 Food Processor



complies with  
INTERNATIONAL  
IEC60335  
SAFETY SPECIFICATIONS

**m**  
500 W

**CE**  
2 YEAR  
GUARANTEE

Model:  
26210

**PLEASE READ ALL INSTRUCTIONS BEFORE USE**

**2 year guarantee**

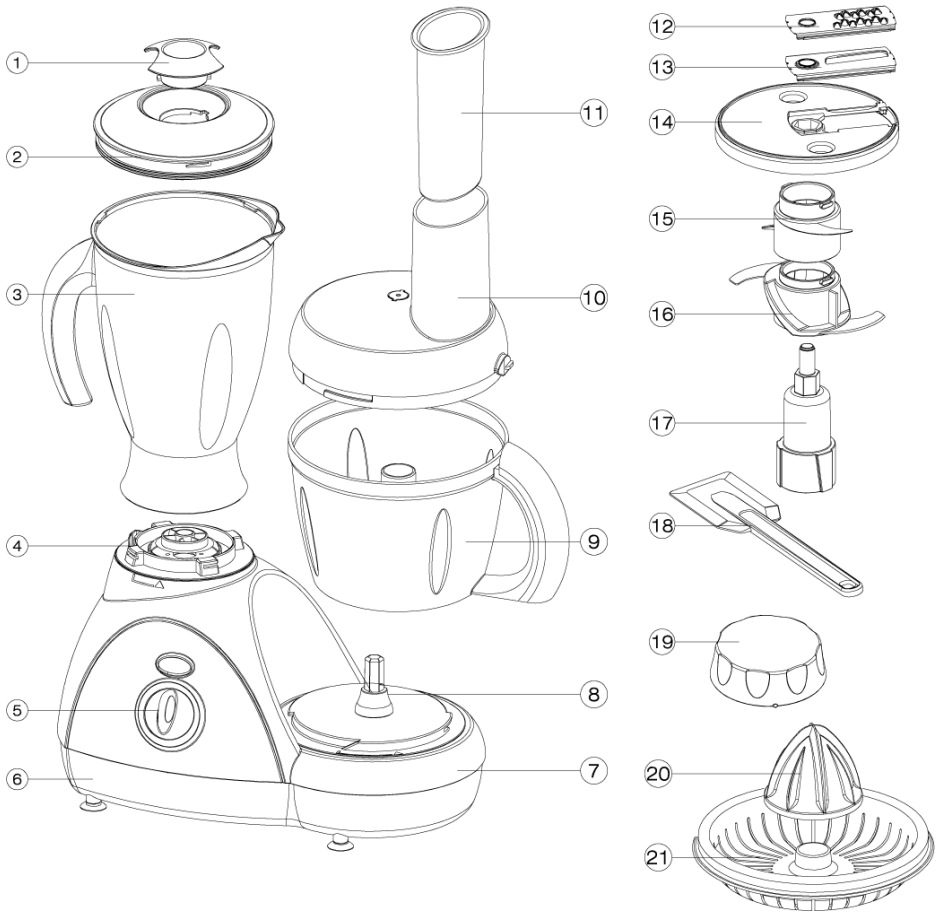

**Description**

- |                                    |                        |                     |
|------------------------------------|------------------------|---------------------|
| 1 Blender Jug Cup<br>Measuring Cup | 8 Axis Tube            | 16 Chopping Blade   |
| 2 Blender Jug cover                | 9 Mixing Bowl          | 17 Blade Support    |
| 3 Blender Jug                      | 10 Bowl Cover(Plastic) | 18 Scoop            |
| 4 Switch Connector                 | 11 Measuring Cup       | 19 Protect cover    |
| 5 Knob                             | 12 Shredding Knife     | 20 Juice Drill      |
| 6 Power Unit                       | 13 Slicing Knife       | 21 Filtrating Plate |
| 7 Switch Connector                 | 14 Knife Support       |                     |
|                                    | 15 Whisking Blade      |                     |

## IMPORTANT SAFETY INSTRUCTIONS

- Please read this handbook as it gives important instructions about safety, use and maintenance of your appliances and keep it safe for future reference.
- Do not leave parts of packaging (plastic bags, foam polystyrene, nails, etc.) within reach of children or incapable persons as they are potential sources of danger.
- Make sure the data on the appliance rating plate corresponds to that of the main power supply and of your electrical system before plugging into the outlet. In case of doubt, contact professionally qualified personnel.
- It is advisable not to use adapters, multiple plugs and extensions. Use devices certified and confirming to existing safety standards only should it be absolutely necessary, making sure they are compatible with your electrical system and with the appliance technical data.
- Noise emission level of operation is at 95dB(A).
- Any installation not conforming to instructions may endanger your safety and forfeit the guarantee.
- The appliance must be used for the purpose for which it was designed only, i.e. preparing food for domestic use.
- For safety's sake be careful:
  - not to use the appliance with bare feet or wet hands or feet
  - not to use the appliance anywhere other than domestic environment
  - not to leave the appliance exposed to atmospheric agents (sun, rain...)
  - not to allow children or incapable persons to use the appliance
  - never to tug on the lead or appliance itself to unplug from the outlet
  - not to leave the appliance plugged into the main power supply unattended
  - never to submerge the appliance in water or in other liquids.
- The user must not replace the appliance lead. Contact a professionally qualified person in case of need.
- Switch off and do not mishandle the appliance if it should breakdown and/or work badly. Contact a authorized Service Centre for eventual repairs, asking for original spares.
- Put the appliance out of service at the end or its service life by cutting off the lead after unplugging from the outlet. Abide by local existing rules and regulations for its disposal.
- Our company may not be held liable for eventual damages to persons, animals or objects caused by incorrect installation or deriving from improper, erroneous or unreasonable use.
- Do not use continuously for more than 30 seconds. Allow a rest period between operations for the same time period.

---

## BEFORE USE

- Read this handbook to familiarize yourself with all the parts of your new food processor.
- Clean all the parts and accessories in contact with food before using the appliance for the first time (see paragraph "Cleaning").

**Warning! Always take care when you are handling the blades to fit them on, taking them out of the bowl (B1) after preparing the food and when cleaning them, as they are very sharp.**

- Do not operate without the cover in place.

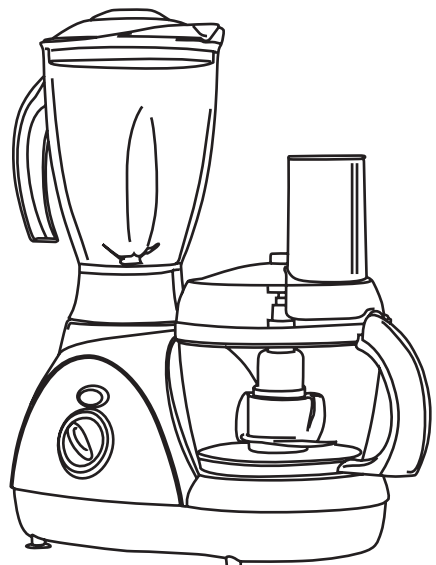

## OPERATING INSTRUCTIONS

Your new food processor will help you to prepare a lot of basic mixtures that you can use for your recipes.

Please abide by the following instructions to achieve the best results and to keep your appliance in good working condition.

**Attention! Never exceed the maximum quantities below and never pour liquids hotter than 75°C into the bowl and/or blender**

Follow the instructions given below every time you use it:

- Never leave the appliance unattended while it is on.
- Never make the appliance work while it is empty.
- Never touch the moving parts.
- Never put your fingers or utensils inside the lid opening.
- Never press down the ingredients into the lid opening with your hands.
- Do not use the appliance to work hard ingredients (e.g. frozen meat, crusts of cheese...), rubbery (e.g. candied peel...), uneatable parts of ingredients (e.g. bones., fishbones...) or crush ice.
- Do not remove the lid and never replace accessories without switching off the appliance and if the accessory being used has not stopped working.
- Do not remove the ingredients from the bowl before removing the blade

### A: Mixing Bowl

#### I. Chopping Function

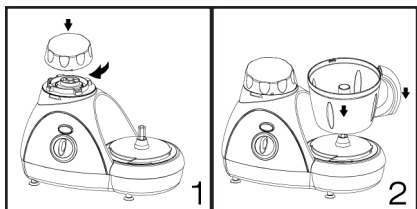

- put the protect cover onto the body tightly ,as shown in Diagram 1
- put the plastic bowl on power unit and turn the handle in clock-wise direction, as shown in Diagram 2 & 3

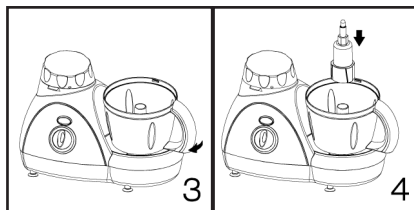

- Put the blade support on the axis in the middle of the bowl, and press it to the bottom. Then fix the chopping blade to the blade support, as shown in Diagram 4 & 5.

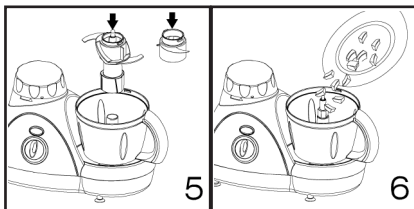

**Warning: The blade is sharp. Please only hold the plastic part while using.**

- Put the food (eg. Meet) into the bowl, as shown in Diagram 6. Big piece food needs to be cut into small pieces. ( 2 cm x 2 cm x 2 cm).
- Put the cover on the bowl, and turn it until hearing the chattering sound, as shown in Diagram 7.
- Fix the plug to the electric socket, Turn the knob to the required level, as shown in Diagram 8. (The speed is increased by levels. PULSE is the highest level . Turn the knob to the PULSE for any intermittent operation. )

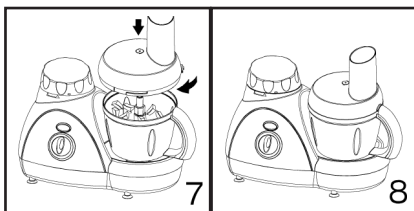

- When the chopping is finished, Turn the knob to the "0". After the blade stops, pour out the food.

#### II. Whisking Function

Mixing function has almost the same operating steps as chopping function. Only change the chopping blade to shredding blade. It is used for mixing and whisking of food, eg. egg, soup.

### III. Slicing & Shredding Function

- Put the protect cover onto the body tightly;
- Fix the slicing/shredding knife to the knife support, as shown in Diagram 9. Slicing knife makes the food into slices. Shredding knife make the food into shreds.
- Put the bowl on the power unit first, then turn the bowl in clock-wise direction, until hearing the chattering sound. Then put the knife support on the axis in the middle of the bowl, as shown in Diagram 10.

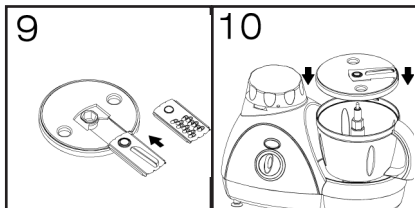

- Put the cover on the bowl, and turn it until hearing the chattering sound. Then fix the plug to the electric socket, turn the switch to choose the level. Place the strips of food through the bowl cover, and push the food down slowly, When the food strip is short, push them down with the measuring cup, as shown in Diagram 11&12.

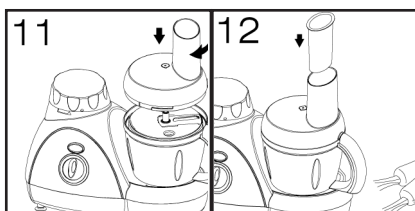

- When the operation is finished, Turn the knob to the "0". After the blade stops completely, pure out the food.

### IV. Juicing Function

- 1 Put the bowl on the power unit first, then turn the bowl in clock wise direction, until hearing the chattering sound. Then fix the filtrating plate and juice drill to the bowl, as shown in Diagram 13&14.
- 2 Fix the plug to the electric socket, turn the switch to 1
- 3 Cut the citrus fruit in half, then press the cut side slowly onto the juice drill, as shown in Diagram 15.
- 4 Pure out the juice, and mix with seasoning as you like.

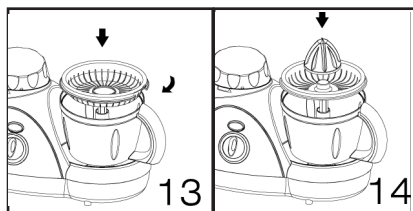

### B: Blender jug

- Put the bowl on the power unit first, Then turn the bowl in clock-wise direction, until hearing the chattering sound; Put the cover on the bowl, and turn it until hearing the chattering sound.
- Place the ingredients into the Blender jug and fix the Blender jug cover onto the body tightly

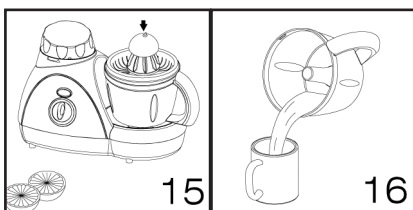

- Put Blender jug on the power unit till cup support connect with power unit properly.
- Connect the power plug of the machine and switch on the food processor. Turn the knob to the required level. The speed is increased by levels. PULSE is the highest level . Turn the knob to the PULSE for any intermittent operation.
- You can add some liquid material ( such as oil, cream if any ) to the food when mixing from material entrance if necessary;
- Turn the knob to "0" level and shut off the machine after working. Pour the mixed food out of the Blender jug.

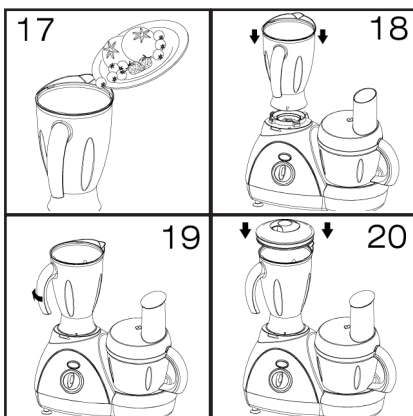

## INGREDIENTS LIST

### • BLENDER JUG

FUNCTION	INGREDIENT	MAX QTY.	MAX TIMES (s)	
			SLICING	SHREDDING
SLICING & SHREDDING	MURPHY	400g	50s	30s
	MELON	400g	50s	30s
	CARROT	400g	50s	30s
CHOPPING & WHISKING	MEAT	300g ( $\pm$ 10g/piece)	30s	
	HAM	300g ( $\pm$ 15g/piece)	30s	
	ONIONS	400g ( $\pm$ 20g/piece)	30s	
	EGG	six yolks	25s	
	STRAWBERRY	200g	25s	
	CHEESE	100g	20s	
	ALMONDS	100g	20s	
	HAZELNUTS	100g	20s	
WALNUTS	100g	20s		

## INGREDIENTS LIST

### • BOWL

MATERIAL	MAX QTY	MAX TIMES (s)
apple	250g	30s
orange	300g	30s
grape	250g	30s
strawberry	250g	30s

## CLEANING

- Always unplug from power outlet before any cleaning jobs.
  - Clean the Power Unit (6) with a soft slightly damp cloth. Do not wash it under running water and do not submerge it in water or other liquids.
  - All accessories can be washed by hand or in the dishwasher:
  - for hand washing use tepid water and normal washing up detergent, being careful of the steel blade as it is very sharp;
  - Washing in the dishwasher-place accessories in the upper part and make sure the water never exceeds maximum temperature of 50°C
- Do not use chemical or abrasive substances.

***Note! When you have finished cleaning make sure the parts controlled by the bowl safety system (motor unit at the point where the lip of the lid fits into place) and for models with blender jugs (jug housing on the motor unit, blender jug and lid), are not obstructed by solid waste. If necessary use a soft brush to clean eventual residuals with the appliance unplugged from the mains.***

- The blades cannot be sharpened. Replace them if they are not cutting properly or are worn.
- Contact an authorized Service Centre to purchase accessories, parts liable to wear and for maintenance work on your appliance.

## STORAGE

- Make sure your appliance and all its accessories are completely dry before putting them away.
- Your food processor has a space-saving storage system where all accessories can be put away tidily in the bowl..

***Attention! To avoid damages never use the appliance with accessories still inside.***

creative housewares

27 Nourse Avenue Epping 2 Cape Town  
PO. Box 975 Eppindust 7475 South Africa  
Tel: +27 21 534 8114 Fax: +27 21 534 8086  
Service Centre Share Call: 086 111 5006  
web: [www.creativehousewares.co.za](http://www.creativehousewares.co.za)