

Grizzly *Industrial, Inc.*®

MODEL H5977

FLOORING STAPLER

INSTRUCTION MANUAL



COPYRIGHT © MARCH, 2004 BY GRIZZLY INDUSTRIAL, INC., REVISED DECEMBER, 2009 (TS)

**WARNING: NO PORTION OF THIS MANUAL MAY BE REPRODUCED IN ANY SHAPE
OR FORM WITHOUT THE WRITTEN APPROVAL OF GRIZZLY INDUSTRIAL, INC.
(FOR STAPLERS MANUFACTURED SINCE 2/07) #TR6136 PRINTED IN CHINA**

SAFETY

WARNING

For Your Own Safety Read Instruction Manual Before Operating This Equipment

The purpose of safety symbols is to attract your attention to possible hazardous conditions. This manual uses a series of symbols and signal words which are intended to convey the level of importance of the safety messages. The progression of symbols is described below. Remember that safety messages by themselves do not eliminate danger and are not a substitute for proper accident prevention measures.

DANGER

Indicates an imminently hazardous situation which, if not avoided, WILL result in death or serious injury.

WARNING

Indicates a potentially hazardous situation which, if not avoided, COULD result in death or serious injury.

CAUTION

Indicates a potentially hazardous situation which, if not avoided, MAY result in minor or moderate injury. It may also be used to alert against unsafe practices.

NOTICE

This symbol is used to alert the user to useful information about proper operation of the equipment.

WARNING

Safety Instructions For Pneumatic Tools

- KEEP ALL SAFETY DEVICES IN PLACE** and in working order.
- REMOVE ADJUSTING KEYS AND WRENCHES.** Form habit of checking to see that keys and adjusting wrenches are removed from tool before operation.
- KEEP WORK AREA CLEAN.** Cluttered areas and benches invite accidents.
- DO NOT USE IN DANGEROUS ENVIRONMENT.** DO NOT use pneumatic tools in damp or wet locations, or where any flammable or noxious fumes may exist. Keep work area well lighted.
- KEEP CHILDREN AND VISITORS AWAY.** All children and visitors should be kept at a safe distance from work area.
- MAKE WORKSHOP CHILD PROOF** with padlocks, master switches, or by removing air hoses from tools.
- DO NOT FORCE TOOL.** It will do the job better and safer at the rate for which it was designed.
- USE THE RIGHT TOOL.** DO NOT force tool or attachment to do a job for which it was not designed.
- DO NOT USE UNDER THE INFLUENCE OF DRUGS OR ALCOHOL.**

WARNING

Safety Instructions For Pneumatic Tools

10. **USE PROPER AIR HOSE** for the tool. Make sure your air hose is in good condition and is long enough to reach your work without stretching.
11. **WEAR PROPER APPAREL.** DO NOT wear loose clothing, gloves, neckties, rings, bracelets, or other jewelry which may get caught in moving parts. Non-slip footwear is recommended. Wear a protective hair covering to contain long hair.
12. **ALWAYS USE SAFETY GLASSES.** Everyday eyeglasses only have impact resistant lenses, they are NOT safety glasses.
13. **ALWAYS WEAR RESPIRATOR OR DUST MASK** when grinding, sanding, blowing compressed air, or any other activity that causes or stirs up dust.
14. **WEAR APPROVED HEARING PROTECTION.**
15. **SECURE WORK.** Use clamps or a vise to hold work when practical. It is safer than using your hand and frees both hands to operate tool.
16. **DO NOT OVERREACH.** Keep proper footing and balance at all times.
17. **MAINTAIN TOOLS WITH CARE.** Keep tools lubricated and clean for best and safest performance. Follow instructions for lubricating and changing accessories.
18. **REDUCE THE RISK OF UNINTENTIONAL STARTING/ FIRING.** DO NOT carry tool with hand on trigger and always disconnect the air hose when not in use.
19. **DISCONNECT TOOLS** before servicing and changing accessories.
20. **USE THE RECOMMENDED ACCESSORIES.** Consult the owner's manual for recommended accessories. The use of improper accessories may increase the risk of injury.
21. **CHECK DAMAGED PARTS.** Before further use of the tool, a guard or other part that is damaged should be carefully checked to determine if it will operate properly and perform its intended function. Check for alignment of moving parts, binding of moving parts, breakage of parts, mounting, and any other conditions that may affect its operation. Replace/repair any parts that may affect the proper operation of the tool.
22. **NEVER LEAVE UNATTENDED TOOL CONNECTED TO AIR.** Disconnect the air hose and DO NOT leave tool unattended until it is relieved of any built up pressure.
23. **NEVER ALLOW UNTRAINED USERS TO USE THIS TOOL WHILE UNSUPERVISED.**
24. **IF YOU ARE UNSURE OF THE INTENDED OPERATION, STOP USING THE TOOL.** Seek formal training or research books or magazines that specialize in pneumatic tools.

⚠ WARNING

Basic Stapler Safety

In addition to the rules stated in the previous section, and those in the warning boxes throughout this manual, please observe the following safety tips for your new stapler:

- 1. READ THIS ENTIRE MANUAL BEFORE OPERATING THE STAPLER.**
- 2. ALWAYS DISCONNECT AIR FROM THE STAPLER WHENEVER SERVICING OR INSTALLING STAPLES.** During maintenance, a stapler connected to air may fire accidentally, causing serious personal injury.
- 3. DO NOT PLACE HANDS NEAR STAPLE POINT OF ENTRY.** Staple can deflect and tear through the surface of the workpiece, puncturing your hand or fingers.
- 4. NEVER CONNECT THE STAPLER TO PRESSURIZED OXYGEN OR OTHER COMBUSTIBLE GASES AS A POWER SOURCE.** Only use filtered, lubricated, and regulated compressed air.
- 5. NEVER USE GASOLINE OR OTHER FLAMMABLE LIQUIDS TO CLEAN THE STAPLER.** Vapors in the tool will ignite by a spark and cause the tool to explode.
- 6. ONLY CARRY STAPLER BY THE HANDLE,** carrying the stapler by the air hose, nose, whack cap, magazine etc. may cause it to accidentally fire in an uncontrolled direction.
- 7. BE CAREFUL NOT TO BUMP THE ACTUATING MECHANISM WHEN CARRYING OR HOLDING THE TOOL WHILE CONNECTED TO AIR.** If bumped, the tool may accidentally shoot in a dangerous direction.

⚠ WARNING

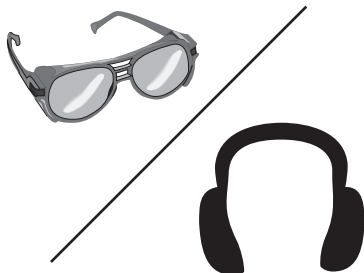

Operating this stapler can propel objects into the air, causing immediate eye damage. To protect yourself, always wear American National Standards Institute (ANSI) approved safety glasses or goggles when operating this equipment. In addition, this stapler discharges at 85-90 decibels. To protect your hearing, always wear ANSI approved ear protection when operating this stapler.

⚠ WARNING



Staples shot from this stapler could cause severe injury to yourself or another person. Always point this stapler away from people in the event that it accidentally shoots, and use this tool with respect and caution to reduce the possibility of operator or bystander injury.

INTRODUCTION

Commentary

We are proud to offer the Grizzly Model H5977 Flooring Stapler. This model is part of a growing Grizzly family of fine tools. When used according to the guidelines set forth in this manual, you can expect years of trouble-free, enjoyable operation and proof of Grizzly's commitment to customer satisfaction.

We are pleased to provide this manual with the Model H5977. It was written to encourage safety considerations and guide you through general operating procedures and maintenance. This manual represents our effort to produce the best documentation possible.

The specifications, details, and photographs in this manual represent the Model H5977 as supplied when the manual was prepared. However, owing to Grizzly's policy of continuous improvement, changes may be made at any time with no obligation on the part of Grizzly. If you have any comments regarding this manual, please write to us at the address below:

Grizzly Industrial, Inc.
% Technical Documentation
P.O. Box 2069
Bellingham, WA 98227-2069

Most importantly, we stand behind our tools. If you have any service questions or parts requests, please call or write us at the location listed below.

Grizzly Industrial, Inc.
1203 Lycoming Mall Circle
Muncy, PA 17756
Phone: (570) 546-9663
Fax: (800) 438-5901

E-Mail: techsupport@grizzly.com
Web Site: <http://www.grizzly.com>



WARNING

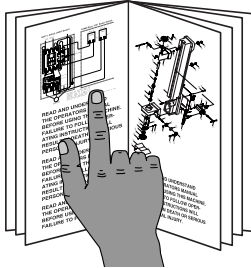

Read the manual before assembly and operation. Become familiar with this tool, its safety instructions, and its operation before beginning any work. Serious personal injury may result if safety or operational information is not understood or followed.

Compressed Air System

The Model H5977 is designed to be operated at 60-100 psi. The maximum permissible operating pressure for this stapler is 100 psi. **DO NOT exceed 120 psi!**

Before using, install a male quick connect fitting on the stapler. Regulate the air pressure on your air compressor to 80 psi.

This stapler will benefit from an in-line filter/lubricator/regulator unit. Using this unit protects your tool from damaging water build-up, allows you to adjust and maintain constant air pressure to your tool, and automatically lubricates your tool every time you use it. Check the current Grizzly catalog for availability of this unit. If you plan on installing a filter/lubricator/regulator unit in your compressed air system, always follow the connection instructions that come with the unit.



Exceeding the maximum permissible operating pressure may cause the stapler to explode, blowing metal fragments in all directions. To protect yourself from serious personal injury, DO NOT allow your air compressor to exceed the recommended pressure when connected to this stapler!

Firing Mechanism

When the firing mechanism is working properly, the stapler does not fire when immediately connected to the air supply.

This stapler is equipped with a "whack cap," which when hit with the mallet will fire the stapler.

Before you load your stapler for the first time, check the firing mechanism to ensure safe use.

To check the firing mechanism:

1. **Make sure the stapler is disconnected from the air supply!**
2. Make sure the magazine is empty and contains no staples.
3. Connect the stapler to the air supply. The stapler should not fire.
 - If it **does not** fire, read **step 4**.
 - If the stapler **does** fire, immediately disconnect the stapler from the air supply and call (570) 546-9663 for technical support.
4. Place the base of the stapler on a scrap piece of wood that is clean and free of any knots, staples, or other foreign objects.
5. Hit the whack cap with the mallet using moderate force. The stapler should fire.
 - If it **does** fire, then the firing mechanism is working properly. Continue to the next section.
 - If the **does not** fire, then the firing mechanism may not be working correctly or may need service. Please call (570) 546-9663 for technical support.

NOTICE

Continually firing the stapler when empty will cause internal damage. Only fire the empty stapler once or twice to ensure it is functioning properly.

OPERATION

Oiling Stapler

Place one or two drops of pneumatic tool oil in the stapler air inlet (as shown in **Figure 1**) before every use. Wipe off any excess oil near the stapler exhaust to avoid dust build-up.

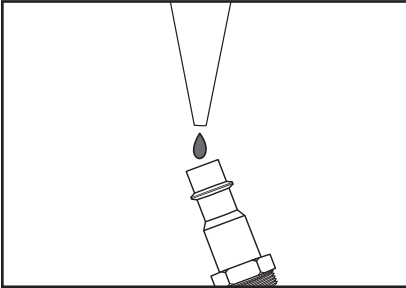

Figure 1. Lubricating stapler via air inlet.

Another option to manual oiling would be to install a lubricator in your air compressor line. If your air compressor line already has a lubricator, then regular lubrication of your stapler will not be necessary. Just make sure there is always pneumatic tool oil in the lubricator.

As mentioned before, the best option is to install a filter/lubricator/regulator unit such as those found in the Grizzly catalog.

Loading Stapler

When replacing staples in your Model H5977, follow these guidelines:

Gauge: 15½
Staple Sizes: 1"-2"
Capacity: 60

To load your stapler:

1. **Disconnect the air supply from the stapler!**
2. Slide back the magazine loading handle until it locks.
3. Load a staple stick in the T-slot at the top of the magazine as shown in **Figure 2**.
4. Release the magazine loading handle by pulling it back, then letting go.

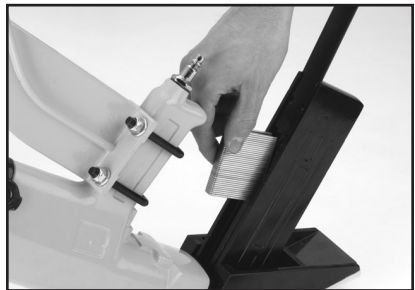

Figure 2. Loading staples into stapler.

Operating Stapler

If you have not read the safety instructions in this manual, DO NOT operate the stapler.

Before you operate your stapler, place one drop of pneumatic tool oil into the quick connect fitting where the stapler connects to the air supply.

The Model H5977 comes with two base plates of different thicknesses. The thinnest base plate is for use with $\frac{3}{4}$ " flooring, and the thickest base plate is for use with $\frac{1}{2}$ " flooring.

To operate your stapler:

1. Install the correct base plate for your size of flooring material.
2. Connect the air supply to the quick connect fitting.
3. Place the stapler on the pre-positioned flooring as shown in **Figure 3**, making sure the cleat on the bottom of the stapler is lined up with the edge of the groove in the flooring.



Figure 3. Operating stapler.

4. Using the included mallet, hit the whack cap with light/medium force to shoot a staple into the wood.
5. Check the staple for proper depth and placement.
 - If the depth is satisfactory, then proceed with your project.
 - If the depth is **too shallow**, then slightly **increase** the air pressure and repeat **steps 3–5**.
 - If the depth is **too deep**, then slightly **decrease** the air pressure and repeat **steps 3–5**.

Clearing Jammed Staples

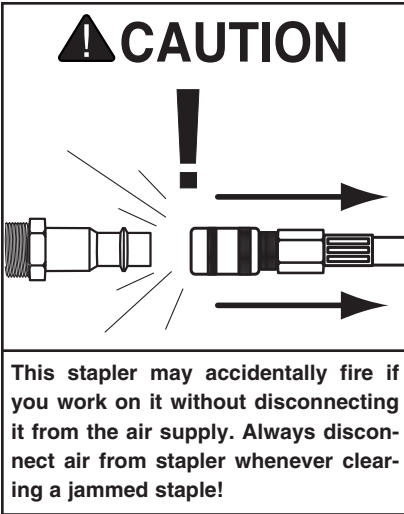

To clear a jammed staple from the discharge area on the Model H5977:

1. **Disconnect the stapler from the air supply!**
2. Pull the magazine loader all the way back and remove the staple stick.
3. The jammed staple should now be visible; remove it from the discharge area with needle nose pliers.

Cleaning Stapler

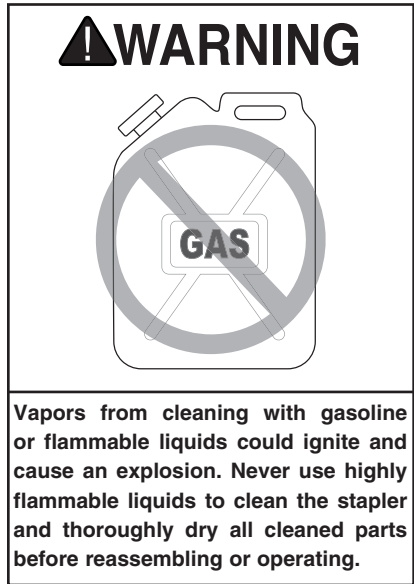

Use a good solvent to clean the nose assembly of the stapler. Always be sure that the stapler is dry before using it again.

Do not allow dust, chips, sand, etc. into the air connectors or into the body of the stapler; this may result in leaks and damage to the stapler and the air couplings.

Notes

H5977 PART BREAKDOWN

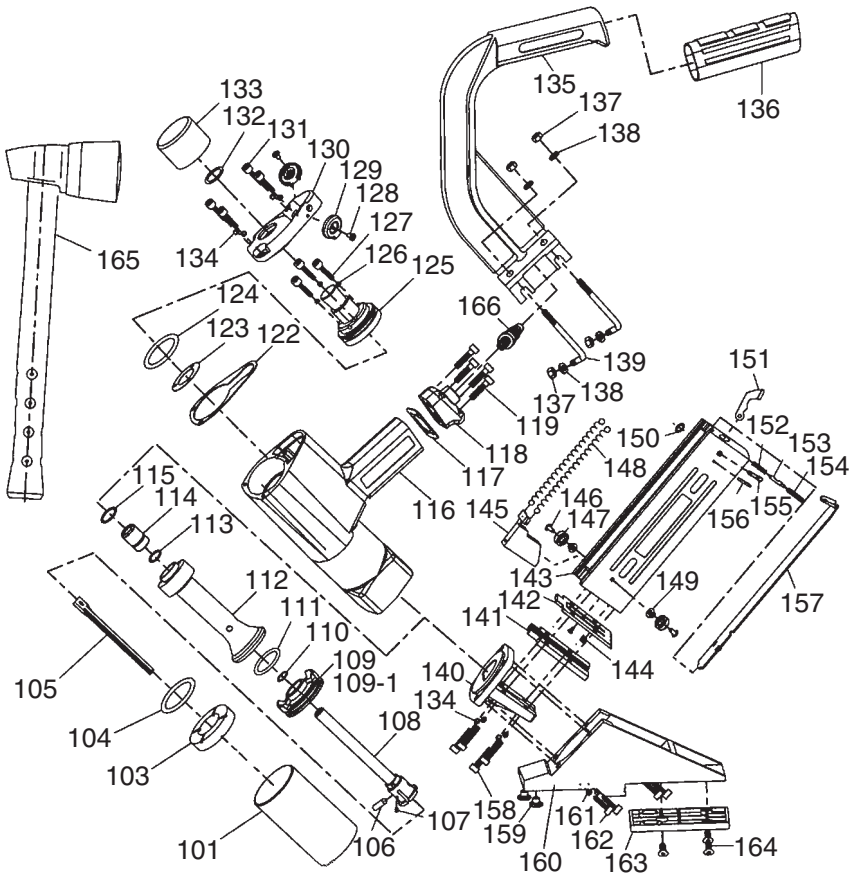

REF	PART #	DESCRIPTION
101	PH5977101	CYLINDER
103	PH5977103	BUMPER
104	PORP050	O-RING 49.7 X 3.5 P50
105	PH5977105	DRIVER
106	PRP07M	ROLL PIN 6 X 20
107	PSS31M	SET SCREW M5-.8 X 8
108	PH5977108	PISTON POLE
109	PH5977109	PISTON CAP
110	PORP012-5	O-RING 12.3 X 2.4 P12.5
111	PH5977111	O-RING 32 X 4.5
112	PH5977112	SEALING SLEEVE
113	PH5977113	O-RING 12.8 X 1.8
114	PH5977114	SEALING CAP
115	PH7826115	O-RING 15.6 X 1.8
116	PH5977116	GUN BODY
117	PH5977117	HANDLE GASKET
118	PH5977118	END CAP
119	PCAP39M	CAP SCREW M4-.7 X 20
122	PH5977122	CYLINDER GASKET
123	PH5977123	SLEEVE GASKET
124	PORP046	O-RING 45.7 X 3.5 P46
125	PH5977125	PISTON SEAT
126	PLW02M	LOCK WASHER 4MM
127	PCAP16M	CAP SCREW M4-.7 X 16
128	PS56M	PHLP HD SCR M4-.7 X 16
129	PH5977129	EXHAUST COVER
130	PH5977130	CYLINDER COVER
131	PCAP09M	CAP SCREW M5-.8 X 17
132	PORP025	O-RING 24.7 X 3.5 P25
133	PH5977133	WHACK CAP
134	PW02M	FLAT WASHER 5MM
135	PH5977135	HANDLE

REF	PART #	DESCRIPTION
136	PH5977136	HANDLE GRIP
137	PLN04M	LOCK NUT M8-1.25
138	PW01M	FLAT WASHER 8MM
139	PH5977139	L-BOLT
140	PH5977140	CYLINDER HEAD SEAT
141	PH5977141	NAIL GUIDE COVER
142	PH5977142	NAIL GUIDE
143	PH5977143	DRIVER GUIDE
144	PH5977144	NAIL GUIDE SCREW
145	PH5977145	LOADER
146	PH5977146	RIVET 4 X 8
147	PH5977147	IDLER WHEEL
148	PH5977148	LOADING SPRING
149	PH5977149	KEEPER
150	PORS003	O-RING 2.5 X 1.5 S3
151	PH5977151	SPRING LEVER
152	PH5977152	SPRING
153	PH5977153	SPRING PIN
154	PH5977154	STUD M8-1.25 X 10
155	PH5977155	MAGAZINE PIN
156	PRP05M	ROLL PIN 5 X 30
157	PH5977157	LOADING HANDLE
158	PCAP95M	CAP SCREW M5-.8 X 30
159	PH5977159	RUBBER BUTTON
160	PH5977160	BASE
161	PH5977161	WASHER
162	PCAP29M	CAP SCREW M6-1 X 40
163	PH5977163	BASE PLATE 1/2 IN. FLOORING
164	PFH02M	FLAT HD SCR M6-1 X 12
165	PH5977165	MALLET
166	PH5977166	AIR PLUG 1/4 NPT

TROUBLESHOOTING

PROBLEM	CAUSE	ACTION
Air leaking from stapler body assembly joint.	<ol style="list-style-type: none"> 1. Fasteners loose. 2. Worn/damaged o-rings or gaskets. 	<ol style="list-style-type: none"> 1. Tighten. 2. Replace.
Air leaking between housing and hose.	<ol style="list-style-type: none"> 1. Loose air fitting. 2. Loose screws in housing. 3. Damaged O-ring. 	<ol style="list-style-type: none"> 1. Tighten air fitting. 2. Tighten screws. 3. Replace O-ring.
Tool skips staples while discharging.	<ol style="list-style-type: none"> 1. Air leaks. 2. Dirt in nose. 3. Dirt or damage prevents staples from moving freely in magazine. 4. Inadequate air flow to tool. 5. Worn O-ring on piston or lack of lubrication. 6. Damaged O-rings on trigger valve. 7. Worn bumper. 8. Cap seal leaking. 	<ol style="list-style-type: none"> 1. Tighten screws and fittings. 2. Clean nose. 3. Clean magazine and inspect/repair damage. 4. Check fitting, hose, compressor & air pressure. 5. Replace piston O-ring. Lubricate. 6. Replace trigger valve O-rings. 7. Replace bumper. 8. Replace cap seal.
Tool fires slowly or has a loss of power.	<ol style="list-style-type: none"> 1. Air pressure low 2. Stapler is not sufficiently lubricated. 3. Broken spring in cap assembly. 4. Exhaust port blocked. 5. Buildup on nose/driver assy. 	<ol style="list-style-type: none"> 1. Increase pressure. 2. Lubricate stapler. 3. Replace spring. 4. Clean or replace damaged internal parts. 5. Clean.
Fasteners frequently jam the stapler.	<ol style="list-style-type: none"> 1. Staples are the wrong size. 2. Staples are wrong angle. 3. Staples are bent/damaged. 4. Magazine or nose screws are loose. 5. Driver or driver guide is worn or damaged. 	<ol style="list-style-type: none"> 1. Use correct staples. 2. Use correct angle. 3. Use undamaged staples. 4. Tighten magazine and nose screws. 5. Replace worn or damaged parts.
Stapler does not fire.	<ol style="list-style-type: none"> 1. Air pressure too low. 2. Staple is jammed in magazine or discharge area. 3. Piston shaft is damaged. 4. Stuck head valve 	<ol style="list-style-type: none"> 1. Increase air pressure. 2. Clear stapler magazine or discharge area. 3. Replace piston shaft. 4. Disassemble and lubricate.

WARRANTY AND RETURNS

Grizzly Industrial, Inc. warrants every product it sells for a period of **1 year** to the original purchaser from the date of purchase. This warranty does not apply to defects due directly or indirectly to misuse, abuse, negligence, accidents, repairs or alterations or lack of maintenance. This is Grizzly's sole written warranty and any and all warranties that may be implied by law, including any merchantability or fitness, for any particular purpose, are hereby limited to the duration of this written warranty. We do not warrant or represent that the merchandise complies with the provisions of any law or acts unless the manufacturer so warrants. In no event shall Grizzly's liability under this warranty exceed the purchase price paid for the product and any legal actions brought against Grizzly shall be tried in the State of Washington, County of Whatcom.

We shall in no event be liable for death, injuries to persons or property or for incidental, contingent, special, or consequential damages arising from the use of our products.

To take advantage of this warranty, contact us by mail or phone and give us all the details. We will then issue you a "Return Number," which must be clearly posted on the outside as well as the inside of the carton. We will not accept any item back without this number. Proof of purchase must accompany the merchandise.

The manufacturers reserve the right to change specifications at any time because they constantly strive to achieve better quality equipment. We make every effort to ensure that our products meet high quality and durability standards and we hope you never need to use this warranty.

Please feel free to write or call us if you have any questions about the machine or the manual.

Grizzly Industrial, Inc.
1203 Lycoming Mall Circle
Muncy, PA 17756
Phone: (570) 546-9663
Fax: (800) 438-5901

E-Mail:
techsupport@grizzly.com

Web Site: <http://www.grizzly.com>

Thank you again for your business and continued support. We hope to serve you again soon!

WARRANTY CARD

Name _____
Street _____
City _____ State _____ Zip _____
Phone Number _____ E-Mail _____ FAX _____
Model # _____ Serial# _____ Order # _____

The following information is given on a voluntary basis. It will be used for marketing purposes to help us develop better products and services. Of course, all information is strictly confidential.

- How did you learn about us?
 Advertisement Friend
 Catalog Card Deck
 World Wide Web
 Other _____
- What is your annual household income?
 \$20,000-\$29,999 \$60,000-\$69,999
 \$30,000-\$39,999 \$70,000-\$79,999
 \$40,000-\$49,999 \$80,000-\$89,999
 \$50,000-\$59,999 \$90,000 +
- What is your age group?
 20-29 50-59
 30-39 60-69
 40-49 70 +
- How long have you been a woodworker?
 0 - 2 Years 8 - 20 Years
 2 - 8 Years 20+ Years
- How would you rank your woodworking skills?
 Simple Advanced
 Intermediate Master Craftsman
- What stationary woodworking tools do you own?
Check all that apply.
 Air Compressor Panel Saw
 Band Saw Planer
 Drill Press Power Feeder
 Drum Sander Radial Arm Saw
 Dust Collector Shaper
 Spindle Sander Jointer _ _ _
Table Saw Lathe
 Mortiser Wide Belt Sander
 Horiz.Boring Machine
 Vacuum Veneer Press
 Other _____
- How many of your woodworking machines are Grizzly? _____
- Which benchtop tools do you own? Check all that apply.
 1"x42" Belt Sander 6" - 8" Grinder
 5" - 8" Drill Press Mini Lathe
 8" Table Saw 8" - 10" Bandsaw
 Scroll Saw Disc/Belt Sander
 Spindle/Belt Sander Mini Jointer
 10"-12" Thickness Planer Other _____

- How many of the machines checked above are Grizzly? _____
- Which portable/hand held power tools do you own?
Check all that apply.
 Belt Sander Orbital Sander
 Biscuit Joiner Palm Sander
 Circular Saw Portable Planer
 Detail Sander Saber Saw
 Drill/Driver Reciprocating Saw
 Miter Saw Router _ _ _
Other _____
- What machines/supplies would you like Grizzly Industrial to carry?

- What new accessories would you like Grizzly Industrial to carry?

- What other companies do you purchase your tools and supplies from? _____

- Do you think your purchase represents good value?
 Yes No
- Would you recommend Grizzly to a friend?
 Yes No
- Would you allow us to use your name as a reference for Grizzly customers in your area? **Note: We never use names more than three times.**
 Yes No
- Comments: _____

Send a Grizzly Catalog to a friend:

Name _____
Street _____
City _____ State _____ Zip _____

FOLD ALONG DOTTED LINE

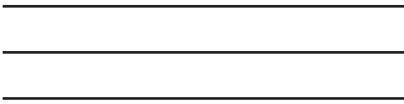

Place
Stamp
Here



GRIZZLY INDUSTRIAL, INC.
P.O. BOX 2069
BELLINGHAM, WA 98227-2069



TAPE ALONG EDGES--PLEASE DO NOT STAPLE