

TECHNICAL & SERVICE MANUAL

CS-KE30NKU + CU-KE30NKU
CS-KE36NKU + CU-KE36NKU

DC INVERTER SPLIT SYSTEM AIR CONDITIONER

Indoor Model No.	Product Code No.
CS-KE30NKU	1 852 360 88
CS-KE36NKU	1 852 360 89

Outdoor Model No.	Product Code No.
CU-KE30NKU	1 852 360 82
CU-KE36NKU	1 852 360 83

Indoor Unit

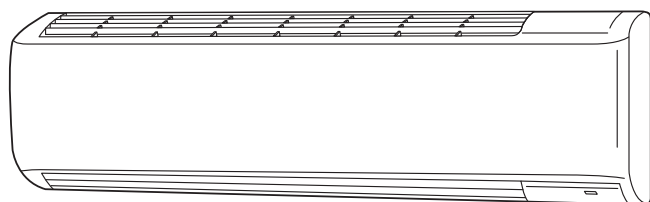

CS-KE30NKU
CS-KE36NKU



Outdoor Unit

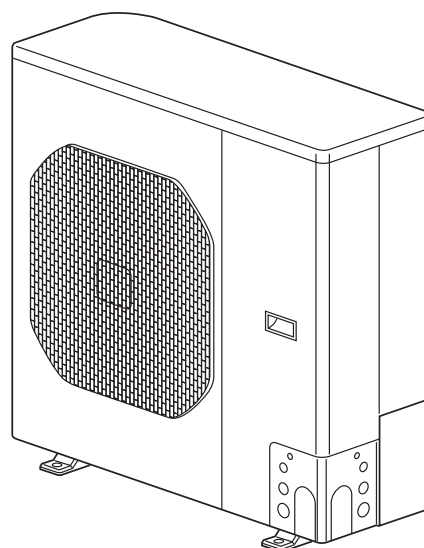

CU-KE30NKU
CU-KE36NKU









IMPORTANT















These air conditioners employ new refrigerant R410A.









Pay special attention when servicing the unit.

R410A

SAFETY PRECAUTIONS

- Before doing repair work, please read the " SAFETY PRECAUTIONS" carefully and fully understand them.
- The precautionary items here are divided into " Warning" and " Caution" items.
Items in particular which may cause death or serious injury to the service personnel if the work is not performed correctly, are included in the " Warning" table.
However, even precautionary items identified as " Caution" also have the potential for serious consequences if not performed correctly.
Important safety precautions are described for all items in both categories. Be sure to carefully follow all of them.
- Symbol Indication
 -  : This symbol indicates items to which we need to pay attention.
In this triangle, a definite precautionary item is described.
 -  : This symbol indicates the item to be prohibited.
In or close to this circle, a prohibited item is described.
 -  : This symbol indicates the items requiring special attention or instruction.
In or close to this circle, a prohibited item is described.
- After doing repair work, perform a test run to confirm that there are no abnormalities.
At the same time, explain the precautions in use to the user.

 Warning	
Before performing an overhaul, disconnect the power plug or power cable from the unit. Performing the work with the power supplied to the unit, may cause an electric shock.	
When repair work or circuit inspection that requires power supply for the air conditioner, is to be performed, do not touch the charging section. Doing so may cause an electric shock.	 Prohibit
For the step-up capacitor attached to the electric section, perform the repair work after sufficiently discharging it. Insufficient capacitor discharge may cause an electric shock.	
Do not perform repair work on the electric sections with wet hands. Doing so may cause an electric shock.	 Prohibit
Do not start or stop the air conditioner by means of connecting or disconnecting the power plug. Doing so may cause an electric shock or fire.	 Prohibit
When conducting repair work only use components included in the parts list for the corresponding unit and perform the work with the appropriate tools. Incorrect or poor repair work may cause an electric shock or fire.	
Never modify the unit. Doing so may cause an electric shock or fire.	 Prohibit
Perform all electric work according to local applicable regulations related to electrical equipment or interior wiring regulation and make sure to use the exclusive circuit. Insufficient capacity to the electric circuit or defective arrangement results may cause an electric shock or fire.	
Make sure to replace any power cable or lead wire showing any signs of scratch or deterioration. Failure to do so may cause an electric shock, overheating or fire.	
Make sure that there is no dust on or slack in the power plug and insert fully into the socket. Dust or incomplete connections may cause an electric shock or fire.	
Do not damage or process the power cord, as it may cause an electric shock or fire.	 Prohibit
For the wiring between the indoor unit and outdoor unit, securely fix the specified cable onto the terminal plate. Poorly fixed wiring may cause a heat or fire.	
After connecting the wiring between the indoor unit and outdoor unit, attach the terminal cover securely. Incomplete attachment of the terminal cover may cause overheating or fire.	

 Warning	
If refrigerant gas blows off during the work, do not touch the refrigerant gas as it may cause frostbite.	 Prohibit
If refrigerant gas leaks during the work, ventilate the room. If refrigerant gas catches fire, harmful gas may be generated.	
Do not mix any gas other than the specified refrigerant gas in the refrigerating cycle. If air or other contaminants mix with the gas, pressure will become extremely high in the refrigerating cycle, which may cause a unit breakdown."	 Prohibit
When the welded section of the compressor intake or discharge pipe is to be disconnected, perform it in a well-ventilated place after sufficiently recovering the refrigerant gas. Any residue gas may jet out refrigerant or refrigerating machine oil, which may cause an injury.	
When the work is to be performed in a high place (About 2 meters or more), make sure to wear a safety helmet, gloves and safety belt. Insufficient safety gear may cause a serious injury in case of a fall.	
When the unit is to be relocated, confirm that the new installation location has sufficient strength for the weight of the unit. Insufficient strength of the installation location and incomplete installation work may cause an injury due to the unit falling.	
When the remote controller batteries are replaced, dispose of the old batteries out of the reach of children. If a child swallows a battery, make sure that the child gets immediate medical attention.	













 Caution	
Do not wash the air conditioner with water, as this may cause an electric shock or fire.	 Prohibit
For the repair work in places with high humidity or moisture, make sure to ground the unit. Failure to do so may cause an electric shock.	
Confirm that the component attachment position, wiring condition, soldering condition and connector connection are normal. If not, it may cause overheating or fire.	
Confirm that the temperature around the compressor is not too high, and then perform the repair work. Failure to do so may cause a burn.	
Perform welding work in a place with good ventilation. If the work is performed in a poorly ventilated area, it might cause a lack of oxygen.	
If the installation plate or attachment frame has deteriorated due to corrosion, etc., replace it. Failure to do so may cause an injury due to the unit falling.	
When the cleaning is to be performed, make sure to turn off the power and pull out the plug. Touching the fan that is rotating at high speed may result in an injury.	
When the indoor unit is to be removed, do not place it on an incline. Doing so may cause wet furniture because water left inside may trickle down.	 Prohibit
Do not hold the sharp end of the unit or the aluminum fins, as it may cause an injury to your hand or finger.	 Prohibit
After repairs, make sure to measure the insulation resistance and confirm that the value is 1 Mohm or more. Any insulation error may cause an electric shock.	
After repairs, make sure to check the drainage of the indoor unit. Inappropriate drainage may cause wet furniture and floors due to water leakage.	

Table of Contents

	Page
⚠ SAFETY PRECAUTIONS	2
TABLE OF CONTENTS	4
1. OPERATING RANGE	6
2. SPECIFICATIONS	
2-1. Unit Specifications	7
2-2. Major Component Specifications	11
2-3. Other Component Specifications	15
3. DIMENSIONAL DATA	16
4. REFRIGERANT FLOW DIAGRAM	
4-1. Refrigerant Flow Diagram	18
5. PERFORMANCE DATA	
5-1. Temperature Charts	19
5-2. Cooling Capacity	23
5-3. Cooling Capacity (Low Ambient)	25
5-4. Heating Capacity	27
5-5. Air Throw Distance Charts	29
6. ELECTRICAL DATA	
6-1. Electrical Characteristics	31
6-2. Electric Wiring Diagrams	33
7. FUNCTIONS	
7-1. Operation Functions	35
7-2. Protective Functions	39
8. TROUBLESHOOTING (BEFORE CALLING FOR SERVICE)	
8-1. Precautions before Performing Inspection or Repair	41
8-2. Method of Self-Diagnostics	41
8-3. Checking the Indoor and Outdoor Units	44
8-4. Trouble Diagnosis of Fan Motor	48
8-5. Noise Malfunction and Electromagnetic Interference	50

9. CHECKING ELECTRICAL COMPONENTS

9-1. Measurement of Insulation Resistance	51
9-2. Checking Continuity of Fuse on PCB Ass'y	52

10. REFRIGERANT R410A:**SPECIAL PRECAUTIONS WHEN SERVICING UNIT**

10-1. Characteristics of New Refrigerant R410A	53
10-2. Checklist before Servicing	54
10-3. Tools Specifically for R410A	55
10-4. Tubing Installation Procedures	55
10-5. In Case of Compressor Malfunction	56
10-6. In Case Refrigerant is Leaking	58
10-7. Charging Additional Refrigerant	59
10-8. Retro-Fitting Existing Systems	59

APPENDIX A Operating Instructions	A-1
--	-----

APPENDIX B INSTALLAION INSTRUCTIONS	A-2
--	-----

1. OPERATING RANGE

	Temperature	Indoor Air Intake Temp.	Outdoor Air Intake Temp.
Cooling	Maximum	95 °F DB / 71 °F WB	115 °F DB
	Minimum	67 °F DB / 57 °F WB	0 °F DB
Heating	Maximum	80 °F DB / 67 °F WB	75 °F DB / 65 °F WB
	Minimum	– DB / – WB	– DB / 0 °F WB

2. SPECIFICATIONS

2-1. Unit Specifications

Indoor Unit **CS-KE30NKU**

Outdoor Unit **CU-KE30NKU**

< 230V >

Voltage Rating		230V Single-Phase 60Hz			
Performance	Total Capacity	BTU/h	30,600 (10,900 to 30,600)	33,000 (14,000 to 33,000)	
		kW	9.0 (3.2 to 9.0)	9.7 (4.1 to 9.7)	
	Sensible Capacity	BTU/h	18,600	-	
	Latent Capacity	BTU/h	12,000	-	
	Air Circulation (Hi/Me/Lo)	ft ³ /min (m ³ /h)	630(1,070)/530(901)/412(700)	671(1,140)/559(950)/441(749)	
	Moisture Removal (High)	Pints/h	9.57	-	
Electrical Rating	Available Voltage Range	V	187 to 253		
	Running Amperes	A	16.5 (5.0 to 16.5)	15.3 (4.5 to 15.3)	
	Power Input	W	3,290 (1,000 to 3,290)	3,070 (900 to 3,070)	
	Power Factor	%	87	87	
	EER	BTU/h/W	9.30	-	
	COP	W/W	-	3.15	
	SEER	BTU/Wh	16.0	-	
	HSPF	BTU/Wh	-	9.0	
	Compressor Locked Rotor Amperes	A	31.0		
	Fuse or Circuit Breaker Capacity	A	35		
Features	Controls / Temperature Control		Microprocessor / I.C. Thermister		
	Control Unit		Wireless Remote Control Unit		
	Timer		24-Hour ON or OFF Timer, 1-Hour OFF Timer		
	Fan Speeds	Indoor / Outdoor	Auto and 3 steps / Auto (Hi, Me, Lo)		
	Airflow Direction (Indoor)	Horizontal	Manual		
		Vertical	Auto		
	Air Filter		Washable, Anti-Mold		
	Compressor		DC Twin Rotary (Inverter)		
	Refrigerant / Amount charged at shipment	lbs (g)	R410A / 6.5 (2,950)		
	Refrigerant Control		Electric Expansion Valve		
	Operation Sound	Indoor : Hi/Me/Lo/Qt*	dB-A	49 / 44 / 39 / 32	49 / 44 / 39 / 32
		Outdoor : Hi	dB-A	55	55
	Refrigerant Tubing Connections		Flare Type		
	Max. allowable tubing length at shipment	ft (m)	164 (50)		
	Refrigerant	Narrow tube	inch (mm)	3/8 (9.52)	
Wide tube		inch (mm)	5/8 (15.88)		
Refrigerant Tube Kit		Optional			
Dimensions & Weight			Indoor Unit	Outdoor Unit	
	Unit Dimensions	inch	11-13/16 × 41-15/16 × 9-1/16	35-13/16 × 37-1/32 × 13-3/8	
		(mm)	(300 × 1,065 × 230)	(910 × 940 × 340)	
	Package Dimensions	inch	12-7/32 × 44-7/8 × 14-31/32	42-3/8 × 40 × 16-3/8	
		(mm)	(310 × 1,140 × 380)	(1,076 × 1,016 × 416)	
	Weight	Net	lbs (kg)	32.0 (14.5)	185.2 (84.0)
Shipping		lbs (kg)	39.7 (18.0)	207.2 (94.0)	
Shipping Volume		cu.ft (m ³)	4.59 (0.13)	15.88 (0.45)	

DATA SUBJECT TO CHANGE WITHOUT NOTICE.

Remarks: Rating conditions are:

Cooling: Indoor air temperature 80 °F DB / 67 °F WB
 Outdoor air temperature 95 °F DB / 75 °F WB

Heating: Indoor air temperature 70 °F DB
 Outdoor air temperature 47 °F DB / 43 °F WB

Indoor Unit **CS-KE30NKU**
 Outdoor Unit **CU-KE30NKU**

< 208V >

Voltage Rating		208V Single-Phase 60Hz			
Performance	Total Capacity	BTU/h	30,600 (10,900 to 30,600)	33,000 (14,000 to 33,000)	
		kW	9.0 (3.2 to 9.0)	9.7 (4.1 to 9.7)	
	Sensible Capacity	BTU/h	18,600	-	
	Latent Capacity	BTU/h	12,000	-	
	Air Circulation (Hi/Me/Lo)	ft ³ /min (m ³ /h)	630(1,070)/530(901)/412(700)	671(1,140)/559(950)/441(749)	
	Moisture Removal (High)	Pints/h	9.57	-	
Electrical Rating	Available Voltage Range	V	187 to 253		
	Running Amperes	A	18.0 (5.0 to 18.0)	16.8 (4.5 to 16.8)	
	Power Input	W	3,290 (1,000 to 3,290)	3,070 (900 to 3,070)	
	Power Factor	%	88	88	
	EER	BTU/h/W	9.30	-	
	COP	W/W	-	3.15	
	SEER	BTU/Wh	16.0	-	
	HSPF	BTU/Wh	-	9.0	
	Compressor Locked Rotor Amperes	A	31.0		
	Fuse or Circuit Breaker Capacity	A	35		
Features	Controls / Temperature Control		Microprocessor / I.C. Thermister		
	Control Unit		Wireless Remote Control Unit		
	Timer		24-Hour ON or OFF Timer, 1-Hour OFF Timer		
	Fan Speeds	Indoor / Outdoor	Auto and 3 steps / Auto (Hi, Me, Lo)		
	Airflow Direction (Indoor)	Horizontal	Manual		
		Vertical	Auto		
	Air Filter		Washable, Anti-Mold		
	Compressor		DC Twin Rotary (Inverter)		
	Refrigerant / Amount charged at shipment	lbs (g)	R410A / 6.5 (2,950)		
	Refrigerant Control		Electric Expansion Valve		
	Operation Sound	Indoor : Hi/Me/Lo/Qt*	dB-A	49 / 44 / 39 / 32	49 / 44 / 39 / 32
		Outdoor : Hi	dB-A	55	55
	Refrigerant Tubing Connections		Flare Type		
	Max. allowable tubing length at shipment	ft (m)	164 (50)		
Refrigerant	Narrow tube	inch (mm)	3/8 (9.52)		
Tube Diameter	Wide tube	inch (mm)	5/8 (15.88)		
Refrigerant Tube Kit		Optional			
Dimensions & Weight			Indoor Unit	Outdoor Unit	
	Unit Dimensions	inch	11-13/16 × 41-15/16 × 9-1/16	35-13/16 × 37-1/32 × 13-3/8	
	Height × Width × Depth	(mm)	(300 × 1,065 × 230)	(910 × 940 × 340)	
	Package Dimensions	inch	12-7/32 × 44-7/8 × 14-31/32	42-3/8 × 40 × 16-3/8	
	Height × Width × Depth	(mm)	(310 × 1,140 × 380)	(1,076 × 1,016 × 416)	
	Weight	Net	lbs (kg)	32.0 (14.5)	185.2 (84.0)
Shipping		lbs (kg)	39.7 (18.0)	207.2 (94.0)	
Shipping Volume		cu.ft (m ³)	4.59 (0.13)	15.88 (0.45)	

DATA SUBJECT TO CHANGE WITHOUT NOTICE.

Remarks: Rating conditions are:

Cooling: Indoor air temperature 80 °F DB / 67 °F WB
 Outdoor air temperature 95 °F DB / 75 °F WB

Heating: Indoor air temperature 70 °F DB
 Outdoor air temperature 47 °F DB / 43 °F WB

Indoor Unit **CS-KE36NKU**
 Outdoor Unit **CU-KE36NKU**

< 230V >

Voltage Rating		230V Single-Phase 60Hz		
Performance	Total Capacity	BTU/h	34,000 (10,900 to 34,000)	36,000 (14,000 to 36,000)
		kW	10.0 (3.2 to 10.0)	10.5 (4.1 to 10.5)
	Sensible Capacity	BTU/h	20,700	-
	Latent Capacity	BTU/h	13,300	-
	Air Circulation (Hi/Me/Lo)	ft ³ /min (m ³ /h)	630(1,070)/530(901)/412(700)	671(1,140)/559(950)/441(749)
	Moisture Removal (High)	Pints/h	10.64	-
Electrical Rating	Available Voltage Range	V	187 to 253	
	Running Amperes	A	20.0 (5.0 to 20.0)	18.2 (4.5 to 18.2)
	Power Input	W	4,000 (1,000 to 4,000)	3,650 (900 to 3,650)
	Power Factor	%	87	87
	EER	BTU/h/W	8.50	-
	COP	W/W	-	2.89
	SEER	BTU/Wh	16.0	-
	HSPF	BTU/Wh	-	9.0
	Compressor Locked Rotor Amperes	A	31.0	
	Fuse or Circuit Breaker Capacity	A	45	
Features	Controls / Temperature Control		Microprocessor / I.C. Thermister	
	Control Unit		Wireless Remote Control Unit	
	Timer		24-Hour ON or OFF Timer, 1-Hour OFF Timer	
	Fan Speeds Indoor / Outdoor		Auto and 3 steps / Auto (Hi, Me, Lo)	
	Airflow Direction (Indoor)		Manual	
			Auto	
	Air Filter		Washable, Anti-Mold	
	Compressor		DC Twin Rotary (Inverter)	
	Refrigerant / Amount charged at shipment lbs (g)		R410A / 6.5 (2,950)	
	Refrigerant Control		Electric Expansion Valve	
	Operation Sound Indoor : Hi/Me/Lo/Qt* dB-A		49 / 44 / 39 / 32	49 / 44 / 39 / 32
	(*Qt = Quiet mode) Outdoor : Hi dB-A		55	56
	Refrigerant Tubing Connections		Flare Type	
	Max. allowable tubing length at shipment ft (m)		164 (50)	
Refrigerant Narrow tube inch (mm)		3/8 (9.52)		
Tube Diameter Wide tube inch (mm)		5/8 (15.88)		
Refrigerant Tube Kit		Optional		
Dimensions & Weight			Indoor Unit	Outdoor Unit
	Unit Dimensions inch		11-13/16 × 41-15/16 × 9-1/16	35-13/16 × 37-1/32 × 13-3/8
	Height × Width × Depth (mm)		(300 × 1,065 × 230)	(910 × 940 × 340)
	Package Dimensions inch		12-7/32 × 44-7/8 × 14-31/32	42-3/8 × 40 × 16-3/8
	Height × Width × Depth (mm)		(310 × 1,140 × 380)	(1,076 × 1,016 × 416)
	Weight			
Net lbs (kg)		32.0 (14.5)	185.2 (84.0)	
Shipping lbs (kg)		39.7 (18.0)	207.2 (94.0)	
Shipping Volume cu.ft (m ³)		4.59 (0.13)	15.88 (0.45)	

DATA SUBJECT TO CHANGE WITHOUT NOTICE.

Remarks: Rating conditions are:

Cooling: Indoor air temperature 80 °F DB / 67 °F WB
 Outdoor air temperature 95 °F DB / 75 °F WB

Heating: Indoor air temperature 70 °F DB
 Outdoor air temperature 47 °F DB / 43 °F WB

Indoor Unit **CS-KE36NKU**
 Outdoor Unit **CU-KE36NKU**

< 208V >

Voltage Rating		208V Single-Phase 60Hz			
Performance	Total Capacity	BTU/h	34,000 (10,900 to 34,000)	36,000 (14,000 to 36,000)	
		kW	10.0 (3.2 to 10.0)	10.5 (4.1 to 10.5)	
	Sensible Capacity	BTU/h	20,700	-	
	Latent Capacity	BTU/h	13,300	-	
	Air Circulation (Hi/Me/Lo)	ft ³ /min (m ³ /h)	630(1,070)/530(901)/412(700)	671(1,140)/559(950)/441(749)	
	Moisture Removal (High)	Pints/h	10.64	-	
Electrical Rating	Available Voltage Range	V	187 to 253		
	Running Amperes	A	21.9 (5.0 to 21.9)	19.9 (4.5 to 19.9)	
	Power Input	W	4,000 (1,000 to 4,000)	3,650 (900 to 3,650)	
	Power Factor	%	88	88	
	EER	BTU/h/W	8.50	-	
	COP	W/W	-	2.89	
	SEER	BTU/Wh	16.0	-	
	HSPF	BTU/Wh	-	9.0	
	Compressor Locked Rotor Amperes	A	31.0		
	Fuse or Circuit Breaker Capacity	A	45		
Features	Controls / Temperature Control		Microprocessor / I.C. Thermister		
	Control Unit		Wireless Remote Control Unit		
	Timer		24-Hour ON or OFF Timer, 1-Hour OFF Timer		
	Fan Speeds	Indoor / Outdoor	Auto and 3 steps / Auto (Hi, Me, Lo)		
	Airflow Direction (Indoor)	Horizontal	Manual		
		Vertical	Auto		
	Air Filter		Washable, Anti-Mold		
	Compressor		DC Twin Rotary (Inverter)		
	Refrigerant / Amount charged at shipment	lbs (g)	R410A / 6.5 (2,950)		
	Refrigerant Control		Electric Expansion Valve		
	Operation Sound	Indoor : Hi/Me/Lo/Qt*	dB-A	49 / 44 / 39 / 32	49 / 44 / 39 / 32
		Outdoor : Hi	dB-A	55	56
	Refrigerant Tubing Connections		Flare Type		
	Max. allowable tubing length at shipment	ft (m)	164 (50)		
Refrigerant	Narrow tube	inch (mm)	3/8 (9.52)		
Tube Diameter	Wide tube	inch (mm)	5/8 (15.88)		
Refrigerant Tube Kit		Optional			
Dimensions & Weight			Indoor Unit	Outdoor Unit	
	Unit Dimensions	inch	11-13/16 × 41-15/16 × 9-1/16	35-13/16 × 37-1/32 × 13-3/8	
		(mm)	(300 × 1,065 × 230)	(910 × 940 × 340)	
	Package Dimensions	inch	12-7/32 × 44-7/8 × 14-31/32	42-3/8 × 40 × 16-3/8	
		(mm)	(310 × 1,140 × 380)	(1,076 × 1,016 × 416)	
	Weight	Net	lbs (kg)	32.0 (14.5)	185.2 (84.0)
Shipping		lbs (kg)	39.7 (18.0)	207.2 (94.0)	
Shipping Volume		cu.ft (m ³)	4.59 (0.13)	15.88 (0.45)	

DATA SUBJECT TO CHANGE WITHOUT NOTICE.

Remarks: Rating conditions are:

Cooling: Indoor air temperature 80 °F DB / 67 °F WB
 Outdoor air temperature 95 °F DB / 75 °F WB

Heating: Indoor air temperature 70 °F DB
 Outdoor air temperature 47 °F DB / 43 °F WB

2-2. Major Component Specifications

2-2-1. Indoor Unit

Indoor Unit **CS-KE30NKU**

Control PCB		
Part No.		CB-CS-KE30NKU
Controls		Microprocessor
Control Circuit Fuse		250V 3A

Fan		
Type		Cross-Flow
Q'ty ... Dia. and Length	inch (mm)	1 ... D3-15/16 / L32-1 (D100/L838)

Fan Motor		
Type		DC Motor
Model ... Q'ty		SIC-41CVJ-D847-1 ... 1
No. of Poles		8
Rough Measure RPM (Cool / Heat)		1,370 / 1,450
Nominal Output	W	47
Coil Resistance (Ambient Temp. 68 °F (20 °C))	Ohm	-
Safety Device		
Type		Internal Controller
Over-Current Protection		Yes
Over-Heat Protection		Yes
Run Capacitor	Micro F	-
	VAC	-

Flap Motor		
Type		Stepping Motor
Model		24BYJ48-1256
Rating		DC 12V
Coil Resistance (Ambient Temp. 77 °F (25 °C))	Ohm	Each Pair of Terminal : 200 +/- 7%

Heat Exchanger Coil		
Coil		Aluminum Plate Fin / Copper Tube
Rows		1 and 2
Fins Per inch		19.5
Face Area	ft ² (m ²)	4.55 (0.423)

DATA SUBJECT TO CHANGE WITHOUT NOTICE.

Indoor Unit **CS-KE36NKU**

Control PCB		
Part No.		CB-CS-KE36NKU
Controls		Microprocessor
Control Circuit Fuse		250V 3A

Fan		
Type		Cross-Flow
Q'ty ... Dia. and Length	inch (mm)	1 ... D3-15/16 / L32-1 (D100/L838)

Fan Motor		
Type		DC Motor
Model ... Q'ty		SIC-41CVJ-D847-1 ... 1
No. of Poles		8
Rough Measure RPM (Cool / Heat)		1,370 / 1,450
Nominal Output	W	47
Coil Resistance (Ambient Temp. 68 °F (20 °C))	Ohm	-
Safety Device		
Type		Internal Controller
Over-Current Protection		Yes
Over-Heat Protection		Yes
Run Capacitor	Micro F	-
	VAC	-

Flap Motor		
Type		Stepping Motor
Model		24BYJ48-1256
Rating		DC 12V
Coil Resistance (Ambient Temp. 77 °F (25 °C))	Ohm	Each Pair of Terminal : 200 +/- 7%

Heat Exchanger Coil		
Coil		Aluminum Plate Fin / Copper Tube
Rows		1 and 2
Fins Per inch		19.5
Face Area	ft ² (m ²)	4.55 (0.423)

DATA SUBJECT TO CHANGE WITHOUT NOTICE.

2-2-2. Outdoor Unit

Outdoor Unit **CU-KE30NKU**

P.C.Board	Control P.C.B	Noise Filer P.C.B	H.I.C.Board
Part No.	CR-CH3082-F	POW-CH3082-B2	HIC-CH3072R-C1
Controls	Microprocessor	-	-
Circuit Fuse	400V 3.15A	250V 25A	-

Compressor	
Type	DC Twin Rotary (Hermetic)
Compressor Model / Nominal Output	C-9RVN273H0H / 2,250W
Compressor Oil ... Amount	Pints (cc) FV68S ... 2.98 (1,400)
Coil Resistance (Ambient Temp. 77 °F (25 °C))	Ohm T - R : 0.169 T - S : 0.169 R - S : 0.169
Safety Device	
CT (Peak current cut-off control)	Yes
Compressor Discharge Temp. Control	Yes
Operation cut-off control in abnormal ambient Temp.	Yes
Overload Relay	Model CS-7L110
	Operation Temp. Open : 230 °F (110 °C), Close : 203 °F (95 °C)
Run Capacitor	Micro F -
	VAC -
Crankcase Heater	230V 30W

Fan	
Type	Propeller
Q'ty ... Dia.	inch (mm) 1 ... D19-9/32 (D490)

Fan Motor	
Type	DC Motor
Model ... Q'ty	SIC-71FW-D8120-4A ... 1
No. of Poles	8
Rough Measure RPM (Cool / Heat)	750 / 750
Nominal Output	W 142
Coil Resistance	Ohm -
(Ambient Temp. 68 °F (20 °C))	
Safety Device	
Type	Internal Controller
Over- Current Protection	Yes
Over- Heat Protection	Yes
Run Capacitor	Micro F -
	VAC -

Heat Exchanger Coil	
Coil	Aluminum Plate Fin / Copper Tube
Rows	2
Fins per inch	21.2
Face Area	ft ² (m ²) 8.05 (0.748)

External Finish	Acrylic baked-on enamel finish
------------------------	--------------------------------

DATA SUBJECT TO CHANGE WITHOUT NOTICE.

Outdoor Unit **CU-KE36NKU**

P.C.Board	Control P.C.B	Noise Filer P.C.B	H.I.C.Board
Part No.	CR-CH3682-F	POW-CH3082-B2	HIC-CH3072R-C1
Controls	Microprocessor	-	-
Circuit Fuse	400V 3.15A	250V 25A	-

Compressor	
Type	DC Twin Rotary (Hermetic)
Compressor Model / Nominal Output	C-9RVN273H0H / 2,500W
Compressor Oil ... Amount	Pints (cc) FV68S ... 2.98 (1,400)
Coil Resistance (Ambient Temp. 77 °F (25 °C))	Ohm T - R : 0.169 T - S : 0.169 R - S : 0.169
Safety Device	
CT (Peak current cut-off control)	Yes
Compressor Discharge Temp. Control	Yes
Operation cut-off control in abnormal ambient Temp.	Yes
Overload Relay	Model CS-7L110
	Operation Temp. Open : 230 °F (110 °C), Close : 203 °F (95 °C)
Run Capacitor	Micro F -
	VAC -
Crankcase Heater	230V 30W

Fan	
Type	Propeller
Q'ty ... Dia.	inch (mm) 1 ... D19-9/32 (D490)

Fan Motor	
Type	DC Motor
Model ... Q'ty	SIC-71FW-D8120-4A ... 1
No. of Poles	8
Rough Measure RPM (Cool / Heat)	750 / 750
Nominal Output	W 142
Coil Resistance	Ohm -
(Ambient Temp. 68 °F (20 °C))	
Safety Device	
Type	Internal Controller
Over- Current Protection	Yes
Over- Heat Protection	Yes
Run Capacitor	Micro F -
	VAC -

Heat Exchanger Coil	
Coil	Aluminum Plate Fin / Copper Tube
Rows	2
Fins per inch	21.2
Face Area	ft ² (m ²) 8.05 (0.748)

External Finish	Acrylic baked-on enamel finish
------------------------	--------------------------------

DATA SUBJECT TO CHANGE WITHOUT NOTICE.

2-3. Other Component Specifications

Indoor Unit **CS-KE30NKU**
CS-KE36NKU
 Outdoor Unit **CU-KE30NKU**
CU-KE36NKU

- **Indoor air temp sensor**
 (Model:KTEC-35-135-1)

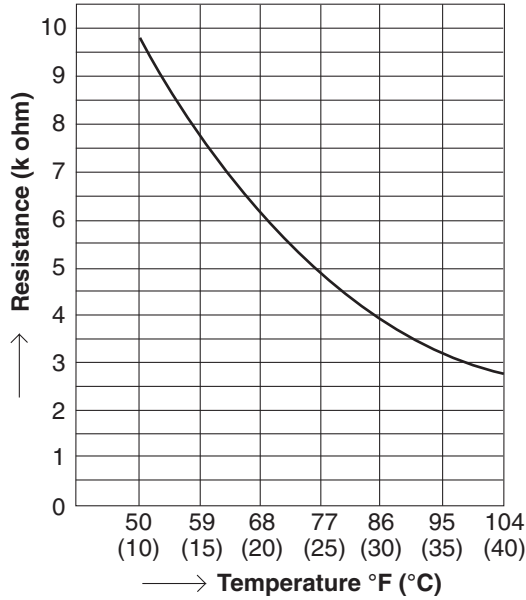

- **Indoor heat exchanger sensor**
 (Model:PTM-D51H-S6-1)
- **Compressor temp sensor**
 (Model:TKS335B)

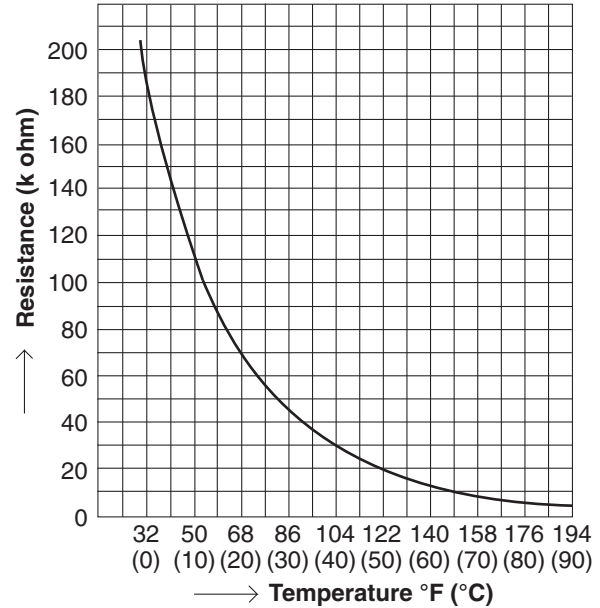

- **Outdoor air temp sensor**
 (Model:TKS295B)
- **Outdoor heat exchanger sensor**
 (Model:TKS334B)
- **Heat sink temp sensor (HIC Board)**
 (Model:TKS316B)

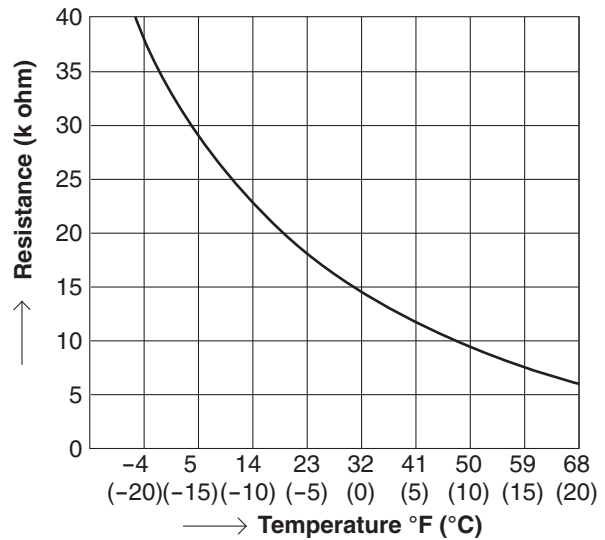

3. DIMENSIONAL DATA

Indoor Unit **CS-KE30NKU**
CS-KE36NKU

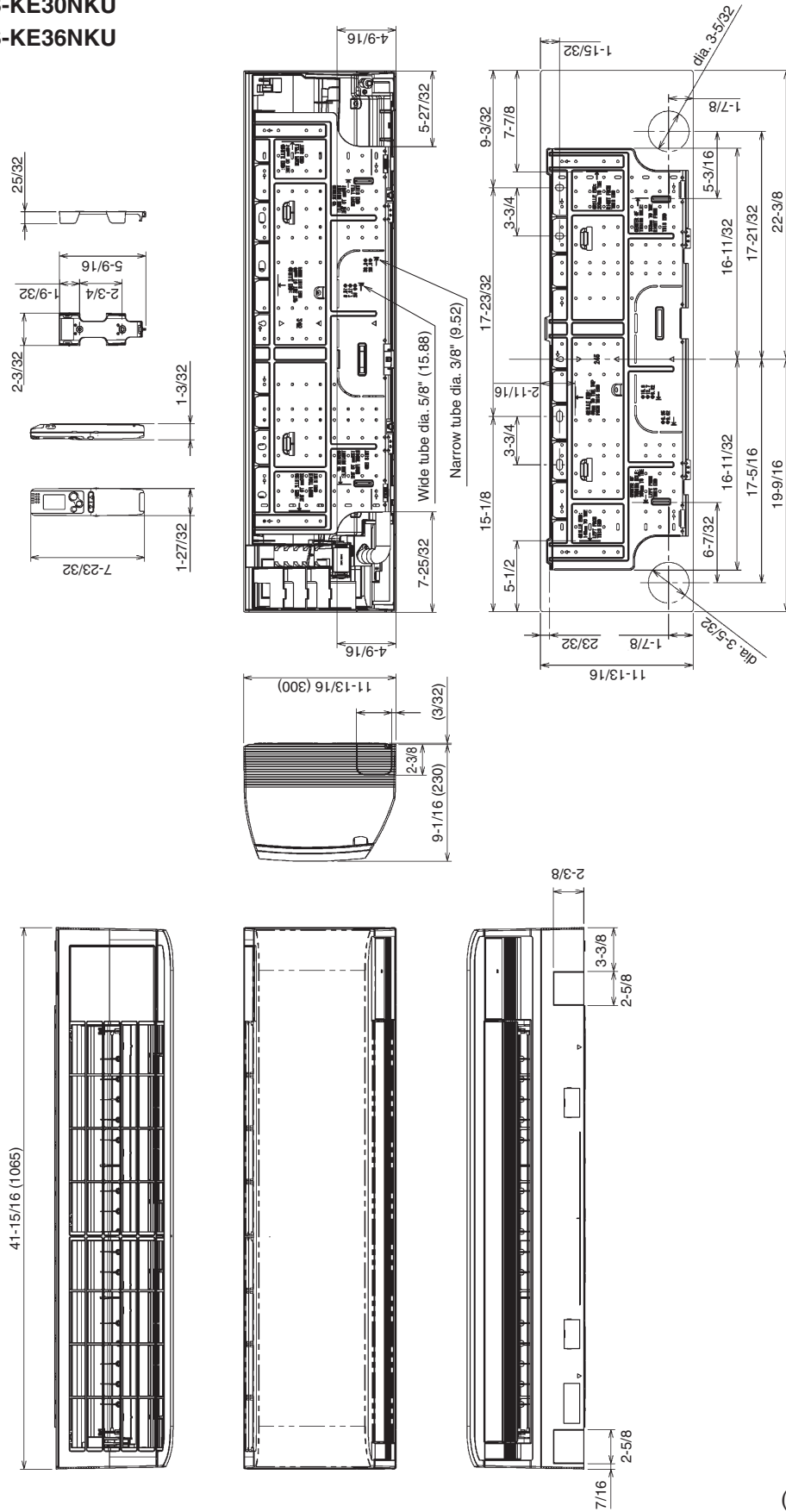

Unit: inch(mm)
(852-0-0010-196-00-0)

Outdoor Unit **CU-KE30NKU**
CU-KE36NKU

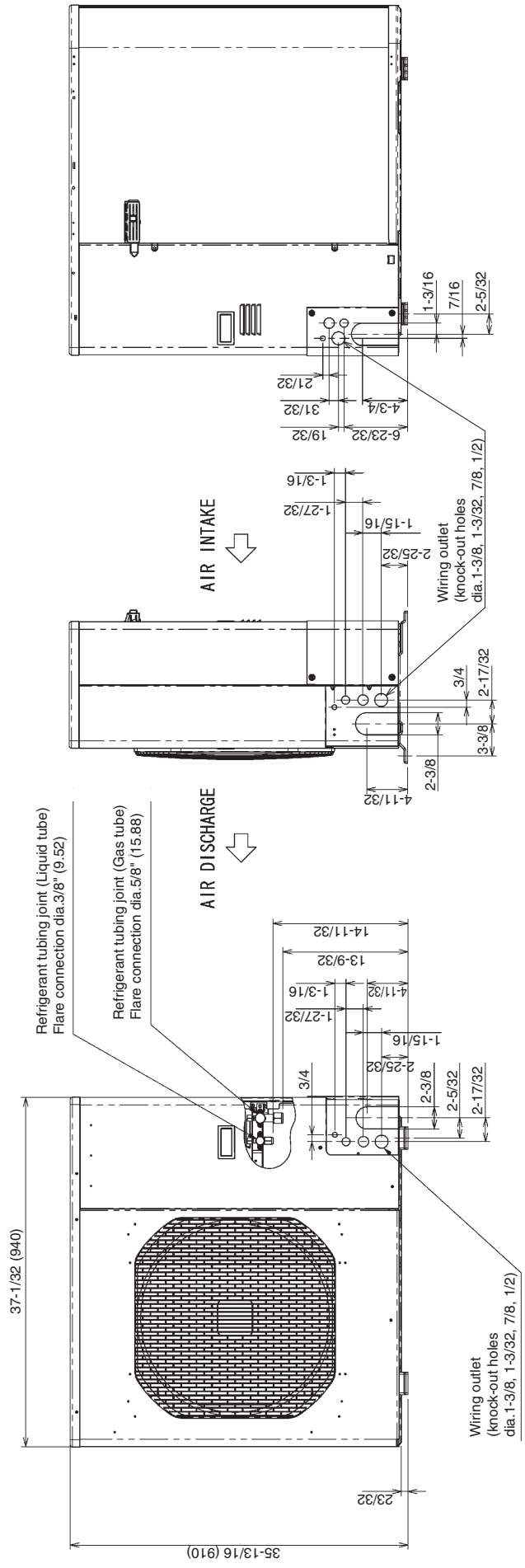
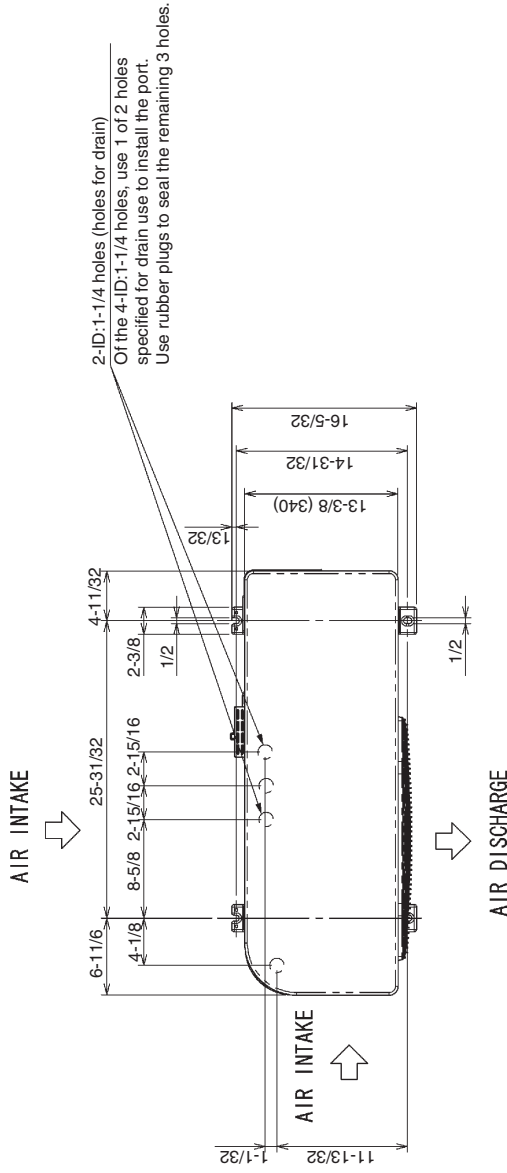

Unit: inch (mm)
(852-0-0010-194-00-1)

4. REFRIGERANT FLOW DIAGRAM

4-1. Refrigerant Flow Diagram

Indoor Unit **CS-KE30NKU**
CS-KE36NKU

Outdoor Unit **CU-KE30NKU**
CU-KE36NKU

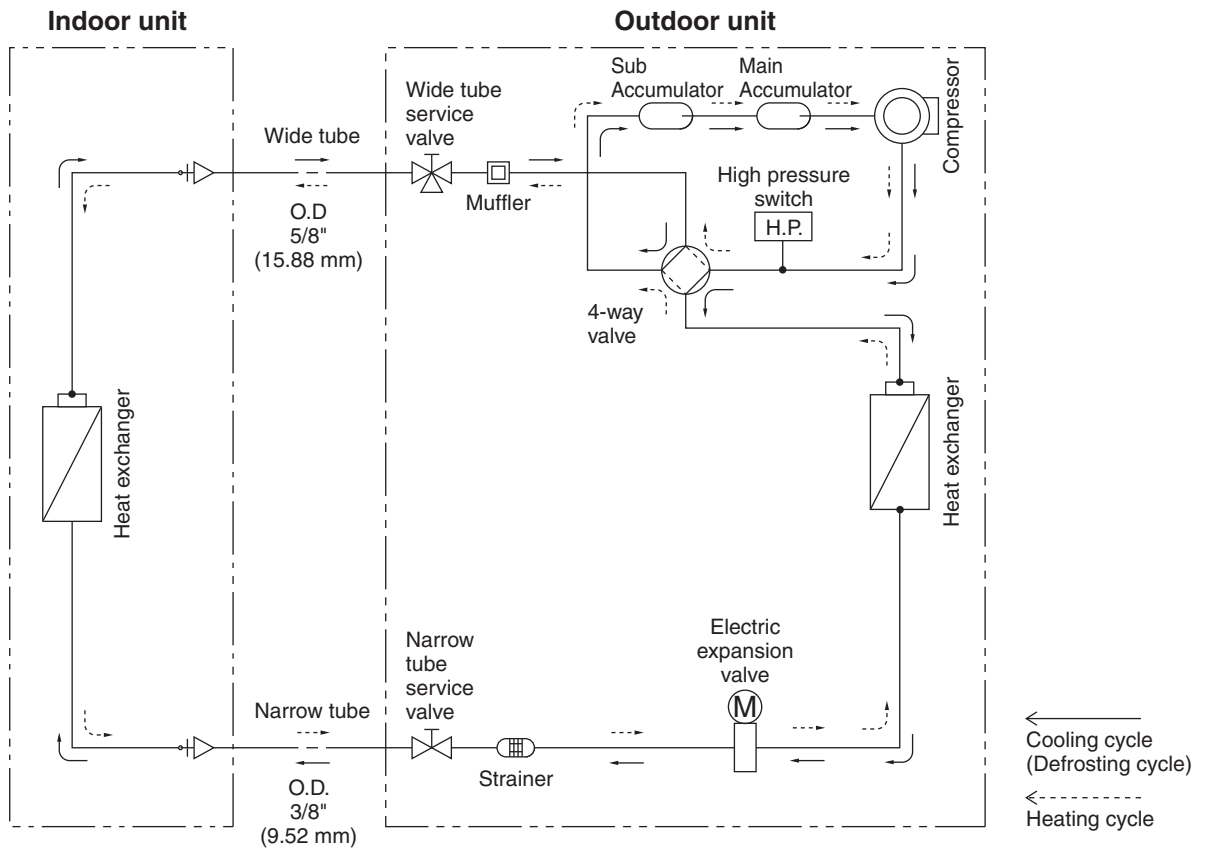

5. PERFORMANCE DATA

5-1. Temperature Charts

Indoor Unit **CS-KE30NKU**

Outdoor Unit **CU-KE30NKU**

■ Cooling Characteristics (RH : 46%, Indoor fan speed : High fan) (60Hz, 230V)

(1) Low pressure performance chart

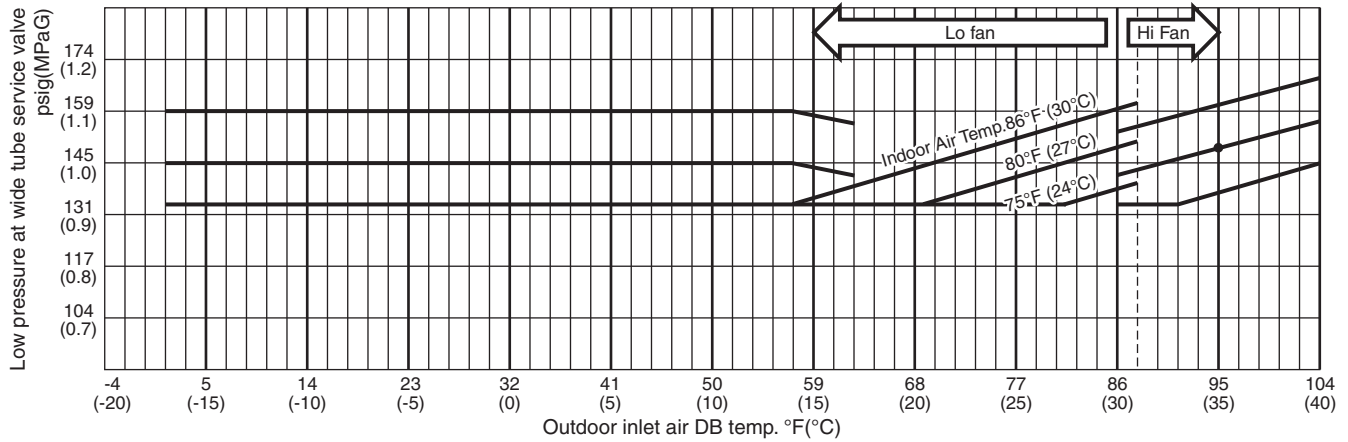

(2) Operating current performance chart

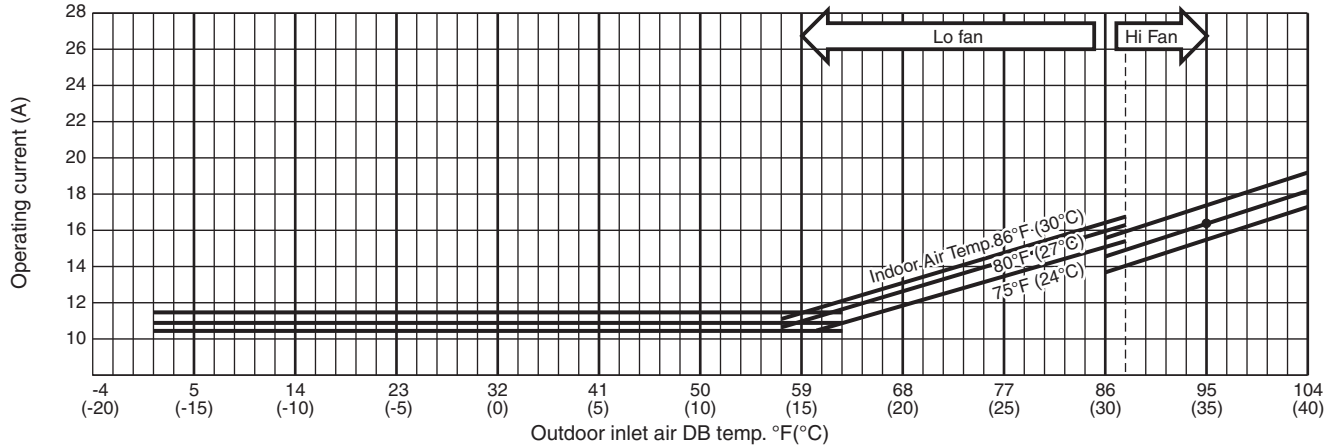

(3) Indoor discharge air performance chart

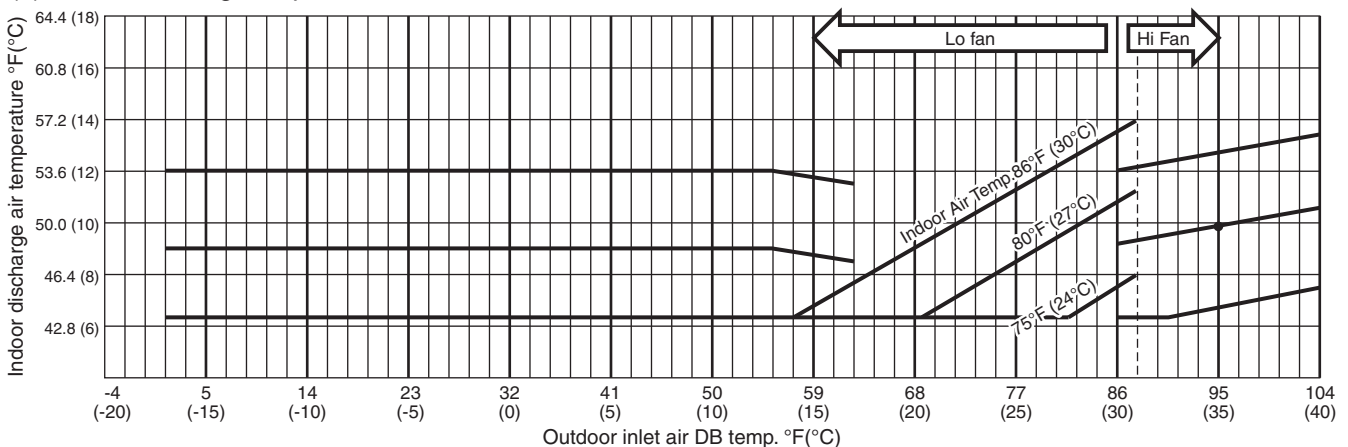

NOTE

• Check each performance value in test-run mode. Electrical performance values represent a combined indoor/outdoor value.

Indoor Unit **CS-KE30NKU**
 Outdoor Unit **CU-KE30NKU**

■ Heating Characteristics (RH : 46%, Indoor fan speed : High fan) (60Hz, 230V)

(1) High pressure performance chart

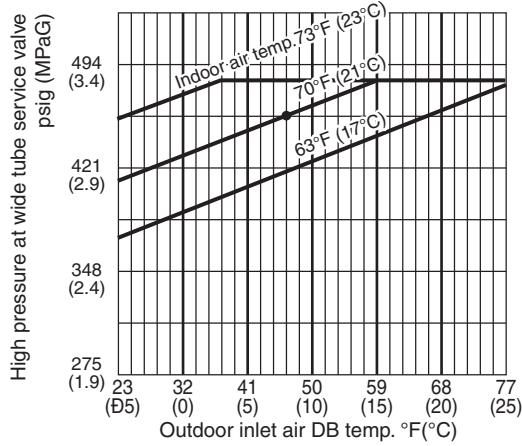

(2) Operating current performance chart

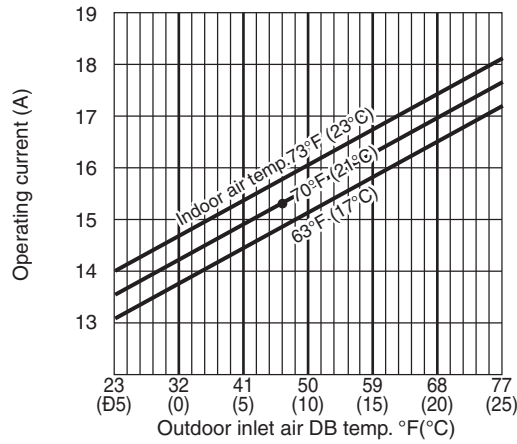

(3) Indoor discharge air performance chart

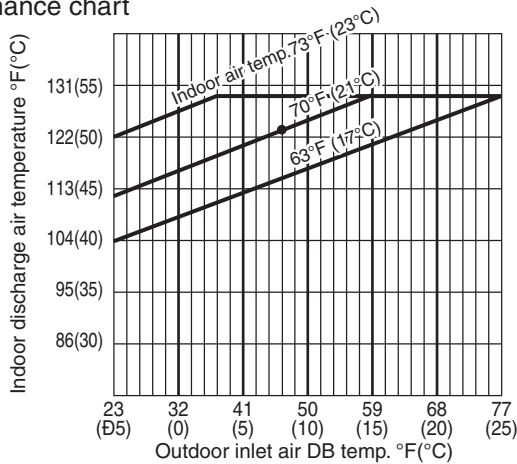

NOTE

- Check each performance value in test-run mode. Electrical performance values represent a combined indoor/outdoor value.
- Overload prevention operates to protect the air conditioner when outdoor ambient temperature becomes extremely high in heating mode. (Refer to "7-2. Protective Functions ■ Overload prevention during heating.")

Indoor Unit **CS-KE36NKU**

Outdoor Unit **CU-KE36NKU**

■ Cooling Characteristics (RH : 46%, Indoor fan speed : High fan) (60Hz, 230V)

(1) Low pressure performance chart

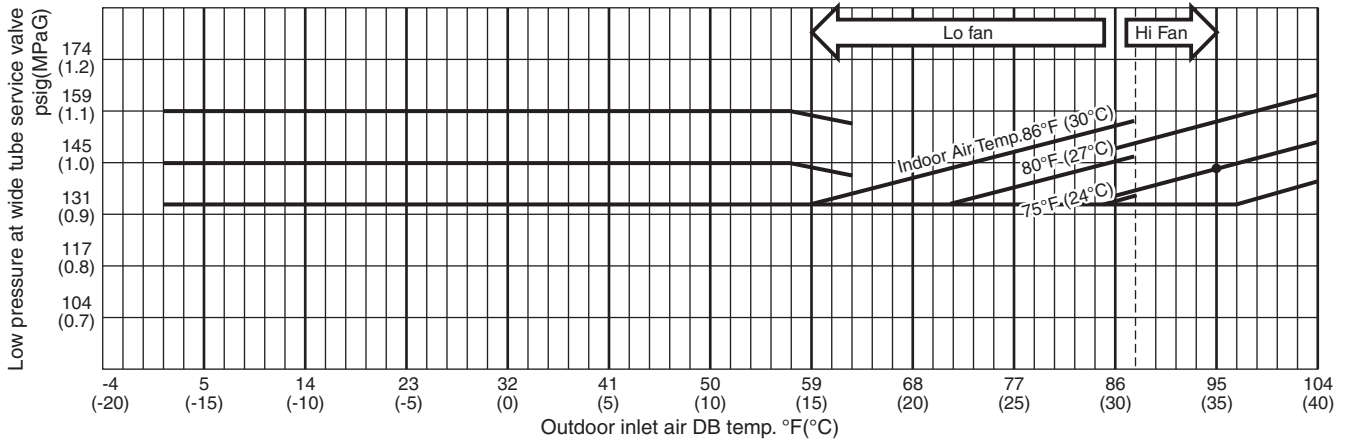

(2) Operating current performance chart

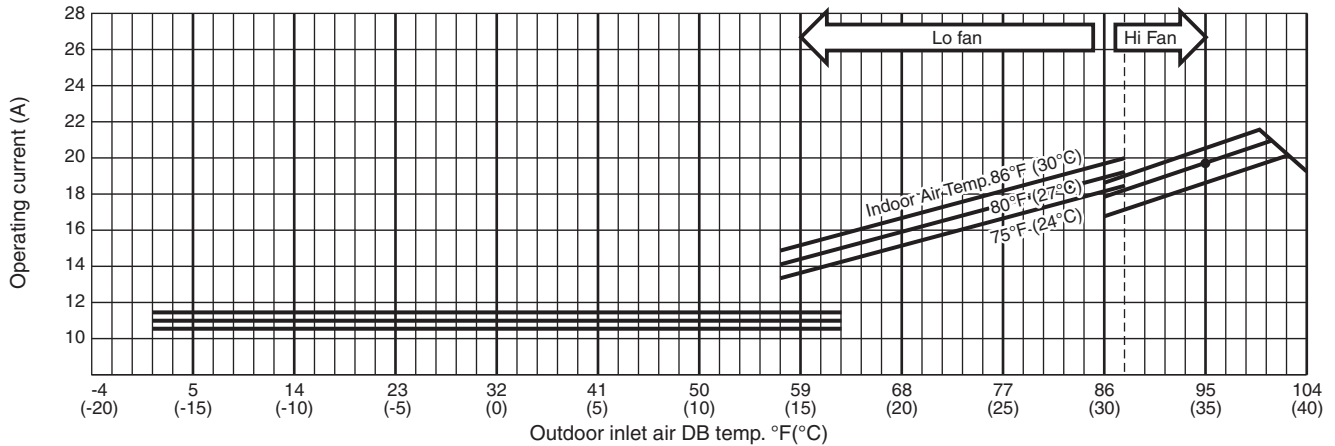

(3) Indoor discharge air performance chart

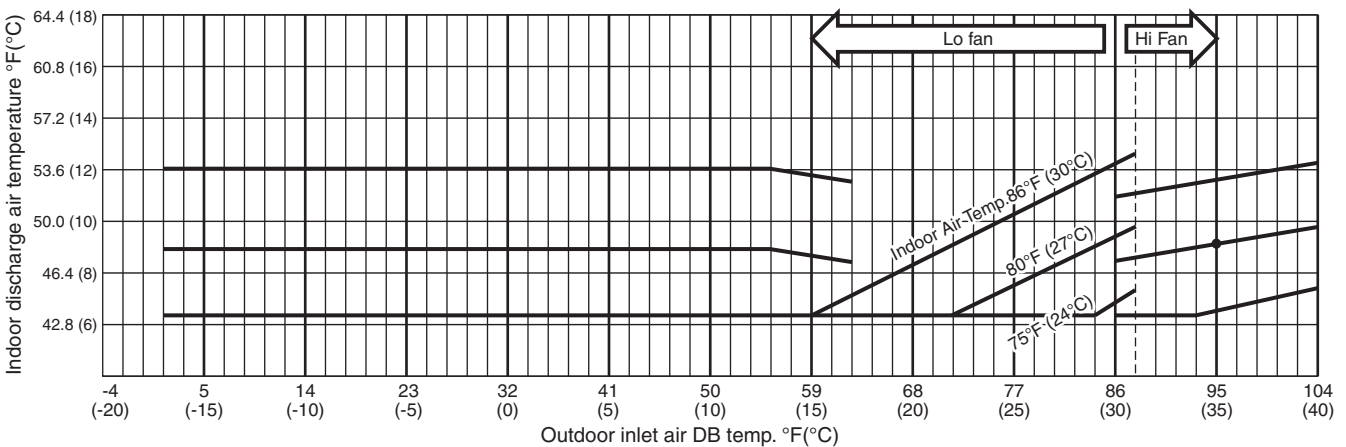

NOTE

• Check each performance value in test-run mode. Electrical performance values represent a combined indoor/outdoor value.

Indoor Unit **CS-KE36NKU**

Outdoor Unit **CU-KE36NKU**

■ Heating Characteristics (RH : 46%, Indoor fan speed : High fan) (60Hz, 230V)

(1) High pressure performance chart

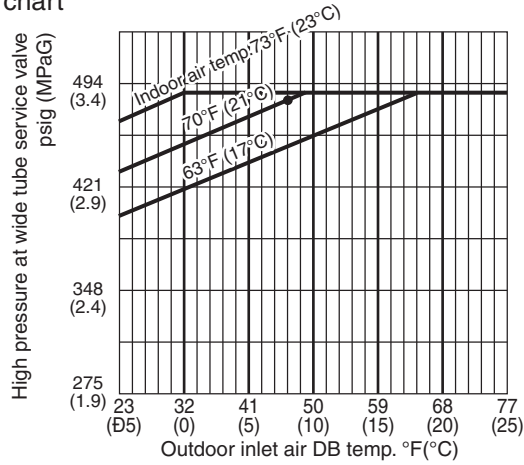

(2) Operating current performance chart

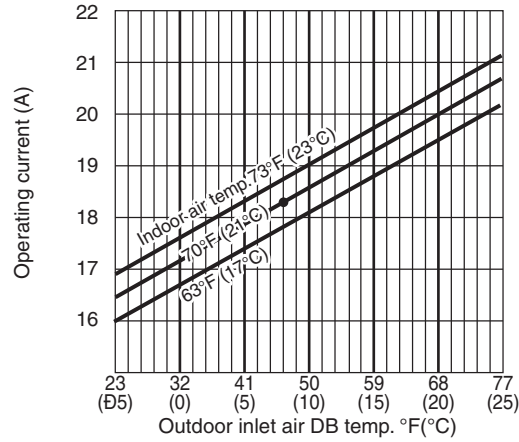

(3) Indoor discharge air performance chart

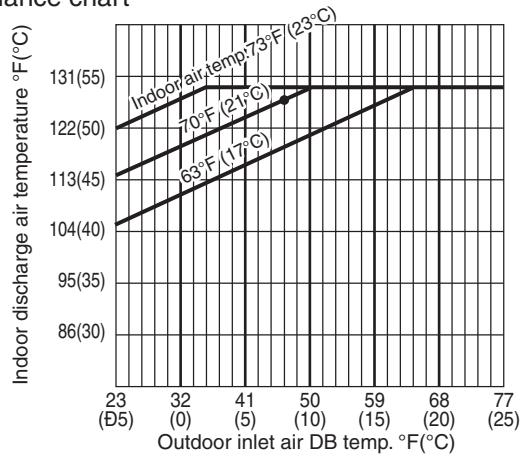

NOTE

- Check each performance value in test-run mode. Electrical performance values represent a combined indoor/outdoor value.
- Overload prevention operates to protect the air conditioner when outdoor ambient temperature becomes extremely high in heating mode. (Refer to "7-2. Protective Functions ■ Overload prevention during heating.")

5-2. Cooling Capacity

Indoor Unit : **CS-KE30NKU**

Outdoor Unit : **CU-KE30NKU**

Power Supply : 230V Single Phase 60Hz

< Cooling Capacity >

RATING CAPACITY:		30,600 BTU/h		AIR FLOW RATE:		630 CFM		
INDOOR		OUTDOOR						
ENT. TEMP. °F (°C)		AMBIENT TEMP. °F (°C)						
WB	DB		65 (18.3)	75 (23.9)	85 (29.4)	95 (35.0)	105 (40.6)	115 (46.1)
59 (15.0)		TC	26,540	27,120	27,710	27,910	24,890	17,310
	72 (22.2)	SHC	19,190	19,430	19,800	19,920	18,330	14,660
	76 (24.4)	SHC	21,510	21,880	22,120	22,250	20,660	16,990
	80 (26.7)	SHC	23,960	24,330	24,570	24,690	23,100	17,310
	84 (28.9)	SHC	26,280	26,650	26,890	27,020	24,890	17,310
	88 (31.1)	SHC	26,540	27,120	27,710	27,910	24,890	17,310
63 (17.2)		TC	31,580	30,910	30,160	29,630	25,270	17,560
	72 (22.2)	SHC	18,330	17,970	17,600	17,360	15,150	11,730
	76 (24.4)	SHC	20,660	20,290	19,920	19,680	17,480	14,050
	80 (26.7)	SHC	23,100	22,740	22,370	22,120	20,050	16,500
	84 (28.9)	SHC	25,430	25,060	24,690	24,450	22,370	17,560
	88 (31.1)	SHC	27,750	27,510	27,020	26,770	24,690	17,560
67 (19.4)		TC	32,420	31,780	31,050	# 30,600	25,550	17,760
	72 (22.2)	SHC	15,150	14,790	14,420	14,300	12,100	8,920
	76 (24.4)	SHC	17,480	17,110	16,870	16,620	14,420	11,240
	80 (26.7)	SHC	19,920	19,560	19,310	19,070	16,870	13,690
	84 (28.9)	SHC	22,250	22,000	21,640	21,390	19,190	16,010
	88 (31.1)	SHC	24,570	24,330	23,960	23,710	21,510	17,760
71 (21.7)		TC	33,130	32,540	31,840	31,490	25,710	17,880
	72 (22.2)	SHC	11,730	11,480	11,120	11,000	8,670	5,860
	76 (24.4)	SHC	14,050	13,810	13,440	13,320	11,120	8,310
	80 (26.7)	SHC	16,500	16,250	15,890	15,770	13,560	10,750
	84 (28.9)	SHC	18,820	18,580	18,330	18,210	15,890	13,070
	88 (31.1)	SHC	21,150	20,900	20,660	20,530	18,210	15,400
75 (23.9)		TC	33,630	33,090	32,430	32,190	25,730	17,900
	76 (24.4)	SHC	10,750	10,510	10,260	10,140	7,940	5,370
	80 (26.7)	SHC	13,200	12,950	12,710	12,590	10,380	7,820
	84 (28.9)	SHC	15,520	15,280	15,030	15,030	12,710	10,140
	88 (31.1)	SHC	17,840	17,720	17,480	17,360	15,030	12,590

TC : Total Cooling Capacity (BTU/h) SHC : Sensible Heat Capacity (BTU/h)

NOTE

- Rating conditions (#) : Indoor Unit Entering Air Temp. 80 °F (26.7 °C) DB / 67 °F (19.4 °C) WB
: Outdoor Ambient Temp. 95 °F (35 °C) DB
- Above data does not take Freeze Prevention Protection during cooling operation into account.
For this reason, the value may vary from the actual cooling characteristics.
- Above data represents the value when the operation frequency of a compressor is fixed.

Indoor Unit : **CS-KE36NKU**
 Outdoor Unit : **CU-KE36NKU**
 Power Supply : 230V Single Phase 60Hz

< Cooling Capacity >

RATING CAPACITY:		34,000 BTU/h		AIR FLOW RATE:		630 CFM		
INDOOR		OUTDOOR						
ENT. TEMP. °F (°C)		AMBIENT TEMP. °F (°C)						
WB	DB		65 (18.3)	75 (23.9)	85 (29.4)	95 (35.0)	105 (40.6)	115 (46.1)
59 (15.0)		TC	27,450	28,140	28,840	29,040	24,650	16,770
	72 (22.2)	SHC	19,680	20,050	20,410	20,530	18,210	14,420
	76 (24.4)	SHC	22,000	22,370	22,740	22,860	20,530	16,740
	80 (26.7)	SHC	24,450	24,820	25,180	25,300	22,980	16,770
	84 (28.9)	SHC	26,770	27,140	27,510	27,630	24,650	16,770
	88 (31.1)	SHC	27,450	28,140	28,840	29,040	24,650	16,770
63 (17.2)		TC	35,010	34,360	33,600	33,100	24,850	16,910
	72 (22.2)	SHC	20,170	19,800	19,310	19,070	15,030	11,480
	76 (24.4)	SHC	22,490	22,120	21,760	21,390	17,360	13,810
	80 (26.7)	SHC	24,940	24,570	24,200	23,840	19,800	16,250
	84 (28.9)	SHC	27,260	26,890	26,530	26,280	22,120	16,910
	88 (31.1)	SHC	29,580	29,220	28,850	28,610	24,450	16,910
67 (19.4)		TC	35,720	35,120	34,400	# 34,000	24,930	16,970
	72 (22.2)	SHC	16,620	16,380	16,010	15,890	11,730	8,670
	76 (24.4)	SHC	19,070	18,700	18,330	18,210	14,180	11,000
	80 (26.7)	SHC	21,510	21,150	20,900	20,660	16,620	13,440
	84 (28.9)	SHC	23,840	23,590	23,230	22,980	18,940	15,770
	88 (31.1)	SHC	26,160	25,920	25,550	25,300	21,270	16,970
71 (21.7)		TC	36,270	35,710	35,040	34,780	24,870	16,950
	72 (22.2)	SHC	13,070	12,830	12,460	12,340	8,430	5,610
	76 (24.4)	SHC	15,400	15,150	14,790	14,790	10,750	7,940
	80 (26.7)	SHC	17,840	17,600	17,360	17,230	13,200	10,380
	84 (28.9)	SHC	20,170	19,920	19,680	19,560	15,520	12,710
	88 (31.1)	SHC	22,490	22,250	22,000	21,880	17,840	15,030
75 (23.9)		TC	36,560	36,070	35,450	34,630	24,680	16,830
	76 (24.4)	SHC	11,850	11,610	11,360	11,120	7,570	5,130
	80 (26.7)	SHC	14,300	14,050	13,810	13,560	10,020	7,570
	84 (28.9)	SHC	16,620	16,500	16,250	15,890	12,340	9,900
	88 (31.1)	SHC	18,940	18,820	18,580	18,210	14,660	12,220

TC : Total Cooling Capacity (BTU/h) SHC : Sensible Heat Capacity (BTU/h)

NOTE

- Rating conditions (#) : Indoor Unit Entering Air Temp. 80 °F (26.7 °C) DB / 67 °F (19.4 °C) WB
 : Outdoor Ambient Temp. 95 °F (35 °C) DB
- Above data does not take Freeze Prevention Protection during cooling operation into account.
 For this reason, the value may vary from the actual cooling characteristics.
- Above data represents the value when the operation frequency of a compressor is fixed.

5-3. Cooling Capacity (Low Ambient)

Indoor Unit : **CS-KE30NKU**

Outdoor Unit : **CU-KE30NKU**

Power Supply : 230V Single Phase 60Hz

< Cooling Capacity (Low Ambient) >

RATING CAPACITY: 30,600 BTU/h			AIR FLOW RATE: 630 CFM						
INDOOR		OUTDOOR							
ENT. TEMP. °F (°C)		AMBIENT TEMP. °F (°C)							
WB	DB		0 (-17.8)	5 (-15.0)	15 (-9.4)	25 (-3.9)	35 (1.7)	45 (7.2)	55 (12.8)
59 (15.0)		TC	30,120	30,060	29,930	29,780	29,590	29,330	29,070
	72 (22.2)	SHC	21,150	21,150	21,020	23,230	20,780	20,660	20,530
	76 (24.4)	SHC	23,470	23,470	23,350	25,550	23,230	22,980	22,860
	80 (26.7)	SHC	25,920	25,920	25,790	27,870	25,670	25,430	25,300
	84 (28.9)	SHC	28,240	28,240	28,120	29,780	27,990	27,870	27,630
	88 (31.1)	SHC	30,120	30,060	29,930	29,780	29,590	29,330	29,070
63 (17.2)		TC	30,390	30,360	30,270	30,170	30,040	29,820	29,610
	72 (22.2)	SHC	17,720	17,720	17,600	23,230	17,480	17,360	17,360
	76 (24.4)	SHC	20,050	20,050	19,920	25,550	19,800	19,800	19,680
	80 (26.7)	SHC	22,490	22,490	22,370	27,870	22,370	22,250	22,120
	84 (28.9)	SHC	24,820	24,820	24,820	30,170	24,690	24,570	24,450
	88 (31.1)	SHC	27,140	27,140	27,140	30,170	27,020	26,890	26,770
67 (19.4)		TC	30,490	30,480	30,450	30,400	30,330	30,160	30,020
	72 (22.2)	SHC	14,180	14,180	14,180	23,230	14,180	14,050	14,050
	76 (24.4)	SHC	16,500	16,500	16,500	25,550	16,500	16,380	16,380
	80 (26.7)	SHC	19,070	18,940	18,940	27,870	18,940	18,820	18,820
	84 (28.9)	SHC	21,390	21,390	21,390	30,200	21,270	21,150	21,150
	88 (31.1)	SHC	23,710	23,710	23,710	30,400	23,590	23,590	23,470
71 (21.7)		TC	30,370	30,380	30,410	30,430	30,420	30,310	30,250
	72 (22.2)	SHC	10,510	10,510	10,510	23,230	10,630	10,510	10,510
	76 (24.4)	SHC	12,950	12,950	12,950	25,550	12,950	12,830	12,830
	80 (26.7)	SHC	15,400	15,400	15,400	27,870	15,400	15,280	15,280
	84 (28.9)	SHC	17,720	17,720	17,720	30,200	17,720	17,720	17,600
	88 (31.1)	SHC	20,050	20,050	20,050	30,430	20,050	20,050	20,050
75 (23.9)		TC	30,030	30,080	30,170	30,240	30,310	30,250	30,270
	76 (24.4)	SHC	9,410	9,410	9,410	25,550	9,530	9,530	9,530
	80 (26.7)	SHC	11,850	11,850	11,850	27,870	11,970	11,970	11,970
	84 (28.9)	SHC	14,180	14,180	14,300	30,200	14,300	14,300	14,300
	88 (31.1)	SHC	16,500	16,620	16,620	30,240	16,620	16,620	16,620

TC : Total Cooling Capacity (BTU/h) SHC : Sensible Heat Capacity (BTU/h)

NOTE

- Above data does not take Freeze Prevention Protection during cooling operation into account. For this reason, the value may vary from the actual cooling characteristics.
- Above data represents the value when the operation frequency of a compressor is fixed.

Indoor Unit : **CS-KE36NKU**
 Outdoor Unit : **CU-KE36NKU**
 Power Supply : 230V Single Phase 60Hz

< Cooling Capacity (Low Ambient) >

RATING CAPACITY:		34,000 BTU/h		AIR FLOW RATE:		630 CFM			
INDOOR		OUTDOOR							
ENT. TEMP. °F (°C)		AMBIENT TEMP. °F (°C)							
WB	DB		0 (-17.8)	5 (-15.0)	15 (-9.4)	25 (-3.9)	35 (1.7)	45 (7.2)	55 (12.8)
59 (15.0)		TC	30,900	30,870	30,800	30,710	30,590	30,400	30,210
	72 (22.2)	SHC	21,510	21,510	21,510	23,230	21,390	21,270	21,150
	76 (24.4)	SHC	23,960	23,840	23,840	25,550	23,710	23,590	23,470
	80 (26.7)	SHC	26,400	26,400	26,280	27,870	26,160	26,040	25,920
	84 (28.9)	SHC	28,730	28,730	28,610	30,200	28,480	28,480	28,360
	88 (31.1)	SHC	30,900	30,870	30,800	30,710	30,590	30,400	30,210
63 (17.2)		TC	31,010	31,010	30,990	30,950	30,890	30,750	30,620
	72 (22.2)	SHC	17,970	17,970	17,970	23,230	17,970	17,840	17,840
	76 (24.4)	SHC	20,410	20,410	20,290	25,550	20,290	20,170	20,170
	80 (26.7)	SHC	22,860	22,860	22,740	27,870	22,740	22,610	22,610
	84 (28.9)	SHC	25,180	25,180	25,180	30,200	25,060	25,060	24,940
	88 (31.1)	SHC	27,510	27,510	27,510	30,950	27,380	27,380	27,260
67 (19.4)		TC	30,910	30,940	30,980	31,000	31,010	30,930	30,880
	72 (22.2)	SHC	14,420	14,420	14,420	23,230	14,420	14,420	14,420
	76 (24.4)	SHC	16,740	16,740	16,740	25,550	16,740	16,740	16,740
	80 (26.7)	SHC	19,190	19,190	19,190	27,870	19,190	19,190	19,190
	84 (28.9)	SHC	21,510	21,510	21,640	30,200	21,640	21,510	21,510
	88 (31.1)	SHC	23,840	23,960	23,960	31,000	23,960	23,960	23,840
71 (21.7)		TC	30,570	30,620	30,730	30,820	30,910	30,900	30,930
	72 (22.2)	SHC	10,630	10,630	10,750	23,230	10,750	10,750	10,750
	76 (24.4)	SHC	12,950	12,950	13,070	25,550	13,070	13,070	13,070
	80 (26.7)	SHC	15,400	15,400	15,520	27,870	15,520	15,520	15,520
	84 (28.9)	SHC	17,720	17,840	17,840	30,200	17,970	17,970	17,970
	88 (31.1)	SHC	20,170	20,170	20,170	30,820	20,290	20,290	20,290
75 (23.9)		TC	30,010	30,090	30,260	30,430	30,590	30,650	30,770
	76 (24.4)	SHC	9,410	9,410	9,530	25,550	9,650	9,650	9,650
	80 (26.7)	SHC	11,850	11,850	11,970	27,870	12,100	12,100	12,100
	84 (28.9)	SHC	14,180	14,180	14,300	30,200	14,420	14,420	14,420
	88 (31.1)	SHC	16,500	16,620	16,620	30,430	16,740	16,740	16,870

TC : Total Cooling Capacity (BTU/h) SHC : Sensible Heat Capacity (BTU/h)

NOTE

- Above data does not take Freeze Prevention Protection during cooling operation into account. For this reason, the value may vary from the actual cooling characteristics.
- Above data represents the value when the operation frequency of a compressor is fixed.

5-4. Heating Capacity

Indoor Unit : **CS-KE30NKU**

Outdoor Unit : **CU-KE30NKU**

Power Supply : 230V Single Phase 60Hz

< Heating Capacity >

RATING CAPACITY:		33,000 BTU/h		AIR FLOW RATE:		671 CFM	
OUTDOOR		INDOOR					
ENT. TEMP. °F (°C)		AMBIENT TEMP. °F (°C)					
WB		60 (15.6)	65 (18.3)	70 (21.1)	75 (23.9)	80 (26.7)	
0 (-17.8)	TH	18,060	18,120	18,170	18,210	18,240	
3 (-16.1)	TH	18,670	18,730	18,780	18,820	18,850	
8 (-13.3)	TH	20,120	20,190	20,240	20,280	20,320	
13 (-10.6)	TH	21,640	21,710	21,770	21,810	21,840	
18 (-7.8)	TH	23,320	23,390	23,450	23,500	23,530	
23 (-5.0)	TH	25,100	25,170	25,230	25,280	25,310	
28 (-2.2)	TH	26,960	27,030	27,090	27,140	27,160	
33 (0.6)	TH	28,900	28,970	29,030	29,070	29,090	
38 (3.3)	TH	30,830	30,900	30,950	30,990	30,500	
43 (6.1)	TH	32,880	32,950	# 33,000	33,030	30,830	
48 (8.9)	TH	34,980	35,050	35,090	35,120	31,060	
53 (11.7)	TH	37,120	37,180	37,220	35,450	31,180	
58 (14.4)	TH	39,210	39,260	38,650	35,450	31,180	
63 (17.2)	TH	41,380	41,410	38,650	35,340	31,050	
65 (18.3)	TH	42,230	41,840	38,650	35,250	30,960	

TH : Total Heating Capacity (BTU/h)

NOTE

- Rating conditions (#) : Indoor Unit Entering Air Temp. 70 °F (21.1 °C) DB
: Outdoor Ambient Temp. 47 °F (8.3 °C) DB / 43 °F (6.1 °C) WB
- Above data does not take Defrost Operation, Overload Prevention Protection, and/or Cold Air Prevention Protection during heating operation into account. For this reason, the value may vary from the actual heating characteristics.
- Above data represents the value when the operation frequency of a compressor is fixed.

Indoor Unit : **CS-KE36NKU**
 Outdoor Unit : **CU-KE36NKU**
 Power Supply : 230V Single Phase 60Hz

< Heating Capacity >

RATING CAPACITY:		36,000 BTU/h		AIR FLOW RATE:		671 CFM	
OUTDOOR		INDOOR					
ENT. TEMP. °F (°C)		AMBIENT TEMP. °F (°C)					
WB		60 (15.6)	65 (18.3)	70 (21.1)	75 (23.9)	80 (26.7)	
0 (-17.8)	TH	19,760	19,860	19,940	20,010	20,080	
3 (-16.1)	TH	20,420	20,510	20,600	20,670	20,740	
8 (-13.3)	TH	21,990	22,090	22,180	22,260	22,330	
13 (-10.6)	TH	23,630	23,730	23,830	23,920	23,990	
18 (-7.8)	TH	25,440	25,560	25,660	25,750	25,820	
23 (-5.0)	TH	27,360	27,480	27,590	27,680	27,140	
28 (-2.2)	TH	29,370	29,490	29,600	29,700	27,580	
33 (0.6)	TH	31,460	31,590	31,700	31,560	27,940	
38 (3.3)	TH	33,540	33,670	33,780	31,900	28,210	
43 (6.1)	TH	35,760	35,890	# 36,000	32,150	28,410	
48 (8.9)	TH	38,030	38,160	36,450	32,300	28,520	
53 (11.7)	TH	40,340	40,460	36,500	32,330	28,530	
58 (14.4)	TH	42,580	41,040	36,420	32,230	28,430	
63 (17.2)	TH	44,920	40,770	36,160	32,000	28,210	
65 (18.3)	TH	44,920	40,610	36,020	31,870	28,090	

TH : Total Heating Capacity (BTU/h)

NOTE

1. Rating conditions (#) : Indoor Unit Entering Air Temp. 70 °F (21.1 °C) DB
 : Outdoor Ambient Temp. 47 °F (8.3 °C) DB / 43 °F (6.1 °C) WB
2. Above data does not take Defrost Operation, Overload Prevention Protection, and/or Cold Air Prevention Protection during heating operation into account. For this reason, the value may vary from the actual heating characteristics.
3. Above data represents the value when the operation frequency of a compressor is fixed.

5-5. Air Throw Distance Charts

Indoor Unit **CS-KE30NKU**

Cooling Room air temp.:80°F (26.7°C)
Fan speed:High

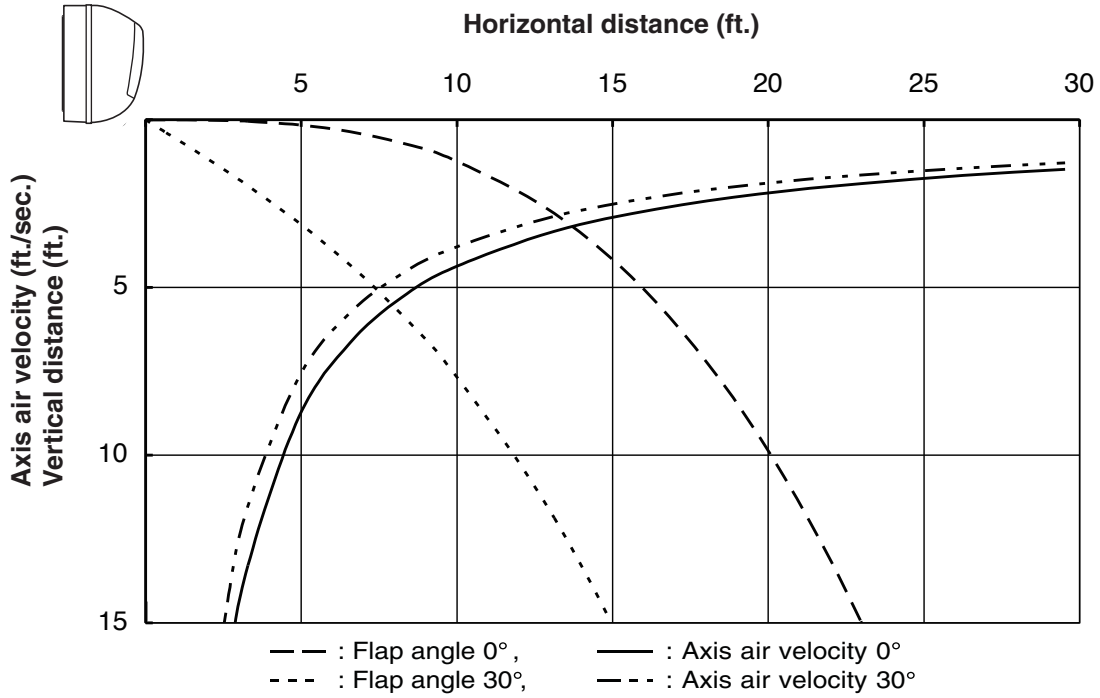

Heating Room air temp.:70°F (21.1°C)
Fan speed:High

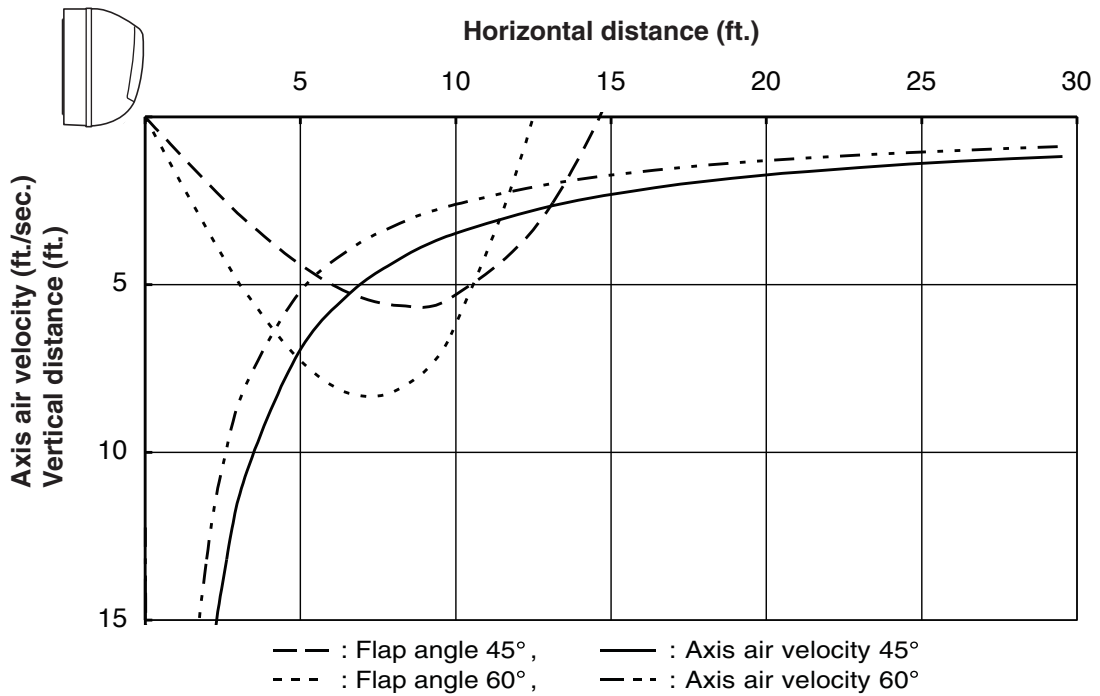

Cooling Room air temp.:80°F (26.7°C)
Fan speed:High

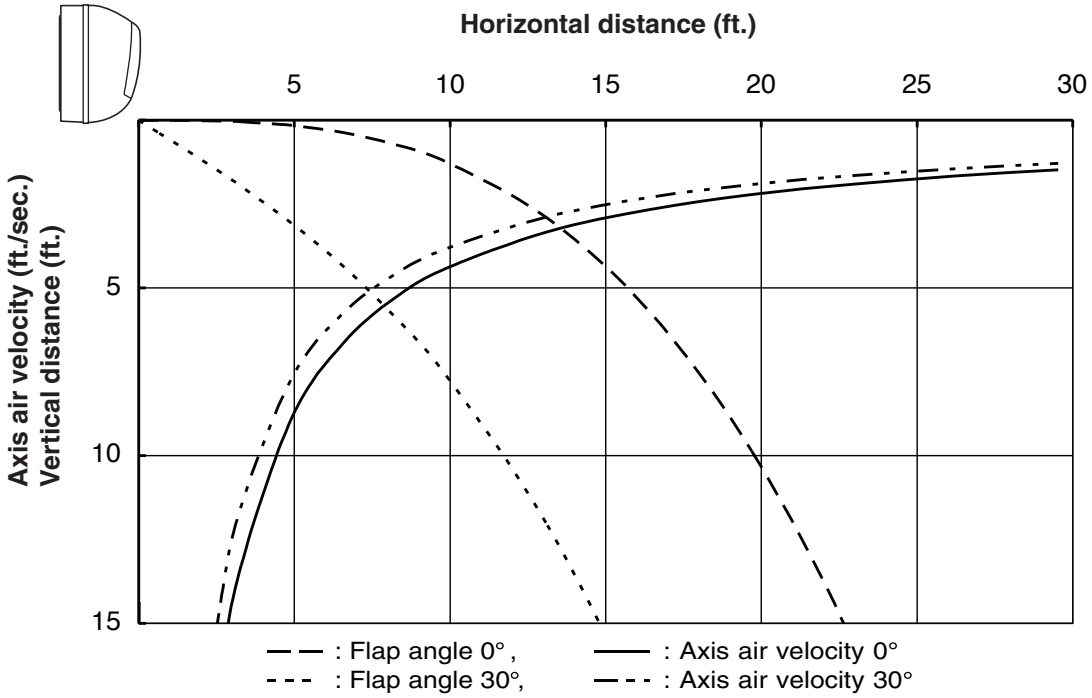

Heating Room air temp.:70°F (21.1°C)
Fan speed:High

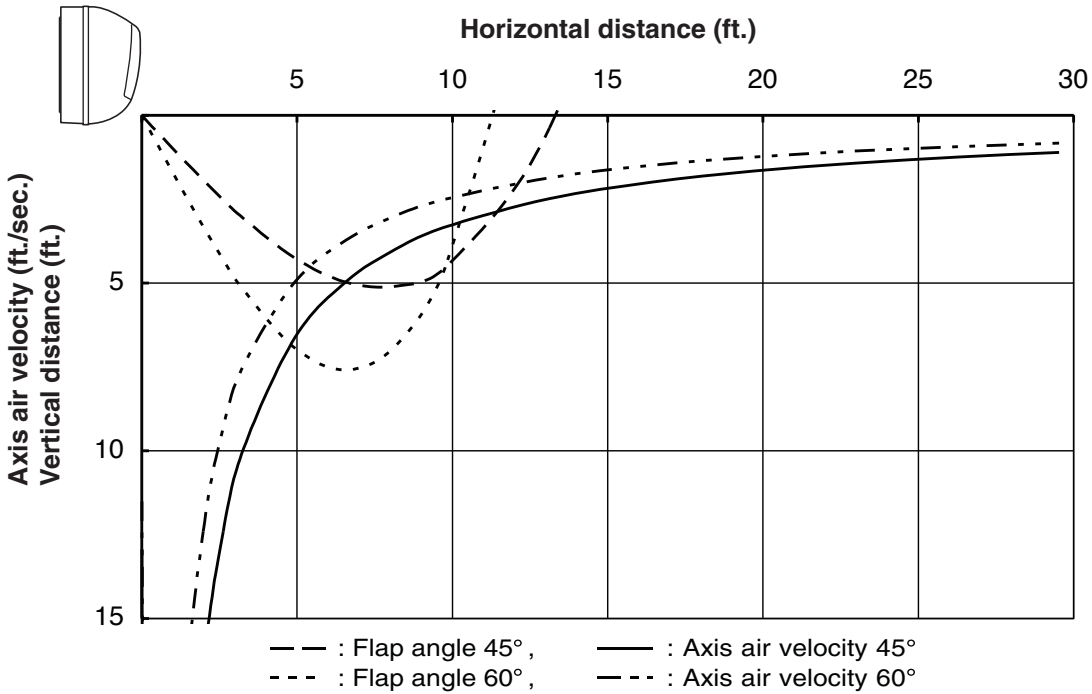

6. ELECTRICAL DATA

6-1. Electrical Characteristics

Indoor Unit **CS-KE30NKU**

Outdoor Unit **CU-KE30NKU**

(1) Voltage:230V

Cooling

< 230V >

			Indoor	UnitOutdoor Unit	Complete Unit
			Fan Motor	Fan Motor + Compressor	
Performance at			230V Single-phase 60Hz		
Rating conditions	Running amp.	A	0.4	16.1	16.5
	Power input	W	39	3,251	3,290

Rating conditions: Indoor air temperature: 80 °F (26.7 °C) DB / 67 °F (19.4 °C) WB
 Outdoor air temperature: 95 °F (35 °C) DB

Heating

			Indoor	UnitOutdoor Unit	Complete Unit
			Fan Motor	Fan Motor + Compressor	
Performance at			230V Single-phase 60Hz		
Rating conditions	Running amp.	A	0.5	14.8	15.3
	Power input	W	43	3,027	3,070

Rating conditions: Indoor air temperature 70 °F (21.1 °C) DB
 Outdoor air temperature 47 °F (8.3 °C) DB / 43 °F (6.1 °C) WB

(2) Voltage:208V

Cooling

< 208V >

			Indoor	UnitOutdoor Unit	Complete Unit
			Fan Motor	Fan Motor + Compressor	
Performance at			208V Single-phase 60Hz		
Rating conditions	Running amp.	A	0.4	17.6	18.0
	Power input	W	39	3,251	3,290

Rating conditions: Indoor air temperature: 80 °F (26.7 °C) DB / 67 °F (19.4 °C) WB
 Outdoor air temperature: 95 °F (35 °C) DB

Heating

			Indoor	UnitOutdoor Unit	Complete Unit
			Fan Motor	Fan Motor + Compressor	
Performance at			208V Single-phase 60Hz		
Rating conditions	Running amp.	A	0.5	16.3	16.8
	Power input	W	43	3,027	3,070

Rating conditions: Indoor air temperature 70 °F (21.1 °C) DB
 Outdoor air temperature 47 °F (8.3 °C) DB / 43 °F (6.1 °C) WB

Indoor Unit **CS-KE36NKU**

Outdoor Unit **CU-KE36NKU**

(1) Voltage:230V

Cooling

< 230V >

			Indoor	UnitOutdoor Unit	Complete Unit
			Fan Motor	Fan Motor + Compressor	
Performance at			230V Single-phase 60Hz		
Rating conditions	Running amp.	A	0.4	19.6	20.0
	Power input	W	39	3,961	4,000

Rating conditions: Indoor air temperature: 80 °F (26.7 °C) DB / 67 °F (19.4 °C) WB
 Outdoor air temperature: 95 °F (35 °C) DB

Heating

			Indoor	UnitOutdoor Unit	Complete Unit
			Fan Motor	Fan Motor + Compressor	
Performance at			230V Single-phase 60Hz		
Rating conditions	Running amp.	A	0.5	17.7	18.2
	Power input	W	43	3,607	3,650

Rating conditions: Indoor air temperature 70 °F (21.1 °C) DB
 Outdoor air temperature 47 °F (8.3 °C) DB / 43 °F (6.1 °C) WB

(2) Voltage:208V

Cooling

< 208V >

			Indoor	UnitOutdoor Unit	Complete Unit
			Fan Motor	Fan Motor + Compressor	
Performance at			208V Single-phase 60Hz		
Rating conditions	Running amp.	A	0.4	21.5	21.9
	Power input	W	39	3,961	4,000

Rating conditions: Indoor air temperature: 80 °F (26.7 °C) DB / 67 °F (19.4 °C) WB
 Outdoor air temperature: 95 °F (35 °C) DB

Heating

			Indoor	UnitOutdoor Unit	Complete Unit
			Fan Motor	Fan Motor + Compressor	
Performance at			208V Single-phase 60Hz		
Rating conditions	Running amp.	A	0.5	19.4	19.9
	Power input	W	43	3,607	3,650

Rating conditions: Indoor air temperature 70 °F (21.1 °C) DB
 Outdoor air temperature 47 °F (8.3 °C) DB / 43 °F (6.1 °C) WB

6-2. Electric Wiring Diagrams

Indoor Unit **CS-KE30NKU**
CS-KE36NKU

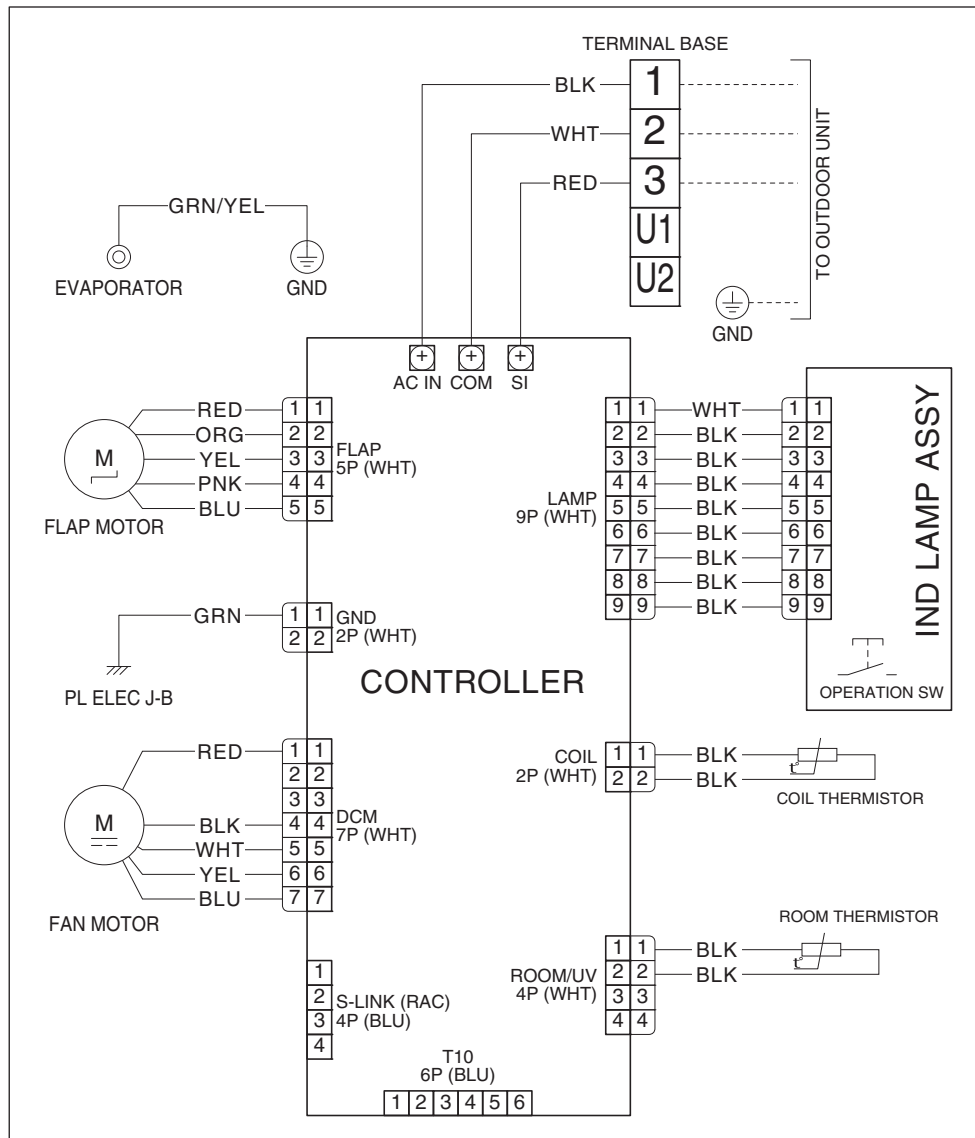

8FA2-5251-12400-1

Outdoor Unit **CU-KE30NKU**
CU-KE36NKU

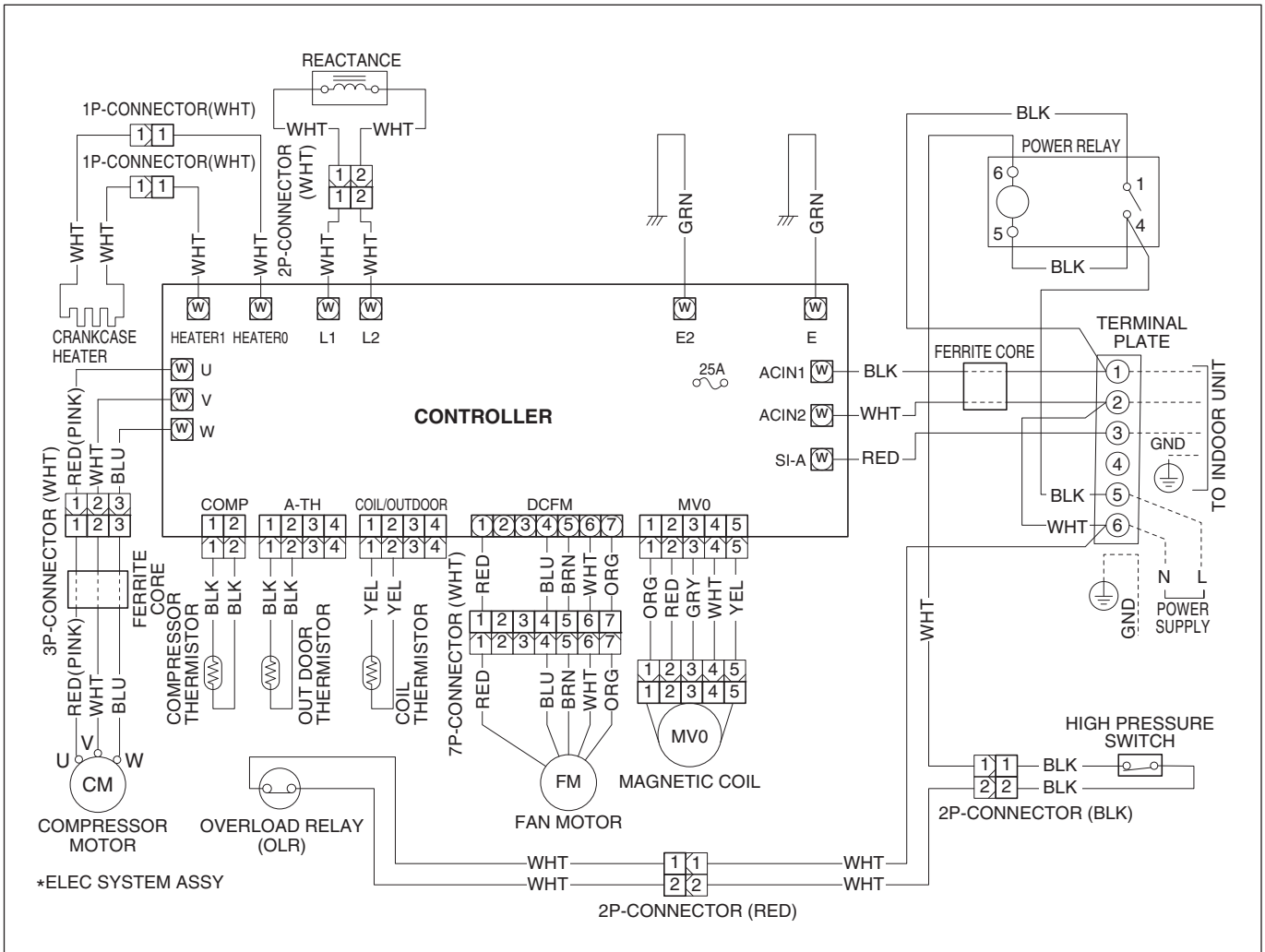

8FA2-5251-15200-0

7. FUNCTIONS

7-1. Operation Functions

■ Emergency operation

Emergency operation is available when the remote controller malfunctions, has been lost, or otherwise cannot be used.

To operate the system, press the OPERATION button, which is also used as the receiver, below the unit display. Each time this button is pressed, the OPERATION lamp changes color to indicate the type of operation. Select the desired type of operation.



- The set temperature is 4°F(2°C) below the detected room temperature in the case of cooling operation, and 4°F(2°C) above the room temperature in the case of heating operation. The flap and fan speed settings are AUTO.

■ AUTO cooling/heating operation

● Selecting the operation mode

- When AUTO mode is selected, the microprocessor calculates the difference between the set temperature and the room temperature, and automatically switches to Cooling or Heating mode.

Room temp. \geq Set temp. \rightarrow COOL
 Room temp. $<$ Set temp. \rightarrow HEAT

- As shown by the example in the figure below, with AUTO cooling/heating operation, the mode changes between Heating and Cooling mode according to changes in the relationship between the current room temperature and the set temperature.

Example

Example of operation in AUTO mode with the set room temperature at 74°F(23°C).

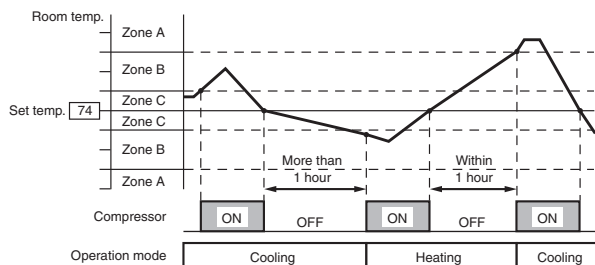

■ SENSOR DRY

During DRY operation, the system adjusts the room temperature and fan speed according to the conditions in the room, in order to maintain a comfortable room environment.

SENSOR DRY operation

- DRY operation is as shown in the figure below.

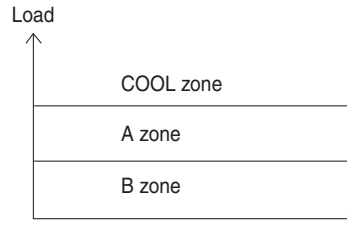

Conditions are monitored at all times when the room temperature is below 59°F(15°C).

DRY A

The compressor operation frequency varies.
 The indoor fan operates with 1/f fluctuation.

DRY B

The compressor operates at a low operating frequency.
 The indoor fan operates with 1/f fluctuation.

Monitor

- Monitoring operation takes place when the room temperature is below 59°F(15°C), or more than 5°F(3°C) below the set temperature.
- When the monitoring range is entered, the compressor stops, and the indoor fan operates with 1/f fluctuation.

NOTE

The Sensor Dry operation during the Low Ambient Cooling Mode (outside air temperature : 59°F(15°C) or lower) is as follows.

DRY A and DRY B

When room temperature rises above the set temperature, the compressor turns ON. When room temperature falls below the set temperature, the compressor turns OFF.

■ HIGH POWER

This function acts to raise the power but keeps the AC system in the same operating mode. This function is set with the HIGH POWER button on the remote controller.

(It can be set regardless of the temperature and fan speed settings.)

● HIGH POWER operation from remote controller

The unit operates at maximum output for 30 minutes, regardless of the desired temperature. The fan speed is 1 step above "High."

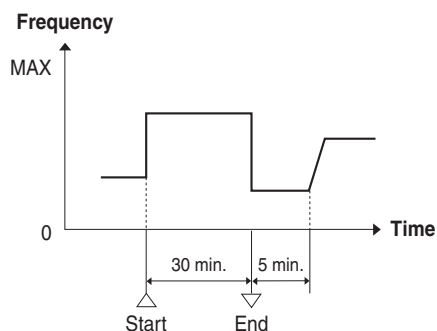

NOTE

- When HIGH POWER operation ends, the unit operates at low Hz for 5 minutes, regardless of the thermostat OFF conditions.
- When in DRY mode, operation is in the cooling zone.

■ Lamp colors

OPERATION lamp

HEAT operation	Red
DRY operation	Orange
COOL operation	Green
FAN operation	Green
DEFROSTING operation	Red and Orange alternately

TIMER lamp

Green

LED CLEAN lamp

Green

■ Timer backup

- Operation stops if there are no operator controls for 25 hours or longer after unit operation switched from OFF to ON by use of ON timer operation.

■ NIGHT SETBACK

- When NIGHT SETBACK operation is set, the temperature and fan speed settings will be adjusted automatically to allow comfortable sleep.
- When NIGHT SETBACK operation is set, "☺" mark appears on the remote controller. The main unit display lamp also becomes dimmer.

● COOL and DRY modes

When the night setback mode is selected, the air conditioner automatically raises the temperature setting $2^{\circ}\text{F}(1^{\circ}\text{C})$ when 30 minutes have passed after the selection was made, and then another $2^{\circ}\text{F}(1^{\circ}\text{C})$ after another 30 minutes have passed, regardless of the indoor temperature when night setback was selected. This enables you to save energy without sacrificing comfort. This function is convenient when gentle cooling is needed.

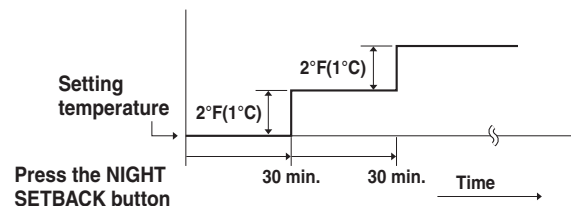

Press the NIGHT SETBACK button

● HEAT mode

When the night setback mode is selected, the air conditioner automatically lowers the temperature setting $4^{\circ}\text{F}(2^{\circ}\text{C})$ when 30 minutes have passed after the selection was made, and then another $4^{\circ}\text{F}(2^{\circ}\text{C})$ after another 30 minutes have passed, regardless of the indoor temperature when night setback was selected. This enables you to save energy without sacrificing comfort. This function is convenient when gentle heating is needed.

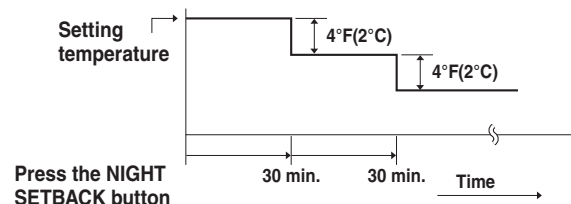

Press the NIGHT SETBACK button

■ Noise Reducing Control (Outdoor Unit)

The noise reducing control is the function used for silent operation of the air conditioner by means of setting the dip switch on the outdoor unit P.C.Board to control the fan and compressor's motor speed.

NOTE When this function is used, the cooling or heating ability is slightly degraded. Therefore, when this function is to be enabled, make sure to receive the approval of the client.

<Operation Sound>

Specifications		Noise Reducing Control (Fan's motor speed : 500rpm)	
Cooling	Heating	Cooling	Heating
55 dB-A	55 dB-A	47 dB-A	47 dB-A

<In Cooling Operation>		<In Heating Operation>	
Outdoor Air Temp. °F(°C)		Outdoor Air Temp. °F(°C)	
91(33)	Normal Operation	59(15)	Noise Reducing Operation
82(28)	Normal Operation or Noise Reducing Operation is kept. (Initial setting is the normal operation.)	50(10)	Normal Operation or Noise Reducing Operation is kept. (Initial setting is the normal operation.)
	Noise Reducing Operation		Normal Operation

- NOTE**
1. In the test operation, high-power operation, defrost operation or low ambient cooling operation (to be cancelled at the outside temperature of 57 °F(14 °C) or less, or 63 °F(17 °C) or more), the noise reducing control is not available.
 2. In the noise reducing operation, the fan's maximum motor speed is limited to 500rpm. Also, the maximum frequency (Hz) is controlled in the cooling (30Hz) or heating operation (30Hz).

<Switching Procedure to Noise Reducing Control>

- (1) Remove the 3 screws fixing the inspection panel and remove the inspection panel. (Fig. 2)
- (2) When the switch No. 1 of the dip switch (SW01) on the control P.C.Board is turned ON, the noise reducing control is enabled. (Fig. 3)

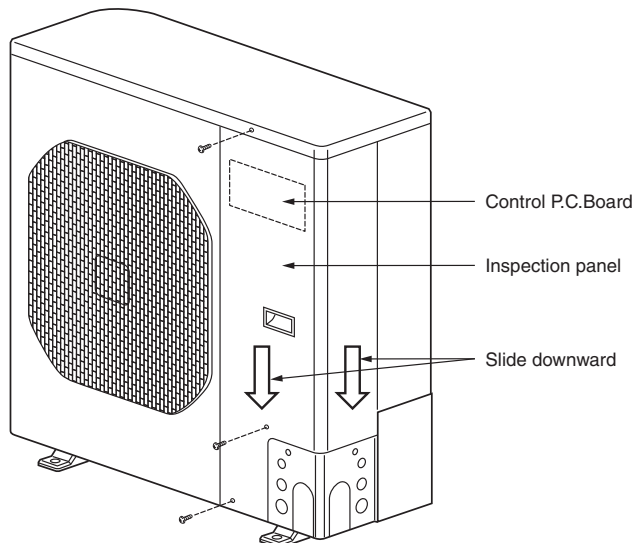

Fig.2 View from front

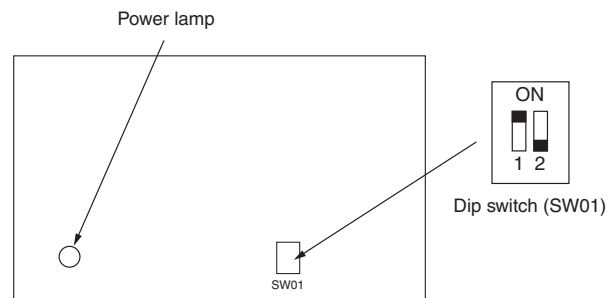

Fig.3 Control P.C.Board

Maximum Current Value Change Function

The maximum current value is changed to 14A (for CU-KE30NKU) or 17A (for CU-KE36NKU) to prevent power breaker tripping. (It is set to 24A (in cooling) or 22A (in heating) when the unit is delivered from the factory.)

- NOTE**
- When the high load is given (Outside temperature is high in the cooling operation, or outdoor temperature is low in the heating operation), the capacity is reduced. When the maximum current value change function is to be enabled, make sure to receive the approval of the client.
 - The maximum capacity for cooling or heating operation is about as much as the rated capacity.

Description of function

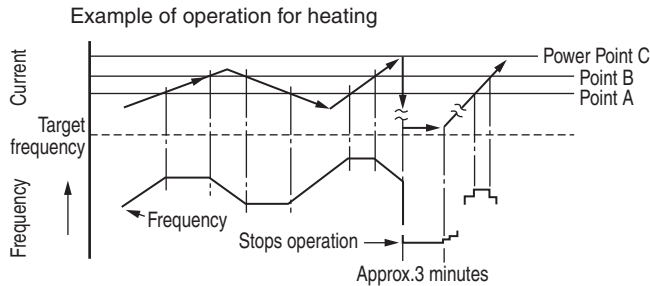

- Operates at the target frequency at Point A and below.
 - Stops increases to the frequency between Points A and B.
 - Reduces the frequency by 1 Hz per 0.5 seconds when Point B is exceeded.
 - Stops operation, and restarts it approximately 5 minutes later, if Point C is exceeded.
- (May operate when sudden voltage fluctuations occur. →Indicates trouble.)

< CU-KE30NKU >

	In cooling operation	In heating operation
Current Value on the Point C	(25.0)	(25.0)
Current Value on the Point B	22.0	22.0
Current Value on the Point A	21.6	21.6

< CU-KE36NKU >

	In cooling operation	In heating operation
Current Value on the Point C	(25.0)	(25.0)
Current Value on the Point B	24.0	23.5
Current Value on the Point A	23.6	23.1

<Maximum Current Value Change Procedure>

- Remove the inspection panel.
Refer to Fig. 2 in "Noise Reducing Control" for details.
- When the switch No.2 of the dip switch (SW01) on the control P.C.Board is turned ON, the maximum current value change. (Fig. 4)

Dip Switch (SW01) Switch No.2	Max. Current Value	
	CU-KE30NKU	CU-KE36NKU
ON	14.0A	17.0A
OFF	22.0A	24.0A

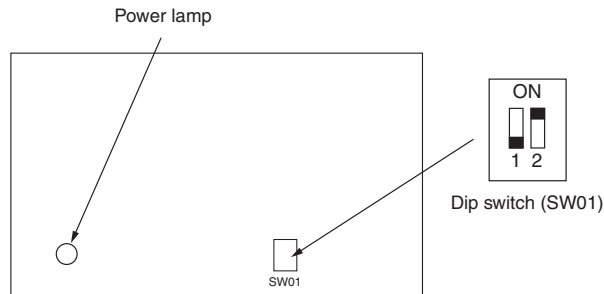
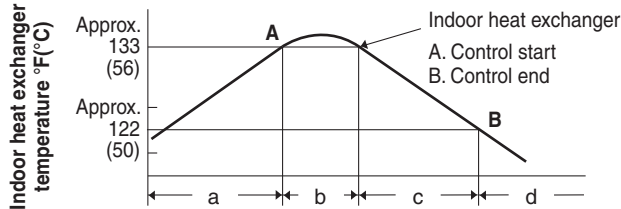

Fig.4 Control P.C.Board

7-2. Protective Functions

Overload prevention during heating

During HEAT operation, the temperature of the indoor heat exchanger is used to control the frequency and lessen the load on the compressor before the protective device is activated.



- Area: Automatic capacity control
- When Point A has been exceeded, the operation frequency is reduced by a certain proportion.
- Area: Frequency increase is prohibited.
- At Point B and below, overload prevention is ended and control is the same as in the a area.

Freeze prevention

During COOL or DRY operation, freezing is detected and operation is stopped when the temperature of the indoor heat exchanger matches the conditions below.

- Freeze-prevention operation is engaged when the temperature of the indoor heat exchanger is below 41°F(5°C).
- Restart after freeze-prevention operation occurs when the temperature of the indoor heat exchanger reaches 46°F(8°C) or above.

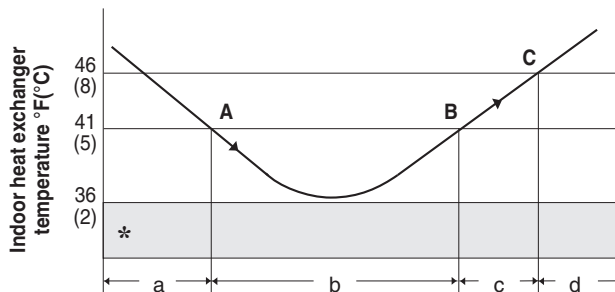

- Area: Automatic capacity control
 - When the temperature drops below Point A, the operation frequency is reduced by a certain proportion.
 - Area: Frequency increase is prohibited.
 - When the temperature reaches Point C or above, freezing prevention is ended and control is the same as in the a area.
- * When the temperature drops to below 36°F(2°C) (continuously for 2 minutes or longer), the compressor stops. Once the freeze condition is detected, the air conditioner will work less than the maximum frequency until it is turned off.

Cold-air prevention during heating

During heating, the fan speed is set to "LL" (very low) or stopped. As the temperature of the indoor heat exchanger rises, the fan speed is changed to the set speed.

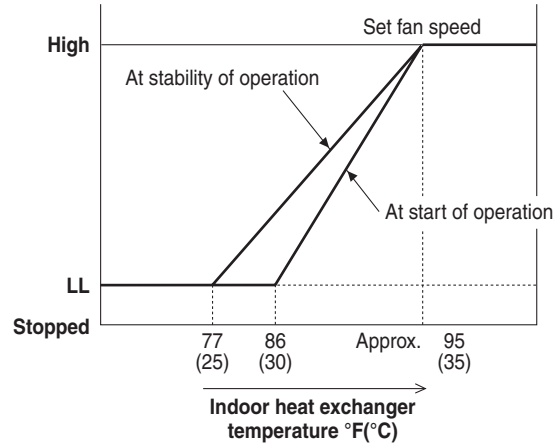

NOTE

- The fan speed is forcibly changed to "LL" beginning 30 seconds after the thermostat turns OFF.
- At stability of operation refers to operation when the room temperature has approached the set temperature.
- When HEAT operation starts, the indoor fan is stopped until the temperature of the indoor heat exchanger reaches 68°F(20°C) or higher, or until the room temperature reaches 59°F(15°C) or higher.

Compressor discharge temperature control

This function controls the operation frequency to prevent the compressor discharge temperature from rising more than a specified temperature.

Compressor discharge temperature °F(°C)

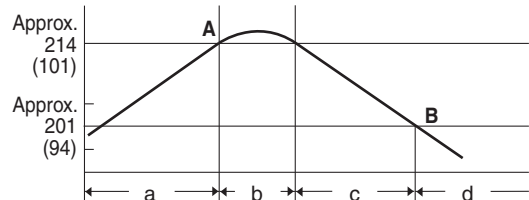

- Area: Automatic capacity control.
 - When the temperature rises above Point A, the operation frequency is reduced at a specified rate.
 - Area: Further frequency increase is prohibited.
 - When the temperature falls below Point B, prevention of a rise in frequency is released and the air conditioner operates as in a area.
- * The compressor will stop if the temperature of the compressor discharge exceeds 248°F(120°C) due to shortage of gas or other reason.

■ Defrost detection and release

● Reverse-Cycle Defrosting

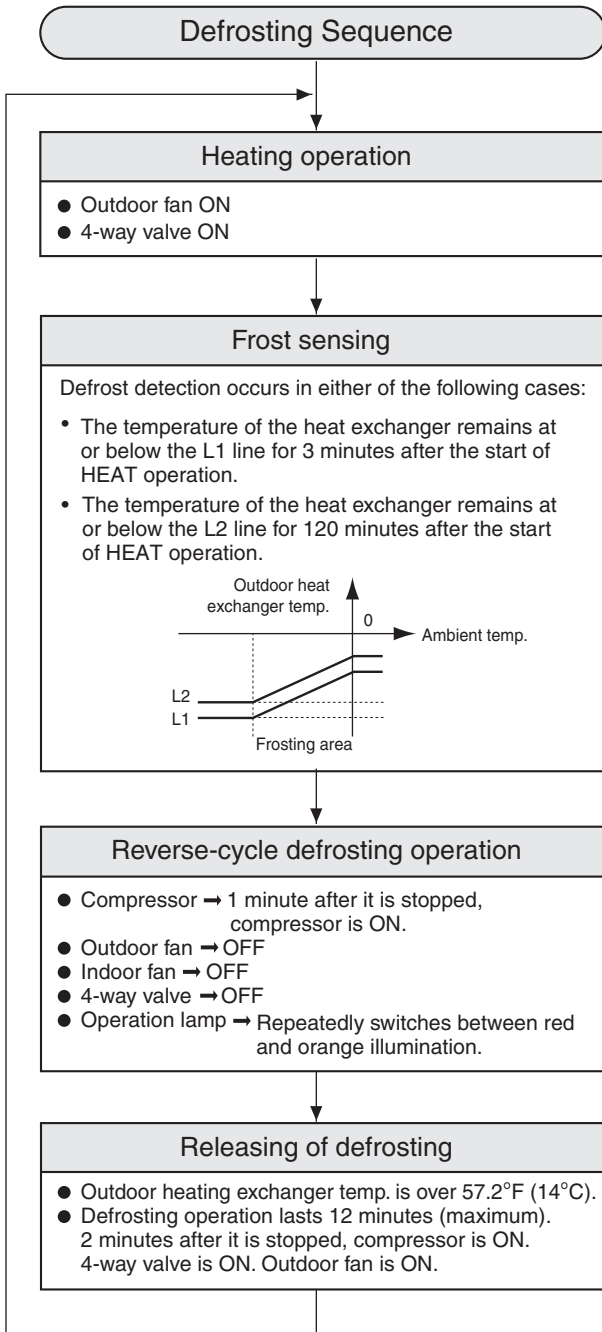

NOTE

If the air conditioner is turned off during the defrosting cycle, it will continue defrosting and turn itself off after defrosting is completed.

■ CT (Peak current cut-off control)

- This function prevents the circuit breaker or fuse from operating to open the circuit. This function works when electrical current has increased due to an increase in the cooling / heating load, or to a decrease in the power supply voltage. In these cases, operation frequency is reduced or operation is interrupted automatically to control the electrical current for operation.
- When the cause of the increase in electrical current is rectified, the system will resume operation in the original mode.

< CS-KE30NKU >

(A)

	Cooling • Dry	Heating
Peak current cut-off trips	25.0	
Hz down	22.0	

< CS-KE36NKU >

(A)

	Cooling • Dry	Heating
Peak current cut-off trips	25.0	
Hz down	24.0	23.5

NOTE

Electrical current setting for COOL operation is used during DEFROST operation.

8. TROUBLESHOOTING (BEFORE CALLING FOR SERVICE)

8-1. Precautions before Performing Inspection or Repair

- After checking the self-diagnostics monitor, turn the power OFF before starting inspection or repair.
- High-capacity electrolytic capacitors are used inside the outdoor unit controller (inverter). They retain an electrical charge (charging voltage DC 310V) even after the power is turned OFF, and some time is required for the charge to dissipate. Be careful not to touch any electrified parts before the controller LED (red) turns OFF.
If the outdoor controller is normal, approximately 30 seconds will be required for the charge to dissipate. However, allow at least 5 minutes for the charge to dissipate if there is thought to be any trouble with the outdoor controller.

8-2. Method of Self-Diagnostics

Follow the procedure below to perform detailed trouble diagnostics.

NOTE

- 1: If the operation lamp blinks every 0.5 seconds immediately when the power is turned ON, there is an external ROM (OTP data) failure on the indoor circuit board, or a ROM socket insertion problem, or the ROM has not been installed.
- 2: The failure mode is stored in memory even when the power is not ON. Follow the procedure below to perform diagnostics.

PROCEDURE

After turning on power to the air conditioner, use the remote controller and follow the steps below to execute self-diagnostics.

- Step 1: Press and hold the remote controller QUIET button and 1 HR TIMER button. Then, press and hold the ACL (reset) button with a pointed object such as the tip of a pen. After 5 seconds, release ACL button first, then release QUIET and 1 HR TIMER buttons, "oP-1" (test run) appears, blinking in the remote controller clock display area.
- Step 2: Next, press the 1 HR TIMER button twice to change the display from "oP-1" to "oP-2" and "oP-3" (self-diagnostics). (The display continues to blink.)
- Step 3: Finally press the ON/OFF button to engage self-diagnostics mode.

- The self-diagnostics function utilizes the 3 indicator lamps on the main unit, in combinations of ON lamps, blinking lamps, and OFF lamps, to report the existence of sensor trouble or a protective operation. (The lamps blink or remain ON for 5 seconds, then turn OFF for 2 seconds.) Self-diagnostics is completed when the buzzer sounds 3 short beeps.
- A maximum of 3 self-diagnostics reports are displayed, for 5 seconds each, beginning with the most recent report. Following this display the lamps turn OFF. In order to view the self-diagnostics results again, press the ON/OFF button again.
- The 3 lamps remain OFF if no trouble has occurred.

<IMPORTANT> After self-diagnostics is completed, be sure to press the ACL (reset) button to return to normal mode. The air conditioner will not operate if this is not done.

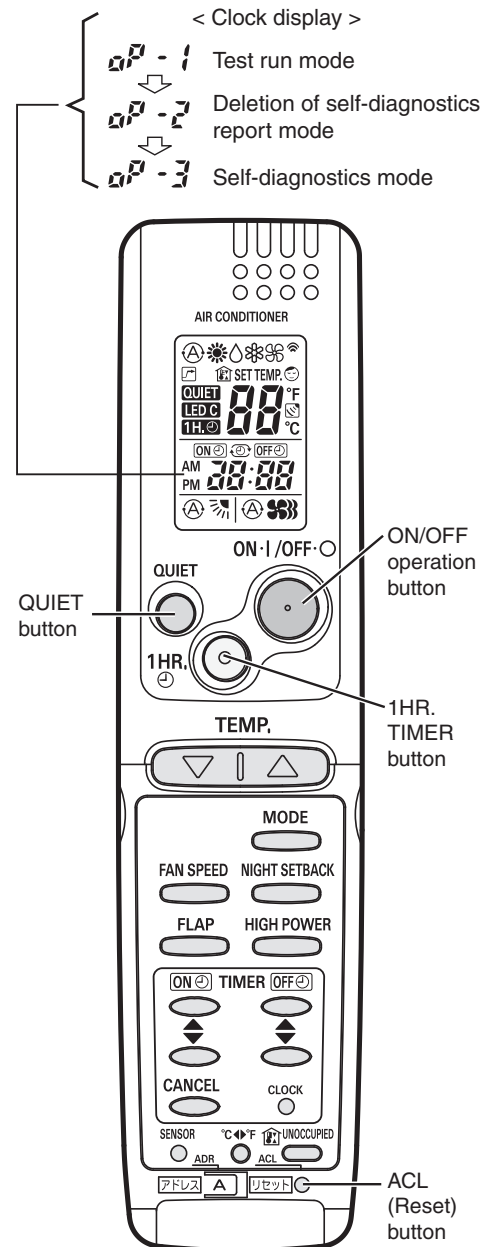

(1) Self-diagnostics Lamps

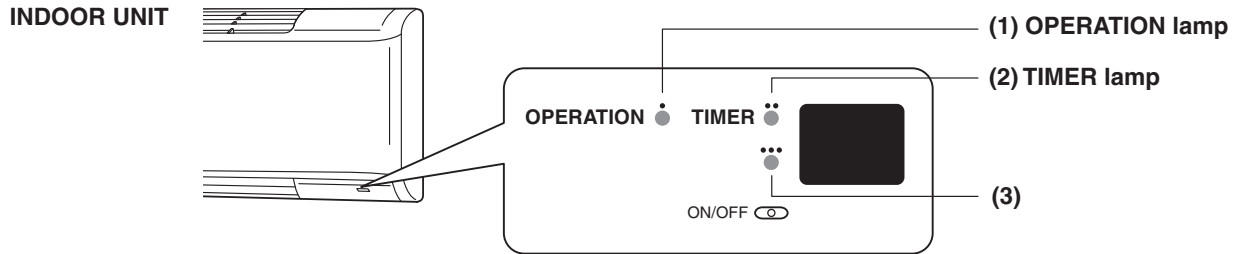

Since the indications cover various units, the corresponding parts listed below may not be present in some models.

INDICATION ON INDOOR UNIT					×	•	☀ OFF BLINKING ON
ALARM CODE	(3) ...	TIMER (2) ..	OPERATION (1) .	ERROE CODE	DIAGNOSIS CONTENTS	POSSIBLE MALFUNCTION				
F10	×	×	•	S01	ROOM TEMP. SENSOR TROUBLE	(1) OPEN OR SHORT CIRCUIT IN SENSOR (2) POOR CONTACT AT CONNECTOR OR OPEN CIRCUIT AT TERMINAL PRESS-FIT LOCATION (FOR HUMIDITY SENSOR, THIS REPRESENTS SHORT-CIRCUIT DETECTION ONLY.) (3) I/D PCB FAILURE (I/D = INDOOR)				
F02	×	•	×	S02	I/D HEAT EXCHANGER TEMP. SENSOR TROUBLE					
F13	×	•	•	S03	HUMIDITY SENSOR TROUBLE					
F04/F12	•	×	×	S04	COMPRESSOR TEMP. SENSOR TROUBLE	(1) OPEN OR SHORT CIRCUIT IN SENSOR (2) POOR CONTACT AT CONNECTOR OR OPEN CIRCUIT AT TERMINAL PRESS-FIT LOCATION (3) O/D PCB FAILURE (O/D = OUTDOOR)				
F09/F12-F18	•	×	•	S05	O/D HEAT EXCHANGER TEMP. SENSOR TROUBLE					
F08/F21-F24	•	•	×	S06	O/D AIR TEMP. SENSOR TROUBLE					
F27	•	•	•	S07	O/D CURRENT SENSOR ERROR	O/D PCB FAILURE				
E05	×	×	☀	E01	I/D-O/D COMMUNICATION TROUBLE (SERIAL COMMUNICATION TROUBLE)	(1) MIS-WIRING (2) AC POWER FAILURE (3) BLOWN FUSE (4) POWER RELAY FAILURE (5) I/D OR O/D PCB FAILURE (6) O/D FAN MOTOR FAILURE (7) REACTOR FAILURE (8) HIGH-PRESSURE SW FAILURE (9) OLR FAILURE (10) MAGNETIC COIL FAILURE				
P26	×	☀	×	E02	HIC CIRCUIT TROUBLE POWER TR CIRCUIT TROUBLE	(1) HIC OR POWER TR FAILURE (2) O/D FAN NOT OPERATING (3) INSTANTANEOUS POWER STOPPAGE (4) SERVICE VALVE NOT OPENED. (5) O/D FAN BLOCKED (6) CONTINUOUS OVERLOAD OPERATION (7) COMPRESSOR FAILURE (8) O/D PCB FAILURE				
F31	×	☀	☀	E03	O/D UNIT EXTERNAL ROM TROUBLE	(1) EXTERNAL ROM DATA FAILURE (2) O/D PCB FAILURE				
P16	☀	×	×	E04	CURRENT PEAK CUT	(1) INSTANTANEOUS POWER STOPPAGE (2) HIC OR POWER TR FAILURE (3) O/D PCB FAILURE				
P07	☀	×	☀	E05	PAM CIRCUIT TROUBLE ACTIVE CIRCUIT TROUBLE	(1) O/D PCB FAILURE (2) O/D POWER VOLTAGE TROUBLE				
P03	☀	☀	×	E06	COMPRESSOR DISCHARGE TEMP. OVERHEATING PREVENTION	(1) ELECTRIC EXPANSION VALVE FAILURE (2) CHOKED CAPILLARY TUBE (3) INSUFFICIENT GAS (4) CONTINUOUS OVERLOAD OPERATION (5) O/D FAN NOT OPERATING (6) O/D PCB FAILURE				
P01	☀	☀	☀	E07	I/D FAN OPERATION TROUBLE	(1) FAN MOTOR FAILURE (2) CONNECTOR CONTACT FAILURE (3) I/D PCB FAILURE				
P19	•	•	☀	E08	4-WAY VALVE SWITCHING TROUBLE ZERO-CROSS TROUBLE	(1) 4-WAY VALVE FAILURE (HEAT PUMP MODEL ONLY) (2) O/D PCB FAILURE				
P15	•	☀	•	E09	GAS-LOSS PREVENTION	(1) SERVICE VALVE NOT OPENED (2) INSUFFICIENT GAS				
P29	•	☀	☀	E10	DC COMPRESSOR DRIVE CIRCUIT TROUBLE	(1) OPEN PHASE (2) O/D PCB FAILURE				
P22	☀	•	•	E11	O/D DC FAN OPERATION TROUBLE	(1) FAN MOTOR FAILURE (2) CONNECTOR CONTACT FAILURE (3) O/D PCB FAILURE				
E07/P04/P05 P20/P27	☀	•	☀	E12	O/D SYSTEM COMM FAILURE, OLR OPERATION, O/D POWER OPEN PHASE, O/D FREEZING	(1) MIS-WIRING (2) BLOWN FUSE (3) POWER RELAY FAILURE (4) O/D PCB FAILURE (5) COMPRESSOR FAILURE				
P11	☀	☀	•	E13	FREEZING-PREVENTION OPERATION	(1) I/D FAN SYSTEM TROUBLE (2) INSUFFICIENT GAS (3) OPERATION AT LOW TEMPERATURE				

(2) If the self-diagnostics function fails to operate

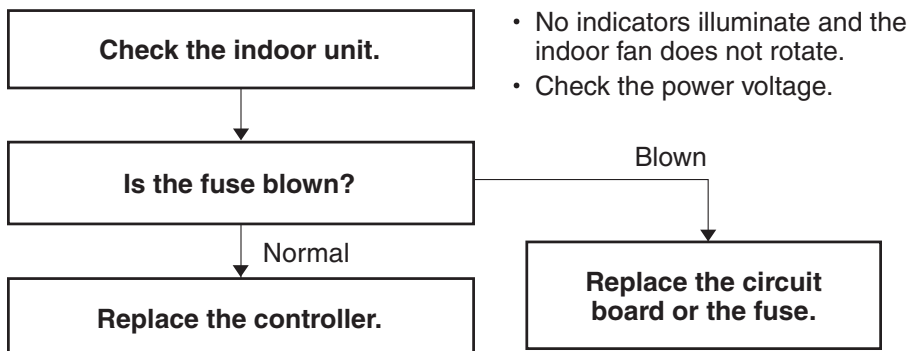

8-3. Checking the Indoor and Outdoor Units

(1) Checking the indoor unit

No.	Control	Check items (unit operation)
1	Use the remote controller to operate the unit in "TEST run" mode. To determine whether the mode is currently in "TEST run" mode, check the 4 indicator lamps on the unit. If all 4 are blinking, the current mode is "TEST run."	<ul style="list-style-type: none"> The rated voltage must be present between inter-unit wirings 1 and 2. Connect a 5 k ohm resistor between inter-unit wirings 2 and 3. When the voltage at both ends is measured, approximately 12 to 15V DC must be output and the multimeter pointer must bounce once every 8 seconds. Or instead of measuring the voltage, you can insert an LED jig and check that the LED flickers once every 8 seconds.

- If there are no problems with the above, then check the outdoor unit.
- For the "Test run" procedure, refer to the Appendix B "Installation Instructions".

(2) Checking the outdoor unit

No.	Control	Check items (unit operation)
1	Apply the rated voltage between outdoor unit terminals L and N.	<ul style="list-style-type: none"> The control panel LED (red) must illuminate.
2	Short-circuit the outdoor unit COM terminal to the T-RUN terminal.	<ul style="list-style-type: none"> The compressor, fan motor and 4-way valve must all turn on.

- If there are no problems with the above, then check the indoor unit.

● Using the TEST/T-RUN terminals

- T-RUN : Test run (compressor and fan motor turn ON).
 TEST/MV : Compresses time to 1/60th (accelerates operation by 60 times faster than normal).

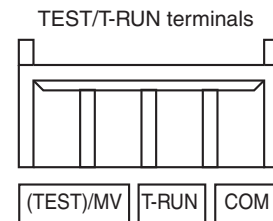

(3) Serial Communication Error Identification Procedure

If the lamps on the main body show the following conditions after the completion of self-diagnostics, a communication error between the indoor unit and outdoor unit might be considered. In such a case, identify the breakdown section by using the following procedure.

NOTE Refer to "Method of Self-Diagnostics" for the self-diagnostics procedure.

Alarm Code (Error Code)	Lamp (3) ...	Timer (2) ..	Operation (1) .	
E05 (E01)	×	×	☀	×
E07/P04/P05/P20/P27 (E12)	☀	⦿	☀	⦿
				☀

< Before the Operation >



WARNING

For terminal strip short circuit work or inter-unit wiring removal, turn off the power to avoid an electric shock. Release the terminal strip short circuit after the completion of self-diagnostics.



CAUTION

Do not perform the short-circuit work between any other terminals except for specified ones on the specified terminal strip. If such work is performed between the incorrect terminals, the unit might be broken.

< Convenient Tool for Short-Circuit Work (for example) >

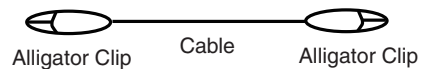

< Check Items before Troubleshooting Serial Communication Start >

After confirming that the following errors do not exist, start the "Troubleshooting Serial Communication" in "Alarm Code : E05 and E07/P04/P05/P20/P27".

- | | |
|---|--|
| 1. Mis -wiring (inter-unit cable, etc.) | 6. Reactor failure (defective insulation, etc.) |
| 2. AC power failure | 7. High-Pressure Switch failure |
| 3. Blown fuse | 8. Overload Relay failure |
| 4. Power Relay failure | 9. Magnetic Coil failure (defective insulation, short-circuit, etc.) |
| 5. Outdoor Fan Motor failure (defective insulation, etc.) | 10. Compressor failure (defective insulation, etc.) |

(3-1) Alarm Code : E05

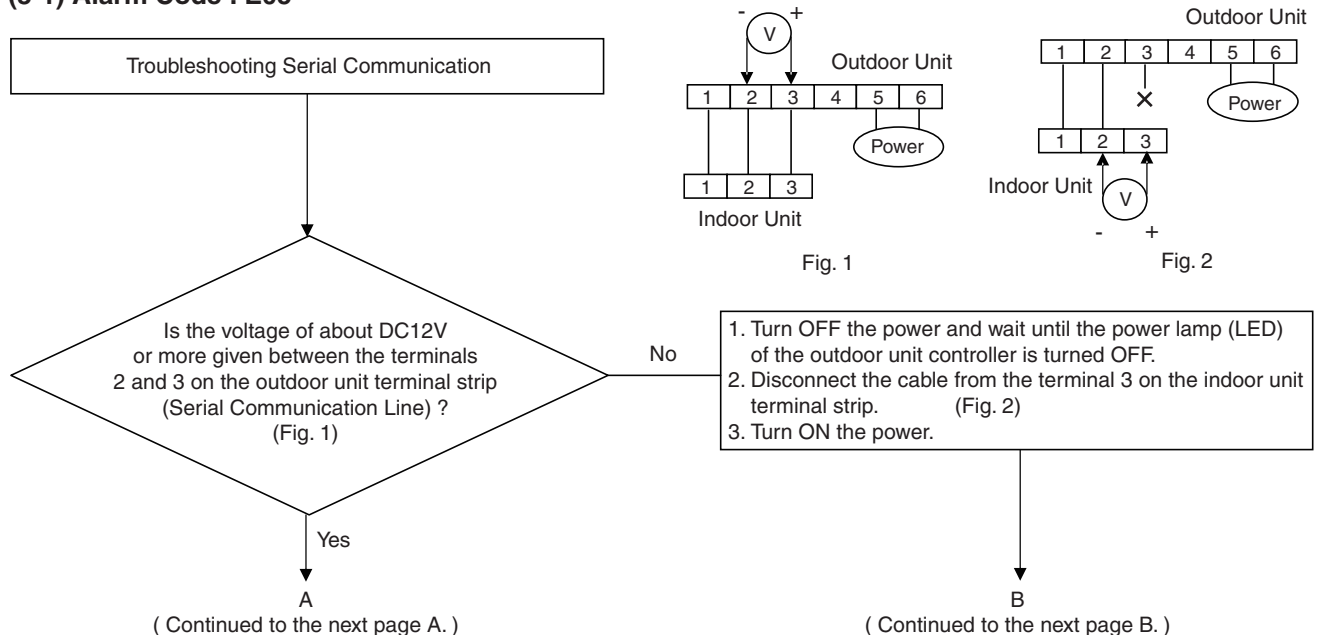

(Continued from the previous page A.)

(Continued from the previous page B.)

A

B

Yes

No

Defect or connection error in the inter-unit cable

Defect in the indoor unit P.C. board

1. Turn OFF the power and wait until the power lamp (LED) of the outdoor unit controller is turned OFF.
 2. Short-circuit between the terminals 2 and 3 on the outdoor unit terminal strip. (Fig. 3)

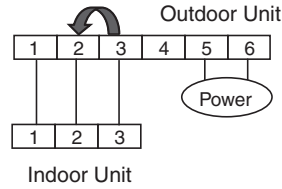
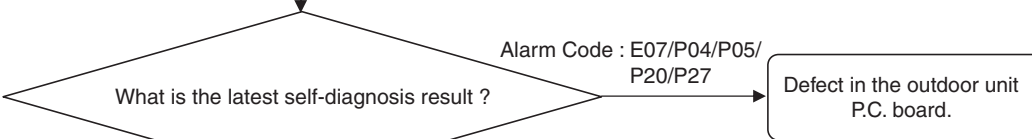

Fig. 3

1. Turn ON the power and operate the system using the remote controller or the operation button on the indoor unit.
 2. Perform the self-diagnosis five seconds after the operation start.



Alarm Code : E05

1. Turn off the power and wait until the power lamp (LED) of the outdoor unit controller is turned OFF.
 2. Remove the short-circuit between the terminals 2 and 3 on the outdoor unit terminal strip.
 3. Disconnect the cable from the terminal 3 on the indoor unit terminal strip. (Fig. 4)

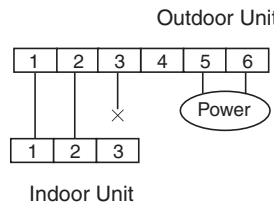

Fig. 4

Short-circuit between the terminals 2 and 3 on the indoor unit terminal board. (Fig. 5)

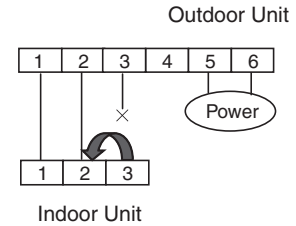
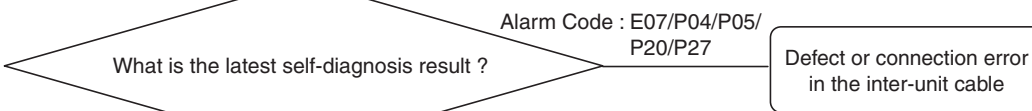

Fig. 5

1. Turn ON the power and operate the system using the remote controller or the operation button on the indoor unit.
 2. Perform the self-diagnosis five seconds after the operation start.



Alarm Code : E05

Defect in the indoor unit P.C. board

(3-2) Alarm Code : E07/P04/P05/P20/P27

Troubleshooting Serial Communication

1. Turn off the power and wait until the power lamp (LED) of the outdoor unit controller is turned OFF.
2. Disconnect the cable from the terminal 3 on the Outdoor unit terminal strip. (Fig. 6)

1. Turn ON the power and operate the system using the remote controller or the operation button on the indoor unit.
2. Perform the self-diagnosis five seconds after the operation start.

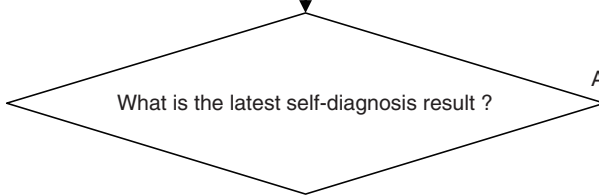

Alarm Code : E05

Defect in the outdoor unit P.C. board

Alarm Code : E07/P04/P05/P20/P27

1. Turn off the power and wait until the power lamp (LED) of the outdoor unit controller is turned OFF.
2. Disconnect the cable from the terminal 3 on the indoor unit terminal strip. (Fig. 7)

1. Turn ON the power and operate the system using the remote controller or the operation button on the indoor unit.
2. Perform the self-diagnosis five seconds after the operation start.

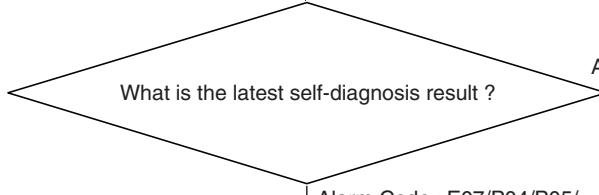

Alarm Code : E05

Defect in the inter-unit cable

Alarm Code : E07/P04/P05/P20/P27

Defect in the indoor unit P.C. board

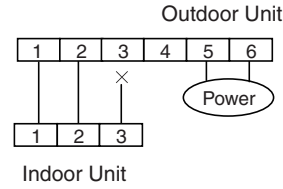

Fig. 6

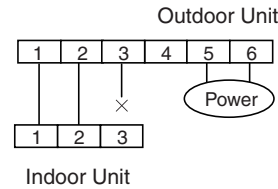

Fig. 7

8-4. Trouble Diagnosis of Fan Motor

8-4-1. Indoor Fan Motor

- This indoor DC fan motor contains an internal control PCB. Therefore, it is not possible to measure the coil resistance, and the following procedure should be used to check the motor.
- To perform diagnosis, operate the unit in cooling mode with indoor fan speed "High". Next, make sure that the indoor unit receive the signals from the remote controller when the ON/OFF operation button is pressed.

Important: (A) Turn OFF the power before connecting or disconnecting the motor connectors.
(B) When performing voltage measurement at the indoor controller connector for (3) in the table below, the DC motor will trip and voltage output will stop approximately 1 minute after operation is started. For this reason, to measure the voltage again, turn OFF the unit once using the remote controller, and then start the air conditioner again.

[Trouble symptom 1] The fan does not stop when the unit stops. →Indoor unit controller trouble.

[Trouble symptom 2] The fan motor does not rotate when the unit is operating.

(Diagnostic procedure)

* Disconnect the motor connectors and measure the voltage at the DC motor connectors on the indoor unit controller (3 locations).

Measurement location	Normal value
(1) Vm-Gnd: Between pin 1 and pin 4	DC 280 V +/-10%
(2) Vcc-Gnd: Between pin 5 and pin 4	DC 15 V +/-10%
(3) Vs-Gnd: Between pin 6 and pin 4	Fluctuation between DC 1.63 to 6.23 V

(Diagnostic results)

All of the above measured values are normal. →Fan motor trouble (Replace the motor.)

Any one of the above measured values is not normal. →Indoor unit controller trouble (Replace the controller .)

(Reference) DC motor connector pin arrangement

Pin 1: Vm (red)
Pin 2: Not used
Pin 3: Not used
Pin 4: Gnd (black)
Pin 5: Vcc (white)
Pin 6: Vs (yellow)
Pin 7: PG (blue)

[Trouble symptom 3] Motor rotates for some time (several seconds), but then quickly stops, when the indoor unit operates.

(There is trouble in the system that provides feedback of motor rotation speed from the motor to the indoor unit controller.)

[Trouble symptom 4] Fan motor rotation speed does not change during indoor unit operation.

[Trouble symptom 5] Fan motor rotation speed varies excessively during indoor unit operation.

(Remedy for symptom 3 to 5)

It is not possible to identify whether the trouble is indoor unit controller trouble or motor trouble. Therefore, first replace the indoor unit controller, then (if necessary) replace the DC motor.

8-4-2. Outdoor Fan Motor

- This outdoor DC fan motor contains an internal control PCB. Therefore, it is not possible to measure the coil resistance, and the following procedure should be used to check the motor.
- Perform the trouble diagnosis by Test Run mode described on Installation Instructions of indoor unit.

Important: (A) Turn OFF the power before connecting or disconnecting the motor connectors.

(B) When performing voltage measurement at the outdoor controller connector for (3) in the table below, the DC motor will trip and voltage output will stop approximately 10 seconds after operation is started. For this reason, to measure the voltage again, first turn OFF the outdoor unit power, then, measure the voltage in Test Run mode.

[Trouble symptom 1] The fan does not stop when the outdoor unit stops. →Outdoor unit controller trouble

[Trouble symptom 2] The fan motor does not rotate when the outdoor unit is operating.

(Diagnostic procedure)

* Disconnect the motor connectors and measure the voltage at the DC motor connectors on the outdoor unit controller (3 locations).

Measurement location	Normal value
(1) Vm-Gnd : Between pin 1 and pin 3 of FM1	DC 280V +/- 10%
(2) Vcc-Gnd : Between pin 1 of FM2 and pin3 of FM1	DC 15V +/- 10%
(3) Vs-Gnd : Between pin 3 of FM2 and pin3 of FM1	Fluctuation between DC 1.8V to 5.7V

(Diagnostic results)

All of the above measured values are normal. → Fan motor trouble (Replace the motor.)

Any one of the above measured values is not normal. → Outdoor unit controller trouble
(Replace the controller .)

(Reference) DC motor connector pin arrangement

Connector No.	Pin
FM1	Pin 1: Vm (red)
	Pin 2: Not used
	Pin 3: Gnd (blue)
FM2	Pin 1: Vcc (brown)
	Pin 2: PG (white)
	Pin 3: Vsp (orange)

[Trouble symptom 3] Motor rotates for some time (several seconds), but then quickly stops, when the outdoor unit operates.

(There is trouble in the system that provides feedback of motor rotation speed from the motor to the outdoor unit controller.)

[Trouble symptom 4] Fan motor rotation speed does not change during outdoor unit operation.

[Trouble symptom 5] Fan motor rotation speed varies excessively during outdoor unit operation.

(Remedy for symptom 3 to 5)

It is not possible to identify whether the trouble is outdoor unit controller trouble or motor trouble. Therefore, first replace the outdoor unit controller, then (if necessary) replace the DC motor.

8-5. Noise Malfunction and Electromagnetic Interference

An inverter A/C operates using pulse signal control and high frequencies. Therefore, it is susceptible to the effects of external noise, and is likely to cause electromagnetic interference with nearby wireless devices.

A noise filter is installed for ordinary use, preventing these problems. However, depending on the installation conditions, these effects may still occur. Please pay attention to the points listed below.

(1) Noise malfunction

This refers to the application of high-frequency noise to the signal wires, resulting in abnormal signal pulses and malfunction.

Locations most susceptible to noise	Trouble	Correction
<ol style="list-style-type: none"> Locations near broadcast stations where there are strong electromagnetic waves Locations near amateur radio (short wave) stations Locations near electronic sewing machines and arc-welding machines 	<p>Either of the following trouble may occur.</p> <ol style="list-style-type: none"> The unit may stop suddenly during operation. Indicator lamps may flicker. 	<p>(The fundamental concept is to make the system less susceptible to noise.)</p> <p>- Insulate for noise or distance from the noise source. -</p> <ol style="list-style-type: none"> Use shielded wires. Move unit away from the noise source.

(2) Electromagnetic interference

This refers to noise generated by high-speed switching of the microcomputer and compressor. This noise radiates through space and returns to the electric wiring, affecting any wireless devices (televisions, radios, etc.) located nearby.

Locations most susceptible to noise	Trouble	Correction
<ol style="list-style-type: none"> A television or radio is located near the A/C and A/C wiring. The antenna cable for a television or radio is located close to the A/C and A/C wiring. Locations where television and radio signals are weak. 	<ol style="list-style-type: none"> Noise appears in the television picture, or the picture is distorted. Static occurs in the radio sound. 	<ol style="list-style-type: none"> Select a separate power source. Keep the A/C and A/C wiring at least 1 meter away from wireless devices and antenna cables. Change the wireless device's antenna to a high-sensitivity antenna. Change the antenna cable to a BS coaxial cable. Use a noise filter (for the wireless device). Use a signal booster.

9. CHECKING ELECTRICAL COMPONENTS

9-1. Measurement of Insulation Resistance

- The insulation is in good condition if the resistance exceeds 1M ohm.

9-1-1. Power Supply Cord

Clamp the grounding wire of power cord with the lead clip of the insulation resistance tester and measure the resistance by placing a probe on either of the two power wires. (Fig. 1)

Then also measure the resistance between the grounding and other power terminals. (Fig. 1)

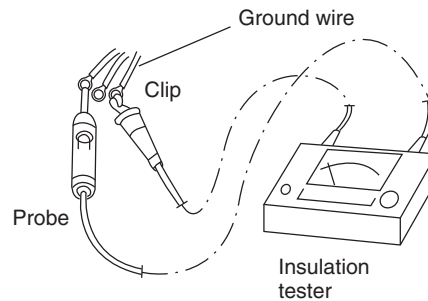

Fig. 1

9-1-2. Indoor Unit

Clamp an aluminum plate fin or copper tube with the lead clip of the insulation resistance tester and measure the resistance by placing a probe on each terminal screw on the terminal plate. (Fig. 2)

Note that the ground line terminal should be skipped for the check.

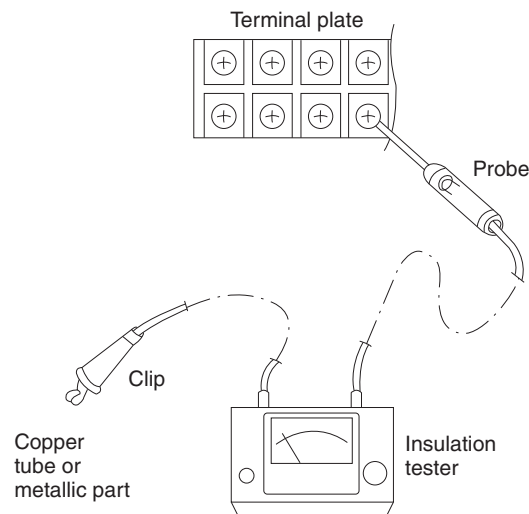

Fig. 2

9-1-3. Outdoor Unit

Clamp a metallic part of the unit with the lead clip of the insulation resistance tester and measure the resistance by placing a probe on each terminal screw where power supply lines are connected on the terminal plate. (Fig. 2)

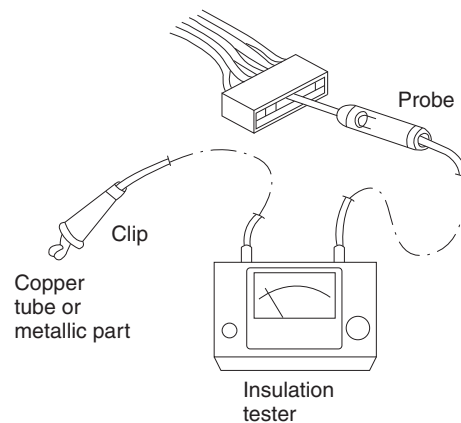

Fig. 3

9-1-4. Measurement of Insulation Resistance for Electrical Parts

Disconnect the lead wires of the desired electric part from terminal plate, capacitor, etc. Similarly disconnect the connector. Then measure the insulation resistance. (Figs. 3 and 4)

NOTE

Refer to Electric Wiring Diagram.

If the probe cannot enter the poles because the hole is too narrow then use a probe with a thinner pin.

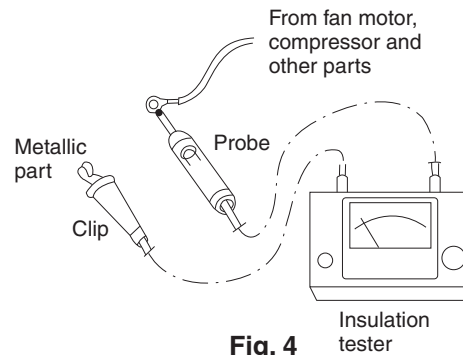

Fig. 4

9-2. Checking Continuity of Fuse on PCB Ass'y

- Remove the PCB Ass'y from the electrical component box. Then pull out the fuse from the PCB Ass'y. (Fig. 5)
- Check for continuity using a multimeter as shown in Fig. 6.

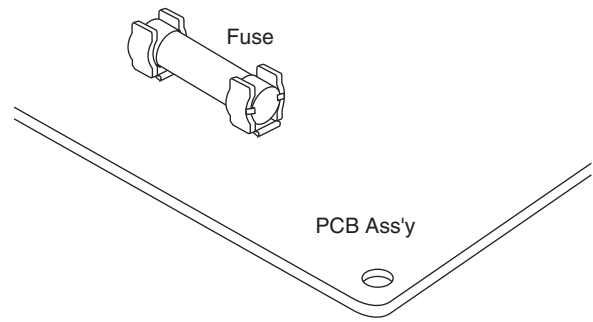

Fig. 5

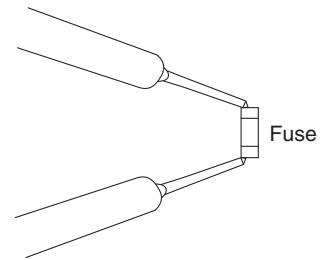

Fig. 6

10. REFRIGERANT R410A: SPECIAL PRECAUTIONS WHEN SERVICING UNIT

10-1. Characteristics of New Refrigerant R410A

10-1-1. What is New Refrigerant R410A?

R410A is a new refrigerant that contains two types of pseudo-non-azeotropic refrigerant mixture. Its refrigeration capacity and energy efficiency are about the same level as the conventional refrigerant, R22.

10-1-2. Components (mixing proportions)

HFC32 (50%) / HFC125 (50%)

10-1-3. Characteristics

- Less toxic, more chemically stable refrigerant
- The composition of refrigerant R410A changes whether it is in a gaseous phase or liquid phase. Thus, when there is a refrigerant leak the basic performance of the air conditioner may be degraded because of a change in composition of the remaining refrigerant. **Therefore, do not add new refrigerant.** Instead, recover the remaining refrigerant with the refrigerant recovery unit. Then, after evacuation, totally recharge the specified amount of refrigerant with the new refrigerant at its normal mixed composition state (in liquid phase).
- When refrigerant R410A is used, the composition will differ depending on whether it is in gaseous or liquid phase, and the basic performance of the air conditioner will be degraded if it is charged while the refrigerant is in gaseous state. **Thus, always charge the refrigerant while it is in liquid phase.**



CAUTION

Ether-type oil is used for compressor oil for R410A-type units, which is different from the mineral oil used for R22. Thus more attention to moisture prevention and faster replacement work compared with conventional models are required.

10-2. Checklist before Servicing

Use a clutch-type flare tool for R410A or the conventional flare tool. Note that sizes of the resultant flares differ between these two tools. Where a conventional flare tool is used, make sure to observe A Specification (amount of extrusion) by using the flare spacer.

Diameter of tube D	Specification A	
	Flare tool for R410A	Conventional flare tool (for R22)
Dia. 1/4" (6.35 mm)	0 to 0.0196" (0 to 0.5 mm)	0.0472" (1.2 mm)
Dia. 3/8" (9.52 mm)		
Dia. 1/2" (12.7 mm)		
Dia. 5/8" (15.88 mm)		

● Size of flare

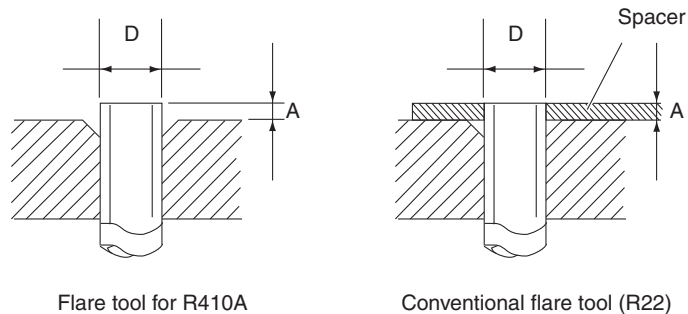

● Tubing precautions

- Refrigerant R410A is more easily affected by dust or moisture compared with R22, thus be sure to temporarily cover the ends of the tubing with caps or tape prior to installation.

Never use 0.0276" (0.7 mm)-thick copper tubing or tubing which is less than 0.0315" (0.8 mm) in thickness, since air conditioners with R410A are subject to higher pressure than those using R22 and R407C.

● No addition of compressor oil for R410A

No additional charge of compressor oil is permitted.

● No use of refrigerant other than R410A

Never use a refrigerant other than R410A.

● If refrigerant R410A is exposed to fire

Through welding, etc., toxic gas may be released when R410A refrigerant is exposed to fire. Therefore, be sure to provide ample ventilation during installation work.

● Caution in case of R410A leak

Check for possible leak points with the special leak detector for R410A. If a leak occurs inside the room, immediately provide thorough ventilation.

10-3. Tools Specifically for R410A

- For servicing, use the following tools for R410A

Tool Distinction	Tool Name
Tools specifically for R410A	<ul style="list-style-type: none"> ● Gauge manifold ● Charging hose ● Gas leak detector ● Refrigerant cylinder ● Charging cylinder ● Refrigerant recovery unit ● Vacuum pump with anti-reverse flow (*1) (Solenoid valve-installed type, which prevents oil from flowing back into the unit when the power is off, is recommended.) ● Vacuum pump (*2)...can be used if the following adapter is attached. ● Vacuum pump adapter (reverse-flow prevention adapter) (*3). (Solenoid valve-installed adapter attached to a conventional vacuum pump.) ● Electronic scale for charging refrigerant ● Flare tool
Tools which can be commonly used for R22, R407C, and R410A	<ul style="list-style-type: none"> ● Bender ● Torque wrench ● Cutter, reamer ● Welding tool, nitrogen gas cylinder



CAUTION

- **The above tools specifically for R410A must not be used for R22 and R407C. Doing so will cause malfunction of the unit.**
- **For the above vacuum pump (*1, *2) and vacuum pump adapter (*3), those for R22-type units can be used for R410A-type. However, they must be used exclusively for R410A and never alternately with R22 and R407C.**
- To prevent other refrigerants (R22, R407C) from being mistakenly charged to this unit, shape and external diameter of the service port screw has been altered.
 <External diameter of service port> R410A : 5/16"
 R22, R407C : 1/4"

10-4. Tubing Installation Procedures

When the tubes are connected, **always apply HAB oil on the flare portions to improve the sealing of tubing.**

The following is the **HAB oil** generally used:

Esso: ZERICE S32

NOTE For details on tubing installation procedures, refer to the installation manuals attached to the indoor unit and outdoor unit.

10-5. In Case of Compressor Malfunction



CAUTION

- Should the compressor malfunction, be sure to make the switch to a replacement compressor as quickly as possible.
- Use only the tools indicated exclusively for R410A. → See "10-3. Tools Specifically for R410A."

10-5-1. Procedure for Replacing Compressor

(1) Recovering refrigerant

- Any remaining refrigerant inside the unit should not be released to the atmosphere, but recovered using the refrigerant recovery unit for R410A.
- Do not reuse the recovered refrigerant, since it will contain impurities.

(2) Replacing Compressor

- Soon after removing seals of both discharge and suction tubes of the new compressor, replace it quickly.

(3) Checking for sealing

- Use nitrogen gas for the pressurized gas, and never use a refrigerant other than R410A. Also do not use oxygen or any flammable gas.

(4) Evacuation

- **Use a solenoid valve-installed vacuum pump** so that even if power is cut off in the middle of evacuation of air due to a power interruption, the valve will prevent the pump oil from flowing back.
- The equipment may be damaged if moisture remains in the tubing, thus carry out the evacuation thoroughly.
- When using a vacuum pump with exhaust air volume more than 0.883 cu.ft./min. and ultimate vacuum pressure rate of 50 micron Hg.

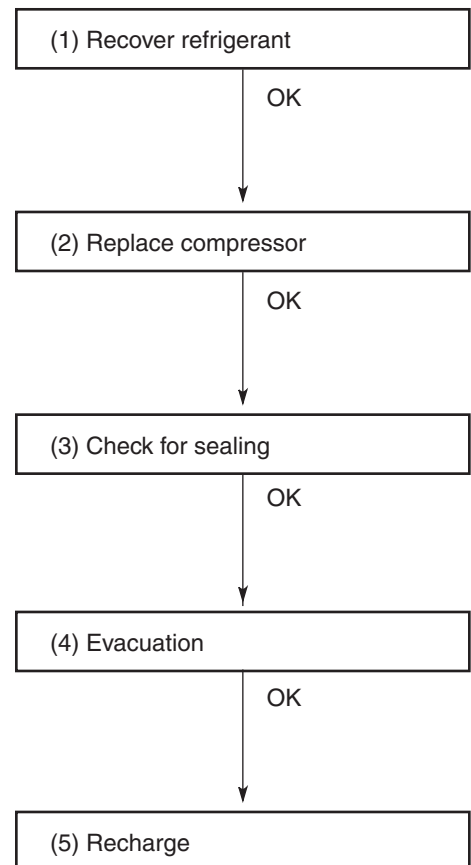

Standard time for evacuation

Length of tubing	Less than 33 ft. (10 m)	More than 33 ft. (10 m)
Evacuation time	More than 10 minutes	More than 15 minutes

(5) Recharging

- **Be sure to charge the specified amount of refrigerant in liquid state** using the service port of the wide tube service valve. The proper amount is listed on the unit's nameplate.

When the entire amount cannot be charged all at once, charge gradually while operating the unit in Cooling Operation.



CAUTION

Never charge a large amount of liquid refrigerant at once to the unit. This may cause damage to the compressor.

- When charging with a refrigerant cylinder, use an electronic scale for charging refrigerant. In this case, if the volume of refrigerant in the cylinder becomes less than 20% of the fully-charged amount, the composition of the refrigerant starts to change. Thus, **do not use the refrigerant if the amount in the charging cylinder is less than 20%.**

Also, charge the minimum necessary amount to the charging cylinder before using it to charge the air conditioning unit.

Example:

In case of charging refrigerant to a unit requiring 1.68 lb. (0.76 Kg) using a capacity of a 22 lb. (10 Kg) cylinder, the minimum necessary amount for the cylinder is:

$$1.68 + 22 \times 0.20 = 6.08 \text{ lb.}$$

$$(0.76 + 10 \times 0.20 = 2.76 \text{ Kg})$$

- **For the remaining refrigerant, refer to the instructions of the refrigerant manufacturer.**

If using a charging cylinder, transfer the specified amount of liquid refrigerant from the refrigerant cylinder to the charging cylinder.

Prepare an evacuated charging cylinder beforehand.



CAUTION

- **To prevent the composition of R410A from changing, never bleed the refrigerant gas into the atmosphere while transferring the refrigerant. (Fig. 3)**

Do not use the refrigerant if the amount in the charging cylinder is less than 20%.

Configuration and characteristics of cylinders

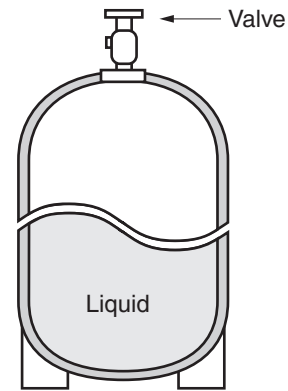

Single valve

Charge liquid refrigerant with cylinder in up-side-down position.

Fig. 1

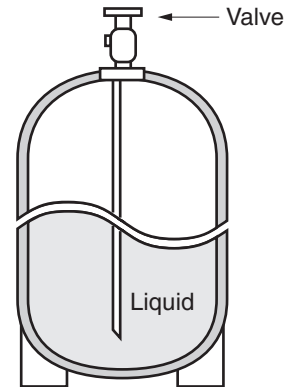

Single valve (with siphon tube)

Charge with cylinder in normal position.

Fig. 2

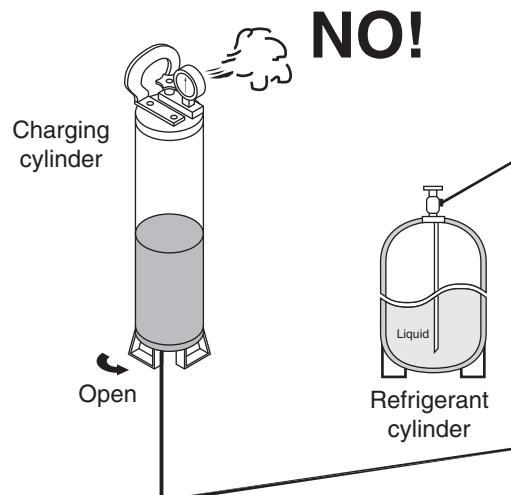

Fig. 3

10-6. In Case Refrigerant is Leaking



CAUTION

Never attempt to charge additional refrigerant when refrigerant has been leaking from the unit. Follow the procedure described below to locate points of leaks and carry out repairs, then recharge the refrigerant.

(1) Detecting Leaks

- Use the detector for R410A to locate refrigerant leak points.

(2) Recovering refrigerant

- Never release the gas to the atmosphere; recover residual refrigerant using the refrigerant recovery unit for R410A, instead.
- Do not reuse the recovered refrigerant because its composition will have been altered.

(3) Welding leaking points

- Confirm again that no residual refrigerant exists in the unit before starting welding.
- Weld securely using flux and wax for R410A.
- Prevent oxide film from forming inside the tubes utilizing substitution with nitrogen (N₂) in the refrigerant circuit of the unit. Leave ends of tubes open during welding.

(4) Checking for sealing

- Use nitrogen gas for the pressurized gas, and never use a refrigerant other than R410A. Also do not use oxygen or any flammable gas.

(5) Evacuation

- **Use a solenoid valve-installed vacuum pump** so that even if power is cut off in the middle of evacuation of air due to a power interruption, the valve will prevent the pump oil from flowing back.
- The equipment may be damaged if moisture remains in the tubing, thus carry out the evacuation thoroughly.
- When using a vacuum pump with exhaust air volume more than 0.883 cu.ft./min. and ultimate vacuum pressure rate of 50 micron Hg.

Standard time for evacuation

Length of tubing	Less than 33 ft. (10 m)	More than 33 ft. (10 m)
Evacuation time	More than 10 minutes	More than 15 minutes

(6) Recharging

- Recharge unit in the same manner explained on the previous page "(5) Recharging."

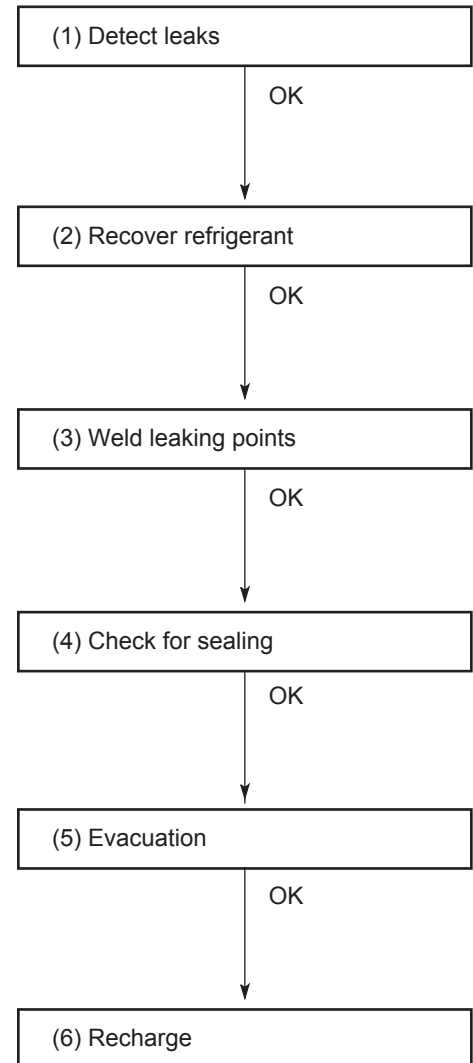

10-7. Charging Additional Refrigerant

10-7-1. When Tubes are Extended

- Observe the proper amount of refrigerant as stated in this service manual or the installation manual that came with the indoor unit. **Charge additional refrigerant in liquid state only.**



CAUTION

Never charge additional refrigerant if refrigerant is leaking from the unit. Follow instructions given in "10-6. In Case Refrigerant is Leaking" and completely carry out repairs. Only then should you recharge the refrigerant.

10-8. Retro-Fitting Existing Systems

10-8-1. Use of Existing Units

- **Never use new refrigerant R410A for existing units which use R22.** This will cause the air conditioner to operate improperly and may result in a hazardous condition.

10-8-2. Use of Existing Tubing

- If replacing an older unit that used refrigerant R22 with a R410A unit, **do not use its existing tubing.** Instead, completely new tubing must be used.

APPENDIX A Operating Instructions

CS-KE30NKU + CU-KE30NKU
CS-KE36NKU + CU-KE36NKU

(852-6-4181-221-00-2)

Panasonic[®]

Operating Instructions Split System Air Conditioner



Model No.

Indoor Units

CS-KE30NKU

CS-KE36NKU

Outdoor Units

CU-KE30NKU

CU-KE36NKU

This air conditioner uses the refrigerant R410A.



Before operating the unit, read these operating instructions thoroughly and keep them for future reference.

Panasonic Corporation
1006 Kadoma, Kadoma City, Osaka, Japan

FEATURES

This air conditioner is an inverter type unit that automatically adjusts capability as appropriate. Details on these functions are provided below; refer to these descriptions when using the air conditioner.

- **Microprocessor Controlled Operation**
The interior compartment of the remote controller contains several features to facilitate automatic operation, easy logically displayed for easy use.
- **Simple One-touch Remote Controller**
The remote controller has several features to facilitate automatic operation.
- **24-Hour ON or OFF Timer**
This timer can be set to automatically turn the unit on or off at any time within a 24 hour period.
- **1-Hour OFF Timer**
This timer can be set to automatically turn off the unit at any time after one hour.
- **Night Setback**
This function saves energy by controlling operation to provide a quieter operating sound than normal.
- **Automatic and 3-step Fan Speed**
Auto/High/Medium/Low
- **Air Sweep Control**
This function moves a flap up and down in the air outlet, directing air in a sweeping motion around the room and providing comfort in every corner.
- **Auto. Flap Control**
This automatically sets the flap to the optimum position during heating, cooling, and drying operation.
- **Automatic Switching between Cooling and Heating**
This unit automatically switches between cooling operation and heating operation according to the difference between the room temperature and the temperature setting.
- **Hot Start Heating System**
Right from the start, the air is warm and comfortable. This system prevents any cold blasts at the beginning while the heat pump is warming up, or even defrosting.
- **Automatic Restart Function for Power Failure**
Even when power failure occurs, preset programmed operation can be reactivated once power resumes.
- **High Power Operation**
If not in Auto Operation, the unit operates at maximum output for 30 minutes, regardless of the desired temperature.
The fan speed is 1 step above "High".
- **Quiet Operation**
The fan rotates slower than the fan speed setting to provide a quieter operating sound.
- **Unoccupied**
This function prevents the room temperature from decreasing too much (or increasing too much) when no one is in the room, and operate automatically to save energy.

CONTENTS

	Page		Page
FEATURES.....	2	SPECIAL REMARKS	12
PRODUCT INFORMATION	2	SETTING THE TIMER	13
SAFETY PRECAUTIONS.....	2	USING THE 1-HOUR OFF TIMER	14
INSTALLATION LOCATION.....	3	TIPS FOR ENERGY SAVING	14
ELECTRICAL REQUIREMENTS	3	ADJUSTING THE AIRFLOW DIRECTION	15
SAFETY INSTRUCTIONS.....	3	OPERATION WITHOUT THE REMOTE CONTROLLER.....	15
NAMES OF PARTS	4	CARE AND CLEANING	16
USING THE REMOTE CONTROLLER	8	TROUBLESHOOTING (BEFORE CALLING FOR SERVICE) ..	17
OPERATION WITH THE REMOTE CONTROLLER.....	9	OPERATING RANGE.....	17
1. Automatic Operation	9	WIRED REMOTE CONTROLLER	17
2. Manual Operation.....	9	SPECIFICATIONS.....	18
3. Adjusting the Fan Speed	10		
4. Fan Only.....	10		
5. Night Setback Mode.....	10		
6. QUIET Mode	10		
7. HIGH POWER Mode.....	11		
8. UNOCCUPIED Mode	11		

PRODUCT INFORMATION

If you have problems or questions concerning your Air Conditioner, you will need the following information. Model and serial numbers are on the nameplate on the bottom of the cabinet.

Model No. _____

Serial No. _____

Date of purchase _____

Dealer's address _____

Phone number _____

SAFETY PRECAUTIONS

The following symbols used in this manual, alert you to potentially dangerous conditions to users, service personnel or the appliance:



WARNING

This symbol refers to a hazard or unsafe practice which can result in severe personal injury or death.



CAUTION

This symbol refers to a hazard or unsafe practice which can result in personal injury or product or property damage.

INSTALLATION LOCATION

- We recommend that this air conditioner be installed properly by qualified installation technicians in accordance with the Installation Instructions provided with the unit.
- Before installation, check that the voltage of the electric supply in your home or office is the same as the voltage shown on the nameplate.



WARNING

- Do not install this air conditioner where there are fumes or flammable gases, or in an extremely humid space such as a greenhouse.
- Do not install the air conditioner where excessively high heat-generating objects are placed.

Avoid:

To protect the air conditioner from heavy corrosion, avoid installing the outdoor unit where salty sea water can splash directly onto it or in sulphurous air near a spa.

ELECTRICAL REQUIREMENTS

1. All wiring must conform to the local electrical codes. Consult your dealer or a qualified electrician for details.
2. Each unit must be properly grounded with a ground (or earth) wire or through the supply wiring.
3. Wiring must be done by a qualified electrician.

NOTE

Pull off the power plug from a receptacle, or switch off the breaker, or switch off the power disconnecting mean to isolate the air conditioner from the main power supply when not in use for a long time.



SAFETY INSTRUCTIONS

- Read this Instruction Manual carefully before using this air conditioner. If you still have any difficulties or problems, consult your dealer for help.
- This air conditioner is designed to give you comfortable room conditions. Use this only for its intended purpose as described in this Instruction Manual.







WARNING

- Confirm to authorized dealer or specialist on usage of specified refrigerant type. Using of refrigerant other than the specified type may cause product damage, burst and injury etc.
- Never touch the unit with wet hands.
- Never use or store gasoline or other flammable vapor or liquid near the air conditioner — it is very dangerous.
- Do not use this appliance in a potentially explosive atmosphere.
- This air conditioner has no ventilator for intaking fresh air from outdoors. You must open doors or windows frequently when you use gas or oil heating appliances in the same room, which consume a lot of oxygen from the air. Otherwise there is a risk of suffocation in an extreme case.
- Do not swallow the battery.
- After removing the battery from remote controller, keep it away from the reach of children. The battery can cause death by suffocation if swallowed.
- When inserting the battery, make sure the polarities (+ and -) are correct.

- To prevent possible hazards from insulation failure, the unit must be grounded. 
- Do not clean inside the indoor and outdoor units by users. Engage authorized dealer or specialist for cleaning.
- In case of malfunction of this appliance, do not repair by yourself. Contact to the sales dealer or service dealer for a repair.
- Refrigerant gas leakage may cause fire.
- For safety, be sure to turn the air conditioner off and also to disconnect the power before cleaning. 
- Pull off the power plug from a receptacle, or switch off the breaker, or switch off the power disconnecting mean to isolate the air conditioner from the main power supply in case of emergency.



CAUTION

- Do not turn the air conditioner on and off from the power mains switch. Use the ON/OFF operation button.
- Do not stick anything into the air outlet of the outdoor unit. This is dangerous because the fan is rotating at high speed. 
- Do not touch the air inlet or the sharp aluminum fins of the outdoor unit. You may get injured. 
- Keep the fire alarm and the air outlet at least 1.5m away from the unit.
- Do not let children play with the air conditioner.
- Do not cool or heat the room too much if babies or invalids are present.
- Do not sit or step on the unit. You may fall down accidentally. 
- Do not stick any object into the FAN CASE. You may be injured and the unit may be damaged. 



NOTICE

- This device complies with part 15 of the FCC Rules. Operation is subject to the following two conditions: (1) This device may not cause harmful interference, and (2) this device must accept any interference received, including interference that may cause undesired operation.
- This equipment has been tested and found to comply with the limits for a Class B digital device, pursuant to part 15 of the FCC Rules. These limits are designed to provide reasonable protection against harmful interference in a residential installation. This equipment generates, uses and can radiate radio frequency energy and, if not installed and used in accordance with the instructions, may cause harmful interference to radio communications. However, there is no guarantee that interference will not occur in a particular installation. If this equipment does cause harmful interference to radio or television reception, which can be determined by turning the equipment off and on, the user is encouraged to try to correct the interference by one or more of the following measures:
 - Reorient or relocate the receiving antenna.
 - Increase the separation between the equipment and receiver.
 - Connect the equipment into an outlet on a circuit different from that to which the receiver is connected.
 - Consult the dealer or an experienced radio/TV technician for help.
- FCC Caution: To assure continued compliance, follow the attached installation instructions. Any changes or modifications not expressly approved by the party responsible for compliance could void the user's authority to operate this equipment.

NAMES OF PARTS

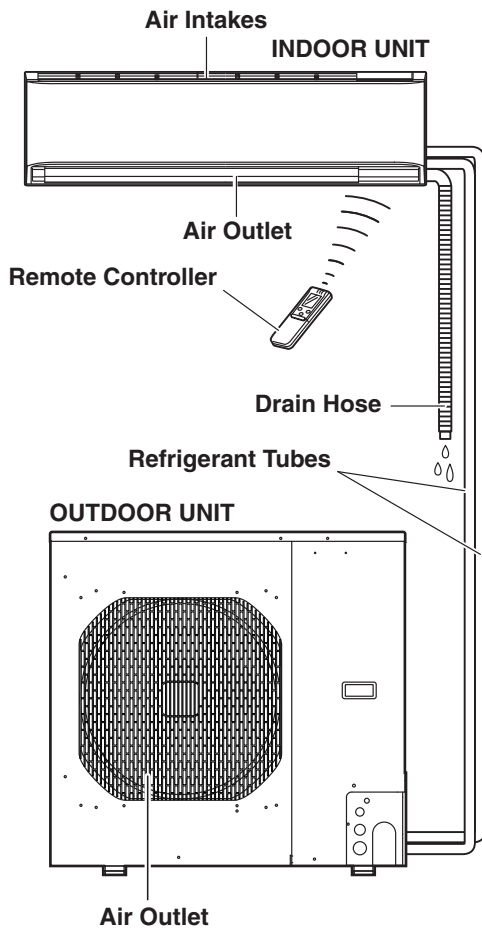

NOTE

This illustration is based on the external view of a standard model. Consequently, the shape may differ from that of the air conditioner which you have selected.

This air conditioner consists of an indoor unit and an outdoor unit. You can control the air conditioner with the remote controller.

Air Intake	Air from the room is drawn into this section and passes through air filters which remove dust.
Air Outlet	Conditioned air is blown out of the air conditioner through the air outlet.
Remote Controller	The remote controller controls power ON/OFF, operation mode selection, temperature, fan speed, timer setting, and air sweeping.
Refrigerant Tubes	The indoor and outdoor units are connected by copper tubes through which refrigerant gas flows.
Drain Hose	Moisture in the room condenses and drains off through this hose.
Outdoor (Condensing) Unit	The outdoor unit contains the compressor, fan motor, heat exchanger coil, and other electrical components.

UNIT DISPLAY AND OPERATION BUTTON

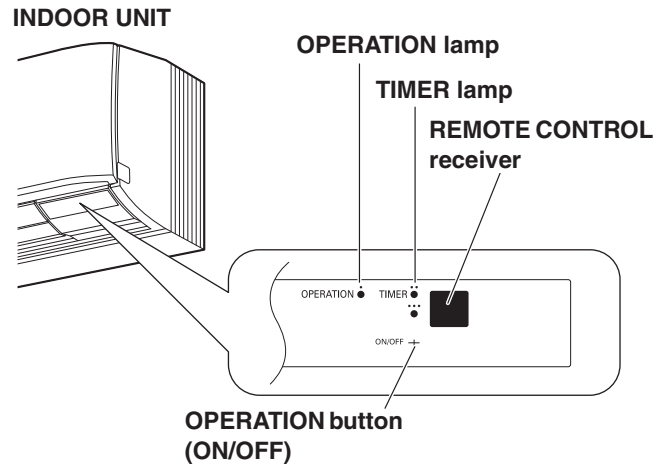

IMPORTANT

Avoid using radio equipment such as mobile phone near (within 4 ft. (1.2 m)) the remote control receiver. Some radio equipment may cause malfunction of the unit.

If the trouble happens, disconnect power and restart the air conditioner after a few minutes.

REMOTE CONTROL receiver	This section picks up infrared signals from the remote controller (transmitter).
OPERATION button	<p>When the remote controller cannot be used, pressing this button enables heating and cooling operation.</p> <p>Each time this button is pressed, the type of operation conducted is indicated by the changing color of the OPERATION lamp. Press the button and select the lamp color that suits your preference for operation.</p> <p style="text-align: center;"> Cooling operation (green) → Heating operation (red) → Stop (lamp off) </p> <p style="text-align: center;"> </p>
OPERATION lamp	This lamp lights when the system is in the continuous AUTO (red or green), HEAT (red), DRY (orange), COOL (green) and FAN (green) mode. The OPERATION lamp lights up red and orange alternately when the system is defrosting.
TIMER lamp	This lamp lights when the system is being controlled by the timer.

NOTE

The unit's display lamps are dimmed during operation in the NIGHT SETBACK mode.

REMOTE CONTROLLER (DISPLAY)

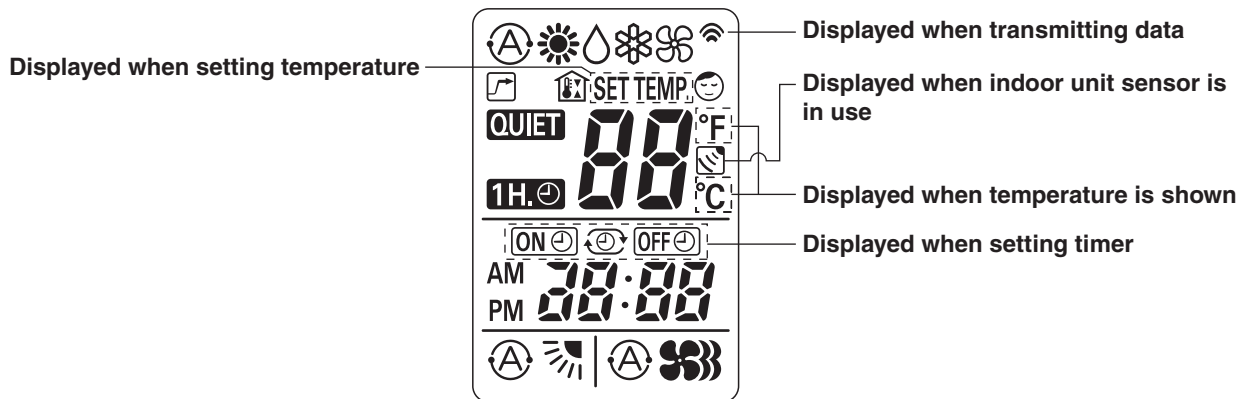

EG

Symbols

(1) Operation mode

- AUTO
- HEAT
- MILD DRY
- COOL
- FAN

(2) Fan speed

- Automatic operation
- HIGH
- MEDIUM
- LOW

(3) Temperature setting

- 60 – 86 °F
- When set to 80 °F temperature indication

(4) Timer

- 24-hour clock with ON/OFF program Timer
- ON Timer.
- OFF Timer.
- 1-hour OFF Timer.

(5) NIGHT SETBACK.....

(6) Confirmation of transmission

(7) Auto. flap indication.....

Flap angle indication.....

Sweep indication.....

(8) High power operation.....

(9) UNOCCUPIED

(10) Quiet operation

REMOTE CONTROLLER

Transmitter

When you press the buttons on the remote controller, the  mark appears in the display to transmit the setting changes to the receiver in the air conditioner.





Display

Information on the operating conditions is displayed while the remote controller is switched on. If the unit is turned off, FLAP setting and FAN SPEED setting are not displayed.

QUIET button



QUIET : When you press this button, the fan rotates slower than the fan speed setting to provide a quieter operating sound.

FAN SPEED selector button

-  : The air conditioner automatically decides the fan speeds.
-  : High fan speed
-  : Medium fan speed
-  : Low fan speed

FLAP button

Press this button either to select the setting of the airflow direction to the auto. flap in each mode or one of the six possible positions manually or to select the sweep function which moves the flap up and down automatically.

-  : Auto flap setting: If selected in a heating operation, the flap is set to position (3) in the following chart. If selected in a cooling or dry operation, the flap is set at position (7) in the following chart.
-  : The airflow direction can be set manually. (six positions)
-  : The flap moves up and down automatically.

NOTE

When you press the FLAP button, the air flow direction will be changed one by one as follows.

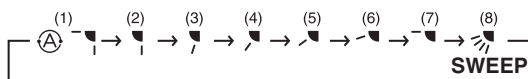





ON TIME/OFF TIME setting buttons

Advance button

Return button

No display: The timer does not operate.

-  : The air conditioner starts at the set time.
-  : The air conditioner stops at the set time.
-    : The air conditioner stops and starts, or starts and stops, at the set times every day. For details, see "SETTING THE TIMER".

CANCEL button

SENSOR button

When you press this button (use a small-tipped object such as a ballpoint pen), the  mark will appear at the display. And the room temperature is detected by the sensor which is built into the indoor unit and the air conditioner is controlled accordingly.

NOTE

If the remote controller is located near a heat source, such as a space heater or in direct sunlight, press the SENSOR button to switch to the sensor on the indoor unit.

ADDRESS switch

- The address switch changes to prevent mixing of signals from remote controller's when two air conditioners are installed next to each other. Normally, the address switch is set to A. For more information, please contact the dealer where you made the purchase.
- Normally, the tabs on the remote controller should not be bent.

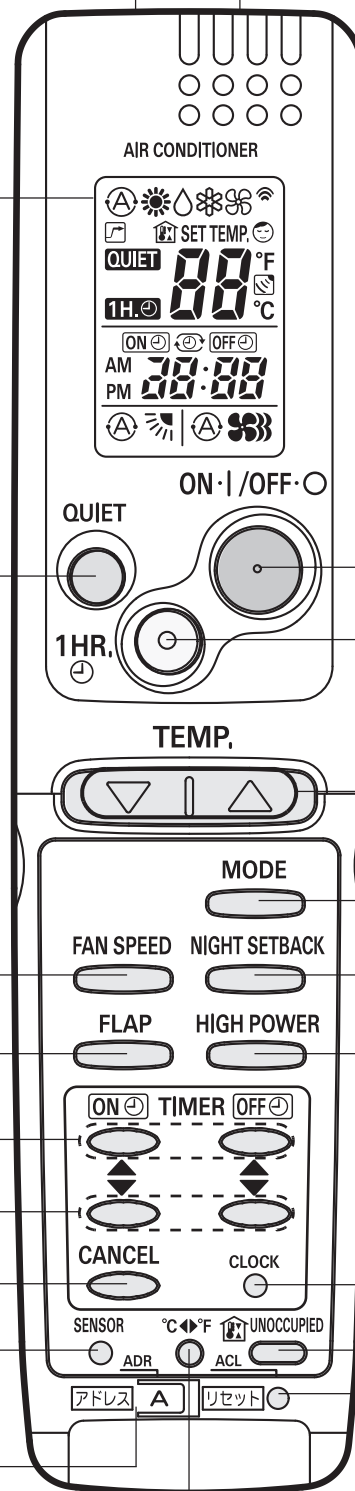

Temperature display selector button

This switches the temperature display between °C and °F.

Sensor

A temperature sensor inside the remote controller senses the room temperature.

ON/OFF operation button

This button is for turning the air conditioner on and off.

1 HR. TIMER button (1-HOUR OFF TIMER)

1H. ☺ : When you press this button, regardless of whether the unit is operating or stopping, the unit operates for one hour and then shuts down.

Temperature setting buttons (TEMP.)

Press the button to increase the set temperature.

Press the button to reduce the set temperature.

The temperature setting changes by 1 °C or 2 °F each time one of the TEMP. buttons is pressed.

MODE selector button

Use this button to select AUTO, HEAT, DRY, COOL or FAN mode.

(AUTO) Ⓐ : When this setting is selected, the air conditioner calculates the difference between the thermostat setting and the room temperature and automatically switches to the “COOL” or “HEAT” mode as appropriate.

(HEAT) ☀ : The air conditioner makes the room warmer.

(DRY) 💧 : The air conditioner reduces the humidity in the room.

(COOL) ❄ : The air conditioner makes the room cooler.

(FAN) 🌀 : The air conditioner works only as a circulation fan.

NIGHT SETBACK button

For details, see “5. Night Setback Mode”. When you press this button in the HEAT, DRY or COOL mode, the ☺ mark appears in the display, and the remote controller will automatically adjust the set temperature to save energy.

HIGH POWER button

: If this button is pressed during HEAT, DRY, COOL or FAN operation, the unit operates at maximum output for 30 minutes, regardless of the desired temperature. The fan speed is 1step above “HIGH”.

CLOCK button

UNOCCUPIED button

For details, see “8. UNOCCUPIED Mode”. When you press this button, the 🏠 mark appears in the display. And the remote controller will automatically prevent the room temperature from decreasing too much (or increasing too much) when no one is in the room.

ACL button (ALL CLEAR)

Puts the remote controller into pre-operation status. Always press this button after replacing the batteries.

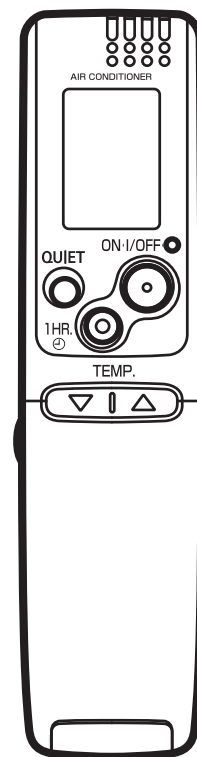

(Cover closed)

NOTE

- The illustration above pictures the remote controller after the cover has been opened.
- The remote controller sends the temperature signal to the air conditioner regularly at five minute intervals. If the signal from the remote controller stops for more than 15 minutes due to the loss of the remote controller or other trouble, the air conditioner will switch to the temperature sensor which is built into the indoor unit and control the room temperature. In these cases, the temperature around the remote controller may differ from the temperature detected at the air conditioner's position.
- The indoor fan runs continuously when the system is in normal operation. It does not turn off when the desired room temperature is reached. If Night Set Back mode is selected, the fan will turn off intermittently during cooling operation in order to control air flow.

USING THE REMOTE CONTROLLER

HOW TO INSTALL BATTERIES

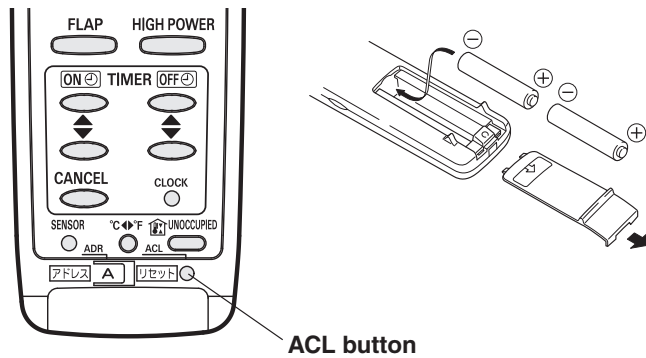

ACL button

1. Slide the cover in the direction indicated by the arrow and remove it.
2. Install two AAA alkaline batteries. Make sure the batteries point in the direction marked in the battery compartment.
3. Use a thin object such as the tip of a pen to press the ACL button.



CAUTION

- The batteries last about six months, depending on how much you use the remote controller. Replace the batteries when the remote controller's display fails to light, or when the remote controller cannot be used to change the air conditioner's settings.
- Use two fresh leak-proof type-AAA alkaline batteries.
- In replacing batteries, follow the instructions as mentioned in the sub-section "HOW TO INSTALL BATTERIES".
- If you do not use the remote controller more than 1 month, take out the batteries.
- Dispose of the used batteries at the designated location in compliance with the applicable local ordinances.

Information for Users on Collection and Disposal of Old Equipment and used Batteries



[Information on Disposal in other Countries outside the European Union]

These symbols are only valid in the European Union. If you wish to discard these items, please contact your local authorities or dealer and ask for the correct method of disposal.



Note for the battery symbol (bottom two symbol examples):

This symbol might be used in combination with a chemical symbol. In this case it complies with the requirement set by the Directive for the chemical involved.

Pb

HOW TO USE THE REMOTE CONTROLLER

When using the remote controller, always point the unit's transmitter head directly at the air conditioner's receiver.

Air Conditioner (Indoor unit)

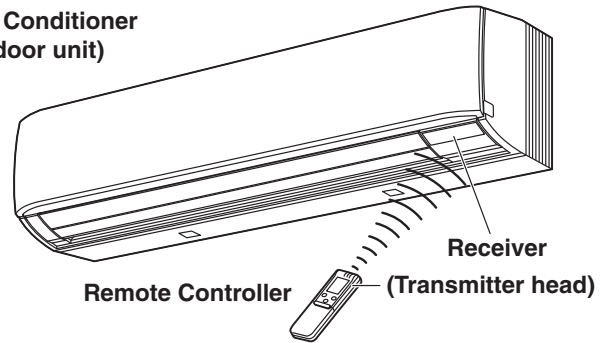

REMOTE CONTROLLER INSTALLATION POSITION

The remote controller may be operated either from a non-fixed position or from a wall-mounted position. To ensure that the air conditioner operates correctly, do not install the remote controller in the following places:

- In direct sunlight
- Behind a curtain or other places where it is covered
- More than 26 ft.(8 m) away from the air conditioner
- In the path of the air conditioner's airstream
- Where it may become extremely hot or cold
- Where it may be subject to electrical or magnetic noise
- Where there is an obstacle between the remote controller and air conditioner (since a check signal is sent from the remote controller every 5 minutes)

MOUNTING THE REMOTE CONTROLLER

Before mounting the remote controller, press the ON/OFF operation button at the mounting location to make sure that the air conditioner operates from that location. The indoor unit should make a beeping sound to indicate that it has received the signal.

Remote Control Holder

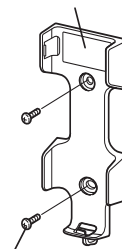

- 2 Press
- 1 Set in place

Rear Side

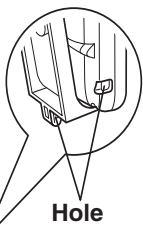

Mounting Screws
5/32 x 13/16"
(4 x 20 mm)
(included)

- To prevent loss of the remote controller, you can connect the remote controller to the holder by passing a string through the remote controller and attachment hole.

To take out the remote controller, pull it forward.

WHEN HOLDING THE REMOTE CONTROLLER

- When using the remote controller and during air conditioner operation, the transmitter on the remote controller should be pointed towards the receiver on the indoor unit.
- Make sure that there are no objects between the remote controller and receiver which could block the signal.

OPERATION WITH THE REMOTE CONTROLLER

1. Automatic Operation

This unit automatically switches between cooling operation and heating operation according to the difference between the room temperature and the temperature setting.

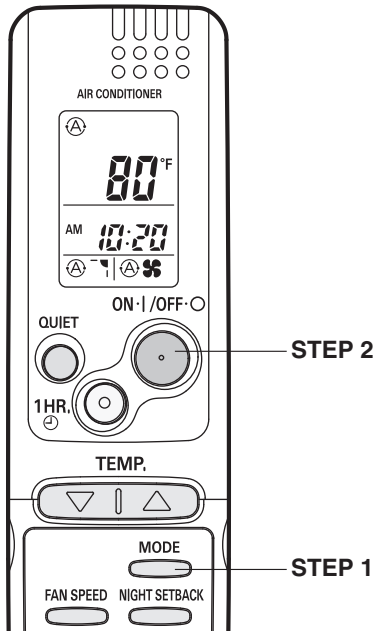

NOTE Check that the circuit breaker on the power panel is turned on.

Once (A) mode is selected and the unit is preset by following the steps below, you can have the air conditioner automatically bring the room to the desired temperature simply by pressing the ON/OFF operation button.

STEP 1	Press the MODE selector button to (A) .
STEP 2	Press the ON/OFF operation button.

To stop the air conditioner, press the ON/OFF operation button again.

NOTE • To change the temperature setting; press the temperature setting buttons and change the setting to the desired temperature.

2. Manual Operation

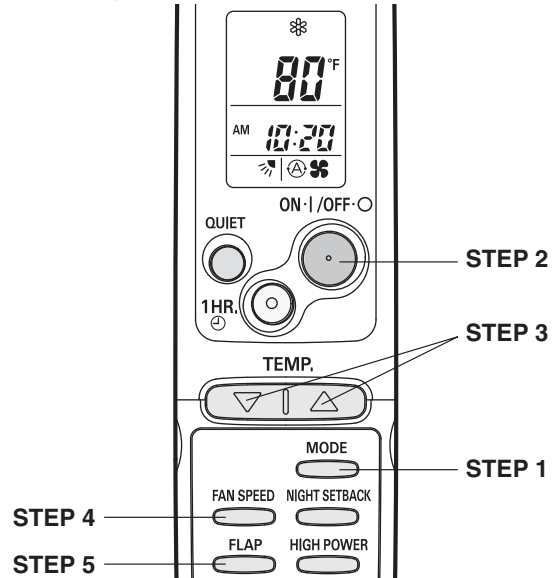

NOTE Check that the circuit breaker on the power panel is turned on.

If the automatic operation settings of the unit do not meet your needs, press the setting buttons as described below and change the settings as desired.

STEP 1	Press the MODE selector button and select the desired mode. For heating operation → ☀ For dehumidifying operation → 💧 For cooling operation → ❄️ For fan only operation → 🌀
STEP 2	To start the air conditioner, press the ON/OFF operation button.
STEP 3	Press the TEMP. setting buttons to change the temperature setting to the desired temperature. Adjustable temperature range: 30 °C max. or 86 °F max. 16 °C min. 60 °F min.
STEP 4	Set the FAN SPEED selector button to the setting you want.
STEP 5	Press the FLAP button and set the airflow direction as desired. (Refer to “ADJUSTING THE AIRFLOW DIRECTION” on page 15.)

To stop the air conditioner, press the ON/OFF operation button again.

NOTE • Choose the best position in the room for the remote controller, which also acts as the sensor for room comfort and transmits the operating instructions. Once you’ve found this best position, always keep the remote controller there.
• This appliance has a built-in 5-minute time delay circuit to ensure reliable operation. When the operation button is pressed, the compressor will start running within three minutes. In the event of power failure, the unit will stop.

3. Adjusting the Fan Speed

A. Automatic fan speed

Simply set the FAN SPEED selector button to the position.

This automatically sets the best fan speed for the room temperature.

B. Manual fan speed

If you want to adjust fan speed manually during operation, just set the FAN SPEED selector button as desired. [, , or]

4. Fan Only

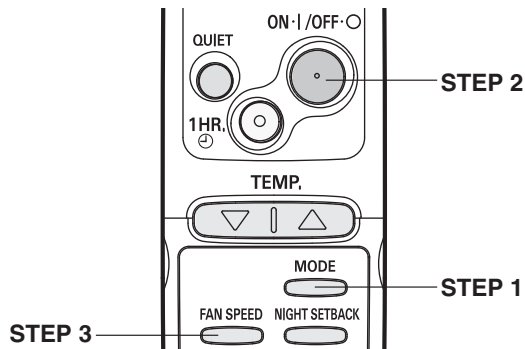

If you want to circulate air without any temperature control, follow these steps:

STEP 1	Press the MODE selector button to switch to the fan mode .
STEP 2	Press the ON/OFF operation button.
STEP 3	Press the FAN SPEED selector button to select the fan speed of your choice (, , or).

5. Night Setback Mode

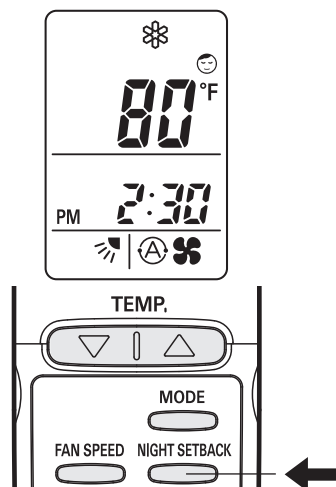

Night Setback Mode is used for saving energy.

Press the NIGHT SETBACK button while unit is operating. (except AUTO and FAN mode)
The mark appears in the display.

To release the night setback function, press the NIGHT SETBACK button again.

NOTE

Pressing the MODE selector button cancels Night Setback mode.

A. In Cooling and DRY Mode: (and)

When the night setback mode is selected, the air conditioner automatically raises the temperature setting 2 °F when 30 minutes have passed after the selection was made, and then another 2 °F after another 30 minutes have passed, regardless of the indoor temperature when night setback was selected. This enables you to save energy without sacrificing comfort. This function is convenient when gentle cooling is needed.

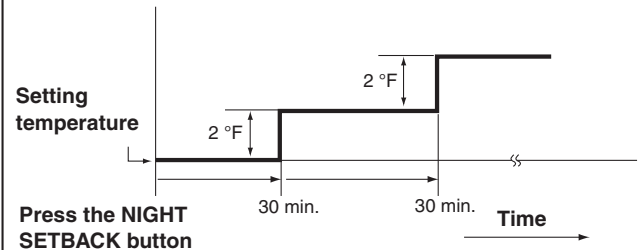

B. In Heating Mode: ()

When the night setback mode is selected, the air conditioner automatically lowers the temperature setting 4 °F when 30 minutes have passed after the selection was made, and then another 4 °F after another 30 minutes have passed, regardless of the indoor temperature when night setback was selected. This enables you to save energy without sacrificing comfort. This function is convenient when gentle heating is needed.

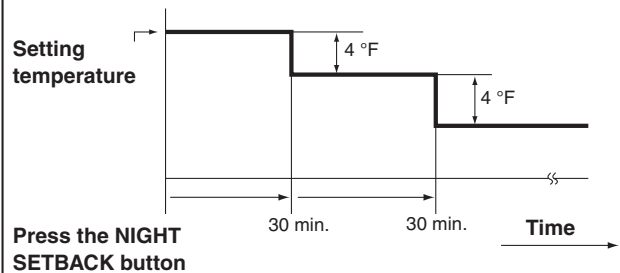

6. QUIET Mode

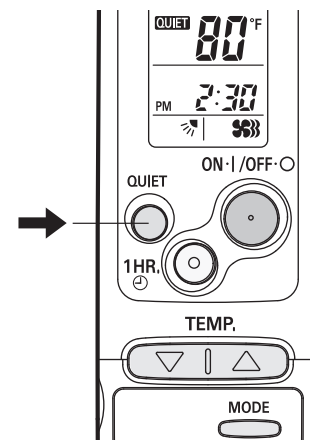

QUIET Mode is used to reduce the fan sound of the indoor unit.

Press the QUIET button.
The **QUIET** mark appears in the display.

To cancel, press QUIET button again.

- In QUIET Mode, the fan rotates at a slower speed than the fan speed setting.
- If the unit is already operating with a very low airflow, the fan sound may not change even if the QUIET button is pressed.

7. HIGH POWER Mode

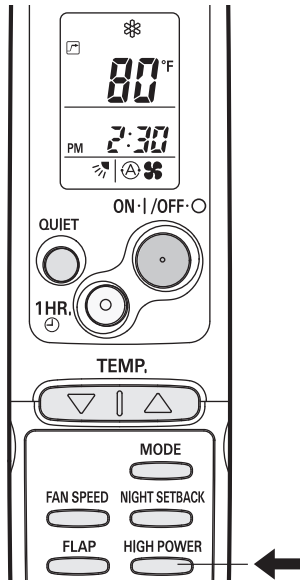

HIGH POWER mode can be used to increase the output of the indoor unit for all operation modes except automatic operation. Press the HIGH POWER button while unit is operating. The mark appears in the display.

To cancel, press HIGH POWER button again.

- When the HIGH POWER button is pressed, the unit operates at maximum output for 30 minutes, regardless of the desired temperature. The fan speed is 1 step above “High”.
- HIGH POWER Mode cannot be used when the operation mode is in Automatic Operation.
- QUIET Mode and HIGH POWER Mode cannot be used at the same time.

NOTE

- Pressing the MODE selector button cancels HIGH POWER mode.
- When set to High fan speed during heating operation, the fan runs at High fan speed even though the mark is displayed.
- Depending on the operating conditions, the fan speed may be increased by a small amount only.

8. UNOCCUPIED Mode

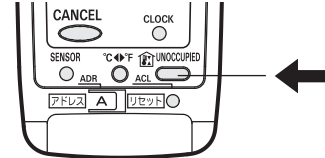
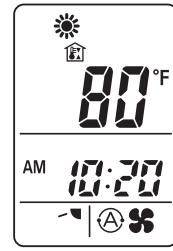

Unoccupied mode is used to prevent the room temperature from decreasing too much (or increasing too much) when no one is in the room, and operates automatically to save energy.

Press the UNOCCUPIED button.

The mark appears in the display.

To release the unoccupied function, press the UNOCCUPIED button again.

Unoccupied Indication

Unoccupied Function	Unoccupied Indication	Status
OFF	no display	The unoccupied function is not set.
ON	flashing	The unoccupied function is now being set, and under Heating (or Cooling) operation.
	lighting	Although the unoccupied function is set, not under Heating (or Cooling) operation.

NOTE

Even if Unoccupied Mode is ON, it will be disabled if the air conditioner is in operation.

- Unoccupied Function can be set and released through all operational modes, regardless of whether the air conditioner is operating or not.
- If the Unoccupied Function is ON and the remote controller is used to turn the air conditioner OFF (including OFF TIMER), the air conditioner will turn off, but depending on the room temperature, Heating or Cooling Operation will automatically begin.
- When the Unoccupied Function is in operation and the ON/OFF operation button is pressed, operation will restart based on the settings input before the air conditioner was turned off.

A. In Heating Mode: (☀)

- (1) When the room temperature drops below 46°F, Heating Operation will begin.
- (2) When the room temperature rises to above 53°F, Heating Operation will stop.

The above actions will repeat so that the room temperature is maintained at about 50°F.

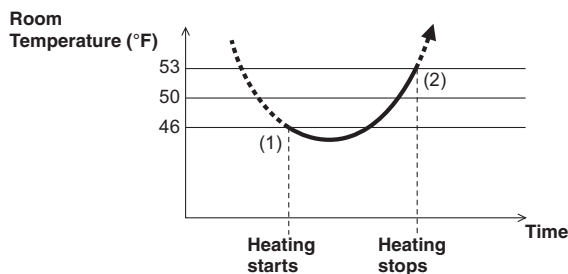

B. In Cooling Mode: (❄)

- (1) When the room temperature rises above 89°F, Cooling Operation will begin.
- (2) When the room temperature drops below 82°F, Cooling Operation will stop.

The above actions will repeat so that the room temperature is maintained at about 86°F.

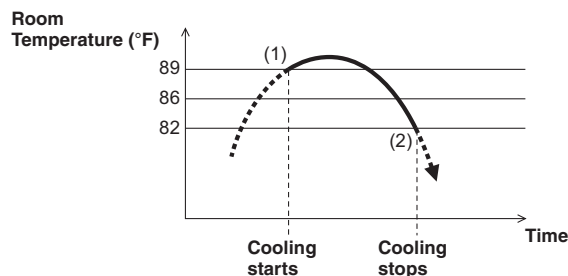

- Unoccupied Mode triggers Heating or Cooling Operation in response to the room temperature, but when this happens, the remote controller will continue to display the Operation mode set by the user.
- If the room temperature rapidly changes, the room temperature may get over the upper or lower limit when the unoccupied function is activated.

NOTE

- The remote controller should be used in the location specified in "REMOTE CONTROLLER INSTALLATION POSITION" on page 8.
- The air conditioner's stop order (stated in (2) / above) is valid only when the unoccupied function is operated.

SPECIAL REMARKS

"DRY" (💧) Operation

How it works?

- Once the room temperature reaches the level that was set, the unit's operation frequency is changed automatically.
- During DRY operation, the fan speed automatically runs at lower speed for providing a comfortable breeze.
- "DRY" operation is not possible if the indoor temperature is 59 °F or less.

Heating (☀) Operation

Heating performance

- When High power operation , Fan speed Automatic operation , HIGH or MEDIUM has been changed to Fan speed LOW , Quiet operation **QUIET** or Night Setback , the fan speed may not be reduced to the desired setting immediately but rather it may be reduced slowly in steps due to the operating status of the air conditioner. (A maximum of 5 minutes are required for the change to be completed.)
- Because this air conditioner heats a room by drawing in the heat of the outside air (heat pump system), the heating efficiency will fall off when the outdoor temperature is very low. If sufficient heat cannot be obtained with this air conditioner, use another heating appliance together with it.

Defrosting

- When the outdoor temperature is low, frost or ice may form on the heat exchanger coil, reducing heating performance. When this happens, a microcomputer defrosting system operates. At the same time, the fan on the indoor unit stops and the OPERATION lamp lights red and orange alternately until defrosting is completed. Heating operation restarts after several minutes. (This interval will vary slightly depending upon the outdoor temperature and the way in which frost forms.)

Cold draft prevention

- For several minutes after the start of heating operation, the indoor fan runs at a lower speed until the indoor heat exchanger coil has warmed up sufficiently. However, the fan may remain stopped when the room temperature is low. This is because the COLD DRAFT PREVENTION SYSTEM is in operation.

Cooling (❄) operation

- Sometimes the indoor unit may not get to the set fan speed such as LOW under cool operation at very low outdoor temperatures due to the indoor unit being protected from ice or frost.

Power failure during operation

- In the event of power failure, the unit will stop. When the power is resumed, the unit will restart automatically in approximately 5 minutes by the remote controller. If the remote controller is on and left in a location where the unit can receive a signal, then the unit will automatically restart in approximately 5 minutes of power being restored.

Clicking Sound

Clicking sound is heard from the air conditioner

- In heating or cooling operation, any plastic parts may expand or shrink due to a sudden temperature change. In this event, a clicking sound may occur. This is normal, and the sound will soon disappear.

Remote Controller

- The remote controller sends the setting condition to the air conditioner regularly at five minute intervals.

SETTING THE TIMER

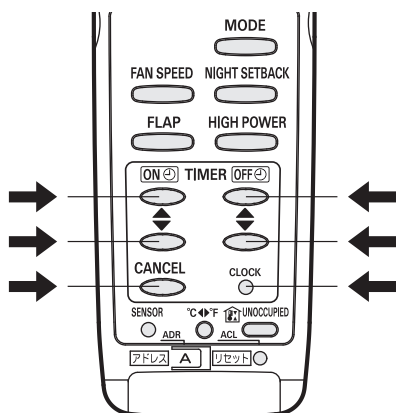

NOTE

In the descriptions below, the following settings are used for the temperature and time indicator selector button on the bottom front section of the remote controller.

- Temperature: °F
- Time: AM, PM

1. How to set the present time

(Example) To set to 10:30 pm.

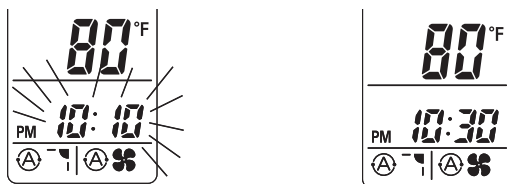

Operation	Indication
1. Press the CLOCK button once if the time indicator is not flashing.	The time indication alone flashes.
2. Press the Advance, Return (▲, ▼) button until PM 10:30 is displayed.	The time can be set in 1-minute increments. Holding down the button advances the time rapidly in 10-minute increments.
3. Press the CLOCK button again.	This completes the setting of the current time.

2. How to set the OFF time

(Example) To stop the air conditioner at 11:00 am.

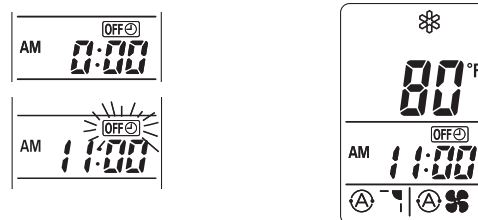

Operation	Indication
1. Press the OFF TIME setting button once.	The timer OFF TIME indication is displayed, and the present OFF time is shown.
2. Press the Advance, Return (▲, ▼) button until AM 11:00 is displayed.	The timer OFF TIME indication blinks. The time can be set in 10-minute increments. Holding down the button advances the time rapidly in 10-minute increments.
3. Wait a few seconds, and then the setting is complete.	The timer OFF TIME indication stops blinking and the present time is displayed.

3. How to set the ON time

(Example) To start operation at 7:10 am.

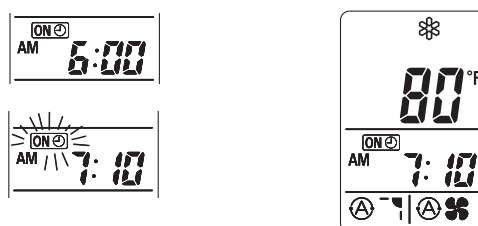

Operation	Indication
1. Press the ON TIME setting button once.	The timer ON TIME indication is displayed, and the present ON time is shown.
2. Press the Advance, Return (▲, ▼) button until AM 7:10 is displayed.	The timer ON TIME indication blinks. The time can be set in 10-minute increments. Holding down the button advances the time rapidly in 10-minute increments.
3. Wait a few seconds, and then the setting is complete.	The timer ON TIME indication stops blinking and the present time is displayed.

EG

4. How to set daily ON/OFF repeat timer

(Example) To start operation at 7:10 am. and stop the air conditioner at 11:00 am.

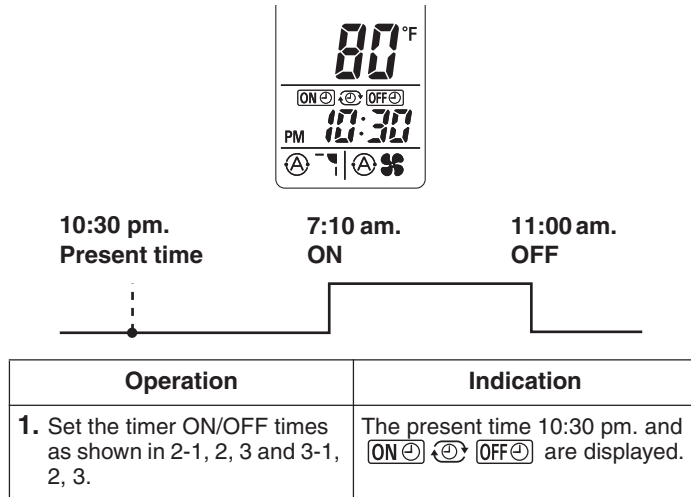

NOTE

- The ON/OFF combination timer uses the current time as the reference, and it is activated starting from whichever set time comes first.
- With the ON/OFF combination timer, the settings are repeated every day.
- You can check the timer ON/OFF times after you have set them by pressing the ON TIME and OFF TIME setting buttons.

To cancel a timer program

- Press the CANCEL button.
- When either an ON or OFF timer is to be canceled, press the button corresponding to the timer whose program is to be canceled, and then press the CANCEL button.

NOTE

- The airflow direction, fan speed and temperature setting can be changed after a timer program has been set even when the unit is stopped. Even when operation is stopped during an ON timer program, the unit will start operating when the set time is reached provided that the program is not canceled.
- When the ON timer and OFF timer are set to the same time, the timer operates as if it is turned off.

USING THE 1-HOUR OFF TIMER

1. 1-Hour OFF Timer

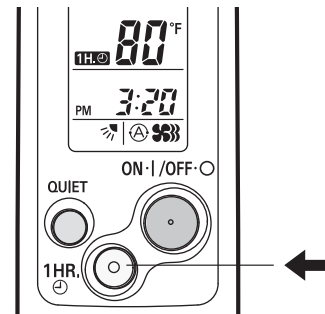

This function causes the unit to operate for one hour and then stop, regardless of whether the unit is on or off when this button is pressed.

The indicator in the display indicates that this function is operating.

Setting procedure:

Regardless of whether the unit is operating or stopped, press the 1 HR. TIMER button.

appears in the display.

Cancellation procedure:

Press the ON/OFF operation button to turn the unit off, wait for the unit to stop operating, and then press the ON/OFF operation button again.

The 1-Hour Timer function is now cancelled and the unit operates normally.

NOTE

- If, while the 1-Hour Timer function is operating, the 1HR. TIMER button is pressed once to cancel the function and then again, the unit continues to operate for one hour from that point in time and then stops.
- It is not possible to use the OFF Timer and 1-Hour OFF Timer together. Whichever function is set last takes precedence. If the 1 HR. TIMER button is pressed while the TIMER OFF function operates, the OFF Timer is cancelled and the unit will stop operating one hour later.

2. Operation together with the daily ON/OFF repeat timer

The 1-Hour OFF Timer setting is given priority over the DAILY ON/OFF REPEAT setting.

TIPS FOR ENERGY SAVING

Avoid

- Do not block neither the air intake nor the air outlet. It may cause less performance, and may leads to malfunctions.
- Do not let direct sunlight into the room. Use sunshades, blinds or curtains. If the walls and ceiling of the room are warmed by the sun, it will take longer to cool the room.

Do

- Always try to keep the air filter clean. (Refer to "CARE AND CLEANING".) A clogged filter will impair the performance of the unit.
- To prevent conditioned air from escaping, keep windows, doors and any other openings closed.

ADJUSTING THE AIRFLOW DIRECTION

1. Horizontal

The horizontal airflow can be adjusted by moving the vertical vanes with your hands to the left or right.

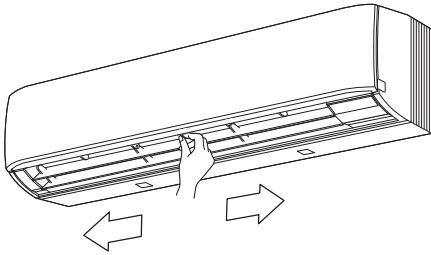

When the humidity is high, the vertical vanes should be in the front position during the cooling or dehumidifying operation. If the vertical vanes are positioned all of the way to the right or left, condensation may begin to form around the air vent and drip down.

2. Vertical

The vertical airflow can be adjusted by moving the flap with the remote controller. Do not move the flap with your hands. Confirm that the remote controller has been turned on. Use the FLAP button to set either the sweep function or one of the six airflow direction settings.

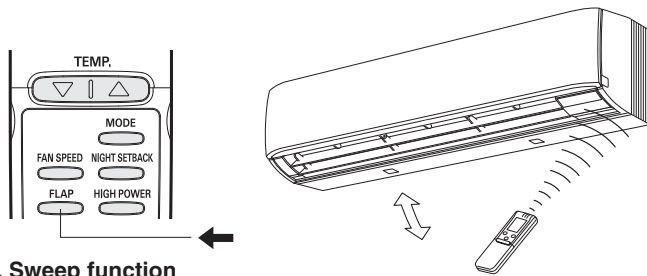

A. Sweep function



The flap starts moving up and down to deliver air over the sweep range.

B. Setting the airflow manually



Referring to the above illustration, use the FLAP button to set the airflow direction within the range used during the heating, cooling, or dehumidifying operation.

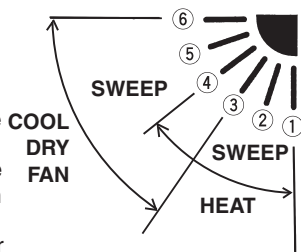

C. Auto flap function



The flap is set to the recommended position.

NOTE

- The flap automatically closes when the unit is off.
- During the heating operation, the fan speed will be very low and the flap will be in the horizontal position (position ⑥) until the air being blown out of the unit begins to warm. Once the air warms up, the flap position and fan speed change to the settings specified with the remote controller.



CAUTION

- Use the FLAP button on the remote controller to adjust the position of the flap. If you move the flap by hand, the flap position according to the remote controller and the actual flap position may no longer match. If this should happen, shut off the unit, wait for the flap to close, and then turn on the unit again; the flap position will now be normal again.
- Do not have the flap pointed down during cooling operation. Condensation may begin to form around the air vent and drip down.

OPERATION WITHOUT THE REMOTE CONTROLLER

INDOOR UNIT

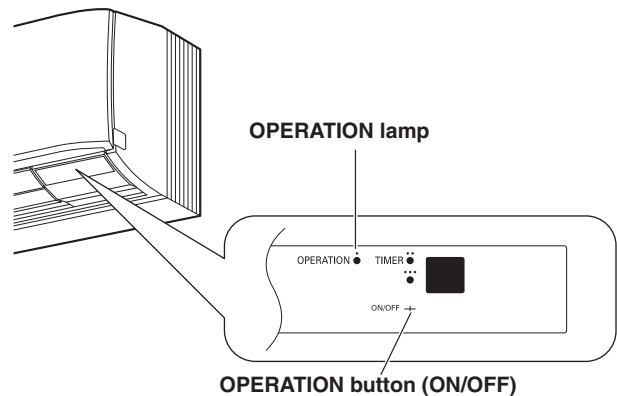

If you have lost the remote controller or it has trouble, follow the steps below.

When the air conditioner is not running

Each time the OPERATION button is pressed, the type of operation conducted is indicated by the changing color of the OPERATION lamp. Press the button and select the lamp color that suits your preference for operation.

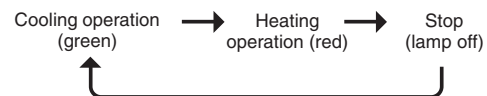

NOTE

The temperature is set to the room temperature minus 4°F during the cooling operation and to the room temperature plus 4°F during the heating operation, and the fan speed and flap are set to Auto.

CARE AND CLEANING



WARNING

1. For safety, be sure to turn the air conditioner off and also to disconnect the power before cleaning.
2. Do not pour water on the indoor unit to clean it. This will damage the internal components and cause an electric shock hazard.

Casing and Grille (Indoor Unit)

Clean the casing and grille of the indoor unit with a vacuum cleaner brush, or wipe them with a clean, soft cloth.

If these parts are stained, use a clean cloth moistened with a mild liquid detergent. When cleaning the grille, be careful not to force the vanes out of place.



CAUTION

1. Never use solvents, or harsh chemicals when cleaning the indoor unit. Do not wipe the plastic casing using very hot water.
2. Some metal edges and the fins are sharp and may cause injury if handled improperly; be especially careful when you clean these parts.
3. The internal coil and other components of the outdoor unit must be cleaned every year. Consult your dealer or service center.

Filter

The filter behind the front panel should be checked and cleaned at least once every two weeks.

How to remove the filter

1. Grasp both ends of the front panel and pull forward and up to open the front panel.

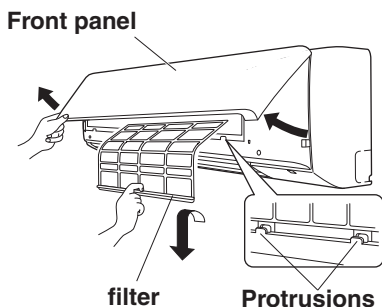

2. Lift the filter up slightly to disengage it from the protrusions on the unit.
3. Pull downward to remove the filter from the unit.

Cleaning

Use a vacuum cleaner to remove light dust. If there is sticky dust on the filter, wash the filter in lukewarm, soapy water, rinse it in clean water, and dry it.

How to replace the filter

1. Insert the top of the filter, and then secure the bottom of the filter with the protrusions on the unit.
2. Close the front panel by pushing the center of the front panel and then pressing both edges until the panel clicks into place.

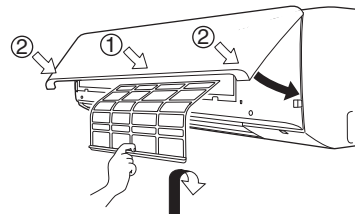

Cleaning the main unit and Remote Controller

- Wipe clean using a soft, dry cloth.
- To remove stubborn dirt, moisten a cloth in warm water no hotter than 104 °F, wring thoroughly, and then wipe.
- The front panel can be removed in order to wash it with water.

Removing and remounting the front panel

Removing

Open the front panel until it is nearly horizontal, grasp the sections near the front panel arms on both sides, and then remove the panel by pushing the arms towards the outside while pulling the panel towards you.

If the front panel is difficult to remove, grasp both ends of it and lift it up slightly.

Move it to the left and disengage the left arm, then move it to the right and disengage the right arm.

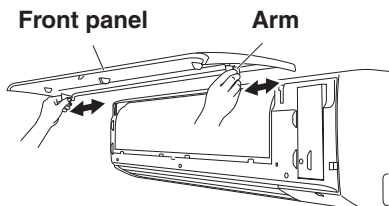

Remounting

Grasp the sections near the front panel arms on both sides, and hold the front panel so that it is nearly horizontal. Push the arm shafts towards the outside so that they come into contact with the top of the indentations on the right and left sides of the air conditioner. Then push firmly until the arm shafts click into place. After closing the front panel, press firmly on the parts indicated by the arrows to securely fasten the panel in place. Also refer to the figure that shows "How to replace the filter".



CAUTION

When using a footstool or the like, be careful not to let it tip over.

Washing the front panel with water

- Clean the front panel gently using a soft sponge, or the like. Then wipe away any remaining moisture.
- Neutral detergent may be used to remove stubborn dirt. Then rinse thoroughly with water and wipe away any remaining moisture.

TROUBLESHOOTING (BEFORE CALLING FOR SERVICE)

If your air conditioner does not work properly, first check the following points before requesting service. If it still does not work properly, contact your dealer or service center.

Trouble	Possible Cause	Remedy
Air conditioner does not run at all.	<ol style="list-style-type: none"> 1. Power failure. 2. Leakage circuit breaker tripped. 3. Line voltage is too low. 4. Batteries in remote controller have run down. 	<ol style="list-style-type: none"> 1. Restore power. 2. Contact service center. 3. Consult your electrician or dealer. 4. Replace batteries.
OPERATION lamp blinks and air conditioner does not operate.	Trouble in system.	Contact service center.
Compressor runs but soon stops.	Obstruction in front of condenser coil. (Outdoor Unit)	Remove obstruction.
Poor cooling (or heating) performance.	<ol style="list-style-type: none"> 1. Dirty or clogged air filter. 2. Heat source or many people in room. 3. Doors and/or windows are open. 4. Obstacle near air intake or air discharge port. 5. Thermostat is set too high for cooling (or too low for heating). 6. (Outdoor temperature is too low for heating.) 	<ol style="list-style-type: none"> 1. Clean air filter to improve airflow. 2. Eliminate heat source if possible. 3. Shut them to keep the heat (or cold) out. 4. Remove it to ensure good airflow. 5. Set the temperature lower (or higher). 6. (Consult your dealer or try to use another heat appliance.)
Clicking sound is heard from the air conditioner.	In heating or cooling operation, any plastic parts may expand or shrink due to a sudden temperature change. In this event, a clicking sound may occur.	This is normal, and the sound will soon disappear.
OPERATION lamp lights but outdoor unit will not run.	The use of cellular phones near the air conditioner may cause disturbance to its normal operation.	<ol style="list-style-type: none"> 1. Turn off the power then restart the air conditioner after a while. 2. Consult your dealer.

OPERATING RANGE

The air conditioner is operable within the temperature ranges as listed below:

	Temperature	Indoor air temperature	Outdoor air temperature
COOLING	Max.	95 °F DB / 71 °F WB	115 °F DB
	Min.	67 °F DB / 57 °F WB	0 °F DB
HEATING	Max.	80 °F DB / 67 °F WB	75 °F DB / 65 °F WB
	Min.	- DB / - WB	- DB / 0 °F WB

WIRED REMOTE CONTROLLER

A separately sold wired remote controller (CZ-RD515U) used with this air conditioner is also available. If you wish to use the wired remote control function, you will need to purchase both the optional wired remote controller and its connection kit (CZ-RC515UA).

EG

SPECIFICATIONS

Model No.			Outdoor Unit		Indoor Unit	
			CU-KE30NKU		CS-KE30NKU	
Power Source			Single-phase, 208-230 V, 60 Hz			
Cooling Capacity		kW		9.00 [3.20 ~ 9.00]		
		BTU/h		30,600 [10,900 ~ 30,600]		
Heating Capacity		kW		9.70 [4.10~9.70]		
		BTU/h		33,000 [14,000~33,000]		
Operation Sound	Cooling Operation	Outdoor (Hi)	dB(A)	55		
		Indoor(H/M/L)		-		
	Heating Operation	Outdoor (Hi)	dB(A)	55		
		Indoor(H/M/L)		-		
Unit Dimensions (HxWxD) (Indoor unit : Include panel)		inch(mm)	35-13/16x37-1/32x13-3/8 (910x940x340)		11-13/16x41-15/16x9-1/16 (300x1065x230)	
Net Weight		lbs.(kg)	185.2(84.0)		32.0(14.5)	

Model No.			Outdoor Unit		Indoor Unit	
			CU-KE36NKU		CS-KE36NKU	
Power Source			Single-phase, 208-230 V, 60 Hz			
Cooling Capacity		kW		10.00 [3.20 ~ 10.00]		
		BTU/h		34,000 [10,900 ~ 34,000]		
Heating Capacity		kW		10.50 [4.10~10.50]		
		BTU/h		36,000 [14,000~36,000]		
Operation Sound	Cooling Operation	Outdoor (Hi)	dB(A)	55		
		Indoor(H/M/L)		-		
	Heating Operation	Outdoor (Hi)	dB(A)	55		
		Indoor(H/M/L)		-		
Unit Dimensions (HxWxD) (Indoor unit : Include panel)		inch(mm)	35-13/16x37-1/32x13-3/8 (910x940x340)		11-13/16x41-15/16x9-1/16 (300x1065x230)	
Net Weight		lbs.(kg)	185.2(84.0)		32.0(14.5)	

APPENDIX B INSTALLATION INSTRUCTIONS

CS-KE30NKU + CU-KE30NKU
CS-KE36NKU + CU-KE36NKU

(852-6-4190-587-00-0)

INSTALLATION INSTRUCTIONS

Split System Air Conditioner

This air conditioner uses the refrigerant R410A.

NOTE External diameter of service port R410A: 5/16"

Contents

Page

Model Combinations

Combine indoor and outdoor units only as listed below.

Model No.

<u>Indoor Unit</u>	—————	<u>Outdoor Unit</u>
CS-KE30NKU	—————	CU-KE30NKU
CS-KE36NKU	—————	CU-KE36NKU

Power Source:
60 Hz, single-phase, 230/208 V

IMPORTANT!

Please Read Before Starting 2

1. GENERAL	4
1-1. Tools Required for Installation (not supplied)	
1-2. Accessories Supplied with Unit	
1-3. Optional Copper Tubing Kit	
1-4. Type of Copper Tube and Insulation Material	
1-5. Additional Materials Required for Installation	
2. INSTALLATION SITE SELECTION	5
2-1. Indoor Unit	
2-2. Outdoor Unit	
3. HOW TO INSTALL THE INDOOR UNIT	13
3-1. Remove the Rear Panel from the Unit	
3-2. Make a Hole	
3-3. Install the Rear Panel on the Wall	
3-4. Removing and Installing the Grille	
3-5. Shape the Indoor Side Tubing	
3-6. Wiring Instructions	
3-7. Wire Size and Length	
3-8. Wiring Instructions for Inter-unit Connections	
3-9. Mounting	
3-10. Frame Fastening Method	
3-11. Drain Hose	
4. HOW TO INSTALL THE OUTDOOR UNIT	23
4-1. Wiring Instructions for the Outdoor Unit	
4-2. Routing the Tubing and Wiring	
5. REFRIGERANT TUBING	24
5-1. Use of the Flaring Method	
5-2. Flaring Procedure with a Flare Tool	
5-3. Caution before Connecting Tubes Tightly	
5-4. Connecting Tubing between Indoor and Outdoor Units	
5-5. Insulation of Refrigerant Tubing	
5-6. Taping the Tubes	
5-7. Finishing the Installation	
6. AIR PURGING	26
■ Air Purging with a Vacuum Pump (for Test Run)	
■ Basic Functions of the Service Valves	
■ Pump Down	
■ Service Valve Connections	
7. REMOTE CONTROLLER INSTALLATION POSITION	30
7-1. Mounting on a Wall	
8. ADDRESS SWITCH	31
8-1. Address Setting of the Remote Controller	

IMPORTANT!

Please Read Before Starting

This air conditioning system meets strict safety and operating standards. As the installer or service person, it is an important part of your job to install or service the system so it operates safely and efficiently.

For safe installation and trouble-free operation, you must:

- Carefully read this instruction booklet before beginning.
- Follow each installation or repair step exactly as shown.
- Observe all local, state, and national electrical codes.
- Pay close attention to all warning and caution notices given in this manual.



WARNING

This symbol refers to a hazard or unsafe practice which can result in severe personal injury or death.



CAUTION

This symbol refers to a hazard or unsafe practice which can result in personal injury or product or property damage.

If Necessary, Get Help

These instructions are all you need for most installation sites and maintenance conditions. If you require help for a special problem, contact our sales/service outlet or your certified dealer for additional instructions.

In Case of Improper Installation

The manufacturer shall in no way be responsible for improper installation or maintenance service, including failure to follow the instructions in this document.

SPECIAL PRECAUTIONS

WARNING When Wiring



ELECTRICAL SHOCK CAN CAUSE SEVERE PERSONAL INJURY OR DEATH. ONLY A QUALIFIED, EXPERIENCED ELECTRICIAN SHOULD ATTEMPT TO WIRE THIS SYSTEM.

- Do not supply power to the unit until all wiring and tubing are completed or reconnected and checked.
- Highly dangerous electrical voltages are used in this system. Carefully refer to the wiring diagram and these instructions when wiring. Improper connections and inadequate grounding can cause **accidental injury or death**.
- **Ground the unit** following local electrical codes.
- Connect all wiring tightly. Loose wiring may cause overheating at connection points and a possible fire hazard.
- To prevent possible hazards from insulation failure,  the unit must be grounded.

When Transporting

Be careful when picking up and moving the indoor and outdoor units. Get a partner to help, and bend your knees when lifting to reduce strain on your back. Sharp edges or thin aluminum fins on the air conditioner can cut your fingers.

When Installing...

Select an installation location which is rigid and strong enough to support or hold the unit, and select a location for easy maintenance.

...In a Ceiling or Wall

Make sure the ceiling/wall is strong enough to hold the unit's weight. It may be necessary to construct a strong wood or metal frame to provide added support.

...In a Room

Properly insulate any tubing run inside a room to prevent "sweating" that can cause dripping and water damage to walls and floors.



CAUTION

Keep the fire alarm and the air outlet at least 1.5 m away from the unit.

...In Moist or Uneven Locations

Use a raised concrete pad or concrete blocks to provide a solid, level foundation for the outdoor unit. This prevents water damage and abnormal vibration.

...In an Area with High Winds

Securely anchor the outdoor unit down with bolts and a metal frame. Provide a suitable air baffle.

...In a Snowy Area (for Heat Pump-type Systems)

Install the outdoor unit on a raised platform that is higher than drifting snow. Provide snow vents.

When Connecting Refrigerant Tubing



WARNING

- When performing piping work do not mix air except for specified refrigerant (R410A) in refrigeration cycle. It causes capacity down, and risk of explosion and injury due to high tension inside the refrigerant cycle.
- Refrigerant gas leakage may cause fire.
- Do not add or replace refrigerant other than specified type. It may cause product damage, burst and injury etc.
- Ventilate the room well, in the event that refrigerant gas leaks during the installation. Be careful not to allow contact of the refrigerant gas with a flame as this will cause the generation of poisonous gas.



- Use the flare method for connecting tubing.
- Apply refrigerant lubricant to the matching surfaces of the flare and union tubes before connecting them, then tighten the nut with a torque wrench for a leak-free connection.
- Check carefully for leaks before starting the test run.
- Do not leak refrigerant while piping work for an installation or re-installation, and while repairing refrigeration parts. Handle liquid refrigerant carefully as it may cause frost-bite.

When Servicing

- Turn the power OFF at the main power box (mains) before opening the unit to check or repair electrical parts and wiring. 
- Keep your fingers and clothing away from any moving parts.
- Clean up the site after you finish, remembering to check that no metal scraps or bits of wiring have been left inside the unit being serviced.

Others



- Ventilate any enclosed areas when installing or testing the refrigeration system. Escaped refrigerant gas, on contact with fire or heat, can produce dangerously toxic gas.
- Confirm upon completing installation that no refrigerant gas is leaking. If escaped gas comes in contact with a stove, gas water heater, electric room heater or other heat source, it can produce dangerously toxic gas.
- Do not touch the air inlet or the sharp aluminum fins of the outdoor unit. You may get injured. 
- Do not sit or step on the unit, you may fall down accidentally. 
- Do not stick any object into the FAN CASE. You may be injured and the unit may be damaged. 



NOTE

The illustrations are based on the typical appearance of a standard model. Consequently, the shape may differ from that of the air conditioner that you are installing.

1. General

This booklet briefly outlines where and how to install the air conditioning system. Please read over the entire set of instructions for the indoor and outdoor units and make sure all accessory parts listed are with the system before beginning.







1-1. Tools Required for Installation (not supplied)

1. Standard screwdriver
2. Phillips head screwdriver
3. Knife or wire stripper
4. Tape measure
5. Carpenter's level

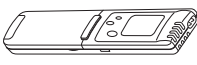
6. Sabre saw or key hole saw
7. Hacksaw
8. Core bits
9. Hammer
10. Drill
11. Tube cutter
12. Tube flaring tool
13. Torque wrench
14. Adjustable wrench
15. Reamer (for deburring)

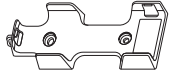
1-2. Accessories Supplied with Unit

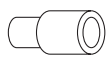
Table 1

Parts	Figure	Q'ty	Parts	Figure	Q'ty	Parts	Figure	Q'ty
Remote controller		1	Tapping screw	Truss-head Phillips 5/32 x 13/16" (4x20 mm) 	10	Rawl plug		8
Remote control holder		1	Tapping screw	Truss-head Phillips 5/32 x 13/32" (4x10 mm) 	2	Drain hose adapter		1
AAA alkaline battery		2	Flare insulation		1			

1-3. Optional Copper Tubing Kit

Copper tubing for connecting the outdoor unit to the indoor unit is available in kits which contain the narrow and wide tubing, fittings and insulation. Consult your nearest sales outlet or air conditioning workshop.

1-4. Type of Copper Tube and Insulation Material

If you wish to purchase these materials separately from a local source, you will need:

1. Deoxidized annealed copper tube for refrigerant tubing as detailed in Table 2.
Cut each tube to the appropriate lengths 1' to 1'4" (30 cm to 40 cm) to dampen vibration between units.

2. Foamed polyethylene insulation for the specified copper tubes as required to precise length of tubing. Wall thickness of the insulation should be not less than 5/16" (8 mm).
3. Use insulated copper wire for field wiring. Wire size varies with the total length of wiring. Refer to 3-6. Wiring Instructions for details.



Check local electrical codes and regulations before obtaining wire. Also, check any specified instructions or limitations.

Table 2

Model	Narrow Tube		Wide Tube	
	Outer Dia.	Thickness	Outer Dia.	Thickness
CS-KE30NKU	3/8" (9.52 mm)	0.0314" (0.8 mm)	5/8" (15.88 mm)	0.0393" (1.0 mm)
CS-KE36NKU	3/8" (9.52 mm)	0.0314" (0.8 mm)	5/8" (15.88 mm)	0.0393" (1.0 mm)

1-5. Additional Materials Required for Installation

1. Refrigeration (armored) tape
2. Insulated staples or clamps for connecting wire
(See local codes.)
3. Putty
4. Refrigeration lubricant
5. Clamps or saddles to secure refrigerant tubing

2. Installation Site Selection

2-1. Indoor Unit



WARNING

To prevent abnormal heat generation and the possibility of fire, do not place obstacles, enclosures and grilles in front of or surrounding the air conditioner in a way that may block air flow.

AVOID:

- direct sunlight.
- nearby heat sources that may affect performance of the unit.
- areas where leakage of flammable gas may be expected.
- places where large amounts of oil mist exist.

DO:

- select an appropriate position from which every corner of the room can be uniformly cooled. (High on a wall is best.)
- select a location that will hold the weight of the unit.
- select a location where tubing and drain hose have the shortest run to the outside. (Fig. 1)
- allow room for operation and maintenance as well as unrestricted air flow around the unit. (Fig. 2)
- install the unit within the maximum elevation difference (H) above or below the outdoor unit and within the maximum tubing length (L) from the outdoor unit as detailed in Table 3 and Fig. 3a.
- install the indoor unit more than 3.3' (1 m) away from any antenna or power lines or connecting wires used for television, radio, telephone, security system, or intercom. Electrical noise from any of these sources may affect operation.

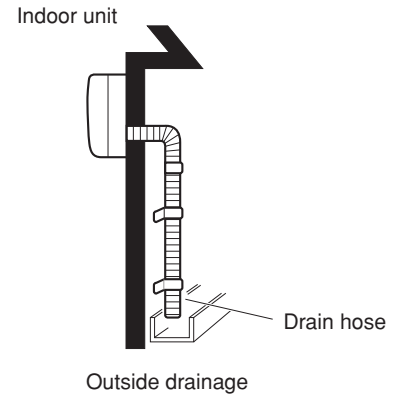
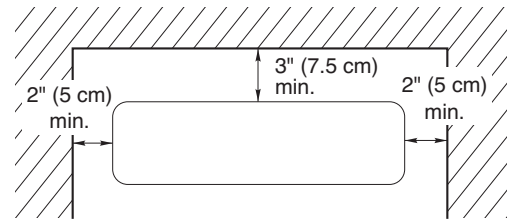

Fig. 1



Front View

Fig. 2

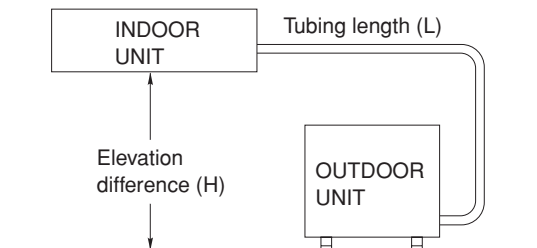

Fig. 3a



CAUTION

For stable operation of the air conditioner, do not install wall-mounted type indoor units less than 5' (1.5 m) from floor level.

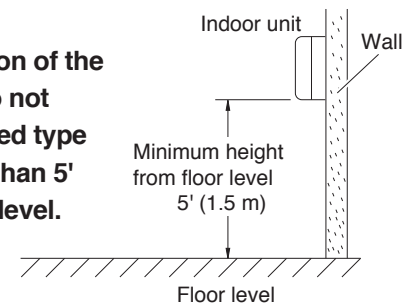

Fig. 3b

Table 3

Model	Charge-less Tubing Length (Actual Length) (ft.)	Maximum Tubing Length (L) (ft.)	Maximum Elevation Difference (H) (ft.)		Required Amount of Additional Refrigerant (oz./ft.)*
CS-KE30NKU CS-KE36NKU	10 to 100	164	If the outdoor unit is higher	100	0.43
			If the outdoor unit is lower	50	

* If total tubing length becomes 100 to 164 ft. (Max.), charge additional refrigerant (R410A) by 0.43 oz./ft.
No additional charge of compressor oil is necessary. For more detailed charging information, refer to the Technical & Service Manual.

2-2. Outdoor Unit

AVOID:

- heat sources, exhaust fans, etc. (Fig. 4)
- damp, humid or uneven locations.

DO:

- choose a place as cool as possible.
- choose a place that is well ventilated.
- install in a location where at least two sides are unobstructed, so that the flow of air at the intake port or exhaust port is not blocked, and so that sufficient space is ensured for maintenance to be carried out without trouble. In general the top also must be unobstructed. (Fig. 5a)
- provide a solid base (level concrete pad, concrete block, 6" x 1'4" (15 x 40 cm) beams or equal), a minimum of 6" (15 cm) above ground level to reduce humidity and protect the unit against possible water damage and decreased service life. (Figs. 5b and 5c)



CAUTION

A solid base must not cover the hole of the bottom plate.

- install cushion rubber under unit's feet to reduce vibration and noise. (Fig. 5d)
- use lug bolts or equal to bolt down unit, reducing vibration and noise.
- install in a location where no antenna of a television or radio exists within 10' (3 m).

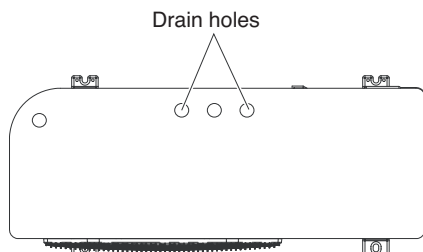

Fig. 5b

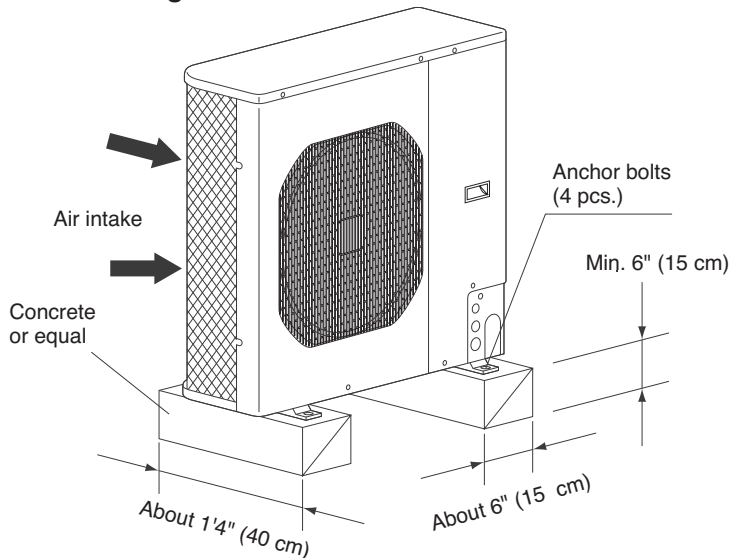

Fig. 5c

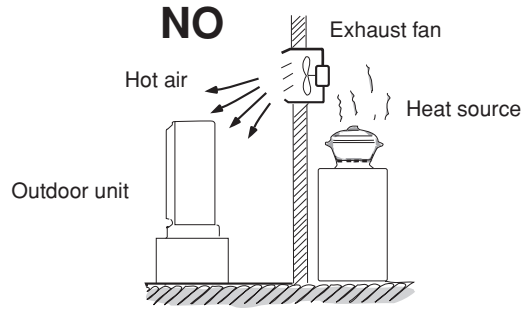

Fig. 4

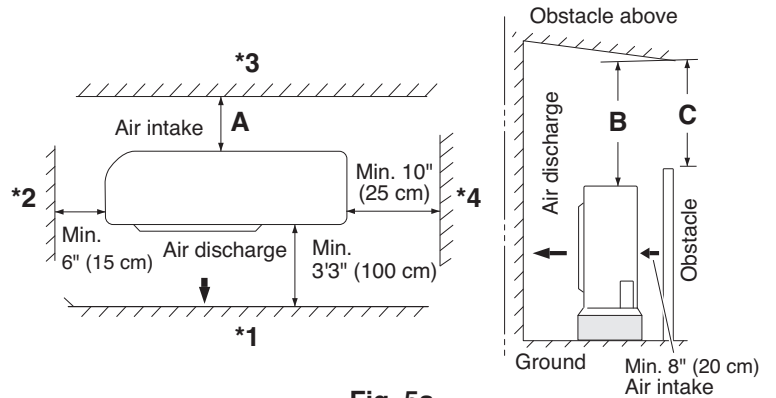

Fig. 5a



CAUTION

- Concerning air-intake side distance "A" (Fig. 5a) The minimum for distance "A" is 6" if there are no obstructions on the air-discharge side (wall *1 side) and *2 or *4 is not present. In all other cases, the minimum for distance "A" is 8".
- If wall *1 is on the air-discharge side (Fig. 5a), or if obstructions are present on all 3 sides *2, *3, and *4 (Fig. 5a), then the minimum distance for "B" and "C" is 39-3/8". Even if there is no wall on the air-discharge side, a minimum of 39-3/8" is required.

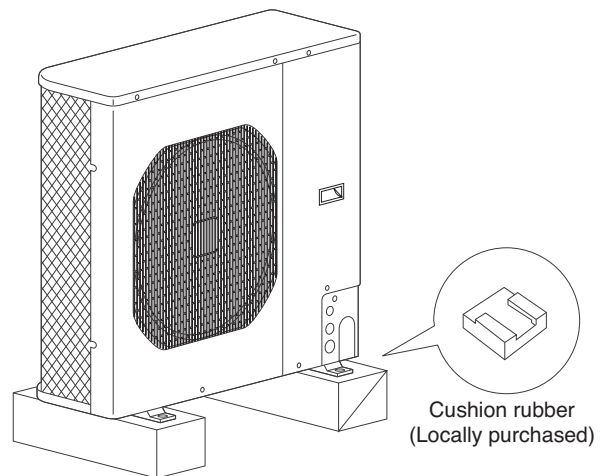

Fig. 5d

2-2-1. Installing the Unit in an Area with High Winds and in a Snowy Area

- In locations with high winds, a wind-proof duct should be fitted and direct exposure to the wind should be avoided as much as possible. (Fig. 5e)
- In regions with significant snowfall, the outdoor unit should be provided with a platform and snow-proof duct. (Fig. 5f)

■ Countermeasures against snow and wind

In regions with snow and strong wind, the following problems may occur when the outdoor unit is not provided with a platform and ducting:

- The outdoor fan may not run and damage to the unit may occur.
- There may be no air flow.
- The tubing may freeze and burst.
- The condenser pressure may drop because of strong wind, and the indoor unit may freeze.

2-2-2. Precautions for Installation in a Snowy Area

- The platform should be higher than the maximum snow depth. (Fig. 5g)
- The 2 anchoring feet of the outdoor unit should be used for the platform, and the platform should be installed beneath the air intake side of outdoor unit.
- The platform foundation must be firm and the unit must be secured with anchor bolts.
- In case of installation on a roof subject to strong wind, countermeasures must be taken to prevent the unit from being blown over.

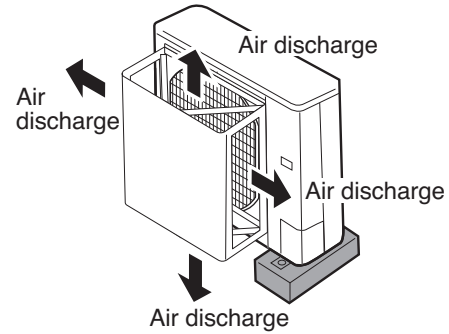

Fig. 5e

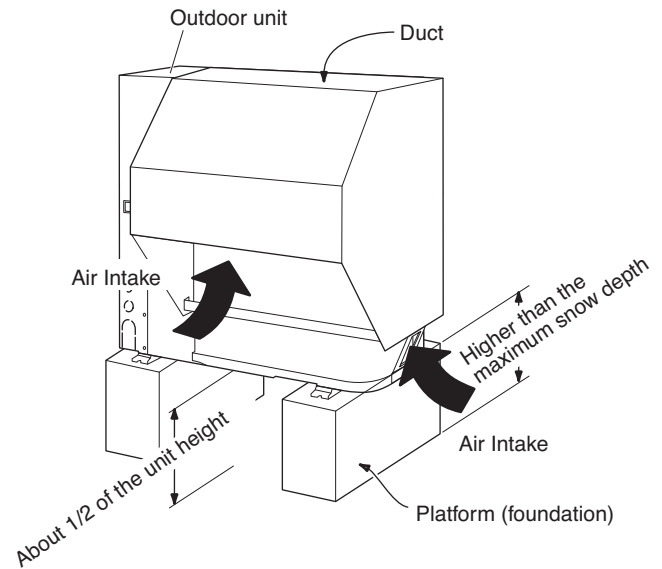

Fig. 5f

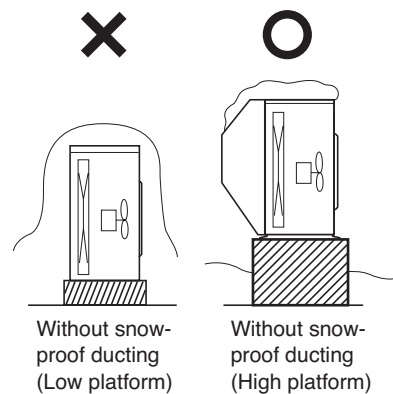
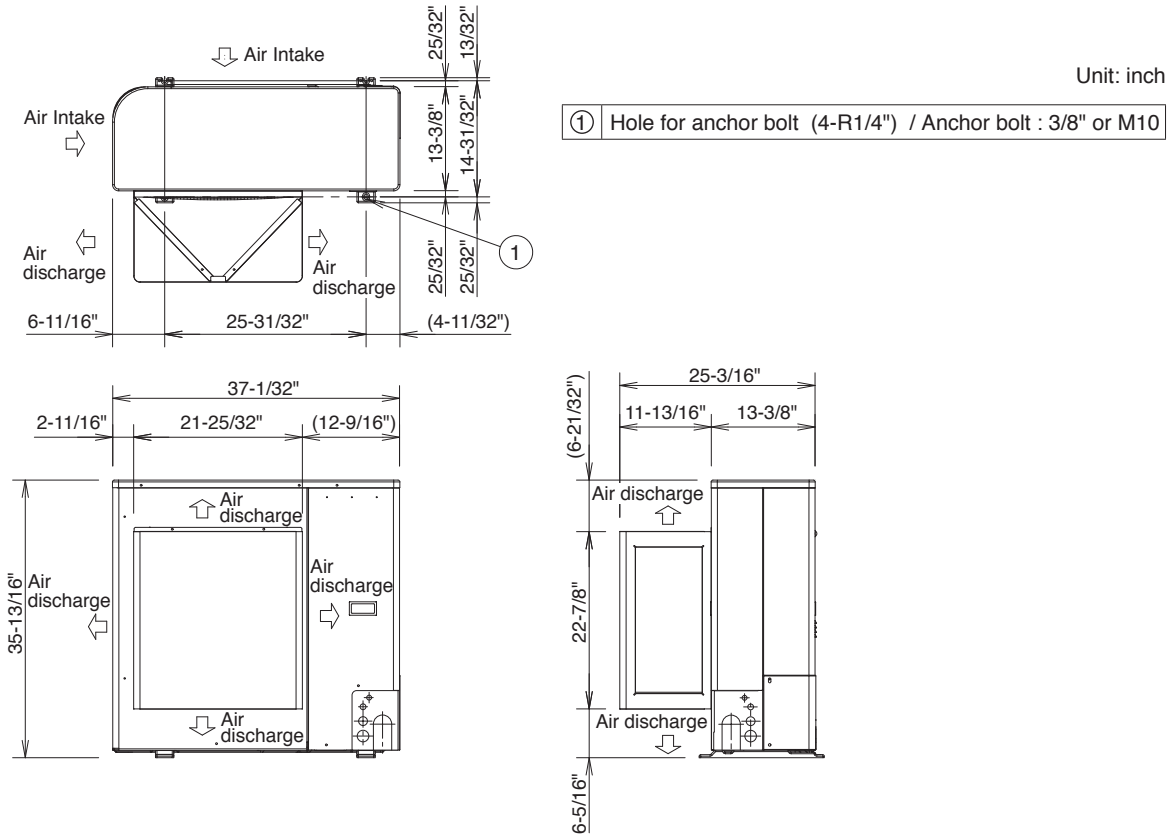

Fig. 5g

2-2-3. Dimensions of Wind-proof Duct

Reference diagram for CU-KE30NKU, CU-KE36NKU



Reference diagram for wind-proof duct (locally purchased): STK-DGV160E

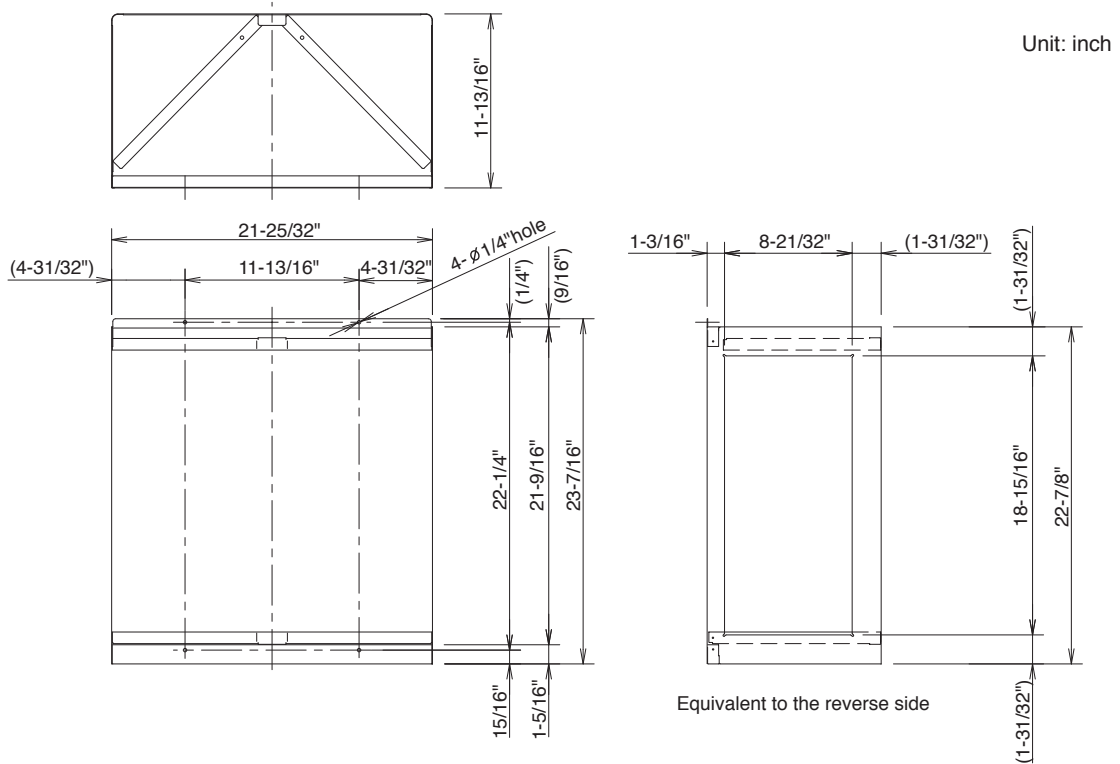

Required space around the outdoor unit

If the wind-proof duct is used, the space shown below must be secured around the outdoor unit.

If the unit is used without the required space, a protective device may activate, preventing the unit from operating.

(1) Single-unit installation

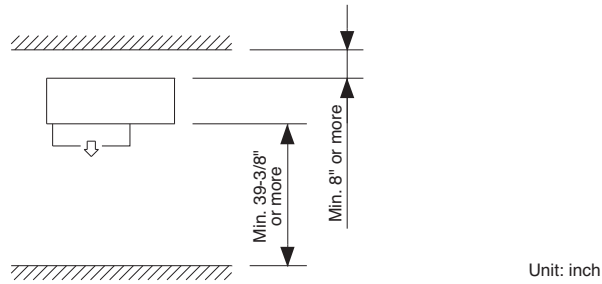

Unit: inch



CAUTION

The top and both sides must remain open. If there are obstacles to the front and rear of the outdoor unit, the obstacle at either the front or rear must be no taller than the height of the outdoor unit.

(2) Multiple-unit installation

● Installation in lateral rows

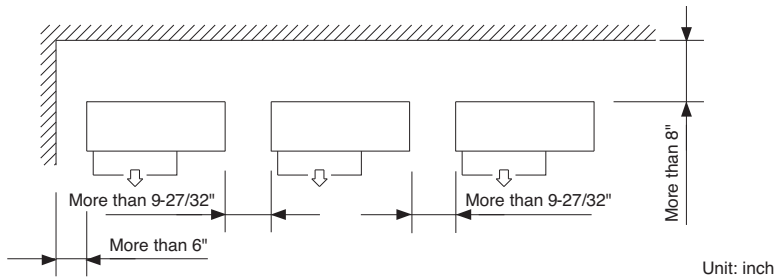

Unit: inch



CAUTION

The front and top must remain open. The obstacles must be no taller than the height of the outdoor unit.

● Installation in front-rear rows

Installation with intakes facing
intakes or outlets facing outlets

Installation with intakes facing outlets

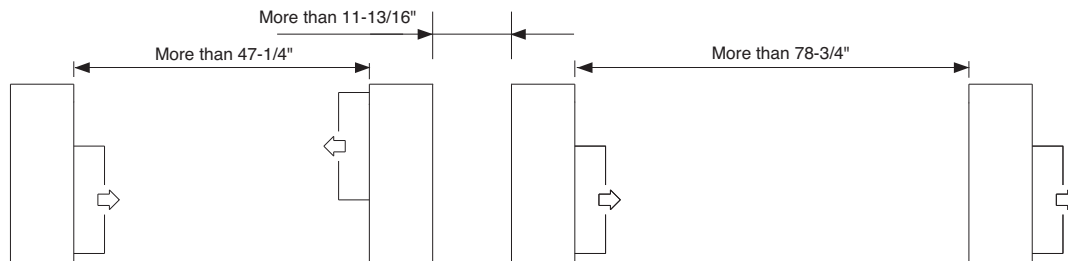

Unit: inch



CAUTION

The front and both sides must remain open.

Reference diagram for snow-proof duct

Space requirements for setting

CU-KE30NKU, CU-KE36NKU with STK-BDV80E

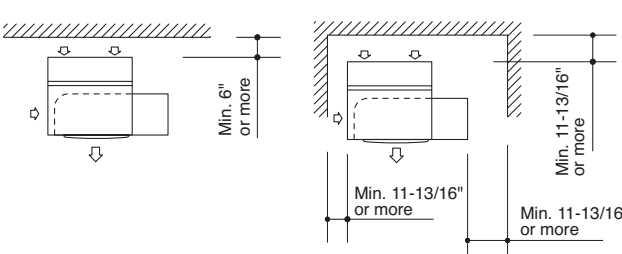
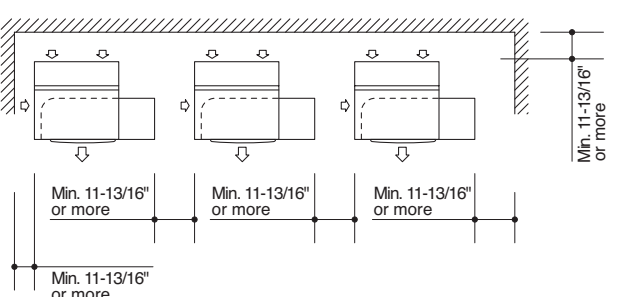
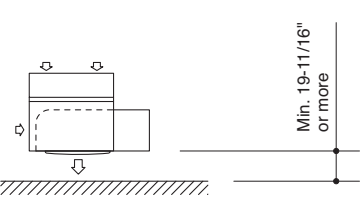
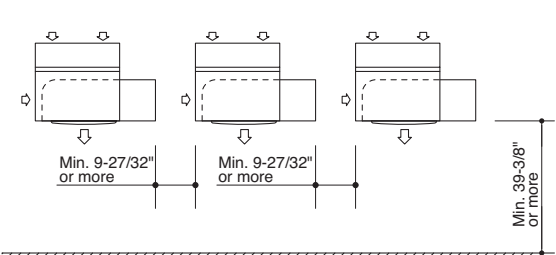
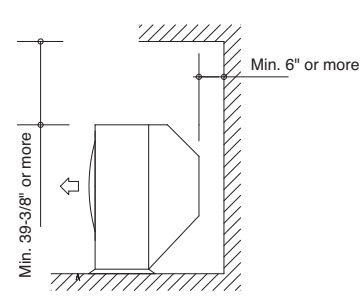
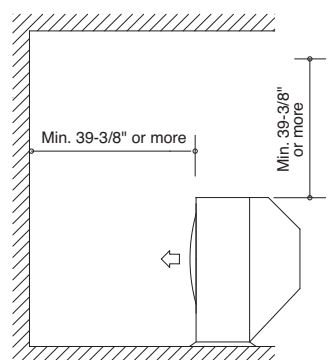
[Obstacle to the rear of unit]	[Obstacle to the front of unit]
<p>● Top is open:</p> <p>(1) Single-unit installation (2) Obstacles on both sides</p>  <p>(3) Multiple-unit installation (2 or more units)</p>  <p>Note: In cases 2 and 3 the height of the obstacle must be no taller than the height of the outdoor unit.</p>	<p>● Top is open:</p> <p>(1) Single-unit installation</p>  <p>(2) Multiple-unit installation (2 or more units)</p> 
<p>● Top is blocked by an obstacle:</p> 	<p>● Top is blocked by an obstacle:</p> 

[Obstacles to the front and rear of unit]

- The top and both sides must remain open. Either the obstacle to the front or the obstacle to the rear must be no taller than the height of the outdoor unit.

(1) Single-unit installation

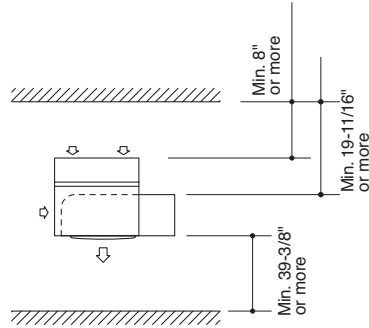

(2) Obstacles on both sides

Installation is possible with the maximum 3 outdoor units.

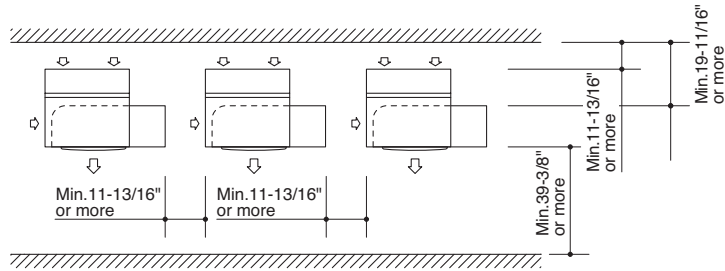

[Installation in front-rear rows]

- The top and both sides must remain open. Either the obstacle to the front or the obstacle to the rear must be no taller than the height of the outdoor unit.

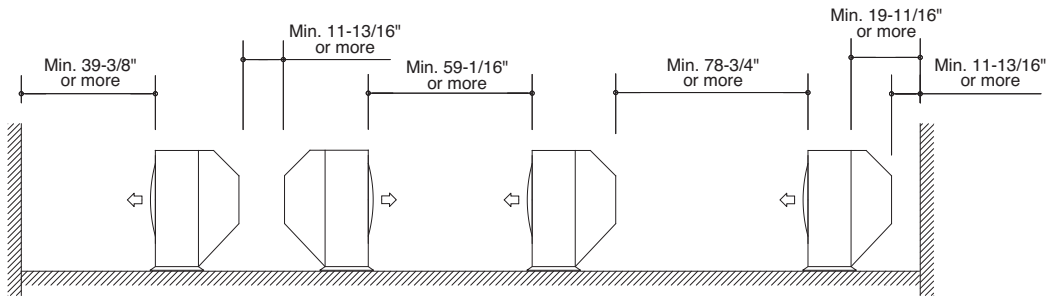

Unit: inch

3. How to Install the Indoor Unit

3-1. Remove the Rear Panel from the Unit

- (1) Remove and discard the set screw on the rear panel. (Fig. 6)
- (2) Press the 2 Δ marks on the frame cover and disengage the stationary tabs from the frame. (Fig. 7a)
- (3) Remove the rear panel by grasping the sections shown in Fig. 7b and pulling it in the direction shown by the arrow.

NOTE

Tubing can be extended in 6 directions as shown in Fig. 8. Select the direction you need providing the shortest run to the outside unit.

- When left tubing is to be done, switch the drain hose and drain cap. (For details, refer to "Switching drain hose and drain cap" on page 21.)

3-2. Make a Hole

- (1) Place the rear panel from the indoor unit on the wall at the location selected. Make sure the panel is horizontal, using a carpenter's level or tape measure to measure down from the ceiling. Wait until after cutting the hole before attaching the rear panel to the wall.
- (2) Determine which side of the unit you should make the hole for tubing and wiring. (Fig. 9)

NOTE

In the case of left-rear tubing, use the measurement points 6-7/32" (158 mm) from the marked position on the rear panel for precise placement of the hose outlet. (Fig. 9)

- (3) Before making the hole, check carefully that no studs or pipes are directly run behind the spot to be cut.



CAUTION

Also avoid areas where electrical wiring or conduits are located.

The above precautions are also applicable if tubing goes through the wall in any other location.

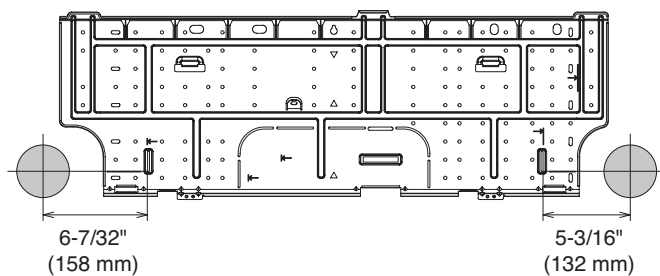
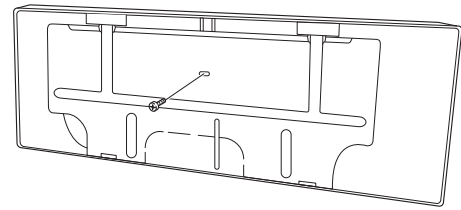

Fig. 9



Set screw only for transportation

Fig. 6

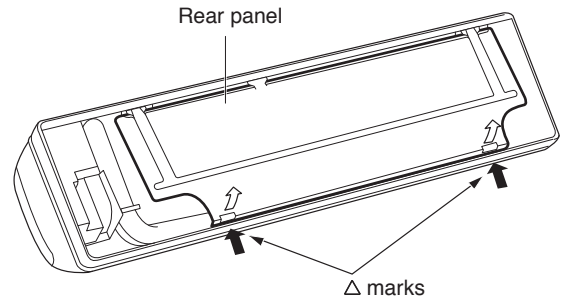

Fig. 7a

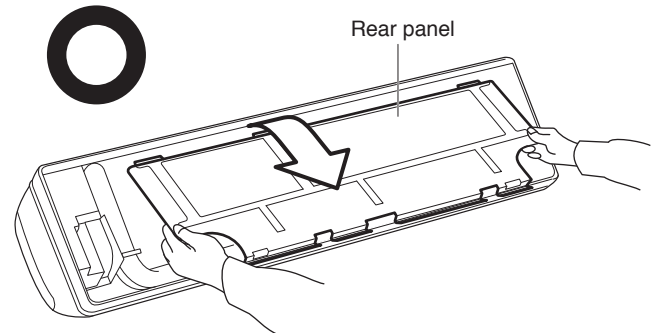

Fig. 7b

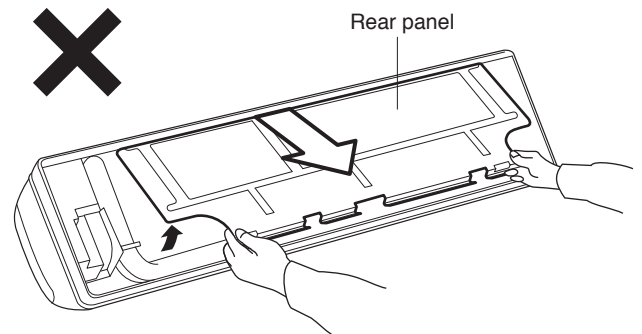

Fig. 7c

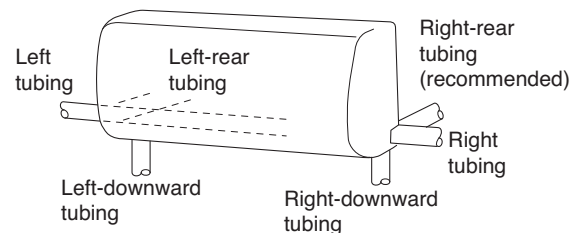

Fig. 8

- Using a sabre saw, key hole saw or hole-cutting drill attachment, cut a hole in the wall. See Table 4 and Fig. 10.

Table 4

Hole Dia.
3-5/32" (80 mm)

- Measure the thickness of the wall from the inside edge to the outside edge and cut PVC pipe at a slight angle 1/4" (6 mm) shorter than the thickness of the wall. (Fig. 11)
- Place the plastic cover over the end of the pipe (for indoor side only) and insert the pipe in the wall. (Fig. 12)

3-3. Install the Rear Panel on the Wall

Be sure to confirm that the wall is strong enough to suspend the unit.

There are a number of screw holes on the rear panel. Using the 8 screw holes with ⇌ mark is recommended to attach the rear panel securely to the wall.

See either Item a) or b) below depending on the wall type.

a) If Wooden Wall

- Attach the rear panel to the wall with the 8 screws provided. (Fig. 13)

If you are not able to line up the holes in the rear panel with the beam locations marked on the wall, use rawl plugs or toggle bolts to go through the holes on the panel or drill 3/16" (5 mm) dia. holes in the panel over the stud locations and then mount the rear panel.

- Double check with a carpenter's level or tape measure that the panel is level. This is important to install the unit properly. (Fig. 14)
- Make sure the panel is flush against the wall. Any space between the wall and unit will cause noise and vibration.

b) If Block, Brick, Concrete or Similar Type Wall

Make 3/16" (4.8 mm) dia. holes in the wall. Insert rawl plugs for appropriate mounting screws. (Fig. 15)

NOTE

Hole should be made at a slight downward slant to the outdoor side.

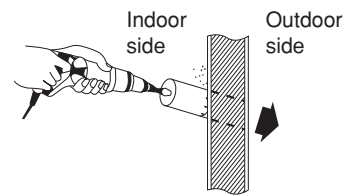
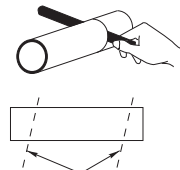

Fig. 10

PVC pipe (Locally purchased)



Cut at slight angle

Fig. 11

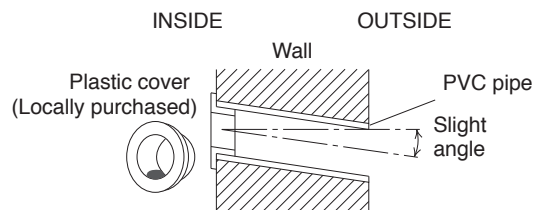

Fig. 12

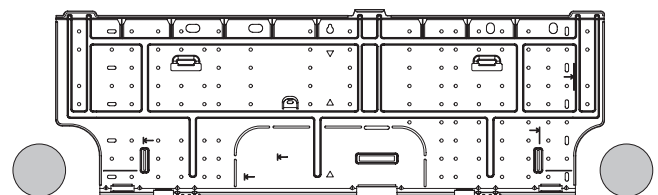

Fig. 13

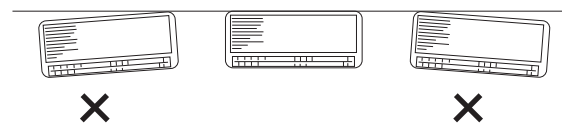

Fig. 14

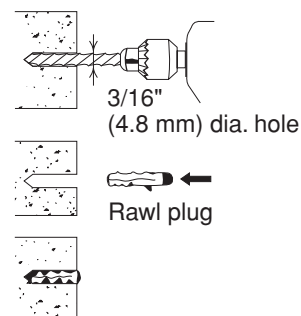

Fig. 15

3-4. Removing and Installing the Grille

Basically, these models can be installed and wired without removing the grille. If access to any internal part is needed, follow the steps as given below.

How to remove the grille

- (1) Open the front panel until it is nearly horizontal, grasp the sections near the front panel arms on both sides, and then remove the panel by pushing the arms towards the outside while pulling the panel towards you.
- If the front panel is difficult to remove, grasp both ends of it and lift it up slightly. Move it to the left and disengage the left arm, then move it to the right and disengage the right arm. (Fig. 16)
- (2) Lift the anti-mold filter up slightly to disengage it from the protrusions on the unit, and then pull downward to remove the filter from the unit. (Fig. 16)
- (3) Remove the 3 screws from the front of the unit and remove the screw covers on the bottom surface. Then remove the 2 screws. (Fig. 17)
- (4) Remove the screw on the right side cover plate and remove the cover. (Fig. 17a)
- (5) Remove the lower flap by disengaging 4 pins of the lower flap in order. (Figs. 17b and 17c)
(The flap is so flexible that it can be easily removed.)
- (6) Lift up the grille in the direction shown by the arrow and pull the grille towards you to remove it. (Fig. 17d)

How to replace the grille

- (1) While aligning the top edge of the grille with the frame, move the grille horizontally and insert the top and bottom into the frame.
- (2) Press the grille firmly with your hand to ensure no gap exists between the frame and grille.
- (3) Tighten the 6 screws. And fix the removed covers in place.
- (4) Grasp the sections near the front panel arms on both sides, and hold the front panel so that it is nearly horizontal. Push the arm shafts towards the outside so that they come into contact with the top of the indentations on the right and left sides of the air conditioner. Then push firmly until the arm shafts click into place. (Fig. 18)
- (5) Remount the lower flap.
(In remounting the flap, it cannot be turned end for end because the right and left pins of the flap differ in form. (Fig. 17c))
- (6) Insert the top of the anti-mold filter, and then secure the bottom of the filter with the protrusions on the unit.
- (7) When closing the front panel, push the central part of the front panel first and then press the bottom right and left corners in place until you feel a click. (Fig. 19)

NOTE

Check that no gap exists between the frame and the grille.

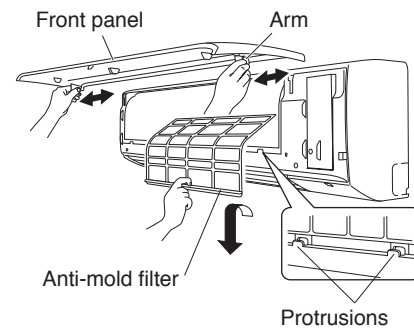

Fig. 16

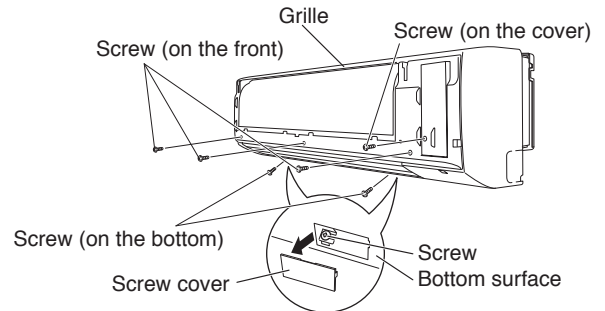

Fig. 17a

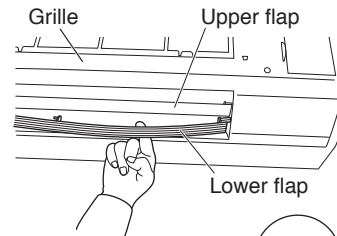

Fig. 17b

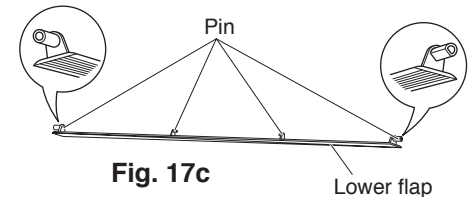

Fig. 17c

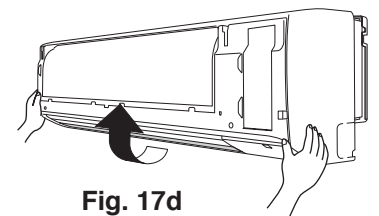

Fig. 17d

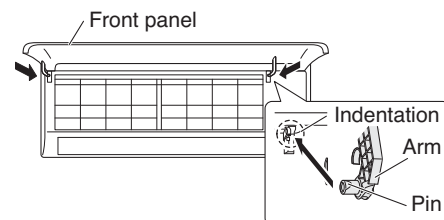

Fig. 18

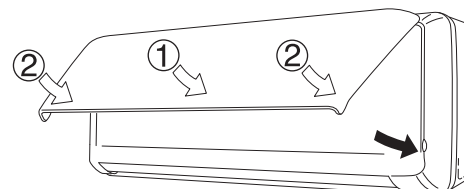

Fig. 19

3-5. Shape the Indoor Side Tubing

(1) Arrangement of tubing by direction

a) Right or left tubing

Cut out the corner of the right/left frame with a hacksaw or the like. (Figs. 20 and 21)

b) Right-rear or left-rear tubing

In this case, the corner of the frame need not be cut.

(2) To mount the indoor unit on the rear panel:

Hang the 3 mounting slots of the unit on the upper tabs of the rear panel. (Fig. 22)

3-6. Wiring Instructions

General precautions on wiring

- (1) Before wiring, confirm the rated voltage of the unit as shown on its nameplate, then carry out the wiring closely following the wiring diagram.
- (2) Provide a power outlet to be used exclusively for each unit, with a power supply disconnect and circuit breaker for overcurrent protection provided in the exclusive line.
- (3) To prevent possible hazards due to insulation failure, the unit must be grounded.
- (4) Each wiring connection must be done tightly and in accordance with the wiring system diagram. Wrong wiring may cause the unit to misoperate or become damaged.
- (5) Do not allow wiring to touch the refrigerant tubing, compressor, or any moving parts of the fan.
- (6) Unauthorized changes in the internal wiring can be very dangerous. The manufacturer will accept no responsibility for any damage or misoperation that occurs as a result of such unauthorized changes.

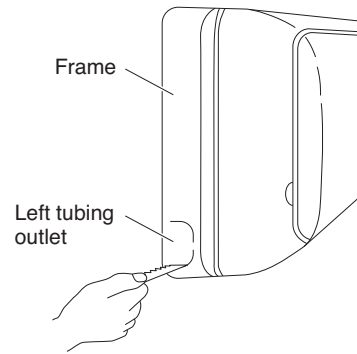

Fig. 20

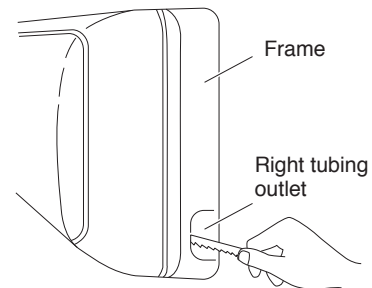

Fig. 21

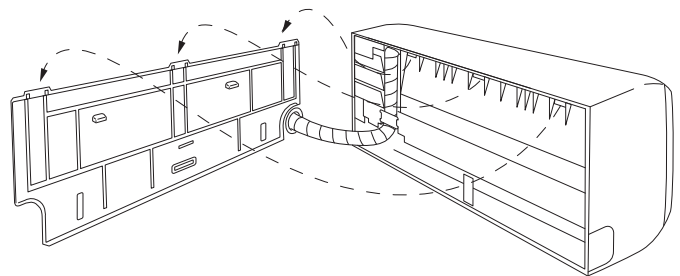

Fig. 22

3-7. Wire Size and Length

Regulations on wiring diameter differ from locality to locality. For field wiring requirements, please refer to your local electrical codes. Carefully observe these regulations when carrying out the installation.

NOTE

Refer to the wiring system diagram (Fig. 23) for the meaning of (A), (B), and (C) in Table 5.

Refer to your local codes or in the absence of local codes see the National Electric Code: ANSI/NFPA70.

Table 5

Model		(A) POWER SUPPLY WIRING	(B) POWER LINE	(C) CONTROL LINE
CU-KE30NKU CU-KE36NKU	Wire Size	AWG12 (min.) or bigger (*1) for CU-KE30NKU AWG10 (min.) or bigger (*1) for CU-KE36NKU	AWG14 or bigger	AWG14 or bigger
	Length	It depends on wire specification and supply voltage level (*2)	180 ft. (max.)	180 ft. (max.)
	Fuse or Circuit Breaker Capacity	35A for CU-KE30NKU 45A for CU-KE36NKU	Disconnect switch (15A)	-

(AWG: American Wire Gauge)

(*1) It depends on supply voltage level and wire specification. Consider temperature rating of wire, ambient temperature, and the number of wires inside the conduit.

(*2) Requirement of supply voltage level: AC187V to 253V (Measure voltage level at terminal plate inside the outdoor unit.)



WARNING

- Be sure to comply with local codes on running the wire from the indoor unit to the outdoor unit (size of wire and wiring method, etc.).
- Each wire must be firmly connected.
- No wire should be allowed to touch refrigerant tubing, the compressor, or any moving part.



WARNING

- To avoid the risk of electric shock, each air conditioner unit must be grounded.
- For the installation of a grounding device, please observe local electrical codes.
- Grounding is necessary, especially for units using inverter circuits, in order to release charged electricity and electrical noise caused by high tension. Otherwise, electrical shock may occur.
- Place a dedicated ground more than 7' (2 m) away from other grounds and do not have it shared with other electric appliances.



CAUTION

- Be sure to connect the power supply line to the outdoor unit as shown in the wiring diagram. The indoor unit draws its power from the outdoor unit.
- Do not run wiring for antenna, signal, or power lines of television, radio, stereo, telephone, security system, or intercom any closer than 3'4" (1 m) from the power cable and wires between the indoor and outdoor units. Electrical noise may affect the operation.

WIRING SYSTEM DIAGRAM

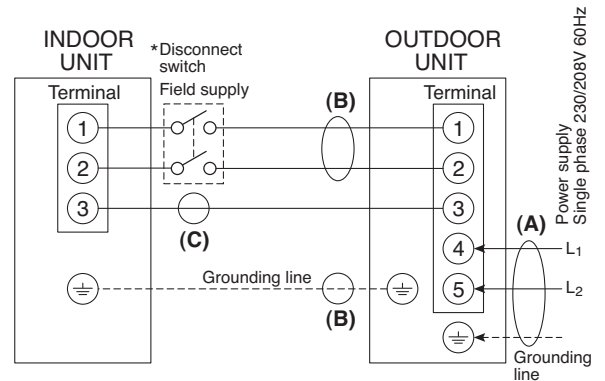

Fig. 23

* NOTE

Disconnect switch may be required by national or local codes.



CAUTION

Always comply with national and local code requirements.

3-8. Wiring Instructions for Inter-unit Connections

- (1) Insert the inter-unit wiring (according to local codes) into the through-the-wall PVC pipe. Run the wiring toward the indoor side allowing approx. 10" (25 cm) to extend from the wall face. (Fig. 24)
- (2) Grasp both ends of the front panel, push the arms towards the outside, and remove the front panel by opening it towards the front and pulling it towards you. If the front panel is difficult to remove, grasp both ends of it and lift it up slightly. Move it to the left and disengage the left arm, then move it to the right and disengage the right arm.
- (3) Remove the screw on the right side cover plate and open the cover. (Fig. 25)
- (4) Route the inter-unit wiring from the back of the indoor unit and pull it toward the front for connection. (Fig. 26a, 26b)
- (5) Connect the inter-unit wiring to the corresponding terminals on the terminal plate (Fig. 26a, 26b) while referring to the wiring diagram.
- (6) Be sure to secure the wiring with the provided clamp.

NOTE

When closing the front panel, push the central part of the front panel first and then press the bottom right and left corners in place until you feel a click. (Fig. 27)

Please refer to "How to replace the grille" on page 15 for installing the air intake grille.

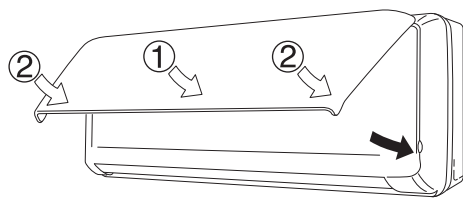

Fig. 27

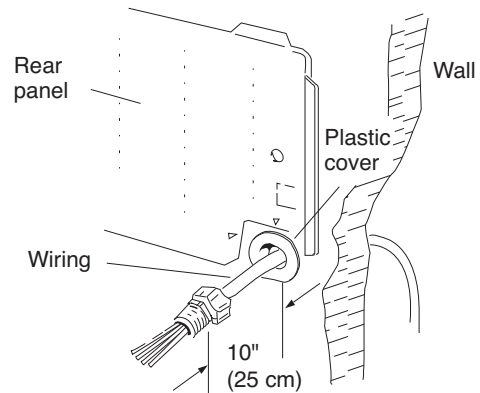

Fig. 24

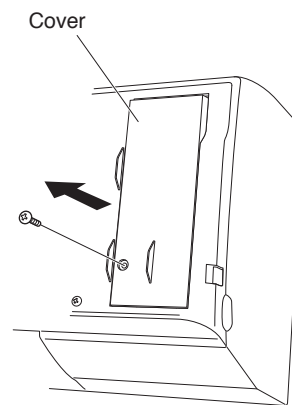

Fig. 25

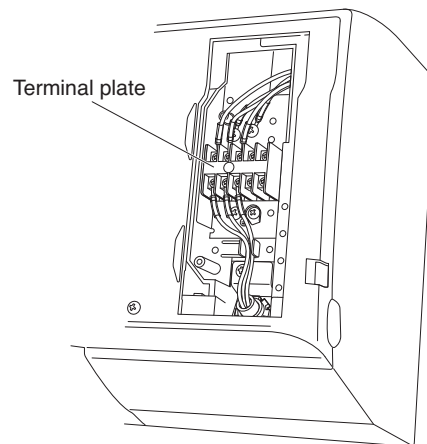

Fig. 26a

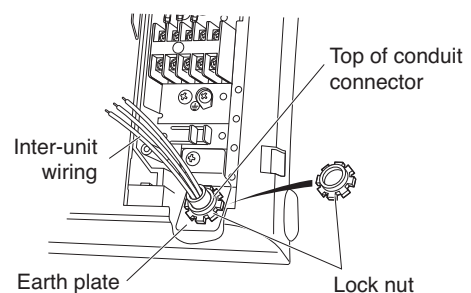

Fig. 26b

**WARNING**

Loose wiring may cause the terminal to overheat or result in unit malfunction. A fire hazard may also exist. Therefore, be sure all wiring is tightly connected.

When connecting each power wire to the corresponding terminal, follow the instructions “How to connect wiring to the terminal” and fasten the wire securely tight with the fixing screw of the terminal plate.

How to connect wiring to the terminal**a) For Indoor Unit**

- (1) Cut the wire end with a cutting pliers, then strip the insulation to expose the wire about 9/32" (7 mm). See the label (Fig. 28) near the terminal plate.
- (2) Using a screwdriver, loosen the terminal screw on the terminal plate.
- (3) Insert the wire and tighten the terminal screw completely using a screwdriver.

b) For Outdoor Unit**■ For solid core wiring (or F-cable)**

- (1) Cut the wire end with a cutting pliers, then strip the insulation to expose the solid wire about 15/16" (25 mm). (Fig. 29)
- (2) Using a screwdriver, remove the terminal screw(s) on the terminal plate.
- (3) Using the pliers, bend the solid wire to form a loop suitable for the terminal screw.
- (4) Shape the loop wire properly, place it on the terminal plate and fix it securely with the removed terminal screw using a screwdriver.

■ For stranded wiring

- (1) Cut the wire end with a cutting pliers, then strip the insulation to expose the stranded wiring about 3/8" (10 mm) and tightly twist the wire ends. (Figs. 30 and 31)
- (2) Using a screwdriver, remove the terminal screw(s) on the terminal plate.
- (3) Using a ring connector fastener or pliers, securely clamp each stripped wire end with a ring connector. (Fig. 30)
- (4) Place the ring connector wire, and replace and tighten the removed terminal screw using a screwdriver. (Fig. 32)

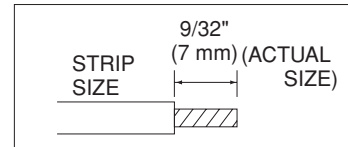
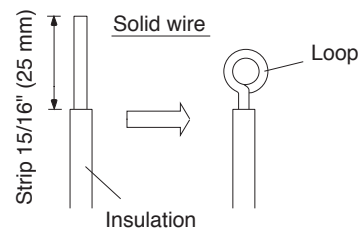
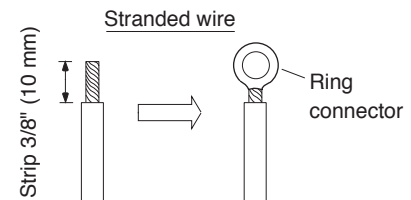
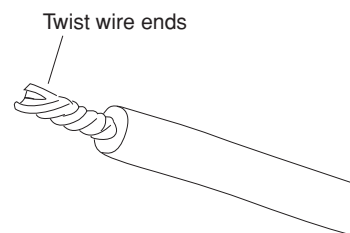
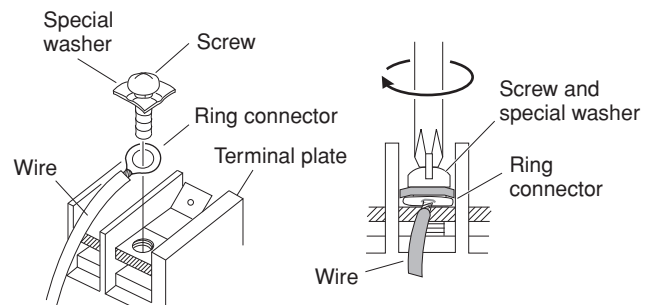
**Fig. 28****Fig. 29****Fig. 30****Fig. 31****Fig. 32**

3-9. Mounting

- (1) To install the indoor unit, mount the indoor unit onto the 3 tabs on the upper part of the rear plate.
- (2) Hold down the air discharge outlet and press the lower part of the indoor unit until it clicks to securely fasten to the 2 tabs on the lower part of the rear plate. (Fig. 33)

NOTE

For tubing, choose either the right or left tubing direction and follow the steps below. Also, extend the support on the back of the indoor unit as a stand to make your work easier. (Fig. 34)

■ Right-side tubing

- (1) Shape the refrigerant tubing so that it can easily go into the wall hole. (Fig. 35)
- (2) Push the wiring, refrigerant tubing, and drain hose through the hole in the wall. Adjust the indoor unit so it is securely seated on the rear panel. (Fig. 36)
- (3) Carefully bend the tubing (if necessary) to run along the wall in the direction of the outdoor unit and then tape as far as the fittings. (See Caution on page 25.) The drain hose should come straight down the wall to a point where water runoff won't stain the wall.
- (4) Connect the refrigerant tubing to the outdoor unit. (After performing a leak test on the connecting part, insulate it with the tubing insulation. (Fig. 37a)) Also, refer to Section 5-4. Connecting Tubing between Indoor and Outdoor Units.
- (5) Assemble the refrigerant tubing, drain hose, and conduit (including inter-unit wiring) as shown in Fig. 37b.

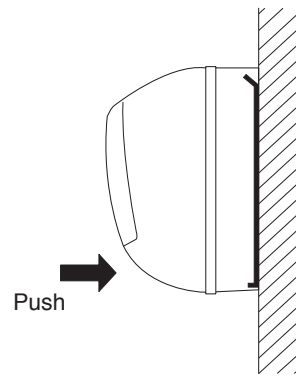

Fig. 33

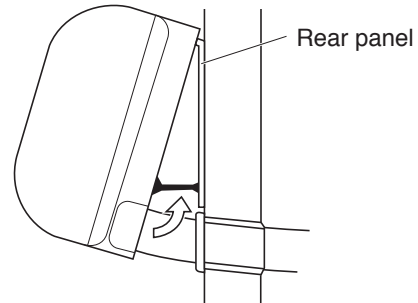

Fig. 34

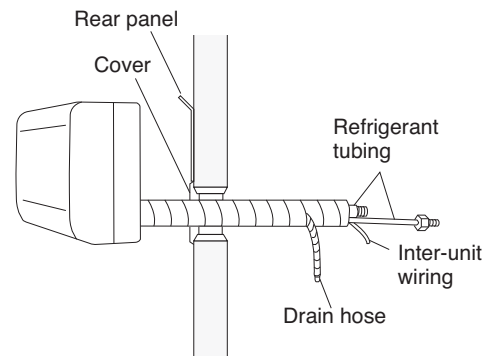

Fig. 35

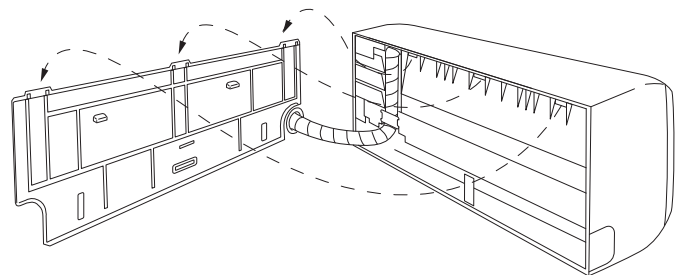

Fig. 36

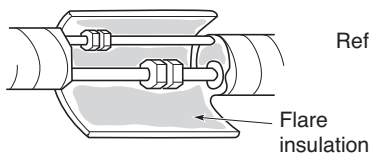

Fig. 37a

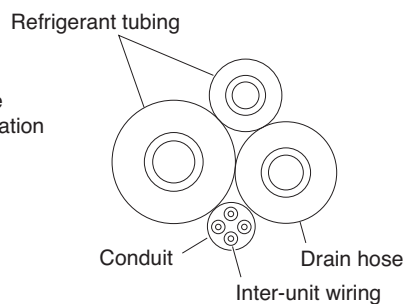

Fig. 37b

■ Left-side tubing

- (1) Lead the tubing and drain hose through the wall, allowing sufficient length for connection. Then bend the tubing using a tube bender to make the attachment. (Fig. 38)
- (2) Switch the drain hose and drain cap.

Switching drain hose and drain cap

- (a) Locate the drain hose and the drain cap. (Fig. 39)
- (b) Remove the screw fastening the drain hose on the right side, and pull out the drain hose to remove it. (Fig. 39)
- (c) Apply moderate force to pull off the drain cap on the left side. (If you cannot pull it off by hand, use a long-nose pliers.)
- (d) Reattach the drain hose to the left side and the drain cap to the right side. (Fig. 40a)

Drain hose

Slide the drain hose fully onto the drain pan outlet. (It will be easy to slide when water is added.) Check that the screw holes in the drain bracket and the drain pan outlet are aligned and securely in contact, then fasten them with the screw. (After attaching the drain hose, check that it is attached securely.) (Fig. 40b)

Drain cap

Use a Phillips screwdriver to push the drain cap in firmly. (If it is difficult to push in, wet the cap with water first.)

- (3) Install the indoor unit on the rear panel.
- (4) Connect the tubing and wiring led inside from outdoors.
- (5) After completing a leak test, bundle the tubing together with armoring tape and store it inside the tubing storage area at the back of the indoor unit and hold it with clamps. (Figs. 40a and 41)

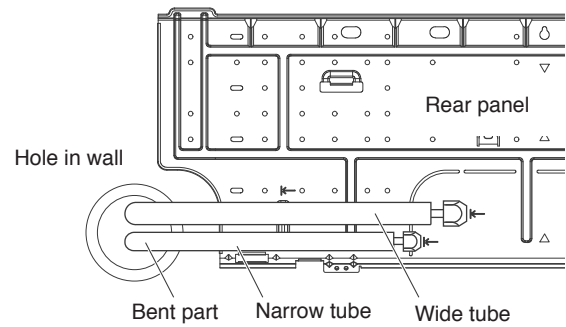

Fig. 38

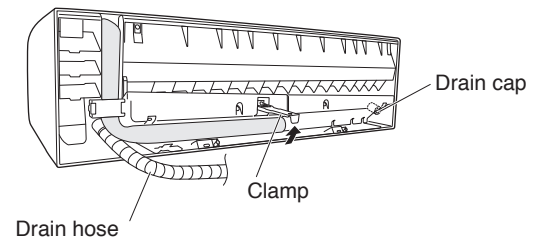

Fig. 39

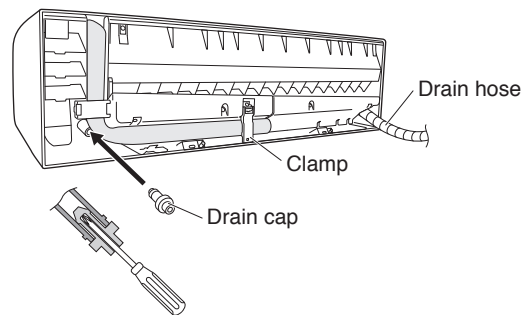

Fig. 40a

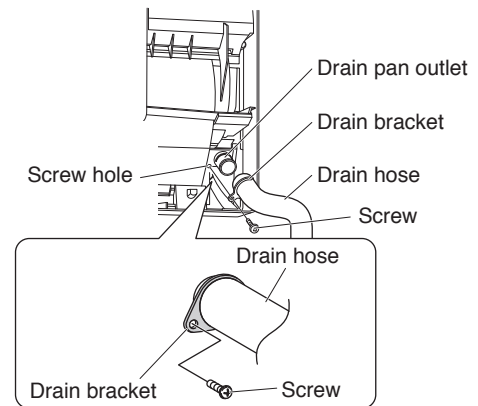

Fig. 40b

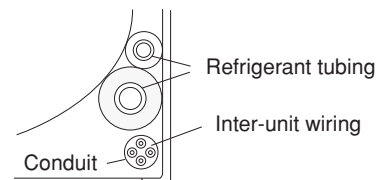

Fig. 41

To unmount indoor unit

Press the 2 \triangle marks on the lower part of the indoor unit and unlatch the tabs. Then lift the indoor unit and unmount. (Fig. 42)

3-10. Frame Fastening Method

- (1) Remove the screw cover on the bottom surface. (Fig. 43)
- (2) Fasten the frame to the rear panel using the 2 supplied tapping screws $5/32" \times 13/32"$ ($4 \times 10 \text{ mm}$). (Fig. 43)

NOTE

Under normal conditions, the installation design calls for a less than $3/32"$ (2 mm) gap between the air conditioner unit and the wall.

Confirm that the gap is appropriate (less than 2 mm).

3-11. Drain Hose

- a) The drain hose should be slanted downward to the outdoors. (Fig. 44)
- b) Never form a trap in the course of the hose.
- c) If the drain hose will run in the room, insulate the hose with insulation* so that chilled condensation will not damage furniture or floors. (Fig. 45)

* Foamed polyethylene or its equivalent is recommended.

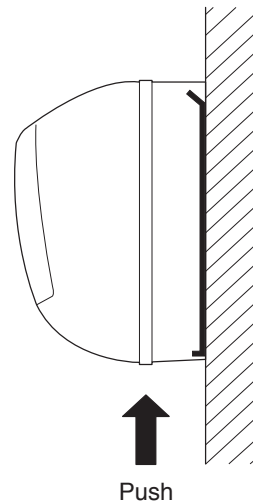

Fig. 42

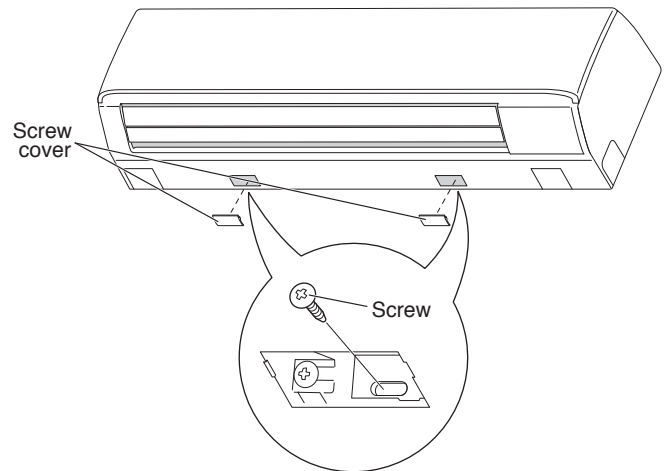

Fig. 43

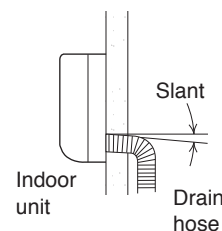

Fig. 44

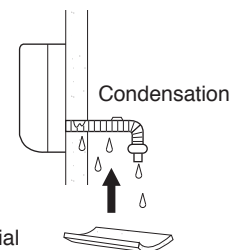

Fig. 45



WARNING

Do not supply power to the unit or operate it until all tubing and wiring to the outside unit are completed.



Risk of Electric Shock

4. How to Install the Outdoor Unit

First refer to Section 2. Installation Site Selection.

4-1. Wiring Instructions for the Outdoor Unit

Regulations on wire size differ from locality to locality. For field wiring requirements, please refer to your local electrical codes. Make sure that the installation fully complies with all local and national regulations.

- (1) Remove the 3 screws from the inspection panel.
(Fig. 46a)
Remove the inspection panel by sliding it downward and pulling it toward you. (Fig. 46b)
- (2) Connect the inter-unit and power supply line according to the wiring system diagram on the inspection panel. (Fig. 46c)
- (3) When connections are completed, check that all connections are correct as shown in the wiring system diagram.
- (4) Be sure to ground the unit according to your local codes.

4-2. Routing the Tubing and Wiring

- The tubing and wiring can be extended out in 3 directions: front, rear, and right. Use a nipper or similar tool to cut out the knockout holes for the inter-unit control wiring outlet, power wiring outlet, and tubing outlet from the appropriate covers A and B. (Fig. 46d)



- Route the tubing so that it does not contact the compressor, panel, or other parts inside the unit. Increased noise will result if the tubing contacts these parts.
- When routing the tubing, use a tube bender to bend the tubes.

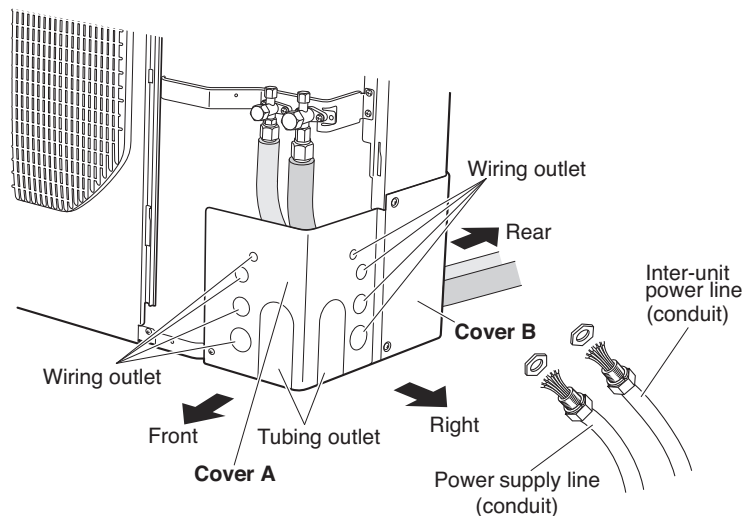
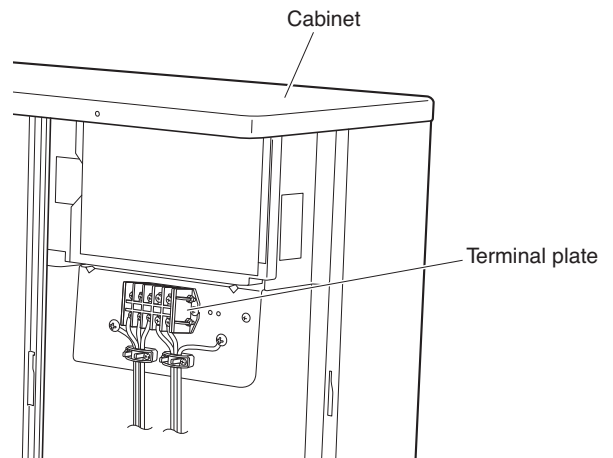
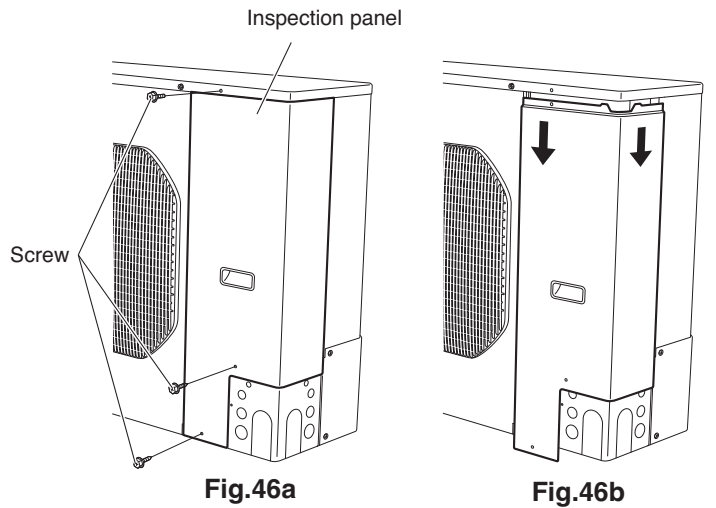

5. Refrigerant Tubing

5-1. Use of the Flaring Method

Many of the conventional split system air conditioners employ the flaring method to connect refrigerant tubes which run between indoor and outdoor units. In this method, the copper tubes are flared at each end and connected with flare nuts.

5-2. Flaring Procedure with a Flare Tool

- (1) Cut the copper tube to the required length with a tube cutter. It is recommended to cut approx. 12" to 20" (30 to 50 cm) longer than the tubing length you estimate.
- (2) Remove burrs at the end of the copper tube with a tube reamer or file. This process is important and should be done carefully to make a good flare. (Fig. 47)

NOTE

When reaming, hold the tube end downward and be sure that no copper scraps fall into the tube. (Fig. 48)

- (3) Remove the flare nut from the unit and be sure to mount it on the copper tube.
- (4) Make a flare at the end of copper tube with a flare tool.* (Figs. 49a and 49b)

(*Use "RIDGID" or equivalent.)

NOTE

A good flare should have the following characteristics:

- inside surface is glossy and smooth.
- edge is smooth.
- tapered sides are of uniform length.

5-3. Caution before Connecting Tubes Tightly

- a) Be sure to apply a sealing cap or water-proof tape to prevent dust or water from getting into the tubes before they are used.
- b) Be sure to apply refrigerant lubricant to the matching surfaces of the flare and union before connecting them together. This is effective for reducing gas leaks. (Fig. 50)
- c) For proper connection, align the union tube and flare tube straight with each other, then screw in the flare nut lightly at first to obtain a smooth match. (Fig. 51)

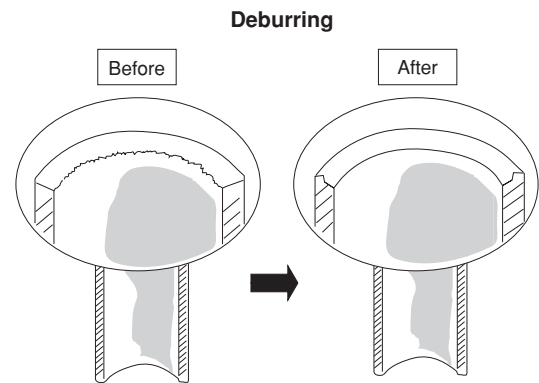

Fig. 47

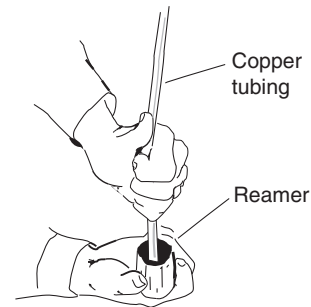
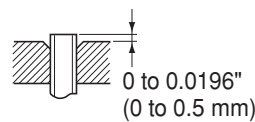
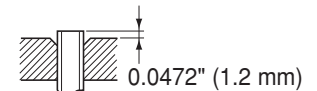

Fig. 48

If the special R410A flare tool is used:



If the previous flare tool (clutch-type) is used:



Adjust so that the amount of tube protrusion is as shown in the figure.

Fig. 49a

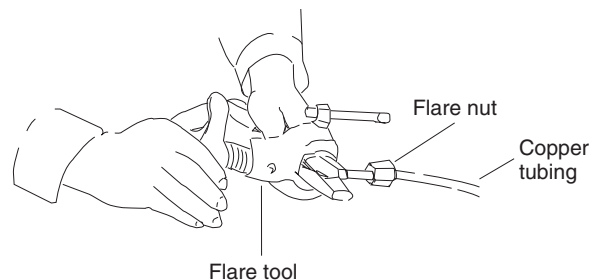

Fig. 49b

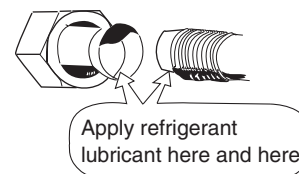

Fig. 50

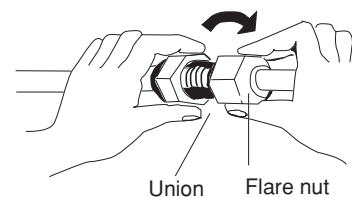

Fig. 51

5-4. Connecting Tubing between Indoor and Outdoor Units

- Tightly connect the indoor side refrigerant tubing extended from the wall with the outdoor side tubing. (Fig. 52)
- To fasten the flare nuts, apply specified torque as:

Table 6

Tube Dia.	Nut	Tightening Torque
1/4" (6.35 mm)	21/32" (17 mm)	Approx. 120 – 160 lbs·in (140 – 180 kgf·cm)
3/8" (9.52 mm)	7/8" (22 mm)	Approx. 300 – 360 lbs·in (340 – 420 kgf·cm)
1/2" (12.70 mm)	1-1/32" (26 mm)	Approx. 430 – 480 lbs·in (490 – 550 kgf·cm)
5/8" (15.88 mm)	1-5/32" (29 mm)	Approx. 590 – 710 lbs·in (680 – 820 kgf·cm)

5-5. Insulation of Refrigerant Tubing

IMPORTANT

To prevent heat loss and wet floors due to dripping of condensation, **both tubes must be well insulated with a proper insulation material.** (Fig. 53)

The thickness of the insulation should be a minimum 5/16" (8 mm). (Fig. 54)

5-6. Taping the Tubes



CAUTION

After a tube has been insulated, never try to bend it into a narrow curve, as this may cause the tube to break or crack.

- At this time, the 2 refrigerant tubes (and electrical wire if local codes permit) should be taped together with armoring tape. The drain hose may also be included and taped together as 1 bundle with the tubing.
- Wrap the armoring tape from the bottom of the outdoor unit to the top of the tubing where it enters the wall. As you wrap the tubing, overlap half of each previous tape turn. (Fig. 55)
- Clamp the tubing bundle to wall, using 1 clamp approx. every 47" (120 cm).

NOTE

Do not wind the armoring tape too tightly, since this will decrease the heat insulation effect. Also, be sure the condensation drain hose splits away from the bundle and drips clear of the unit and the tubing.

5-7. Finishing the Installation

After finishing insulating and taping over the tubing, use sealing putty to seal off the hole in the wall to prevent rain and draft from entering. (Fig. 56)

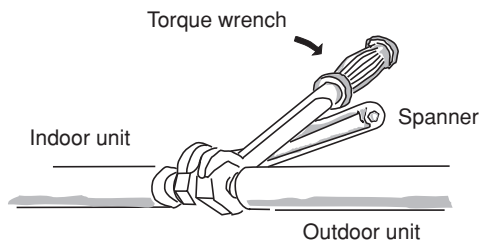

Fig. 52

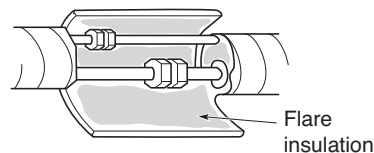

Fig. 53

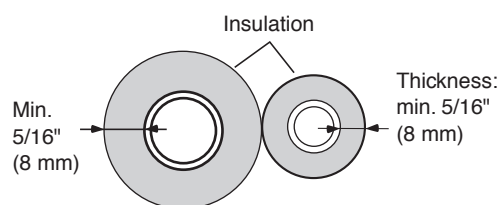

Fig. 54

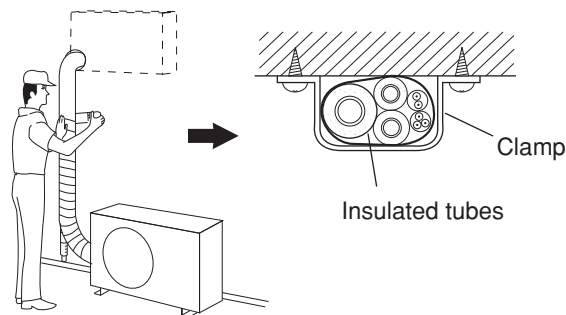

Fig. 55

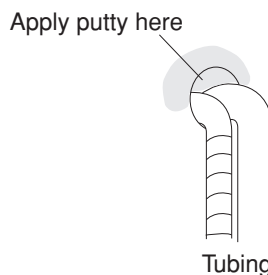

Fig. 56

6. Air Purging

Air and moisture remaining in the refrigerant system have undesirable effects as indicated below. Therefore, they must be purged completely.

- pressure in the system rises
- operating current rises
- cooling (or heating) efficiency drops
- moisture in the air may freeze and block capillary tubing
- water may lead to corrosion of parts in the refrigerant system

■ Air Purging with a Vacuum Pump (for Test Run)

- (1) Check that each tube (both narrow and wide tubes) between the indoor and outdoor units have been properly connected and all wiring for the test run has been completed. Note that both narrow and wide tube service valves on the outdoor unit are kept closed at this stage.
- (2) Using an adjustable wrench or box wrench, remove the valve caps from the service valve on both narrow and wide tubes.
- (3) Connect a vacuum pump and a manifold valve (with pressure gauges) to the service port on the wide tube service valve. (Fig. 57)



CAUTION

The service port on the wide tube service valve uses a Schrader core valve to access the refrigerant system. The valve core is similar to those used in automobile tires. Therefore, be sure to use a vacuum hose connector which has a push-pin inside.



CAUTION

Be sure to use a manifold valve for air purging. If it is not available, use a stop valve (field supply) for this purpose. The “Hi” knob of the manifold valve must always be kept closed.

- (4) With the “Lo” knob of the manifold valve open, run the vacuum pump. The operation time for the vacuum pump varies with tubing length and the capacity of the pump. The following table shows the amount of time for evacuation:

Table 7

Required time for evacuation when 100 liter/h vacuum pump is used	
If tubing length is less than 33 ft. (10 m)	If tubing length is more than 33 ft. (10 m)
10 min. or more	15 min. or more

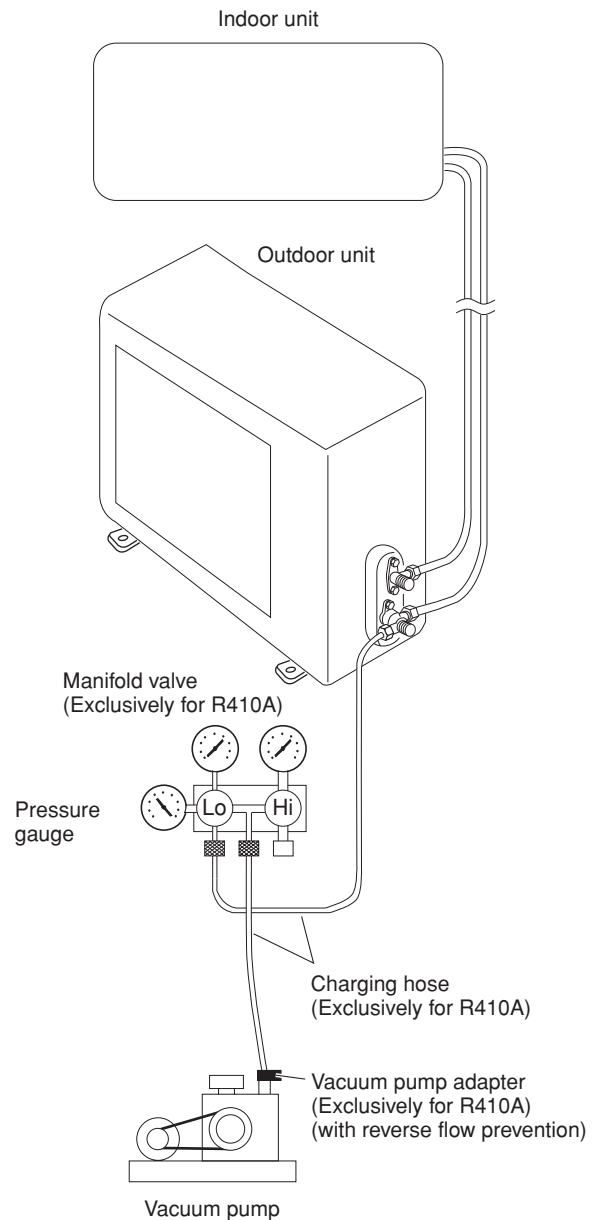

Fig. 57

NOTE

To prevent other refrigerants from being mistakenly charged to units which use R410A, the size of the charge port on the service valve is different from the one for other refrigerant types. For servicing such as recharging, the specified charging hose, manifold and vacuum pump adapter (with reverse flow prevention) for R410A must be used.

NOTE

The required time in Table 7 is calculated based on the assumption that the ideal (or target) vacuum condition is around 10 mmHg abs.

- (5) With the vacuum pump still running, close the “Lo” knob of the manifold valve. Then stop the vacuum pump.
- (6) With the hex wrench, turn the valve stem on the narrow tube service valve counter-clockwise by 90 degrees (1/4 turn) for 10 seconds, and then turn the stem clockwise to close it again. (Fig. 58)



CAUTION

Be sure to completely insert the hex wrench before attempting to turn the valve.

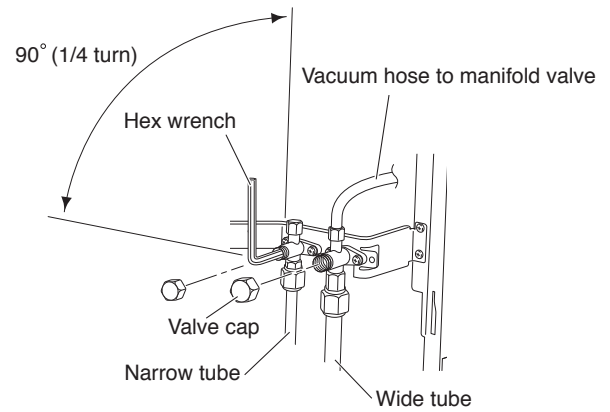

Fig. 58

- (7) Leak test all joints at the tubing (both indoor and outdoors) with soapy water. Bubbles indicate a leak. Tighten the joint more when leaks, then check if there is no leak. Be sure to wipe off the soap with a clean cloth.
- (8) With the hex wrench, turn the wide tube service valve stem counter-clockwise to fully open the valve.
- (9) Turn the narrow tube service valve stem counter-clockwise to fully open the valve.
- (10) Loosen the vacuum hose connected to the wide tube service port slightly to release the pressure. Then, remove the hose.



CAUTION

This may cause the refrigerant gas to leak. In order to avoid this, take off the hose quickly.

- (11) Fasten the valve cap on the wide tube service port securely with an adjustable wrench or box wrench. Next, mount the valve cap on the service valve and tighten it to 170 lbs-in (200 kgf·cm) with a torque wrench. This process is very important to prevent gas from leaking from the system.
- (12) Test run the air conditioner. (See next page.)
- (13) While the air conditioner is running, apply liquid soap to check for any gas leaks around the service valves or caps.
- (14) If there is no leakage, stop the air conditioner.
- (15) Wipe off the soap on the tubing.

This completes air purging with a vacuum pump and the air conditioner is ready for actual operation.

How to Test Run the Air Conditioner

After turning on the power of the air conditioner, use the remote controller and follow the steps below to conduct the test run.

- (1) Set the remote controller in Test Run mode. (Fig. 59a)
 - a) Press and hold the QUIET button and the 1HR. TIMER button.
 - b) Then press and hold the ACL (Reset) button with a pointed object such as the tip of a pen. After 5 seconds, release the ACL button first.
 - c) Then release the QUIET and 1HR. TIMER buttons.
 - d) ✻ appears and “oP-1” blinks in the remote controller clock display area. (Fig. 59b)
- (2) Start Cooling mode test run by pressing the ON/OFF operation button of the remote controller. (Fig. 59a)
 - This starts the fan producing uncooled forced air with the 3 indicator lamps (OPERATION lamp, TIMER lamp, and ●●) on the main unit blinking. (Fig. 59c)
 - After 3 minutes, the system shifts into cooling operation, and cool air will start to be felt. Cooling mode test run is unaffected by the room temperature.
- (3) Press the ON/OFF operation button of the remote controller again to stop the test run. (Fig. 59a)
- (4) Finally press the ACL (Reset) button of the remote controller to release it from Test Run mode to return to normal mode. (Fig. 59a)
 - “✻” and “oP-1” will disappear from the remote controller clock display area.

NOTE

Troubleshooting:

In the event that the green OPERATION lamp is blinking upon powering up the system, an error condition exists. In this case, refer to the self-diagnostics procedure on the inside of the front cover.

IMPORTANT

After the test run is completed, be sure to press the ACL (Reset) button to return to normal mode. The air conditioner will not operate correctly if this is not done.

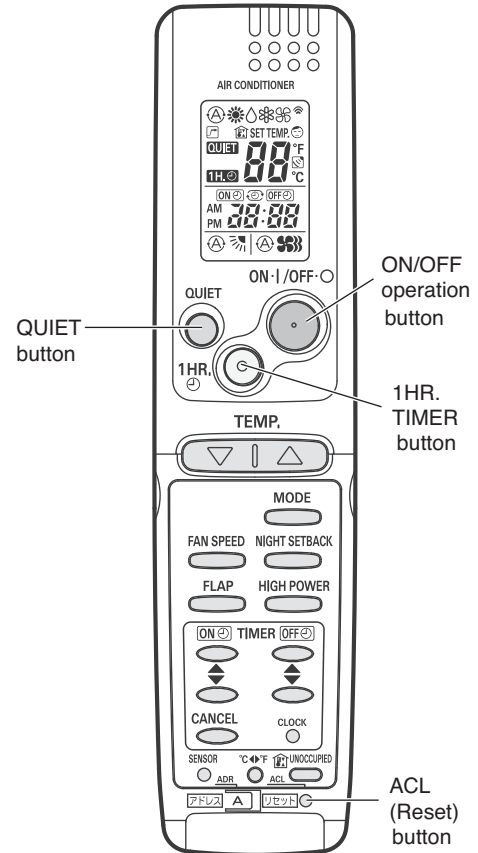

Fig. 59a

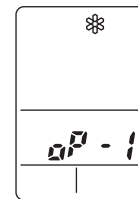

Fig. 59b

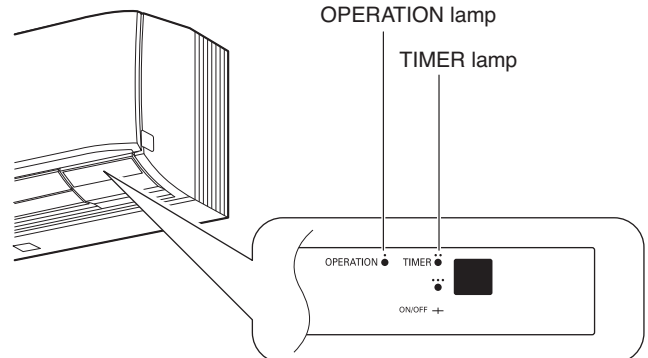
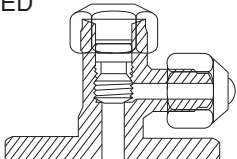
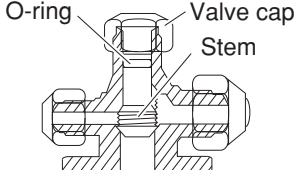
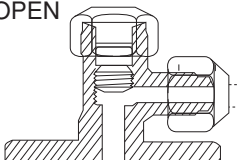
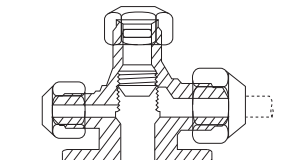
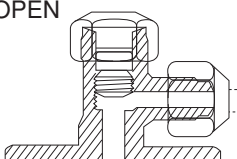
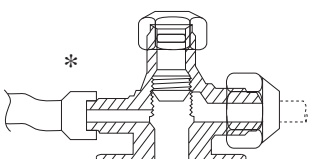
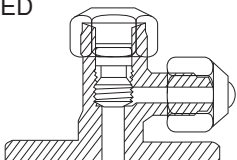
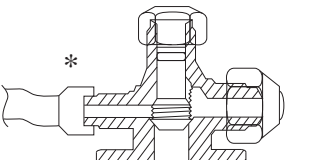

Fig. 59c

■ Basic Functions of the Service Valves

The basic functions of the service valves are given in Table 8 below.

Table 8

Action	Narrow Tube Service Valve (2-Way)	Wide Tube Service Valve (3-Way)
Shipping	CLOSED 	O-ring, Valve cap, Stem 
Operating and test running the air conditioner	Fully OPEN 	
Measuring pressure and gas charging	Fully OPEN 	* 
Air purging with a vacuum pump	CLOSED 	* 

* The service port on the wide tube service valve uses a Schrader core valve to access the refrigerant system. Therefore, be sure to use a hose connector which has a push-pin inside. (Fig. 60a)

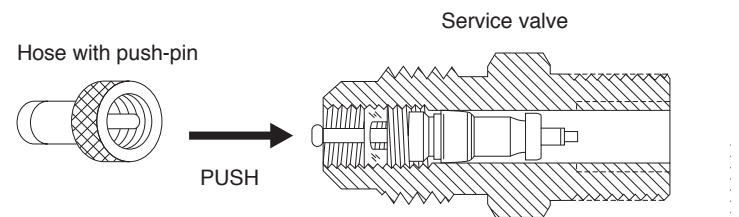
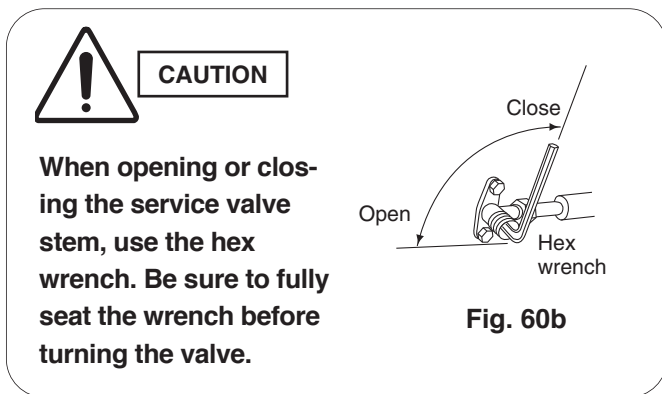

NOTE

External diameter of service port R410A: 5/16"

Fig. 60a

■ Pump Down

Pump down means collecting all refrigerant gas in the system back into the outdoor unit without losing any of the gas. Pump down is used when the unit is to be moved or before servicing the refrigerant circuit.

Pump Down Procedure

Be sure to carry out pump down with the unit in cooling mode.

(1) Connect the Lo side charging hose of the manifold valve to the service port on the wide tube service valve.

- (2) Using a hex wrench, turn the narrow tube service valve clockwise all the way to close the service valve. (Be sure to confirm that the wide tube service valve is fully open.)
- (3) Press the operation button and start cooling operation.
- (4) When the low pressure gauge reading falls to 14.2 to 7.1 psi (1 to 0.5 kg/cm²), fully close the wide tube valve stem. Then quickly stop the unit.
- (5) Disconnect all gauges and hoses, and replace the valve caps as they were before.

■ Service Valve Connections

- Temporary connection:
Screw in 3 – 5 turns by hand. (Fig. 60c)
- To fasten the flare nuts, apply specified torque as Table 9 and Fig. 60d.

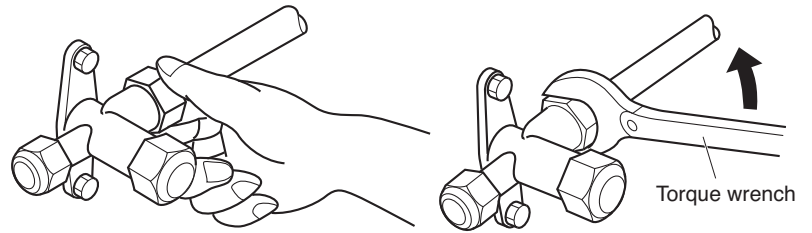

Table 9

Tube Dia.	Nut	Tightening Torque
1/4" (6.35 mm)	21/32" (17 mm)	Approx. 120 – 160 lbs·in (140 – 180 kgf·cm)
3/8" (9.52 mm)	7/8" (22 mm)	Approx. 300 – 360 lbs·in (340 – 420 kgf·cm)
1/2" (12.70 mm)	1-1/32" (26 mm)	Approx. 430 – 480 lbs·in (490 – 550 kgf·cm)
5/8" (15.88 mm)	1-5/32" (29 mm)	Approx. 590 – 710 lbs·in (680 – 820 kgf·cm)

Fig. 60c

Fig. 60d



CAUTION

Be sure to tighten the flare nut using the prescribed torque. If the nut is over-tightened, refrigerant leakage may occur.

7. Remote Controller Installation Position

The remote controller can be operated from either a non-fixed position or a wall-mounted position.

To ensure that the air conditioner operates correctly, do not install the remote controller in the following places:

- In direct sunlight
- Behind a curtain or other place where it is covered
- More than 26' (8 m) away from the air conditioner
- In the path of the air conditioner's airstream
- Where it may become extremely hot or cold
- Where it may be subject to electrical or magnetic interference
- Where there is an obstacle between the remote controller and the air conditioner (since a check signal is sent from the remote controller every 5 minutes)

7-1. Mounting on a Wall

Before mounting the remote controller, press the ON/OFF operation button at the mounting location to make sure that the air conditioner operates from that location. The indoor unit should make a beeping sound to indicate that it has received the signal.

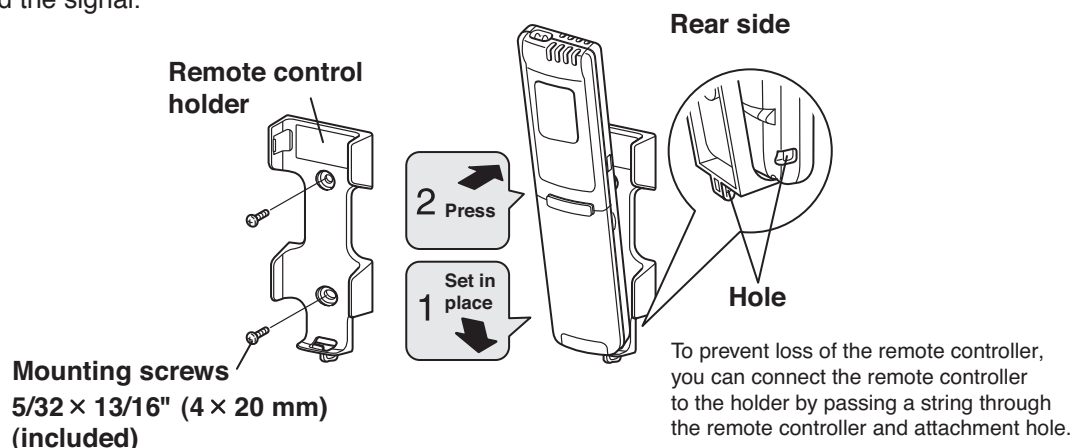

To take out the remote controller, pull it forward.

Fig. 61

8. Address Switch

8-1. Address Setting of the Remote Controller

The address can be set in order to prevent interference between remote controllers when 2 indoor units are installed near each other. The address is normally set to “A.” To set a different address, it is necessary to change the address on the second remote controller.

NOTE

Once changed, you cannot restore the original address setting of the air conditioner.

- (1) Switch on the power source.
- (2) Break the address-setting tab marked “A” on the second remote controller to change the address (Fig. 62). When the tab is removed, the address is automatically set to B (Fig. 63).
- (3) Press and hold the remote controller QUIET button and 1HR. TIMER button. Then press and hold the ACL (Reset) button with a pointed object such as the tip of a pen. After 5 seconds, release the ACL button first, then release the QUIET and 1HR. TIMER buttons. “oP-1” (Test Run) appears, blinking in the remote controller clock display area.
- (4) Each time the 1HR. TIMER button is pressed, the display changes as shown below. Press this button 3 times to change the display to “oP-7” (Address setting). (Fig. 64)

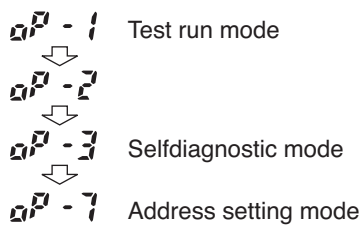

- (5) “oP-7” has now been selected for address setting.
- (6) Press the ON/OFF operation button on the remote controller. (Fig. 64) Check that the “beep” signal-received sound is heard from the second indoor unit (approximately 5 times). The sound you hear is the signal that the remote controller address has been changed.
- (7) Finally press the remote controller ACL (Reset) button to cancel the blinking “oP-7” display. (Fig. 64)

Changing of the second remote controller address is now completed.

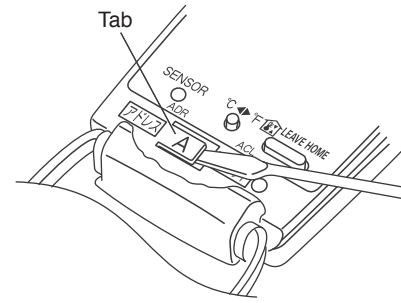

Fig. 62

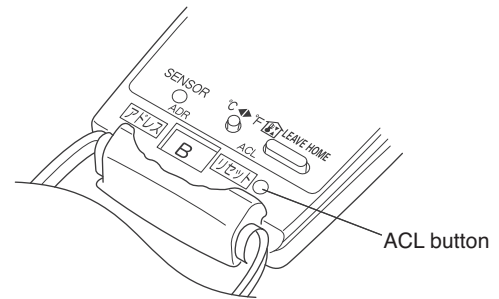

Fig. 63

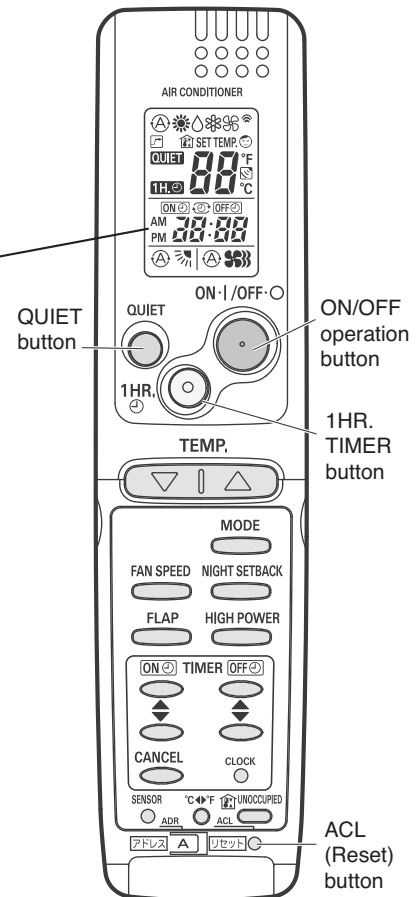

Fig. 64

