

ES1000

USER'S MANUAL

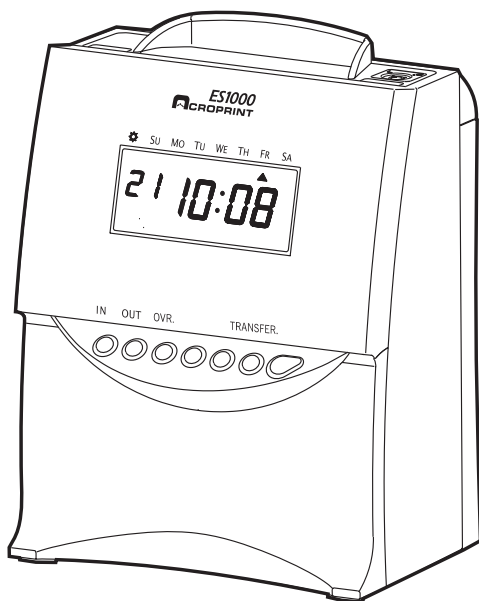

WARNING

This equipment has been tested and found to comply with the limits for a Class A digital device, pursuant to Part 15 of FCC Rules. These limits are designed to provide reasonable protection against harmful interference when the equipment is operated in a commercial environment. This equipment generates, uses, and can radiate radio frequency energy and, if not installed and used in accordance with the instruction manual, may cause harmful interference to radio communications. Operation of this equipment in a residential area is likely to cause harmful interference in which case the user will be required to correct the interference at his or her own expense.

Caution: Changes or modifications not expressly approved by the party responsible for compliance could void the user's authority to operate the equipment.

THIS DIGITAL APPARATUS DOES NOT EXCEED THE CLASS A LIMITS FOR RADIO NOISE EMISSIONS FROM DIGITAL APPARATUS AS SET OUT IN THE RADIO INTERFERENCE REGULATIONS OF THE CANADIAN DEPARTMENT OF COMMUNICATIONS.

LE PRÉSENT APPAREIL NUMÉRIQUE N'ÉMET PAS DE BRUITS RADIOÉLECTRIQUES DÉPASSANT LES LIMITES APPLICABLES AUX APPAREILS NUMÉRIQUES DE CLASSE A PRESCRITES DANS LE RÈGLEMENT SUR LE BROUILLAGE RADIOÉLECTRIQUE ÉDICTÉ PAR LE MINISTÈRE DES COMMUNICATIONS DU CANADA.



1. The details of this User's Manual are subject to change without previous notification.
2. This User's Manual has been prepared with the utmost care to cover all aspects of the time recorder's use.
If you feel, however, that some explanations are inadequate, unclear, or difficult to understand, please do not hesitate to contact Acroprint.
3. No part of this publication may be reproduced, stored in a retrieval system, or transmitted, in any form or by any means, mechanical, photocopying, recording or otherwise without the written consent of Acroprint Time Recorder.
 - Place the time recorder at the position close to the wall outlet so that it is easily accessible to disconnect.





Precautions







This user's manual is prepared for safe and proper use of the unit. Please follow all the instructions to avoid possible danger to yourself or others and damage to the unit.

Signs

Various warnings and cautions are provided throughout this manual along with signs. Remember each sign and its explanation listed below for your safety and proper operation of the unit.

 Warning	Improper handling may cause bodily accidents including death and serious injury.
 Caution	Improper handling may harm the human body or material.

 Improper handling may cause electric shock DANGER.	 "Must-Do" sign.
 DO NOT disassemble the unit.	 Be sure to remove the line cord plug from the outlet.
 "Don't" sign.	

 Warning	
	Do not disassemble the unit. There is a high voltage present inside, possibly leading to an electric shock.
	Do not modify the unit. Modifications may cause a fire and/or electric shock.
	If any anomaly occurs, for example, heat or smoke is generated or an odor is emitted, unplug the unit immediately and contact your dealer for servicing. There is a danger that further use may cause a fire or electric shock.
	Do not use any voltage of the power source other than designated. Do not share a single outlet with another plug. These may lead to fire or shock hazards.
	Do not damage, break, or modify the power cord. Do not put a heavy object on, pull, or forcefully bend the cord, either. These may damage the cord, possibly resulting in a fire or electric shock.



If foreign matter should get in the unit (including a piece of metal, water, or liquid), disconnect the plug from the outlet immediately and contact your dealer for servicing. There is a danger that further use may cause a fire or electric shock.



Do not plug or unplug the unit with a wet hand. You may get an electric shock.



Caution



Do not place the unit on an uneven or tilted surface. This may result in injuries due to the unit dropping or falling off.



Do not put a water-filled container or a metal object on top of the unit. If water is spilled or the metallic object slips inside, a fire or shock hazard may occur.



Do not install the unit in a humid or dusty environment. It may cause a fire or electric shock.



Do not place the unit near kitchen counter or humidifier. Oil, smoke, or steam generating from them may cause fire or shock hazards.



Do not yank the power cord to disconnect from the outlet. Hold the plug with your hand to do so, or the cord may be damaged, possibly leading to a fire or electric shock.



Remove the line cord plug from the outlet before transferring the unit, or it may damage the cord, possibly leading to a fire or electric shock.



Be careful not to contact the print head, as you may get hurt or burned.



Make sure to insert the power plug as far as it will go. Improper insertion of the plug may develop fire or shock hazards.



Do not insert or drop any other time card than specified into the slot. Such misuse may cause a fire or electric shock.



If the unit should be dropped or the case be broken, unplug the unit and contact your dealer for servicing. Further use may lead to a fire or shock hazard.

Table of Contents

1. Introduction and Features of the ES1000	1
2. Getting Started	2
Unpacking the ES1000	2
Overview	2
Installing the Ribbon Cassette	3
Wall Mounting the ES1000	5
Where to Install the ES1000	5
3. Overview of Operation	6
What You Can Do with the ES1000	7
4. Settings	11
Preparation for Setting	11
Overview of Function Buttons	12
Setting the Hour Display Format	13
Setting the Time	14
Setting the Date	15
Setting Pay Period and Pay Period Ending Date	16
Monthly	16
Weekly	17
Bi-Weekly	18
Semi-monthly	19
Setting the Day Advance Time	20
Selecting the Print Format	21
Enabling Override and Transfer Functions	22
Selecting Rounding Rules	23
Schedule (Setting Calculation Rules)	25
Setting the Schedule	26
Free Zone or Open Shift (easy and most popular)	26
Time Zone or Fixed Shift (ideal when everyone is on the same schedule)	30
Overtime Calculation	37
Round and Grace Time for Start/End Time (ST/ET)	42
Setting the Weekly Program for External Time Signal	45
Setting the Auto Daylight Saving Change	48
Selecting the Language	52
Setting the Password	53

5	Printing Hours Summary	57
6.	Printing List of Active Card Numbers	58
7.	Printing List of Program Settings	59
8.	Additional Features	60
	Override Printing	60
	Card Transfer	61
	Card Resetting	63
	All Cards Resetting	63
9.	Resetting	64
10.	Installing the Optional Battery Backup	65
11.	Connecting External Signal Control	66
12.	Troubleshooting	68
13.	Specifications	69

**For accessories, visit Acroprint on-line
at www.acroprint.com or
call 800.334.7190 or (919) 872.5800 (outside the USA)**

1. Introduction and Features of the ES1000

The ES1000 Totalizing Time Recorder provides fast, easy and accurate calculations of your employee hours worked. The ES1000 can handle a Weekly, a Bi-Weekly, a Semi-Monthly or a Monthly pay period for up to 100 employees. The recorder can be programmed to print late in or early out punches in "RED". This state-of-the-art totalizing recorder offers a program for an external signal (Bell/Horn, *not included*) and an optional full operational battery back up for punching without AC power.

The ES1000 allows for the selection of two sets of calculating rules:

Free Zone or "Open Shift" rules permits employees to punch IN and OUT without being assigned to a fixed schedule. Employee's times are calculated using elapsed time or punched IN time subtracted from punched OUT time. *Using this selection is the easiest and most popular form of totalizing employee's hours worked.*

Free Zone allows for Auto Lunch deduction and permits you to select the length of the break. You may also choose the number of regular hours worked before overtime is calculated. You may also select the maximum hours an employee is on the clock when it would be considered a "forgotten" out punch.

Using the Free Zone calculating rules will permit easy, accurate totalizing of your payroll hours.

Time Zone or Fixed Schedule rules are designed for companies that have all employees on one assigned shift. Time Zone rules allows for assignment of "start" and "stop" times of the shift with GRACE times with early or late punches printing in RED. Time Zone permits three break periods.

Time Zone rules may also be used with Free Zone rules under certain circumstances. Taking advantage of all these advance features will require additional programming time but will offer an advance time and attendance system.

2. Getting Started

Unpacking the ES1000

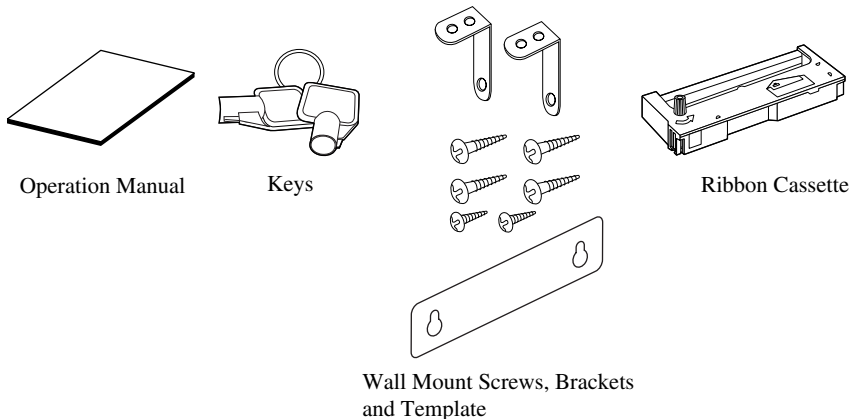

Overview

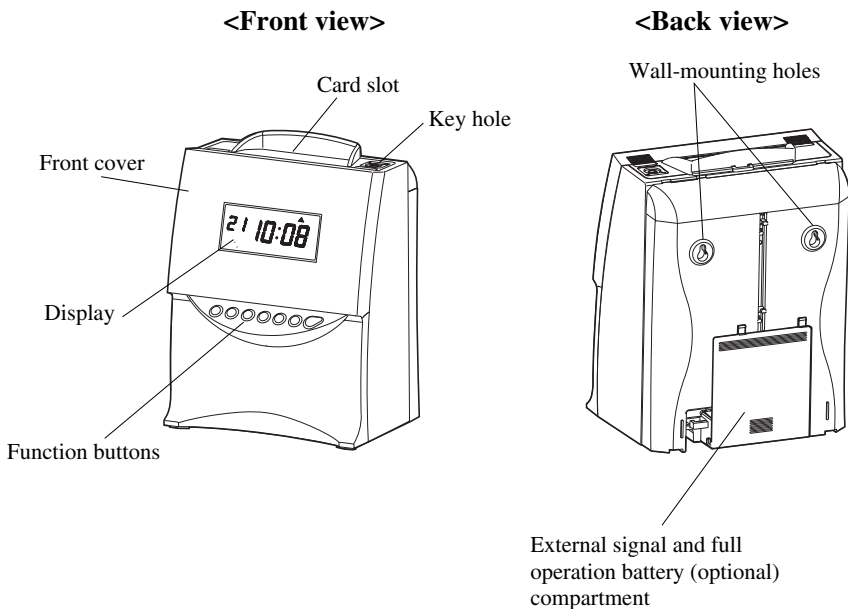

Installing the Ribbon Cassette

Make sure the power is on before installing.

- 1 Unlock cover and pull up the top side of the card insertion slot and pull it towards you.

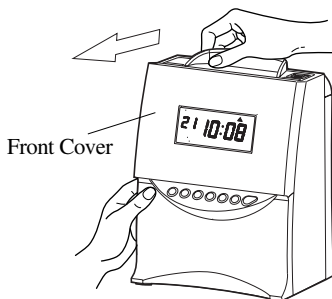

- 2 Turn the knob on the cassette in the arrow-indicated direction to make the ribbon taut.

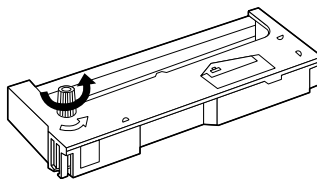

- 3 To insert the ribbon cassette inside the unit, thread the ribbon between the ribbon mask and the print head (See drawing next page). Slide the clasps on the lower side of the cassette into projections on the unit. Keep on pushing in the ribbon cassette until the clasps at both sides catch and the cassette snaps into position. If it is difficult to insert the ribbon cassette, try it while turning the knob.

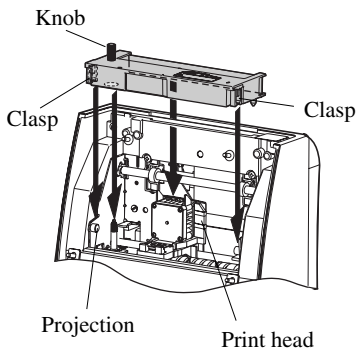

4 Precautions to take when replacing the ribbon

Take the following precautions when inserting a new ribbon cassette.

Install the ribbon cassette so that the ribbon is between the print head and the ribbon mask (see the figure on the left). Printing failure may occur if the ribbon is placed behind the ribbon mask (see the figure below).

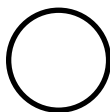
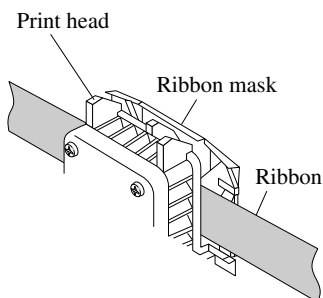

Correct

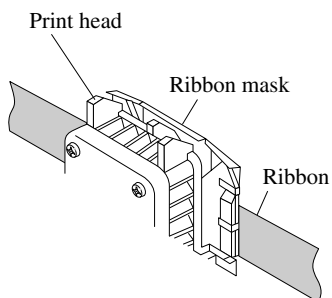

Incorrect

5 Turn the knob of the ribbon cassette in the counter clockwise to tighten the ribbon.

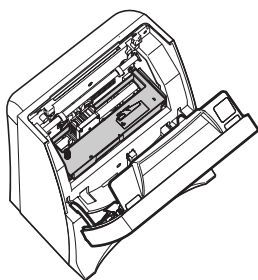

6 Replace the cover by fitting the tabs at the bottom of the cover into the holes located on the clock. Then close the cover letting it snap into place.

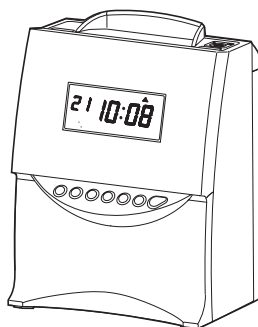

Wall Mounting the ES1000

The ES1000 may be platform or wall mounted using the wall mount screws supplied. To mount unit on wall, take the following steps:

- 1 Install wall mount screws (supplied) into a wall 3.94 inches (10 cm) apart. Be sure to keep about 0.12 inch (3 mm) of the screw head out of the wall. You can use a supplied template to fix position of two screws.



The supplied screws are intended for use on a thick wooden wall or wooden column. Do not use them on any other materials. There is a danger that the unit may come off if used on other materials.

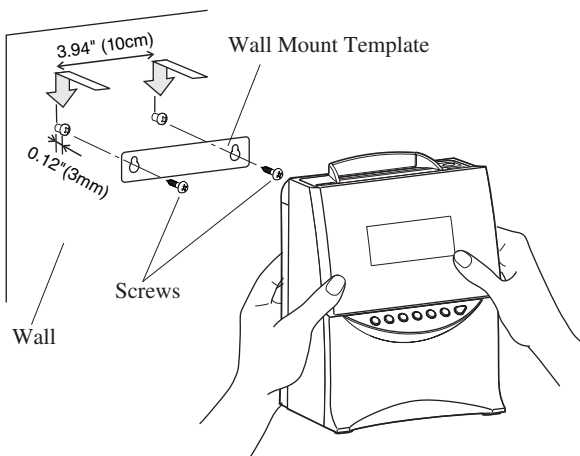

- 2 Mount the wall mount brackets as shown on the right.

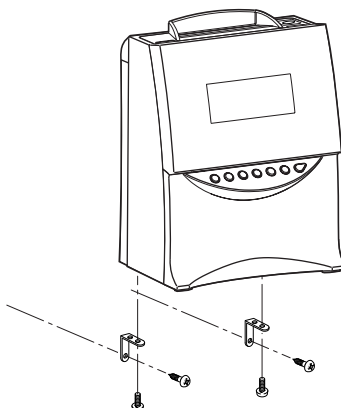

Where to Install the ES1000

Avoid placing the unit in environments that are:

- humid or dusty
- exposed to direct sunshine
- subject to frequent or continuous vibrations
- outside the temperature range between -5° and 45° C (23° to 113° F)
- affected by chemicals or ozone

3. Overview of Operation

Once the AC line cord is plugged into the outlet, the unit can be used immediately. Basic operations, including the time and ending dates, are preset.

The ES1000 is designed to work only with the ES1010 Time Cards. The clock will not function correctly using other style time cards, and using other cards may cause damage to sensors.

See "2. Getting Started".

It is easy to operate the unit. Just insert a time card. To start a time card, make sure the "number" on the card faces outward (towards operation). The card is then automatically pulled in, printed and then ejected.

! Do not let any metallic object get into the slot, including paper clips. Do not forcefully push in a card, either. These may cause the unit to malfunction.

The number of cards that can be automatically registered is a maximum of 100 cards. Card numbers 001 through 100 using duplicate numbers can cause incorrect totals.

- When a new card is inserted, the card will automatically be registered, and will print the "IN" print on the first line. The month will be printed on the first line also or on the line when the month and printing line change.
- You can print "IN" and "OUT" as many times as you want per day. Concerning the printing line, it will slide one line down each time you insert the card for "IN" print.
- The recorder will record the last imprint and automatically switch the "IN" and "OUT". You may also manually switch the column position of imprint by pushing the "IN" button or "OUT" button.

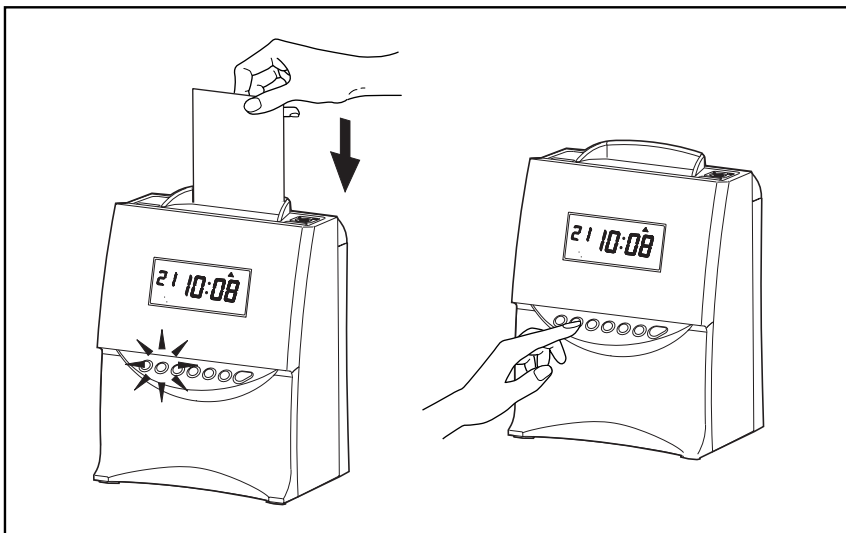

- Even if the "IN" is printed, when the present time passes the "Day Advance Time", it will consider that the "OUT" print was forgotten and will print the "IN" print on the next line.

What You Can Do With the ES1000

Schedule [Time Zone Rule]

You can select days of the week which your desired schedule is applied to. All other days of the week will be regarded as "weekend or non-scheduled work days", which you can set threshold hours and duration of auto break deduction.

Based on the programmed schedule, you can regulate the day's working rules. The day's partition that is the schedule's standard is the "Day advance time", and this time is selectable.

[Applicable days of the week]

Example: From Monday to Friday

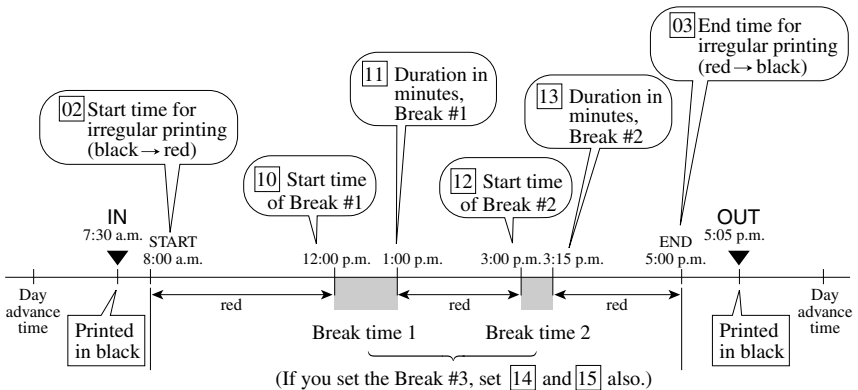

* Any punch during "break time" will be printed in black regardless of settings.

* Break time will be deducted from worked hours automatically.

[Non-selected days of the week]

Example: Saturday and Sunday

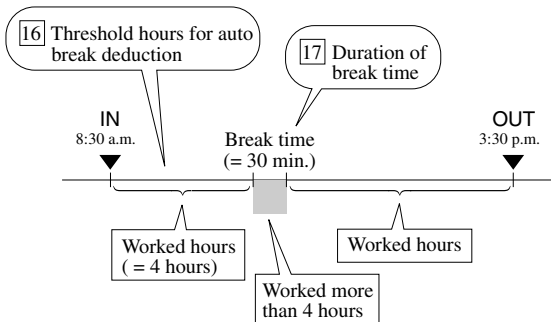

* All punches are printed in black.

Note: Numbers in square mean program number.

In addition to the start time and duration for the maximum settings of three "break times", the following settings are available to fulfill your needs.

Start and End Time for Irregular (Red) Printing

Once you set the schedule for irregular printing, printing color automatically changes according to the start/end time you've set. Color change makes it possible to easily see an employee's late in or early out.

* Note: Any punch during break time will be printed in black regardless of the above setting.

Regular Hours and Overtime

You can select calculation type from the following four choices according to how to divide and calculate "regular hours" and "overtime" when you selected "time zone" rule.

Semi-monthly and Monthly pay period overtime calculations are based on daily overtime only. To assure accurate calculations for these pay periods, please select daily regular hours limit as desired, and select "-- --" as the limit for weekly regular hours. This will "disable" the weekly OT function so that the clock will calculate properly.

[Type 1]

Basically all worked hours are accumulated as regular hours.

		Daily		Total	
IN	OUT	RH	OT	RH	OT
Au Mo 9:00A	Mo 6:00P	8:00		8:00	
Tu 9:00A	Tu 8:00P	10:00		18:00	
We 9:00A	We 10:00P	12:00		30:00	
Th 9:00A	Th 6:00P	8:00		38:00	
Fr 9:00A	Fr 7:00P	9:00		47:00	

[Type 2]

Example: *Daily regular hours: 8 hours/day, Break time: start =12:00 & 60 min./day*

		Daily		Total	
IN	OUT	RH	OT	RH	OT
Au Mo 9:00A	Mo 6:00P	8:00		8:00	
Tu 9:00A	Tu 8:00P	8:00	2:00	16:00	2:00
We 9:00A	We 6:00P	8:00		24:00	2:00
Th 9:00A	Th 7:00P	8:00	1:00	32:00	3:00

You must set limit of regular working hours per day (e.g. 8 hours per day). All worked hours, which exceed the limit, will be accumulated as overtime. In this case, "regular hours" and "overtime" will be accumulated separately.

[Type 3]

Example: Pay Period: Weekly, *Total regular hours: 40 hours/week*
 Break time: start =12:00 & 60 min./day

		Daily		Total	
IN	OUT	RH	OT	RH	OT
Au Mo 9:00A	Mo 6:00P	8:00		8:00	
Tu 9:00A	Tu 8:00P	10:00		18:00	
We 9:00A	We 10:00P	12:00		30:00	
Th 9:00A	Th 6:00P	8:00		38:00	
Fr 9:00A	Fr 7:00P	9:00		40:00	7:00

You must set limit of regular hours per week (e.g. 40 hours per week).

All worked hours shall be accumulated as regular hours until it reaches the limit. Once it goes over the limit, then, the rest of worked hours shall be accumulated as "overtime".

[Type 4]

Example: Pay Period: Weekly, *Daily regular hours: 8 hours/day, Total regular hours: 40 hours/week*, Break time: start =12:00 & 60 min./day

		Daily		Total	
IN	OUT	RH	OT	RH	OT
Au Mo 9:00A	Mo 6:00P	8:00		8:00	
Tu 9:00A	Tu 8:00P	8:00	2:00	16:00	2:00
We 9:00A	We 10:00P	8:00	4:00	24:00	6:00
Th 9:00A	Th 6:00P	8:00		32:00	6:00
Fr 9:00A	Fr 7:00P	8:00	1:00	40:00	7:00

If you set limits for both "Daily regular hours" (Daily OT) and "Total regular hours" (Weekly OT), then daily worked hours shall be calculated based on the rules for "Daily regular hours", and will take precedence over the weekly setting. If you want "Total regular hours" to be the deciding calculation for OT, then set Daily limits to "--".

If you set neither the limit for "Daily regular hours" nor "Total regular hours", all worked hours shall be accumulated as regular hours.

Priority Rule to the Days Not Scheduled in the Time Zone Schedule

By selecting "calculation priority" setting, weekend or non-scheduled work days' worked hours can be always regarded and accumulated as "Overtime" prior to other rules. If you don't select this setting, weekend or non-scheduled work days' worked hours will be accumulated in accordance with setting for the calculation type.

Example: Pay Period: Weekly, Total regular hours: 40 hours/week
 Break time: start =12:00 & 60 min./day, *Calculation priority = Selected*

		Daily		Total	
IN	OUT	RH	OT	RH	OT
Au Mo 9:00A	Mo 6:00P	8:00		8:00	
Tu 9:00A	Tu 7:00P	9:00		17:00	
We 9:00A	We 12:00P	3:00		20:00	
Th 9:00A	Th 6:00P	8:00		28:00	
Fr 9:00A	Fr 7:00P	9:00		37:00	
Sa 13:00A	Sa 5:00P		4:00		4:00

Round and Grace Time for Start and End Time

Under time zone rules of calculation, you can set round and grace time for Start Time (ST) and End Time (ET). Once you set Round Time for ST and ET, the time for calculation will be rounded forward to ST even if a person arrives earlier than ST and back to ET even if he/she leaves the office later than ET.

By setting of Grace Time for ST and ET, the time for calculation will be rounded back to ST even if a person arrives later than ST and forward to ET even if he/she leaves the office earlier than ET. You can set up to 99 minutes at maximum for round/grace time.

IN and OUT punches during the grace period are printed in black but, you can also set red printing for any punch during this period in black or red.

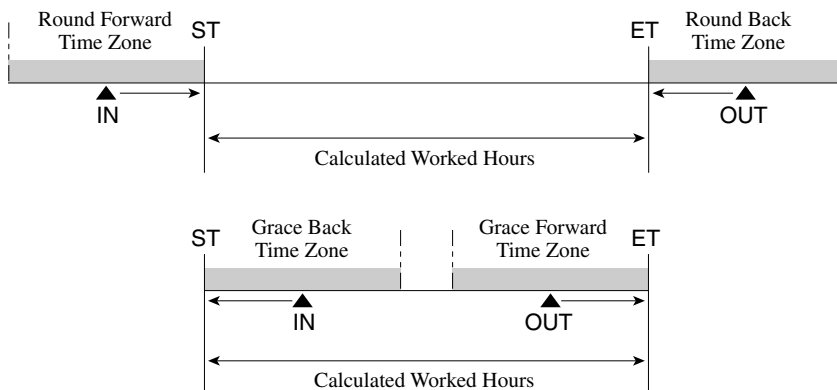

4. Settings

Preparation for Setting

Caution: If time cards were punched prior to original settings or if you wish to change Pay Periods or when the Day Advances or change the Minute print format you will need to reset ALL Time Cards. Please refer to the ALL Cards Resetting section under Additional Features.

Removing and replacing front cover.

Make sure the power is on before making setting.

- 1** Unlock the cover.
Hold the sides of the cover with both hands and pull it toward you.

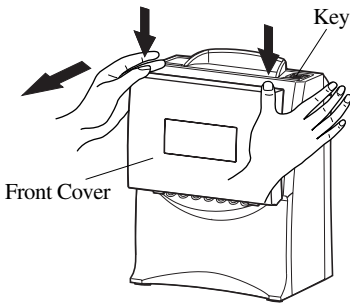

- 2** Once you push the [SETTING START/END] button, display will be as shown in the following figure. Then, push the control button for two seconds and you can go into the setting mode.

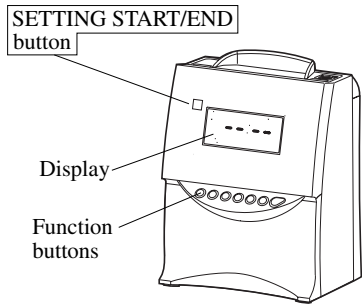

- 3** Make settings using the control button while watching the display.
Please refer to the following pages for the details of each setting.

- 4** After setting has been completed, fit the tabs at the lower sides of the cover into the holes of the unit. Then, fit another set of tabs at the top sides of the cover into the holes of the unit.

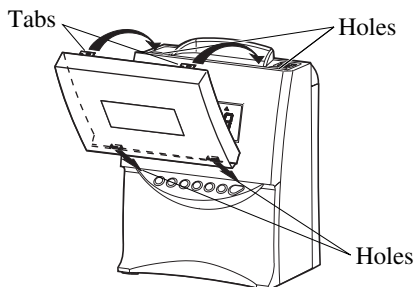

Over View of Function Buttons

With the front cover off, you will be able to access program buttons.

[SETTING START/END] button

Push this button when you go into/get out of the setting mode.

[DATE/TIME] button

Use the [DATE/TIME] button when you want to change the date and/or time. You can select the desired setting mode by pushing this button. (Make sure to push it for 2 seconds before going into the setting mode.)

[FUNCTION] button

Use the [FUNCTION] button when you want to change the pay period, print format, and so on. You can select the desired setting mode by pushing this button. (Make sure to push it for 2 seconds before going into the setting mode.)

[+] or [-] button

When you push the [+] or [-] button, you can change the set value.

[SET] button

You can set the value selected on the display by pushing the [SET] button.

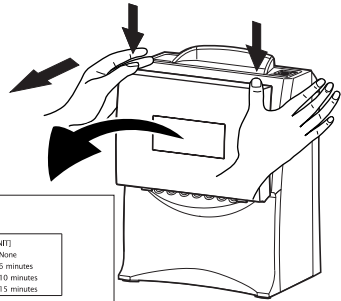

[SETTING START/END] Button

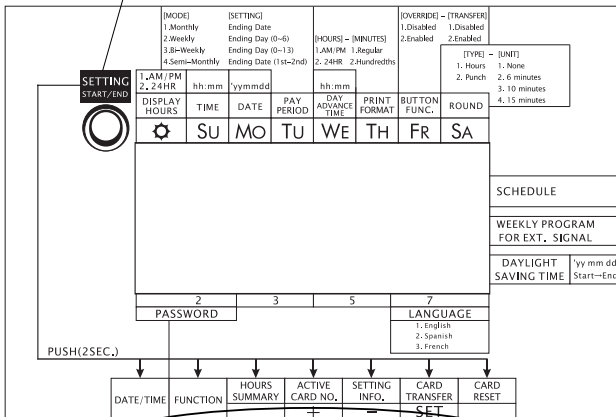

Function Buttons

Setting the Hour Display Format

Push the [SETTING START/END] button before you start setting. At that moment, " - - - - " is shown on a display and you go into setting mode.

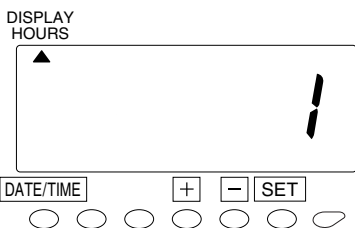
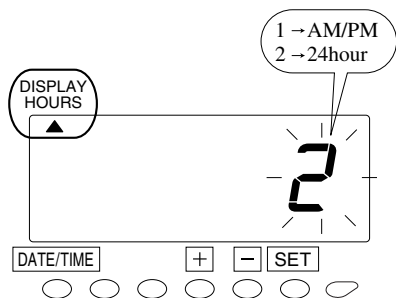

- 1 Push the [DATE/TIME] button for 2 seconds.
- 2 Once a number on the display starts flashing, make sure the "▲" mark is located under the "DISPLAY HOURS" mark.
- 3 Push the [+] or [-] button to select either "AM/PM" or "24 hour". For example, set 1 if "AM/PM" is desired.
- 4 Push the [SET] button to finish the setting. At that moment, the display will change from flashing to steady, and the setting is now completed.
- 5 Push the [SETTING START/END] button to get out of setting mode. Or press the [DATE/TIME] function button to set the time. Make sure "date" and "time" are indicated on the display and the colon is flashing. Then replace the cover and lock.

Setting the Time

Push the [SETTING START/END] button before you start setting. At that moment, " - - - - " is indicated on a display and you go into setting mode.

Example Change the time from 10:08 to 10:09.

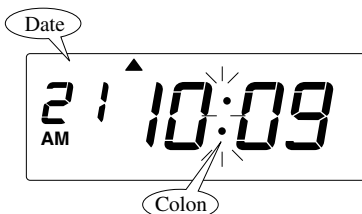
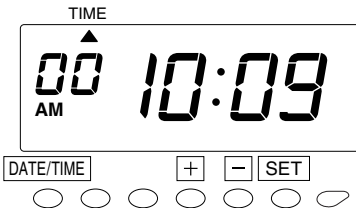
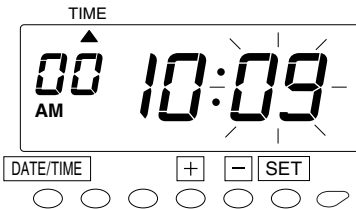
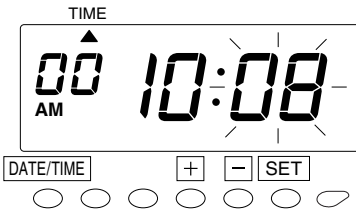
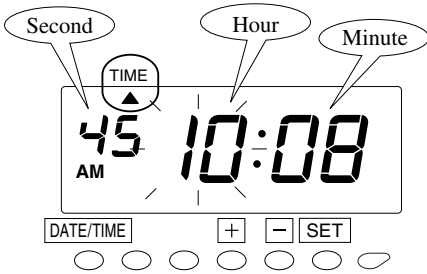

1 Push the [DATE/TIME] button for 2 seconds.

2 Once a number on the display starts flashing, position the "▲" mark under the "TIME" mark by pressing the [DATE/TIME] button.

A flashing number can be changed.

3 In case of the example, push the [SET] button because the hour is not to be changed. Now the hour of 10 o'clock has been set. At that moment, the flashing of the display will change from "Hour" to "Minute".

4 Push the [+] or [-] button to change "minute". In case of the example, push [+] button to change the minute from 08 to 09.

5 Push the [SET] button to finish the setting. At that moment, the display will change from flashing to steady, and the setting is now completed.

6 Push the [SETTING START/END] button to get out of setting mode. Or press the [DATE/TIME] function button to set the date. Make sure "date" and "time" are indicated on the display and the colon is flashing. Then replace the cover and lock.

Setting the Date

Push the [SETTING START/END] button before you start setting. At that moment, " - - - - " is indicated on a display and you go into setting mode.

Example Change the date from Oct. 20, 2004 to Oct. 21, 2004.

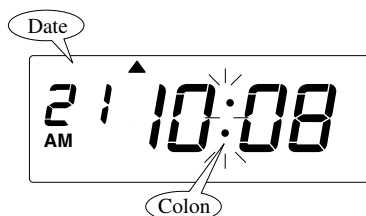
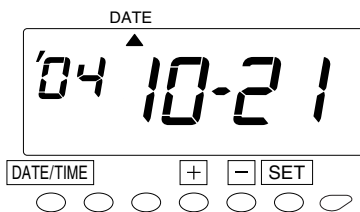
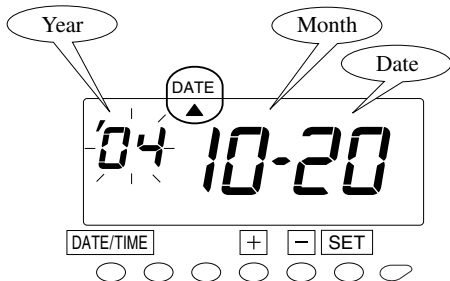

1 Push the [DATE/TIME] button for 2 seconds.

2 Once a number on the display starts flashing, position the "▲" mark under the "DATE" mark by pressing [DATE/TIME] button.

A flashing number can be changed.

3 In case of the example, push the [SET] button because the year 2004 is not to be changed. Now the year of 2004 has been set. At that moment, flashing of the display will change from "Year" to "Month".

4 In case of the example, push the [SET] button again because the month of October is not to be changed. Now the month of October has been set. At that moment, flashing of the display will change from "Month" to "Date".

5 Push the [+] or [-] button to change "date". In case of the example, push [+] button to change the date from 20 to 21.

6 Push the [SET] button to finish the setting. At that moment, the display will change from flashing to steady, and the setting is now completed.

7 Push the [SETTING START/END] button to get out of setting mode. Make sure "date" and "time" are indicated on the display and the colon is flashing. Then replace the cover and lock.

Setting Pay Period and Pay Period Ending Date

The clock default is "weekly pay period".

All time cards will be reset automatically after pay ending date.

You will not be allowed to change pay period while in a current pay period. Error message E-49 will be displayed. You may change a current pay period after you reset all time cards. Please refer to "Card Resetting" section of this manual.

Push the [SETTING START/END] button before you start setting. At that moment, " - - - - " is indicated on a display and you go into setting mode.

Monthly

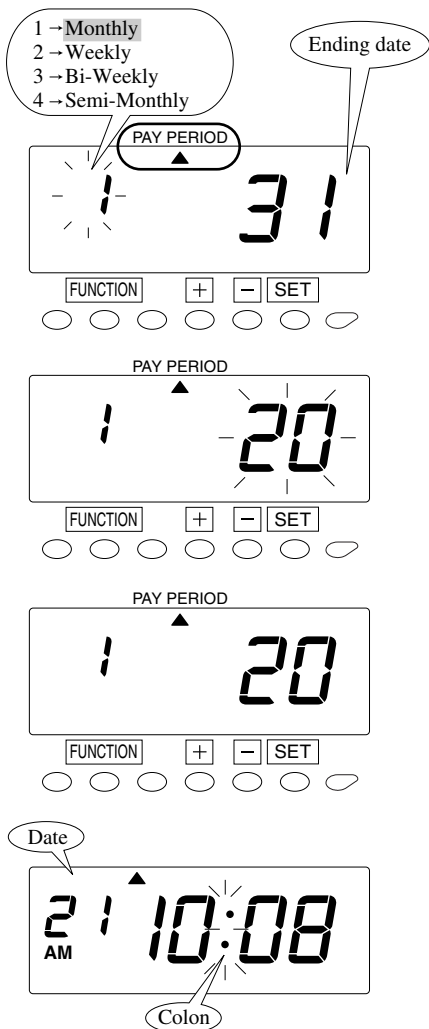

1 Push the [FUNCTION] button for 2 seconds.

2 Once a number on the display starts flashing, make sure the "▲" mark is located under the "PAY PERIOD" mark.

A flashing number can be changed.

3 In the case of monthly ending, Push the [+] or [-] button to set the left-side number at "1" and then push the [SET] button. At that moment, flashing of the display will change to the closing date.

4 Push the [+] or [-] button to set the desired date. For example, if the ending date is the 20th, set the ending date at 20.

5 Push the [SET] button to finish the setting. At that moment, the display will change from flashing to steady, and the setting is now completed.

Date and time are recorded on the card when you set the monthly ending.

6 Push the [SETTING START/END] button to get out of setting mode. Make sure "date" and "time" are indicated on the display and the colon is flashing. Then replace the cover and lock.

Weekly

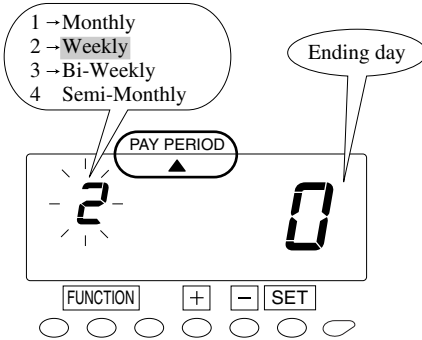

Example

Today	Ending day
July 23 Friday	July 25 Sunday

0 1 2
 └───┬───┬───┘
 ↑ ↑ ↑
 0 1 2

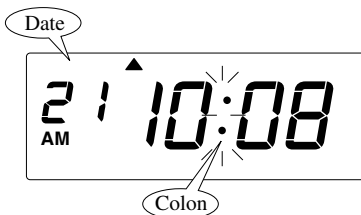
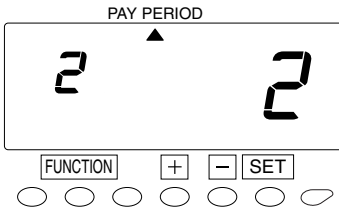
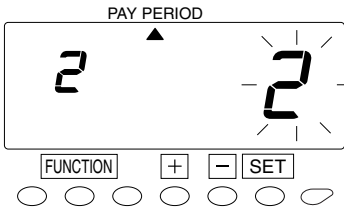

1 Push the [FUNCTION] button for 2 seconds.

2 Once a number on the display starts flashing, make sure the "▲" mark is located under the "PAY PERIOD" mark.

A flashing number can be changed.

3 In the case of weekly ending, push the [+] or [-] button to set the left-side number at "2" and then push the [SET] button. At that moment, flashing of the display will change to the ending day.

4 Next, set the desired ending day, which comes within a week from today. The pay period ending date is the number of days from the date you are setting the clock.

Example: Assume that today is Friday, July 23, 2004 and the ending day is Sunday. As illustrated in the figure on the left, ending day (Sunday) is two days after.

Push the [+] or [-] button to set the right-side number of the display at "2".

5 Push the [SET] button to finish the setting. At that moment, the display will change from flashing to steady, and the setting is now completed.

Day of the week and time are recorded on the card when you set the weekly ending.

6 Push the [SETTING START/END] button to get out of setting mode. Make sure "date" and "time" are indicated on the display and the colon is flashing. Then replace the cover and lock.

Bi-Weekly

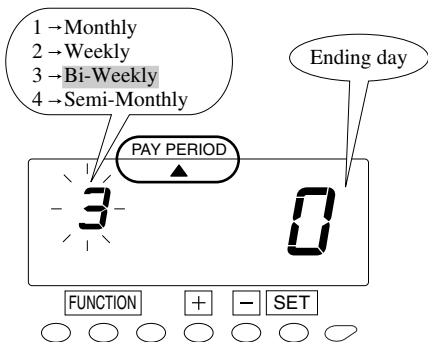

Example

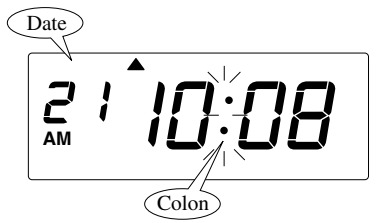
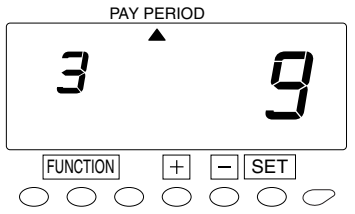
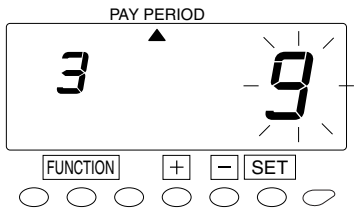
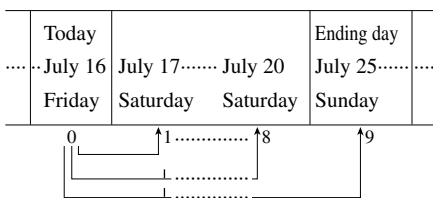

1 Push the [FUNCTION] button for 2 seconds.

2 Once a number on the display starts flashing, make sure the "▲" mark is located under the "PAY PERIOD" mark.

A flashing number can be changed.

3 In the case of bi-weekly ending, push the [+] or [-] button to set the left-side number at "3" and then push the [SET] button. At that moment, flashing of the display will change to the ending day.

4 Next, set the desired ending day, which comes within two weeks from today. The pay period ending date is the number of days from the date you are setting the clock.

Example: Assume that today is Friday, July 16, 2004 and the ending day is Sunday the week after next. As illustrated in the figure on the left, ending day (Sunday) is nine days after.

Push the [+] or [-] button to set the right-side number of the display at "9".

5 Push the [SET] button to finish the setting. At that moment, the display will change from flashing to steady, and the setting is now completed.

Day of the week and time are recorded on the card when you set the bi-weekly ending.

6 Push the [SETTING START/END] button to get out of setting mode. Make sure "date" and "time" are indicated on the display and the colon is flashing. Then replace the cover and lock.

Semi-Monthly

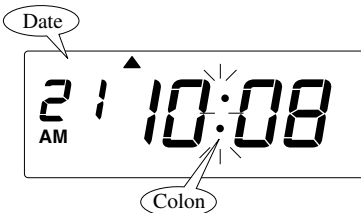
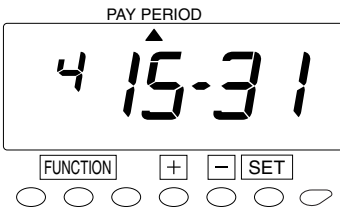
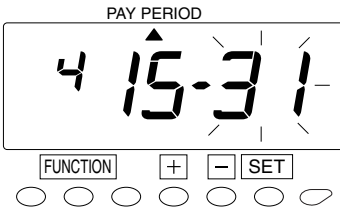
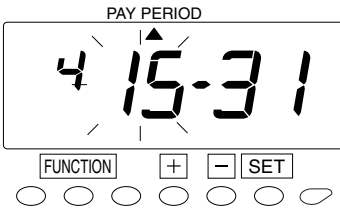
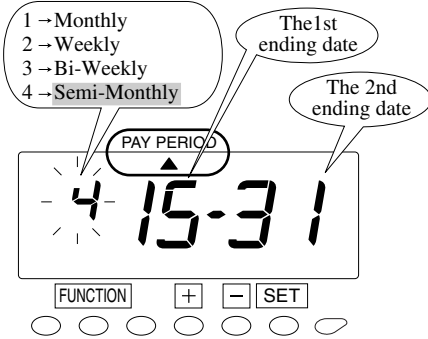

- 1 Push the [FUNCTION] button for 2 seconds.
- 2 Once a number on the display starts flashing, make sure the "▲" mark is located under the "PAY PERIOD" mark.

A flashing number can be changed.

- 3 In the case of semi-monthly ending, push the [+] or [-] button to set the left-side number at "4" and then push the [SET] button. At that moment, flashing of the display will change to the 1st ending date.

- 4 Push the [+] or [-] button to set the desired date. For example, if the 1st ending date is the 15th, set the ending date at 15 and then push the [SET] button. At that moment, flashing of the display will change to the 2nd ending date.

- 5 Push the [+] or [-] button to set the desired date. For example, if the 2nd ending date is the end of each month, set the ending date at 31 and then push the [SET] button to finish the setting. At that moment, the display will change from flashing to steady, and the setting is now completed.

Date and time are recorded on the card when you set the semi-monthly ending.

- 6 Push the [SETTING START/END] button to get out of setting mode. Make sure "date" and "time" are indicated on the display and the colon is flashing. Then replace the cover and lock.

Setting the Day Advance Time

The Day Advance Time refers to the time when printing shifts to the next line on a time card for the next day. This function enables the punch out time record to print on the same line of the previous working day even if leaving time is after midnight. Changing the Day Advance Time will also change the time of day the Day of week will change.

You will not be allowed to change day advance time while in a current pay period. Error message E-49 will be displayed. You may change a current day advance time after you reset all time cards. Please refer to "Card Resetting" section of this manual.

Push the [SETTING START/END] button before you start setting. At that moment, "----" is indicated on a display and you go into setting mode.

Example Change the line shift time from 0:00 to 7:00.

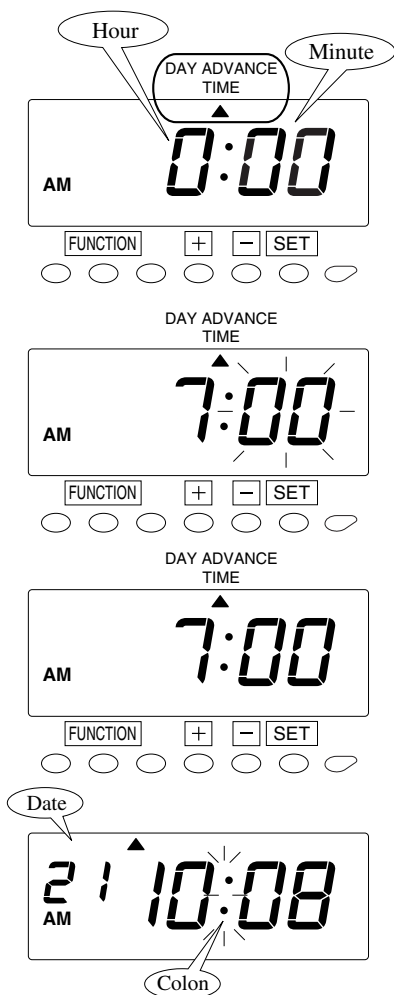

- 1** Push the [FUNCTION] button for 2 seconds.
- 2** Once a number on the display starts flashing, position the "▲" mark under the "DAY ADVANCE TIME" mark by pressing [FUNCTION] button.
- 3** Push the [+] or [-] button to change the line shift time. In case of the example, push the [+] button to change the hour from 5 to 7. At that moment, flashing of the display will change from "Hour" to "Minute".
- 4** In case of the example, push the [SET] button once more because the minute is not to be changed. At that moment, the display will change from flashing to steady, and the setting is now completed.
- 5** Push the [SETTING START/END] button to get out of setting mode. Make sure "date" and "time" are indicated on the display and the colon is flashing. Then replace the cover and lock.

Selecting the Print Format

You will not be allowed to change minute print format while in a current pay period. Error message E-49 will be displayed. You may change a current minute print format after you reset all time cards. Please refer to "Card Resetting" section of this manual.

Push the [SETTING START/END] button before you start setting. At that moment, "-- --" is indicated on a display and you go into setting mode.

Example Change the print format of the hour to "AM/PM" and the minute to "1/100" min.

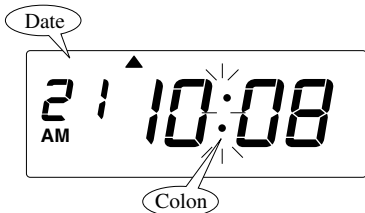
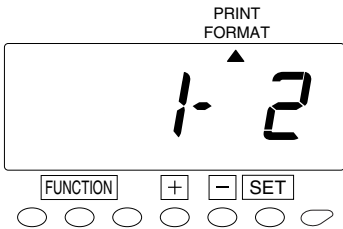
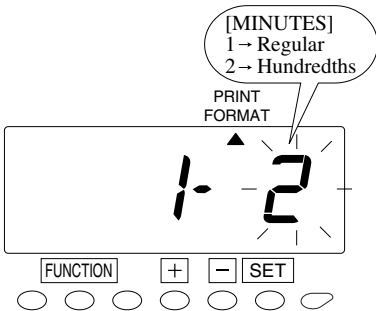
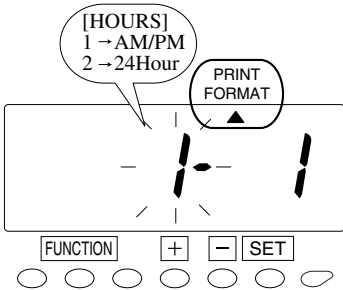

1 Push the [FUNCTION] button for 2 seconds.

2 Once a number on the display starts flashing, position the "▲" mark under the "PRINT FORMAT" mark by pressing [FUNCTION] button.

A flashing number can be changed.

3 In case of the example, push the [+] or [-] button to set the left-side number at "1" to select "AM/PM" format and then push the [SET] button. At that moment, flashing of the display will change to the right-side number.

4 Push the [+] or [-] button to set the desired minute type. In case of the 1/100 min., set the right-side number of the display at "2".

Even if you select "2", only calculation result is printed in the hundredths (1/100) min. → IN and OUT punches are always printed in regular (1/60) min.

5 Push the [SET] button to finish the setting. At that moment, the display will change from flashing to steady, and the setting is now completed.

6 Push the [SETTING START/END] button to get out of setting mode. Make sure "date" and "time" are indicated on the display and the colon is flashing. Then replace the cover and lock.

Enabling Override and Transfer Functions

Enabling these functions allows employees to move time totals on card or transfer to another card. (Not recommended.) See Additional Features sections for how these features are used.

Push the [SETTING START/END] button before you start setting. At that moment, " - - - - " is indicated on a display and you go into setting mode.

Example Make both "Override" and "Card Transfer" functions enabled.

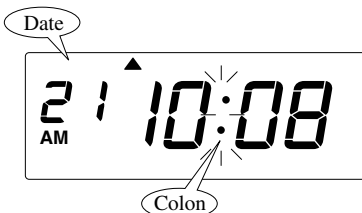
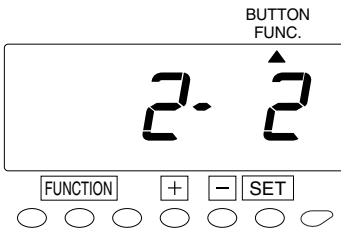
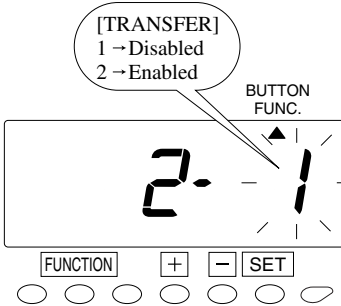
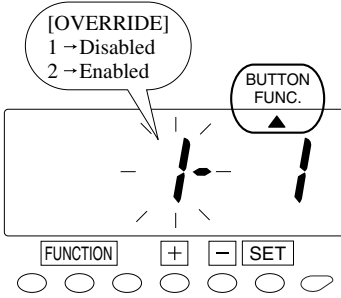

1 Push the [FUNCTION] button for 2 seconds.

2 Once a number on the display starts flashing, position the "▲" mark under the "BUTTON FUNC." mark by pressing [FUNCTION] button.

A flashing number can be changed.

3 In case of the example, push the [+] or [-] button to set the left-side number at "2" to make "Override" function enabled and then push the [SET] button. At that moment, flashing of the display will change to the right-side number.

4 In case of the example, push the [+] or [-] button to set the right-side number at "2" to make "Card Transfer" function enabled and then push the [SET] button. At that moment, the display will change from flashing to steady, and the setting is now completed.

5 Push the [SETTING START/END] button to get out of setting mode. Make sure "date" and "time" are indicated on the display and the colon is flashing. Then replace the cover and lock.

Selecting Rounding Rules

For "Rounding", there're 2 settings: "Types of Rounding" and "Rounding Unit". For "Types of Rounding", there're "Hours Rounding" and "Punch Time Rounding", and you can choose one.

For "Hours Rounding", the recorder calculates the hours from "IN" punch to "OUT" punch, and then, rounds that result with the "Rounding Unit" that you have selected.

For "Punch Time Rounding", the recorder rounds both time of "IN" and "OUT" punches, and then, calculates the hours from the time "IN" to "OUT". (Recommended)

Breakpoint means the point where it will raise or omit fractions.

Selection #2 Punch Rounding is recommended.

Push the [SETTING START/END] button before you start setting. At that moment, " - - - - " is shown on a display and you go into setting mode.

Example Type of rounding is "Punch". Rounding unit is "15 minutes".

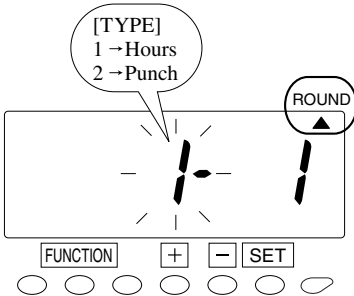

- 1** Push the [FUNCTION] button for 2 seconds.
- 2** Once a number on the display starts flashing, position the "▲" mark under the "ROUND" mark by pressing [FUNCTION] button.

A flashing number can be changed.

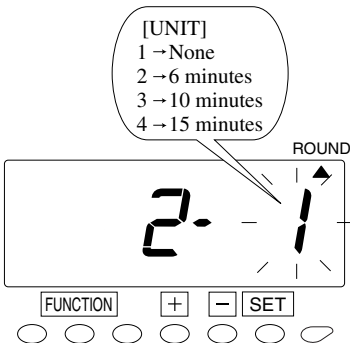

- 3** In case of the example, push the [+] or [-] button to set the left-side number at "2" to select "punch time rounding" and then push the [SET] button. At that moment, flashing of the display will change from "Type of Rounding" to "Rounding Unit".

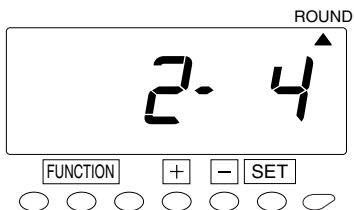

4 In case of the example, push the [+] or [-] button to set the right-side number at "4" to select rounding unit of "15 minutes" and then push the [SET] button. At that moment, the display will change from flashing to steady, and the setting is now completed.

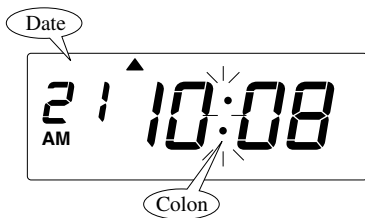

5 Push the [SETTING START/END] button to get out of setting mode. Make sure "date" and "time" are indicated on the display and the colon is flashing. Then replace the cover and lock.

Schedule (Setting Calculation Rules)

Selecting the schedule or calculating rules for the schedule determines the features that may be set. First determine which zone will best meet your needs. In most cases the Free Zone schedule meets most company's needs.

Free Zone or "Open Shift" rules permits employees to punch IN and OUT without being assigned to a fixed schedule. Employee's times are calculated using elapsed time or punched IN time subtracted from punched OUT time.

Using this selection is the easiest and most popular form of totalizing employee's hours worked.

Free Zone allows for Auto Lunch deduction and permits you to select the length of the break. You may also choose the number of regular hours worked before overtime is calculated. You may also select the maximum hours an employee is on the clock when it would be considered a "forgotten" out punch.

Using the Free Zone calculating rules will permit easy, accurate totalizing of your payroll hours.

Time Zone or Fixed Schedule rules are designed for companies that have *all* employees on one assigned shift. Time Zone rules allows for assignment of "start" and "stop" times of the shift with GRACE times with early or late punches printing in RED. Time Zone permits three break periods.

Time Zone rules may also be used with Free Zone rules under certain circumstances. Taking advantage of all these features will require additional programming time but will offer an advanced time and attendance system.

The ES1000 has many advanced features offered only in the more expensive Time and Attendance Systems. Selecting the type of schedule or calculating rule, Free Zone or Time Zone, activates the features available. See the chart below.

Setting the Schedule

Program No.	Description	Free Zone Rule*	Time Zone Rule
01	Calculation Rule	1	2
02	Start Time for Irregular Printing (Black → Red)		Yes
03	End Time for Irregular Printing (Red → Black)		Yes
04	Limit of Regular Hours per Day		Yes
05	Limit of Regular Hours per Week		Yes
06	Duration of Round Time (Start & End Shift Times)		Yes
07	Duration of Grace Time (Start & End Shift Times)		Yes
08	Red Printing for Grace Time Period		Yes
09	Rules for Working Days Outside Regular Schedule		Yes
10	Start Time of Break #1		Yes
11	Duration in Minutes, Break #1		Yes
12	Start Time of Break #2		Yes
13	Duration in Minutes, Break #2		Yes
14	Start Time of Break #3		Yes
15	Duration in Minutes, Break #3		Yes
16	Threshold Hours for Auto Break Deduction	Yes	Yes
17	Duration of Break Time	Yes	Yes
18	Threshold Hours for Overtime Calculation	Yes	
19	Limit Hours for OUT punch	Yes	

*Free Zone Rule Recommended

Selecting Free Zone calculations (#1) under Program 1, you will have access only to program numbers 16, 17, 18, and 19. (See chart above.)

Free Zone or Open Shift (easy and most popular)

You can regulate the worked hours of the day by setting the "Limit hours for OUT punch".

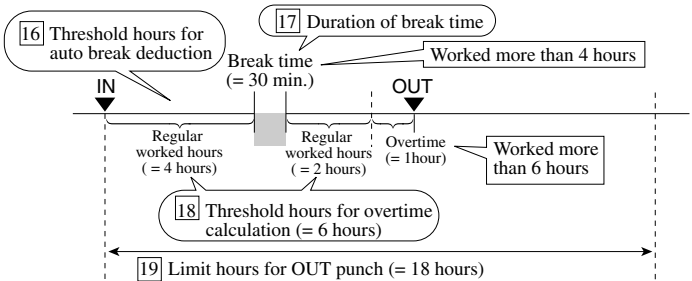

Note: Numbers in square mean program number.

Push the [SETTING START/END] button before you start setting. At that moment, "----" is indicated on a display and you go into setting mode.

Set the "[01] Calculation rule".

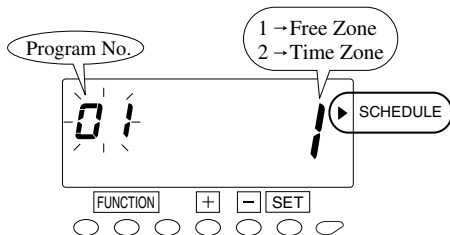

1 Push the [FUNCTION] button for 2 seconds.

2 Once a number on the display starts flashing, position the "▲" mark next to the "SCHEDULE" mark by pressing the [FUNCTION] button.

A flashing number can be changed.

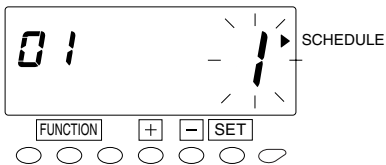

3 Make sure the left-side number indicates "01" and push the [SET] button.

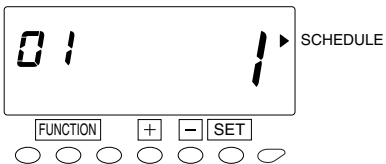

4 Push the [+] or [-] button and set at 1 to select "Free Zone" rule.

Order Option	Calculation Rules
1	Free Zone
2	Time Zone

5 Push the [SET] button to fix the setting value. At that moment, the display will change from flashing to steady.

Threshold Hours for Auto Break (Lunch) Deduction

Setting the threshold hours for auto deduct. This is the minimum time (hours worked) before an auto lunch deduct can occur.

Set the "**16** Threshold hours for auto break deduction".

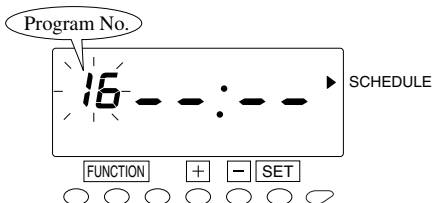

6 Push the [SET] button again. Then, the left-side number starts flashing.

A flashing number can be changed.

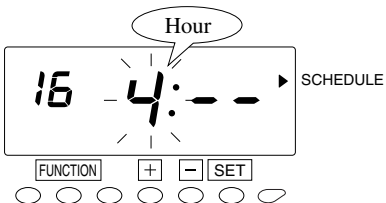

7 Push the [+] or [-] button to select "16" and push the [SET] button. At that moment, flashing of the display will change to "Hour". In case of the example, push the [+] or [-] button to set at "4" and push the [SET] button. At that moment, flashing of the display will change from "Hour" to "Minute".

Range of values: 1-24 hour(s)
(" -- " makes the function disabled.)

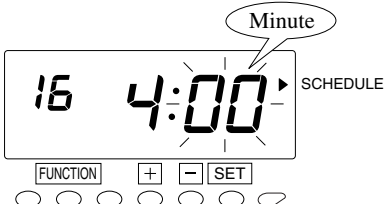

8 In this case, push the [+] or [-] button to set at "00". And then, push the [SET] button. At that moment, the display will change from flashing to steady.



Duration of break time or the length of the "lunch" (hours/minutes) that can be deducted.

Set the "17 Duration of break time".

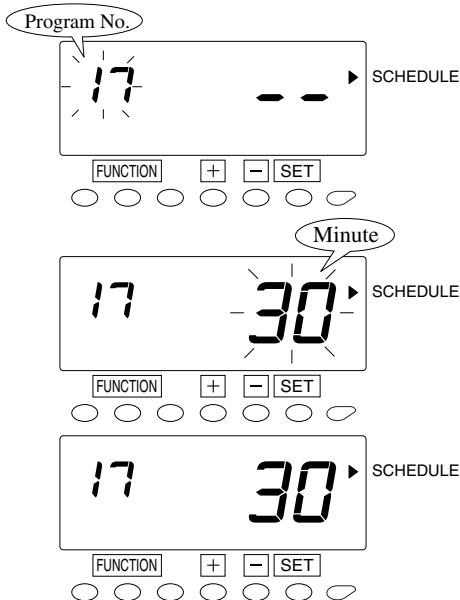

9 Push the [SET] button again to set the left-side number at "17" by pressing the [+] button. Once you push the [SET] button, flashing of the display will change to "Minutes". In case of the example, push the [+] or [-] button to set at "30" and push the [SET] button. At that moment, the display will change from flashing to steady.

Range of values: 1-99 min.
 ("--" makes the function disabled.)

Threshold of overtime calculation or regular hours worked before time worked is considered Overtime.

Set the "18 Threshold hours of overtime calculation".

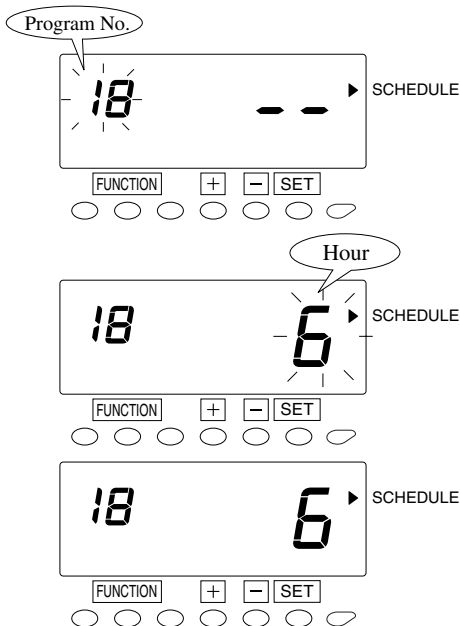

10 Push the [SET] button again to set the left-side number at "18" by pressing the [+] button. Once you push the [SET] button, flashing of the display will change to "Hour". In case of the example, push the [+] or [-] button to set at "6" and push the [SET] button. At that moment, the display will change from flashing to steady.

Range of values: 1-24 hour(s)
 ("--" makes the function disabled.)

Limit hours for OUT punch.

This is the time "on the clock" from the last IN punch before the clock should consider a forgotten punch. This allows for the next punch to be treated as an IN punch.

Set the "19 Limit hours for the OUT punch".

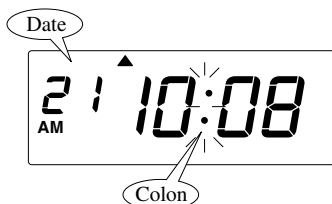
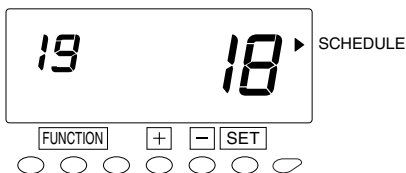
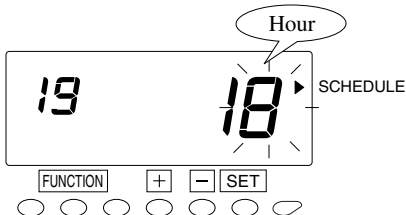
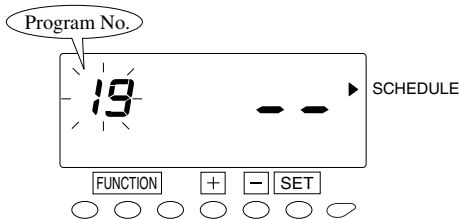

11 Finally, push the [SET] button again to set the left-side number at "19" by pressing the [+] button. Once you push the [SET] button, flashing of the display will change to "Hour". In case of the example, push the [+] or [-] button to set at "18" and push the [SET] button. At that moment, the display will change from flashing to steady.

Range of values: 1-48 hour(s)
 ("---" makes the function disabled.)

12 Push the [SETTING START/END] button to get out of setting mode. Make sure "date" and "time" are indicated on the display and the colon is flashing. Then replace the cover and lock.

Time Zone or Fixed Shift (ideal when everyone is on the same schedule.)

You can select days of the week which your desired schedule is applied to. All other days of the week will be regarded as "weekend or non-scheduled work days", which you can set threshold hours and duration of auto break deduction.

Program No.	Description	Free Zone Rule*	Time Zone Rule
01	Calculation Rule	1	2
02	Start Time for Irregular Printing (Black → Red)		Yes
03	End Time for Irregular Printing (Red → Black)		Yes
04	Limit of Regular Hours per Day		Yes
05	Limit of Regular Hours per Week		Yes
06	Duration of Round Time (Start & End Shift Times)		Yes
07	Duration of Grace Time (Start & End Shift Times)		Yes
08	Red Printing for Grace Time Period		Yes
09	Rules for Working Days Outside Regular Schedule		Yes
10	Start Time of Break #1		Yes
11	Duration in Minutes, Break #1		Yes
12	Start Time of Break #2		Yes
13	Duration in Minutes, Break #2		Yes
14	Start Time of Break #3		Yes
15	Duration in Minutes, Break #3		Yes
16	Threshold Hours for Auto Break Deduction	Yes	Yes
17	Duration of Break Time	Yes	Yes
18	Threshold Hours for Overtime Calculation	Yes	
19	Limit Hours for OUT punch	Yes	

*Free Zone Rule Recommended

Selecting Time Zone calculations (#2) under Program 1 allows access to program numbers 02 through 17.

[Applicable days of the week]

Example: From Monday to Friday

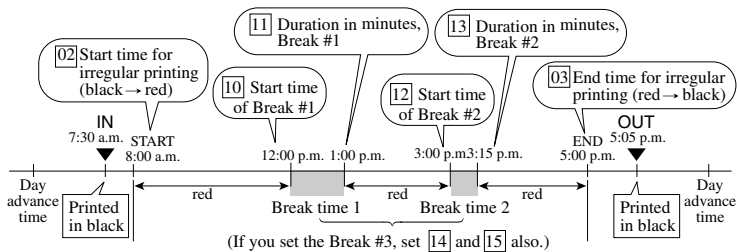

- * Any punch during "break time" will be printed in black regardless of settings.
- * Break time will be deducted from worked hours automatically.

[Non-selected days of the week]

Example: Saturday and Sunday

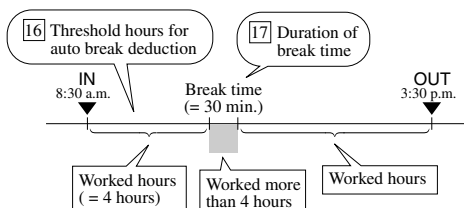

* All punches are printed in black.

Note: Numbers in square mean program number.

Push the [SETTING START/END] button before you start setting. At that moment, " - - - - " is indicated on a display and you go into setting mode.

Set the "01 Calculation rule". Selecting "1: Free Zone" is recommended for most operations.

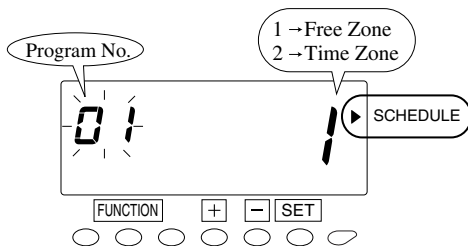

1 Push the [FUNCTION] button for 2 seconds.

2 Once a number on the display starts flashing, position the "▲" mark next to the "SCHEDULE" mark by pressing the [FUNCTION] button.

A flashing number can be changed.

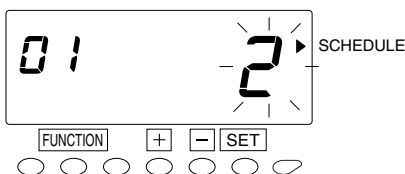

3 Make sure the left-side number indicates "01" and push the [SET] buttons.

4 Push the [+] or [-] button and set at 2 to select "Time Zone" rule.

Order Option	Calculation Rules
1	Free Zone
2	Time Zone

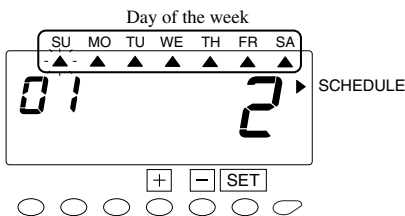

5 Push the [SET] button to fix the setting value. At that moment, flashing of the display will change to "Days of the Week".

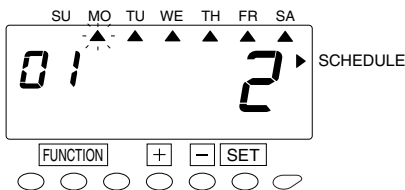

6 In case of the example, push the [-] button not to set schedule on Sunday. Then, flashing will change to the "▲" mark under "MO". Push the [+] button five times to set the schedule from Monday to Friday. At that moment, the "▲" mark under "SA" will flash. Then, push the [-] button not to set schedule on Saturday and push the [SET] button. At that moment, flashing of the display will change from flashing to steady.

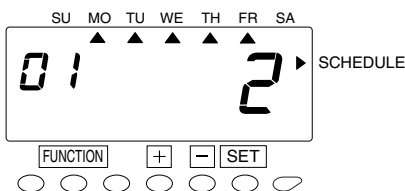

Applicable days of the week can be selected by the [+] button. The [-] button should be used for the days of the week on which the program isn't set.

Ribbon Color Change

If you have selected the "Time Zone" calculation rule, Program numbers 2 and 3 allow for programming employee punches, outside the normal work schedule, to print in "RED" to flag early out or late in punches. The example below punches after 8:01 AM and before 5:00 PM will print in RED.

Program 2 lets you select the time that the clock will print in RED. You must select the minute *before* the program time. Example: To have the clock print in RED at 8:01 AM you must set 8:00 AM.

Program 3 lets you select the time the clock will print in BLACK. You must select the minute at the program time. Example: To have the clock print in BLACK at 5:00 PM you must set 5:00 PM.

Set the "02 Start time for irregular printing (black → red)".

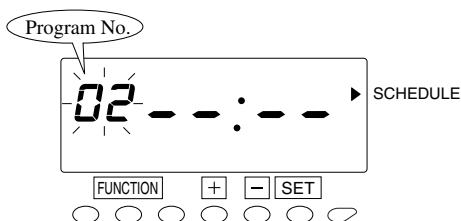

7 Push the [SET] button again. Then, the left-side number starts flashing.

A flashing number can be changed.

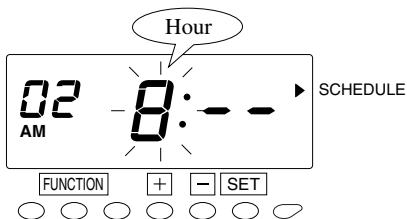

8 Push the [+] or [-] button to set the left-side number at "02" and push the [SET] button. At that moment, flashing of the display will change to "Hour". In case of the example, push the [+] or [-] button to set at "8 (a.m.)" and push the [SET] button. At that moment, flashing of the display will change from "Hour" to "Minute".

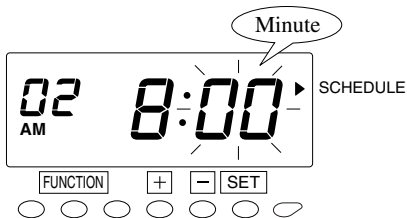

9 In this case, push the [+] or [-] button to set at "30". And then, push the [SET] button. At that moment, the display will change from flashing to steady.

Set the "03 End time for irregular printing (red → black)".

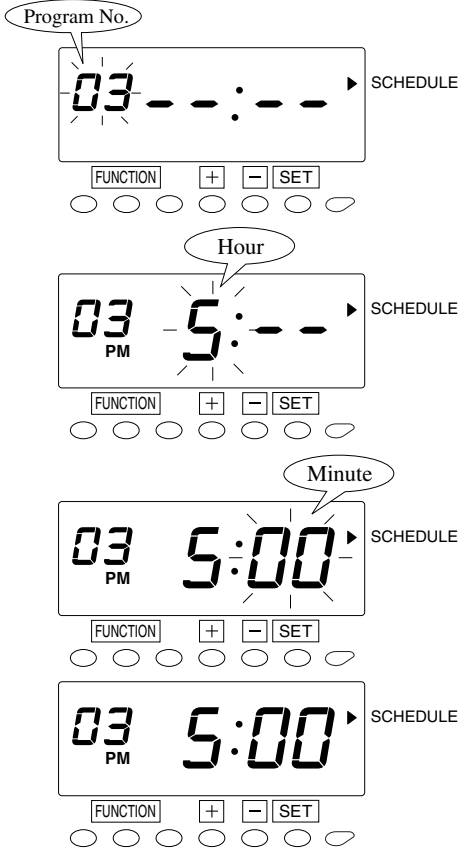

10 Next, push the [SET] button again to set the left-side number at "03" by pressing the [+] or [-] button. Once you push the [SET] button, flashing of the display will change to "Hour". In case of the example, push the [+] or [-] button to set at "5 (p.m.)" and push the [SET] button. At that moment, flashing of the display will change from "Hour" to "Minute".

11 In this case, push the [+] or [-] button to set at "30". And then, push the [SET] button. At that moment, the display will change from flashing to steady.

Set the "10 Start time of Break #1".

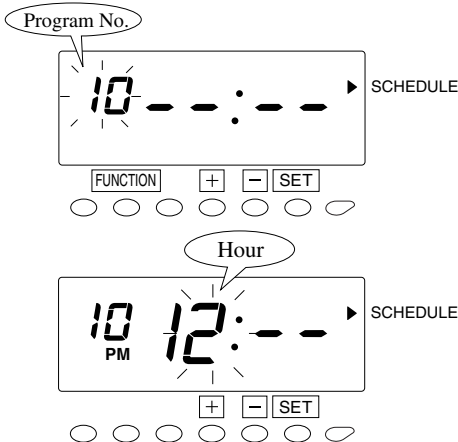

12 Push the [SET] button again to set the left-side number at "10" by pressing the [+] or [-] button. Once you push the [SET] button, flashing of the display will change to "Hour". In case of the example, push the [+] or [-] button to set at "12 (p.m.)" and push the [SET] button. At that moment, flashing of the display will change from "Hour" to "Minute".

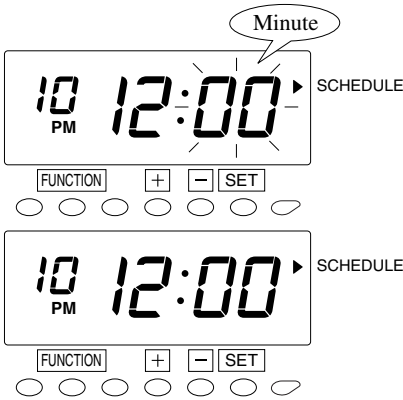

13 In this case, push the [+] or [-] button to set at "00". And then, push the [SET] button. At that moment, the display will change from flashing to steady.

Set the "**11** Duration in minutes, Break #1".

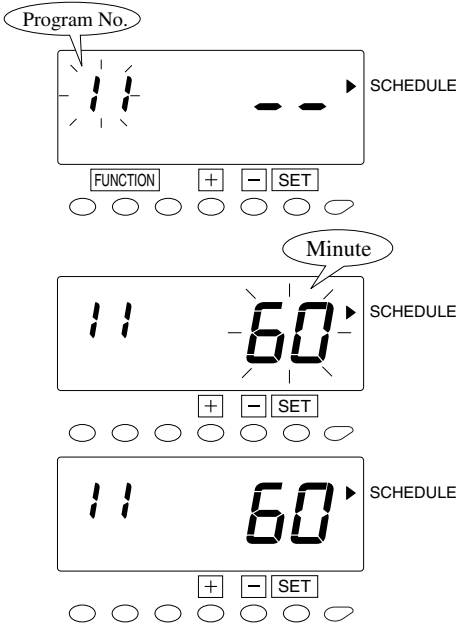

14 Push the [SET] button again and select "11" by pressing the [+] or [-] button. Once you push the [SET] button, flashing of the display will change to "Minute". In case of the example, push the [+] or [-] button to set at "60" and push the [SET] button. At that moment, the display will change from flashing to steady.

Range of values: 1-99 min.
 ("--" makes the function disabled.)

Set the "**12** Start time of Break #2".

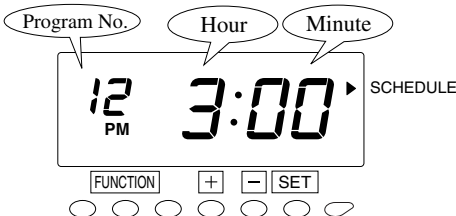

15 Make settings for the "Start time of break #2" in the same manner as for the "Start time of break #1", as illustrated in the figure on the left.

Set the "13 Duration in minutes, Break #2".

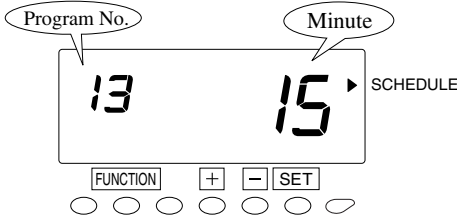

16 Make settings for the "Duration in minutes, Break #2" in the same manner as for the "Duration in minutes, Break #1", as illustrated in the figure on the left.

Program #14 and #15 (not shown) are for Break #3.

[For non-selected days of the week (which the above schedules aren't applied to.)]

Set the "16 Threshold hours for auto break deduction".

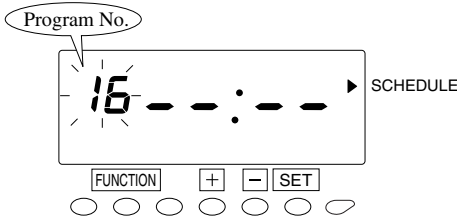

17 Push the [SET] button again. Then, the left-side number starts flashing.

A flashing number can be changed.

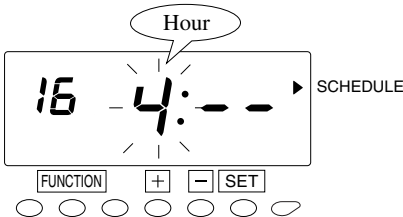

18 Push the [+] or [-] button to select "16" and push the [SET] button. At that moment, flashing of the display will change to "Hour". In case of the example, push the [+] or [-] button to set at "4" and push the [SET] button. At that moment, flashing of the display will change from "Hour" to "Minute".

Range of values: 1-24 hour(s)
("--" makes the function disabled.)

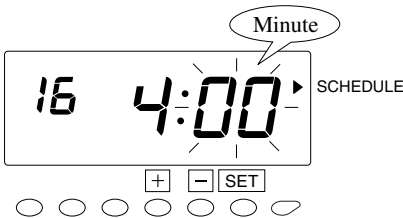

19 In this case, push the [+] or [-] button to set at "00". And then, push the [SET] button. At that moment, the display will change from flashing to steady.

Set the "17 Duration of break time".

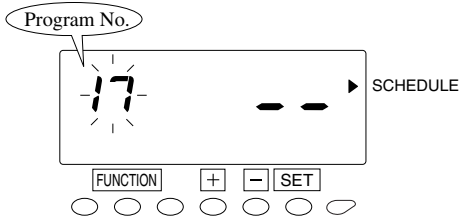

20 Push the [SET] button again to set the left-side number at "17" by pressing the [+] button. Once you push the [SET] button, flashing of the display will change to "Minutes". In case of the example, push the [+] or [-] button to set at "30" and push the [SET] button. At that moment, the display will change from flashing to steady.

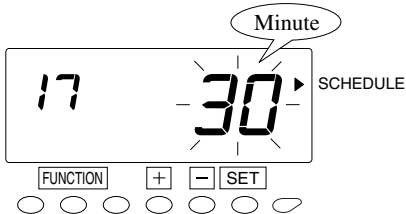

Range of values: 1-99 min.
(" -- " makes the function disabled.)

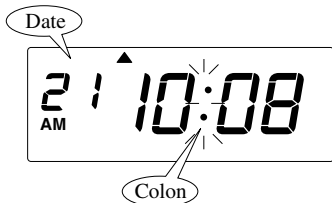
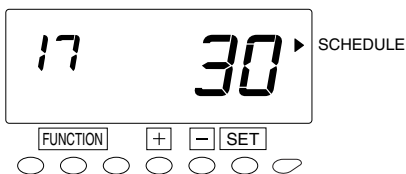

21 Push the [SETTING START/END] button to get out of setting mode. Make sure "date" and "time" are indicated on the display and the colon is flashing. Then replace the cover and lock.

Overtime Calculation

Basically, all worked hours are accumulated as regular hours.

By setting maximum length of regular hours per day or week, you can fix how to divide worked hours into regular hours and overtime.

Semi-monthly and Monthly pay period overtime calculations are based on daily overtime only. To assure accurate calculations for these pay periods, please select daily regular hours limit as desired, and select " - - - - " as the limit for weekly regular hours. This will "disable" the weekly OT function so that the clock will calculate properly.

[Daily Regular Hours]

Example: Daily regular hours: 8 hours/day, Break time: start =12:00 & 60 min./day

		Daily		Total	
IN	OUT	RH	OT	RH	OT
Mo 9:00A	Mo 6:00P	8:00		8:00	
Tu 9:00A	Tu 3:00P	8:00	2:00	16:00	2:00

You must set limit of regular hours per day (e.g. 8 hours per day).

All worked hours, which exceed the limit, will be accumulated as overtime.

In this case, "regular hours" and "overtime" will be accumulated separately.

Push the [SETTING START/END] button before you start setting. At that moment, " - - - - " is indicated on a display and you go into setting mode.

Set the "04" Limit of regular hours per day".

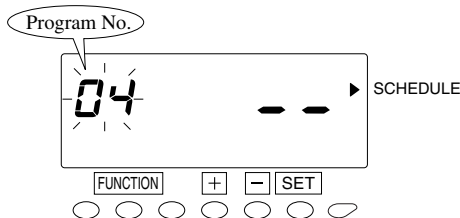

1 Push the [FUNCTION] button for 2 seconds.

2 Once a number on the display starts flashing, position the "▲" mark next to the "SCHEDULE" mark by pressing the [FUNCTION] button.

A flashing number can be changed.

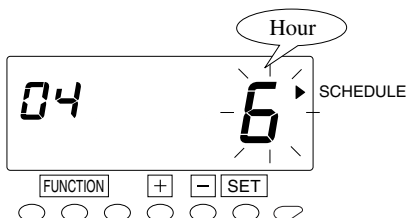

3 Push the [+] or [-] button and select "04". Once you push the [SET] button, flashing of the display will change to the "Hour".

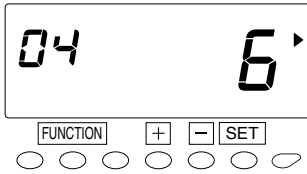

SCHEDULE

- 4** Push the [+] or [-] button to set the desired hours. In case of the example, push the [+] or [-] button to set at "6" and push the [SET] button. At that moment, the display will change from flashing to steady.

Range of values: 1-24 hour(s)
 ("--" makes the function disabled.)

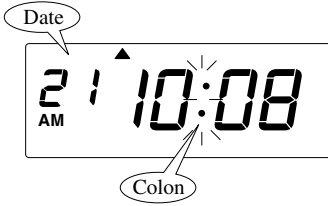

- 5** Push the [SETTING START/END] button to get out of setting mode. Make sure "date" and "time" are indicated on the display and the colon is flashing. Then replace the cover and lock. Or push the set button to advance to Program #05, Setting total regular hours per week.

[Total Regular Hours per Week]

Example: Pay period: Weekly, *Total regular hours: 40 hours/week*
 Break time: start =12:00 & 60 min./day

		Daily		Total	
IN	OUT	RH	OT	RH	OT
Mo 9:00A	Mo 6:00P	8:00		8:00	
Tu 9:00A	Tu 8:00P	10:00		18:00	
We 9:00A	We 10:00P	12:00		30:00	
Th 9:00A	Th 6:00P	8:00		38:00	
Fr 9:00A	Fr 7:00P	9:00		40:00	7:00

You must set limit of regular hours per week (e.g. 40 hours per week).

All worked hours shall be accumulated as regular hours until it reaches the limit. Once it goes over the limit, then, the rest of worked hours shall be accumulated as "overtime".

Set the "[05] Limit of regular hours per week".

Push the [SETTING START/END] button before you start setting. At that moment, " - - - - " is indicated on a display and you go into setting mode.

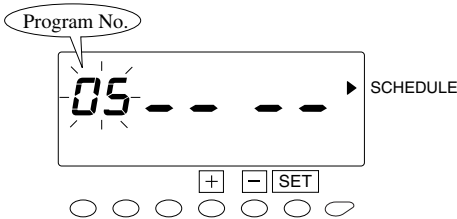

1 Push the [FUNCTION] button for 2 seconds.

2 Once a number on the display starts flashing, position the "▲" mark next to the "SCHEDULE" mark by pressing the [FUNCTION] button.

A flashing number can be changed.

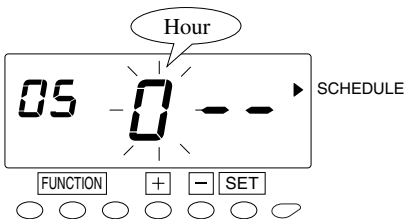

3 Push the [+] button to select "05". Once you push the [SET] button, flashing of the display will change to the "Hour".

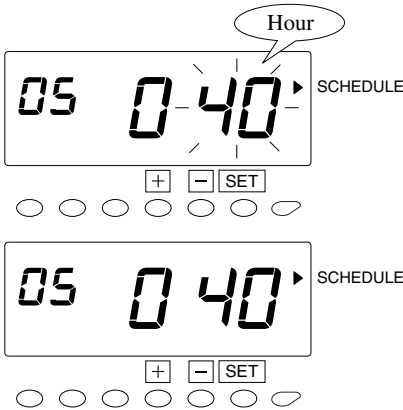

4 Push the [+] or [-] button to set the desired hours. In case of the example, push the [+] button to set the first one digit at "0" and push the [SET] button.

At that moment, the flashing of the display will change to the last two digits. Then, push the [+] or [-] button to set at "40" and push the [SET] button. At that moment, the display will change from flashing to steady.

Range of values: 1- 168 hour(s)
 ("--" makes the function disabled.)

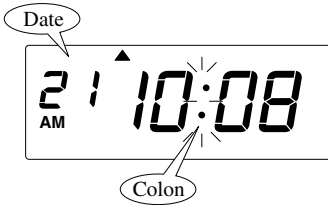

5 Push the [SETTING START/END] button to get out of setting mode. Make sure "date" and "time" are indicated on the display and the colon is flashing. Then replace the cover and lock. Or push the [SET] button to advance to program #06, Setting round & grace times.

[Combination of "Daily Regular Hours" and "Total Regular Hours"]

If you set limits for both "Daily regular hours" (Daily OT) and "Total regular hours" (Weekly OT), then daily worked hours shall be calculated based on the rules for "Daily regular hours", and will take precedence over the weekly setting. If you want "Total regular hours" to be the deciding calculation for OT, then set Daily limits to "--".

Example: Pay Period: Weekly, *Daily regular hours: 8 hours/day, Total regular hours: 40 hours/week, Break time: start =12:00 & 60 min./day*

		Daily		Total	
IN	OUT	RH	OT	RH	OT
Mo 9:00A	Mo 6:00P	8:00		8:00	
Tu 9:00A	Tu 8:00P	8:00	2:00	16:00	2:00
We 9:00A	We 10:00P	8:00	4:00	24:00	6:00
Th 9:00A	Th 6:00P	8:00		32:00	6:00
Fr 9:00A	Fr 7:00P	8:00	1:00	40:00	7:00
⋮					

Priority Rule to the Days Not Scheduled in the Time Zone Schedule

If you select "1" in the program number 09, any worked hours on weekend or non-scheduled work days will be regarded and accumulated as "overtime" prior to other settings.

Example: Pay Period: Weekly, Total regular hours: 40 hours/week
Break time: start =12:00 & 60 min./day, *Calculation priority = Selected*

		Daily		Total	
IN	OUT	RH	OT	RH	OT
Mo 9:00A	Mo 6:00P	8:00		8:00	
Tu 9:00A	Tu 7:00P	9:00		17:00	
We 9:00A	We 12:00P	3:00		20:00	
Th 9:00A	Th 6:00P	8:00		28:00	
Fr 9:00A	Fr 7:00P	9:00		37:00	
Sa 13:00A	Sa 5:00P		4:00		4:00
⋮					

Round and Grace Time for Start/End Time (ST/ET)

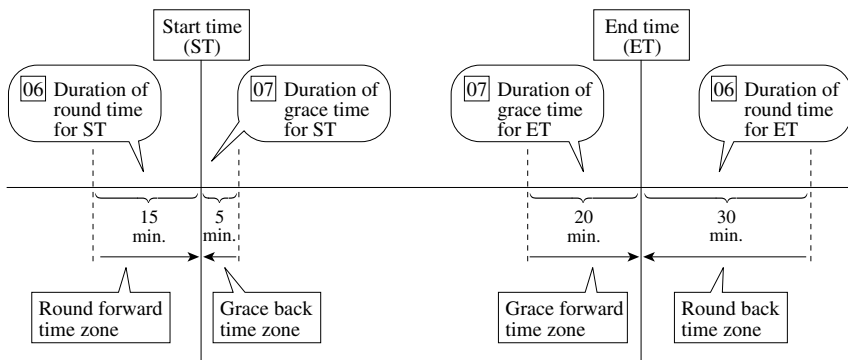

Push the [SETTING START/END] button before you start setting. At that moment, " - - - " is indicated on a display and you go into setting mode.

Set the "06 Duration of round time (start & end shift times)".

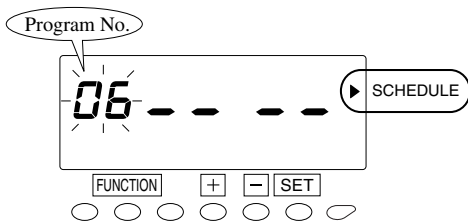

1 Push the [FUNCTION] button for 2 seconds.

2 Once a number on the display starts flashing, position the "▲" mark next to the "SCHEDULE" mark by pressing the [FUNCTION] button.

A flashing number can be changed.

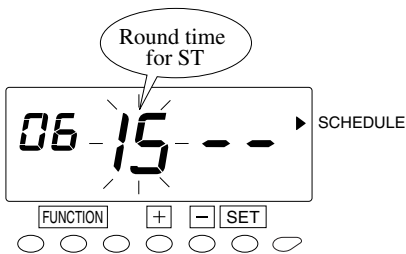

3 Push the [+] or [-] button to set the left-side number at "06" and push the [SET] button. At that moment, flashing of the display will change to the middle numbers which indicate round-forward period (min.) for IN punch before the start time. In case of the example, push the [+] or [-] button to set at "15" and push the [SET] button. At that moment, flashing of the display will change to the right-side numbers.

Range of values: 1-99 min.
(" - - " makes the function disabled.)

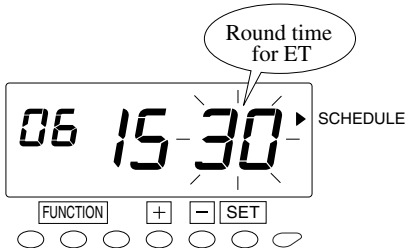

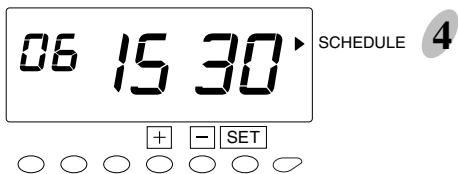

4 The right-side numbers indicate round-back period (min.) for OUT punch after the end time. In this case, push the [+] or [-] button to set at "30". And then, push the [SET] button. At that moment, the display will change from flashing to steady.

Set the "07 Duration of grace time (start & end shift times)".

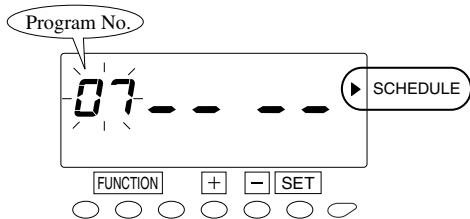

5 Next, push the [SET] button again to set the left-side number at "07" by pressing the [+] button. Once you push the [SET] button, flashing of the display will change to the middle numbers which indicate grace-back period (min.) for IN punch after the start time. In case of the example, push the [+] or [-] button to set at "5" and push the [SET] button. At that moment, flashing of the display will change to the right-side numbers.

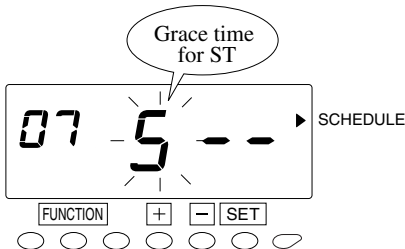

Range of values: 1-99 min.
 ("--" makes the function disabled.)

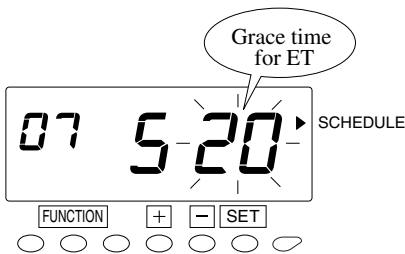

6 The right-side numbers indicate grace-forward period (min.) for OUT punch after the end time. In this case, push the [+] or [-] button to set at "20". And then, push the [SET] button. At that moment, the display will change from flashing to steady.



Set the "08 Red printing for grace time period".

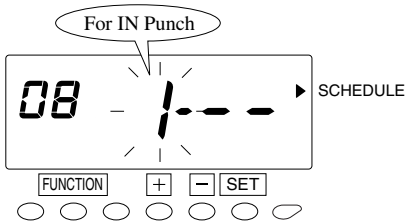
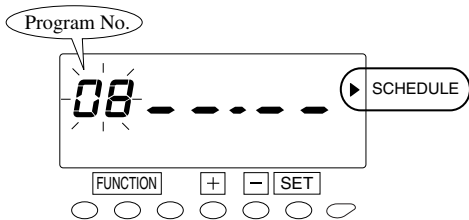

For OUT Punch

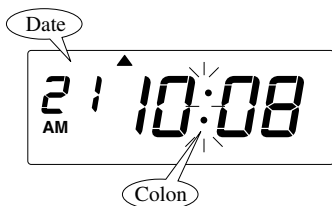
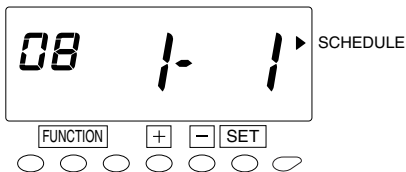
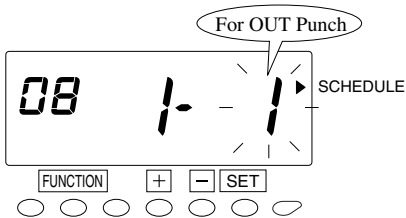

7 Again, push the [SET] button to set the left-side number at "08" by pressing the [+] button. At that moment, flashing of the display will change to the middle numbers which control "red" printing for IN punch after the start time. If you want to print any IN punch after the start time in red, push the [+] or [-] button to set at "1" and push the [SET] button.

Option	Action
1	Red printing for any punch during the grace time for irregular recognition.
--	Any punch during grace time period will be printed in black.

Note: All punches during break time will be printed in black regardless of above setting.

8 At that moment, flashing of the display will change to the right-side numbers, which control "red" printing for OUT punch before the end time. If you want to print any OUT punch before the end time in red, push the [+] or [-] button to set at "1" and push the [SET] button.

9 Push the [SETTING START/END] button to get out of setting mode. Make sure "date" and "time" are indicated on the display and the colon is flashing. Then replace the cover and lock.

Setting the Weekly Program for External Time Signal

You can set weekly time schedule for external signal up to 48 programs. Each program can have different duration.

Push the [SETTING START/END] button before you start setting. At that moment, " - - - - " is indicated on a display and you go into setting mode.

Example

Program No.	Day of the Week	Time	Duration
01	Mon. - Fri.	9:00 a.m.	5 sec.
02	Mon. - Fri.	5:30 p.m.	7 sec.

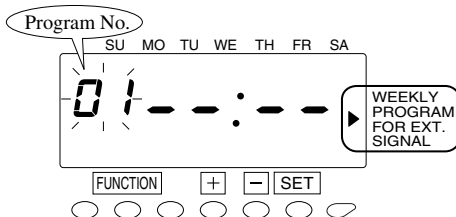

1 Push the [FUNCTION] button for 2 seconds.

2 Once a number on the display starts flashing, position the "▲" mark next to the "WEEKLY PROGRAM FOR EXT. SIGNAL" mark by pressing [FUNCTION] button. At that moment, the flashing digits indicate program number.

A flashing number can be changed.

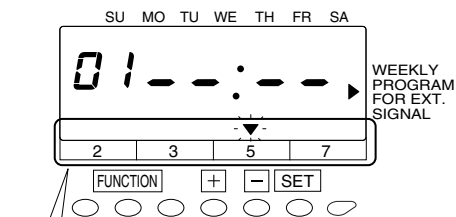

3 Set the program No. 1.

Push the [SET] button. At that moment, flashing of the display will change to "duration" of signal. In case of the example, push the [+] or [-] button and position the "▲" mark over the "5" to select 5 seconds and then push the [SET] button. At that moment, flashing of the display will change to "Days of the Week".

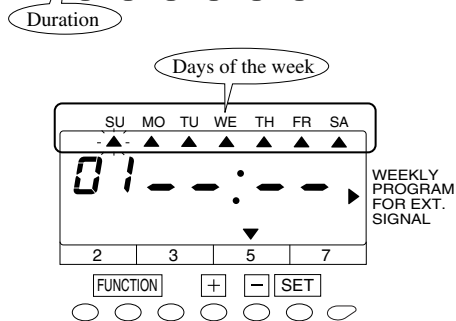

4 In case of the example, push the [-] button not to set external signal on Sunday. Then, flashing will move to "▲" mark under "MO". Push the [+] button five times to set the signal from Monday to Friday. At that moment, "▲" mark under "SA" will flash. Then, push the [-] button not to set external signal on Saturday and [SET] button. At that moment, the flashing of the display will change to "Hour".

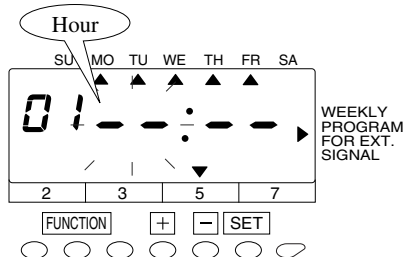

Applicable days of the week can be selected by the [+] button. The [-] button should be used for the days of the week on which the program isn't set.

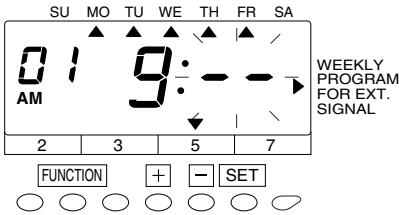

5 In case of the example, push the [+] or [-] button to set "9" and push the [SET] button. At that moment, flashing of the display will change from "Hour" to "Minute".

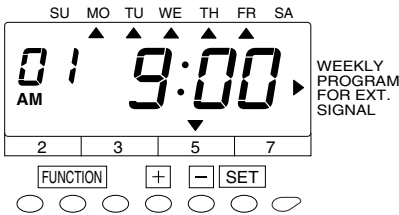

6 Push the [+] or [-] button to set "00". Then, push the [SET] button.

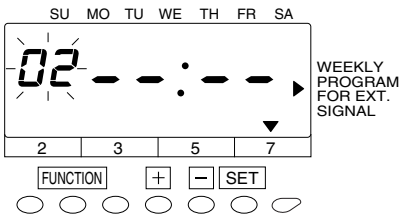

7 Set the program No. 2.

Push the [SET] button again and the "Program No." starts flashing. Push the [+] button to set at "02", and then, push the [SET] button.



Make settings for the Program No. 2 in the same manner as for the Program No. 1, as illustrated in the figure on the left, and push the [SET] button to finish the setting. At that moment, the display will change from flashing to steady, and the setting is now completed.

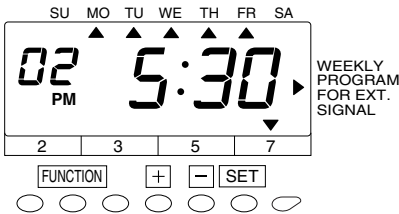

8 Push the [SETTING START/END] button to get out of setting mode. Make sure "date" and "time" are indicated on the display and the colon is flashing. Then replace the cover and lock.

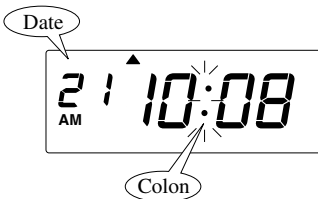

Confirming the Weekly Program

Refer to the Step 1 and 2 in the previous setting section. Every time you push the [+] button, the program number changes (01→02→03 ...) and you can confirm each setting.

After confirming the settings, push the [SETTING START/END] button to get out of setting mode. Make sure "date" and "time" are indicated on the display and the colon is flashing. Then replace the cover and lock.

Changing the Weekly Program

Refer to the Step 1 and 2 in the previous setting section and select the program number, which you want to change settings. Once the desired program number starts flashing, push the [SET] button and change settings in the same manner as you originally set.

Deleting the Weekly Program

Refer to the Step 1 and 2 in the previous setting section and select the program No., which you want to delete settings. Once the desired program No. starts flashing, push the [SET] button and delete the "▼" mark over the selected duration by pressing the [-] button. Then, push the [SET] button. At that moment, the display will change as illustrated in the following figure and now settings are deleted.

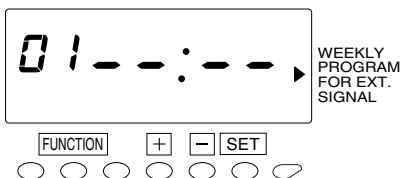

Push the [SETTING START/END] button to get out of setting mode. Make sure "date" and "time" are indicated on the display and the colon is flashing. Then replace the cover and lock.

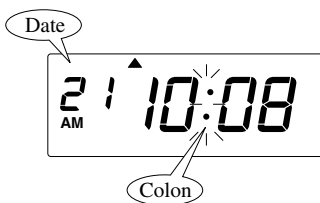

Setting the Auto Daylight Saving Change

Daylight saving time function

1 D.S.T. execution time

At 2:00 a.m. on the first day of summer time, the clock automatically gains one hour to show 3:00 a.m. When 2:00 a.m. comes on the last day of the summer time period, it loses one hour and returns to 1:00 a.m.

2 Setting D.S.T.

Example:

Start date Sunday, April 3, 2005

End date Sunday, October 30, 2005

If set as the above, the unit remembers the start date as the first Sunday of April and the end date as the first Sunday of October. Once set, the unit automatically updates the settings every year thereafter. No further manual setting is necessary.

When there is a time change between the "IN" and "OUT" because of the "Daylight Savings" settings, an "S" will appear on the calculated result as a record mark.

The "S" mark may not be printed properly when "Daylight Savings" turned on because of other changes in settings.

The setting for daylight saving time will be _____
described using the following example.

Example

Today (present day)	Wednesday, January 26, 2005	
Starting date of daylight saving time	Sunday, April 3, 2005	The first Sunday of April
Ending date of daylight saving time	Sunday, October 30, 2005	The last Sunday of October

Push the [SETTING START/END] button before you start setting. At that moment, " - - - - " is indicated on a display and you go into setting mode.

1 Push the [FUNCTION] button for 2 seconds.

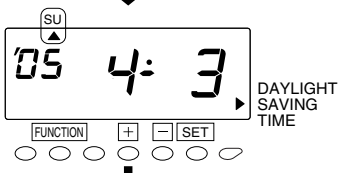
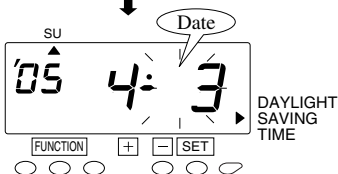
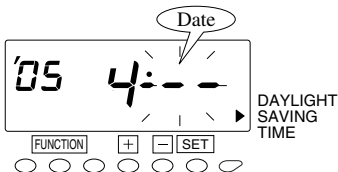
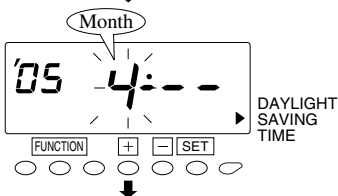
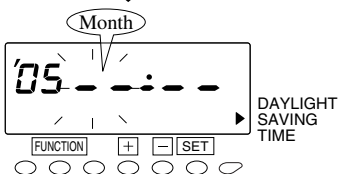
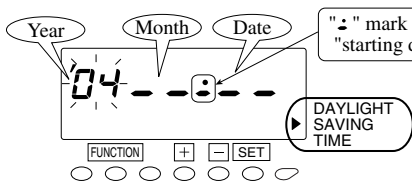

2 Once a number on the display starts flashing, position the "▲" mark next to the "DAYLIGHT SAVING TIME" mark by pressing the [FUNCTION] button.

A flashing number can be changed.

Set the "starting date".

3 In case of the example, push the [+] or [-] button to set at "05" and push the [SET] button. At that moment, flashing of the display will change from "Year" to "Month".

4 Push the [+] or [-] button to set at "4" and push the [SET] button. At that moment, flashing of the display will change from "Month" to "Date".

5 Push the [+] or [-] button to set at "3" and push the [SET] button. At that moment, "starting date" on the display will change from flashing to steady and the "▲" mark is displayed under "SU". Wait a few seconds, then go on to the Step 6.

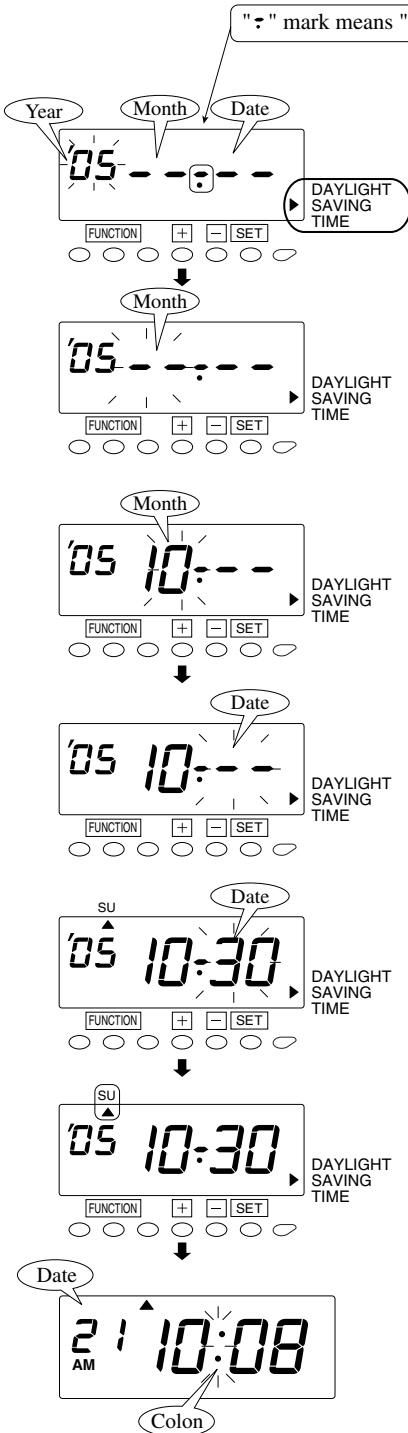

Set the "ending date".

6 Next, push the [SET] button. At that moment, flashing of the display will change from "Year" to "Month".

7 Push the [+] or [-] button to set at "10" and push the [SET] button. At that moment, flashing of the display will change from "Month" to "Date".

8 Push the [+] or [-] button to set at "30" and push the [SET] button. At that moment, "starting date" on the display will change from flashing to steady and the "▲" mark is displayed under "SU".

9 Push the [SETTING START/END] button to get out of setting mode. Make sure "date" and "time" are indicated on the display and the colon is flashing. Then replace the cover and lock.

Deleting the Daylight Saving Time Settings

To delete and cancel the daylight saving time settings, change the display of "Month" of the starting setting to "--".

Example

To change "April 3, 2005" of "starting date" and delete daylight saving time settings.

Push the [SETTING START/END] button before you start setting. At that moment, "--" is indicated on a display and you go into setting mode.

- 1 Push the [FUNCTION] button for 2 seconds.

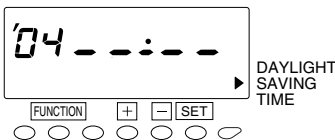
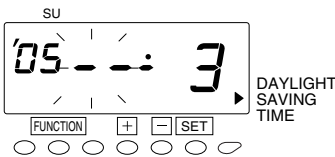
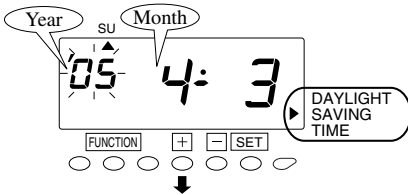

- 2 Once a number on the display starts flashing, position the "▲" mark next to the "DAYLIGHT SAVING TIME" mark by pressing the [FUNCTION] button.

A flashing number can be changed.

- 3 Push the [SET] button and flashing of the display will change from "Year" to "Month". Next, push the [+] or [-] button to set at "--".

- 4 Push the [SET] button twice. This cancels the daylight saving time settings.

- 5 Push the [SETTING START/END] button to get out of setting mode. Make sure "date" and "time" are indicated on the display and the colon is flashing. Then replace the cover and lock.

Setting the Language

This function is available if weekly or bi-weekly ending has been selected in the pay period setting.

The print language can be selected from the following three.

Push the [SETTING START/END] button before you start setting. At that moment, " - - - - " is shown on a display and you go into setting mode.

Example

Order Options	Print Example: Thursday 15:30
1. English	TH 15:30
2. Spanish	JU 15:30
3. French	JE 15:30

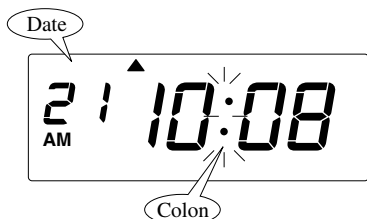
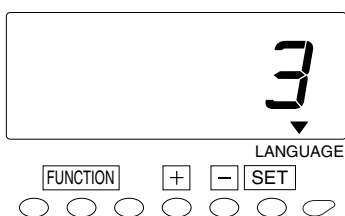
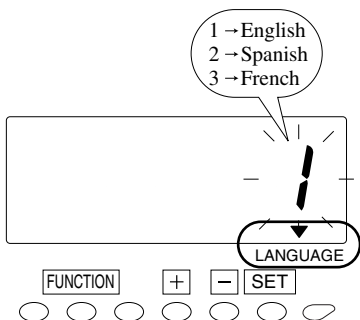

- 1** Push the [FUNCTION] button for 2 seconds.
- 2** Once a number on the display starts flashing, position the "▲" mark over the "LANGUAGE" mark by pressing the [FUNCTION] button.
- 3** Push the [+] or [-] button to select the desired language. For example, set 3 if "French" is desired.
- 4** Push the [SET] button to finish the setting. At that moment, the display will change from flashing to steady, and the setting is now completed.
- 5** Push the [SETTING START/END] button to get out of setting mode. Make sure "date" and "time" are indicated on the display and the colon is flashing. Then replace the cover and lock.

Setting the Password

When the password is set, you are asked to enter it. If the password you entered does not coincide with the setting, you cannot change the setting values.

You may select any 4-digit number from 0001 to 9998 as your password.

Note: Numbers "0000" and "9999" are not valid as password.

All settings must be reset if you forget the password. Refer to "8. Resetting".

Push the [SETTING START/END] button before you start setting. At that moment, "----" is indicated on a display and you go into setting mode.

Example Set the password "1234".

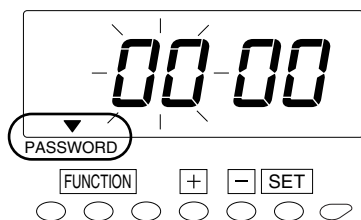

- 1 Push the [FUNCTION] button for 2 seconds.
- 2 Once a number on the display starts flashing, position the "▲" mark over the "PASSWORD" mark by pressing the [FUNCTION] button.

A flashing number can be changed.

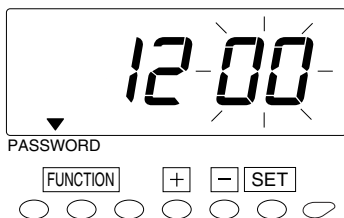

- 3 Change the first two digits.

In case of the example, push the [+] or [-] button to set at "12" and then, push the [SET] button. At that moment, flashing of the display will change to the last two digits.

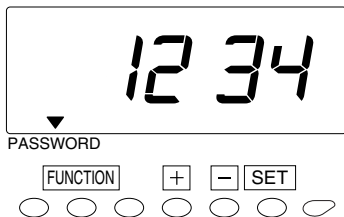

- 4 Change the last two digits.

Next, push the [+] or [-] button to set at "34" and then, push the [SET] button. At that moment, the display will change from flashing to steady, and the setting is now completed.

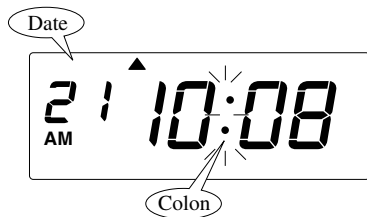

- 5 Push the [SETTING START/END] button to get out of setting mode. Make sure "date" and "time" are indicated on the display and the colon is flashing. Then replace the cover and lock.

How to Change Settings When the Password Is Set

Once the password is set, you are requested to enter the current password before changing any settings.

Push the [SETTING START/END] button before you start setting. At that moment, " - - - - " is indicated on a display and you go into setting mode.

Example The current password is "1234" and go into the "DATE/TIME" setting mode.

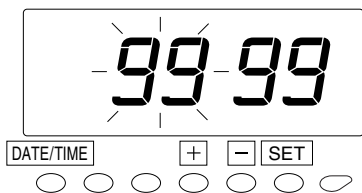

- 1 Push the [DATE/TIME] button for two seconds. Then, "9999" will be indicated on the display and the first two digits flash.

A flashing number can be changed.

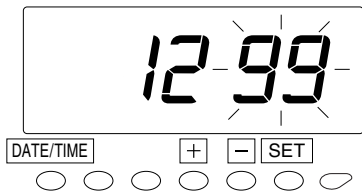

- 2 In case of the example, push the [+] or [-] button to set at "12" and then, push the [SET] button. At that moment, flashing of the display will change to the last two digits.

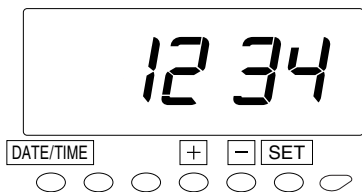

- 3 In case of the example, push the [+] or [-] button to set at "34" and then, push the [SET] button. At that moment, the "▲" mark is located under "DISPLAY HOURS".

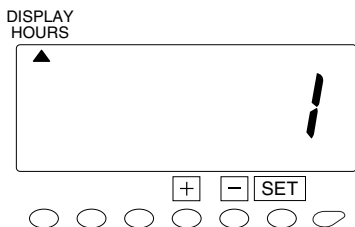

- 4 Select desired setting mode by pressing the [DATE/TIME] button. Then make any changes to setting as explained.

Canceling the Password

The code "0000" must be entered to cancel the password.

Push the [SETTING START/END] button before you start setting. At that moment, "----" is indicated on a display and you go into setting mode.

Example The current password is "1234" and cancel it.

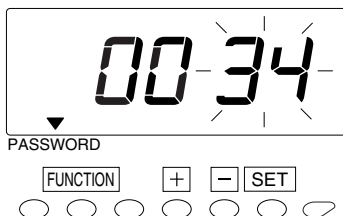
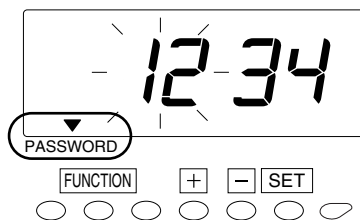
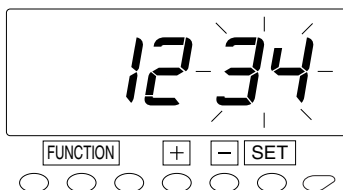
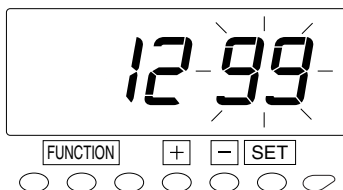
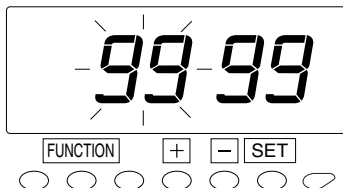

- 1 Push the [FUNCTION] button for two seconds. Then, "9999" will be indicated on the display and the first two digits flash.

A flashing number can be changed.

In case of the example, push the [+] or [-] button to set at "12" and then, push the [SET] button. At that moment, flashing of the display will change to the last two digits.

- 2 In case of the example, push the [+] or [-] button to set at "34" and then, push the [SET] button. At that moment, the "▲" mark is located under "PAY PERIOD".

- 3 Position the "▲" mark over the "PASSWORD" mark by pressing the [FUNCTION] button. At that moment, the first two digits "12" flash.

A flashing number can be changed.

- 4 Push the [+] or [-] button to set at "00" and then, push the [SET] button. At that moment, the flashing of the display will change to the last two digits "34".

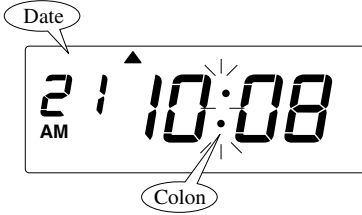
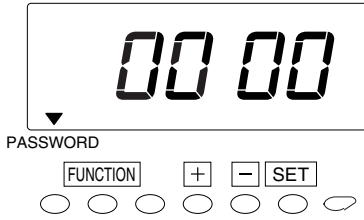

5 Push the [+] or [-] button to set at "00" and then, push the [SET] button. At that moment, the display will change from flashing to steady, and the setting is now completed.

6 Push the [SETTING START/END] button to get out of setting mode. Make sure "date" and "time" are indicated on the display and the colon is flashing. Then replace the cover and lock.

5. Printing Hours Summary

With this function, you can check hours summary per card number and total on card.

You can select "hours summary" for either the active time cards in use or the cards which were already closed in the previous/current period.

Push the [SETTING START/END] button before you start setting. At that moment, "----" is indicated on a display and you go into setting mode.

[For Active Cards]

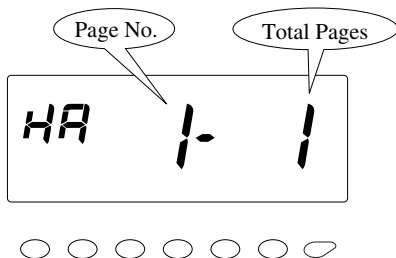

[For Closed Cards]

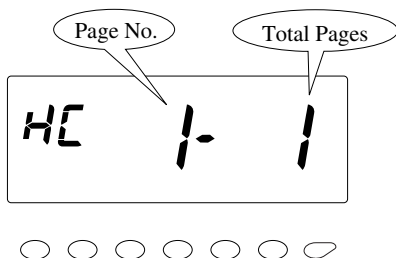

- 1 Push the [HOURS SUMMARY] button for two seconds. At that moment, "HA" is indicated on the left side of the display. When it's indicated on a display, you can print hours summary for active time cards in use. (If you want to have hours summary for the already-closed cards in the previous/current period, push the [HOURS SUMMARY] button again and show "HC" on the display.)

- 2 Insert a blank time card and a list is printed out.

If you want to stop printing, push the [SETTING START/END] button.

- 3 Once list printing is completed, "date" and "time" are indicated on the display and the colon starts flashing. Then replace the cover and lock.

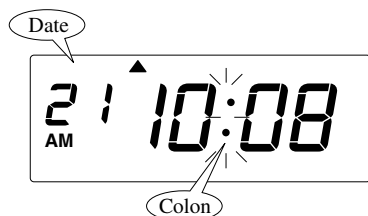

6. Printing List of Active Card Numbers

With this function, you can check what numbers of time cards are used in the current pay period.

Push the [SETTING START/END] button before you start setting. At that moment, "----" is indicated on a display and you go into setting mode.

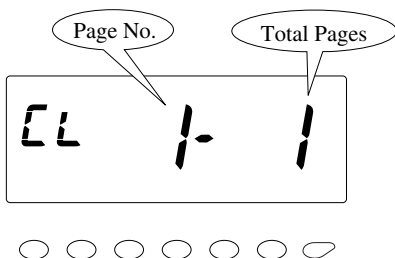

1 Push the [ACTIVE CARD NO.] button for two seconds. At that moment, "CL" is indicated on the left side of the display.

2 Insert a blank time card and a list is printed out.

If you want to stop printing, push the [SETTING START/END] button.

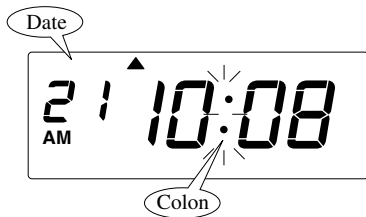

3 Once list printing is completed, "date" and "time" are indicated on the display and the colon starts flashing. Then replace the cover and lock.

7. Printing List of Program Settings

With this function, you can check what rules are currently set in the clock.

Push the [SETTING START/END] button before you start setting. At that moment, " - - - - " is indicated on a display and you go into setting mode.

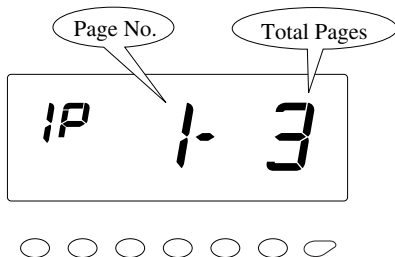

1 Push the [SETTING INFO.] button for two seconds. At that moment, "IP" is indicated on the left side of the display.

2 Insert a blank time card and a list is printed out.

If you want to stop printing, push the [SETTING START/END] button.

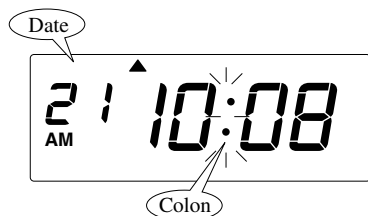

3 Once list printing is completed, "date" and "time" are indicated on the display and the colon starts flashing. Then replace the cover and lock.

8. Additional Features

Override Printing

When you select "Time Zone" rule for calculation, printing line will change to the next line at the "Day Advance Time". However, "OVERRIDE" function enables the punch out time records to the same line of the previous working day even if exit punch time crosses the "Day Advance Time". It's also applicable for "Free Zone" rule and you can punch out time records even leaving time crosses "limit hours for the OUT punch". This is useful when you want to extend working hours.

This function is available only when the "OVERRIDE" is permitted.

Example

IN punch - already printed at 8:15 a.m. on Oct. 20, 2004

OUT punch - to be printed on the same line at 1:50 a.m. on Oct. 21, 2004

- 1 Push the "OVR." button, and then the "OVR." button blinks.

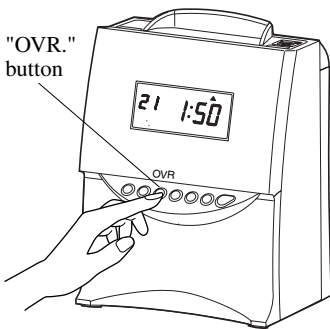

- 2 Insert a time card.

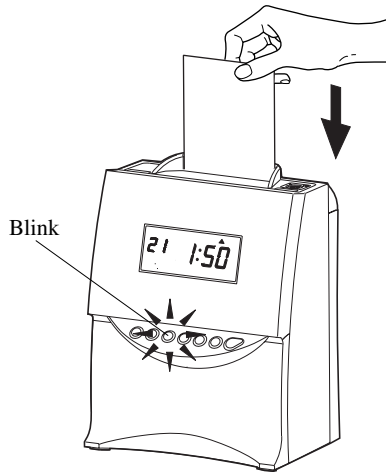

- 3 The OUT punch is printed on the same line.

Even if you use "OVERRIDE" function, you can't exceed the limit of 48 hours from IN punch to OUT punch.

		Daily		Total	
IN	OUT	RH	OT	RH	OT
Au Mo 9:00A	Mo 5:00P	8:00		8:00	
Tu 9:00A	Tu 5:00P	8:00		16:00	
We 9:00A	Th 1:00 	16:00		32:00	

Override

Card Transfer

When the card that you are using becomes full before reaching the "Pay Period" day, it will show "END" on the display and the buzzer will sound. When the "END" appears, you can use the "Card Number Transfer" mode to transfer the card and have a new card take over from the old one.

In this function, it will be useful.....

- when the card has become full before reaching the "Pay Period".
- when the card that is being used is lost, or unable to function because of stain.
- if you want to change the card to a new one.

Example

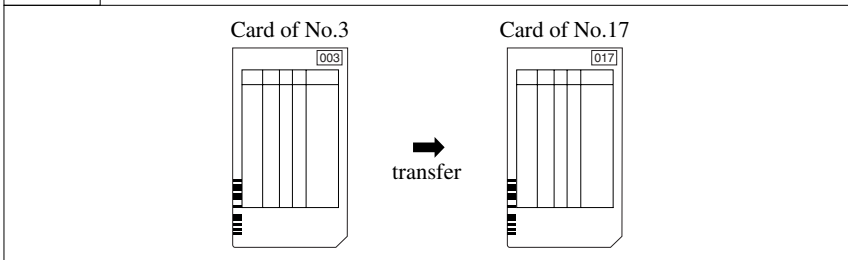

Employee's Operation

This function is available only when the "CARD TRANSFER" is enabled.

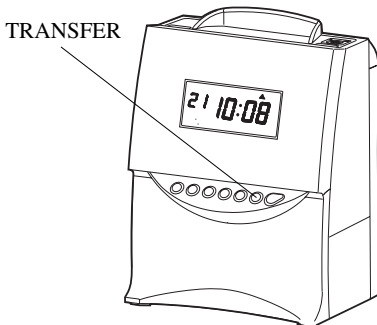

- 1** Push the "TRANSFER" button and insert the card "003".
- 2** Once the card is ejected, insert a new card with the same number (or one of the numbers which isn't registered yet). In case of the example, insert the card "017".

3 "Date/time", "TRANSFER (in the selected language)", and "the previous card No. to a new card No." are printed on the new card and the calculation data (total) of the previous card will be transferred.

4 Now the setting of card number transfer is completed.

Supervisor's Operation

In this mode, you can transfer the card numbers by pushing buttons as well as inserting time cards.

- 1 Open the front cover and push the "SETTING START/END" button. At that moment, "----" is indicated on a display.

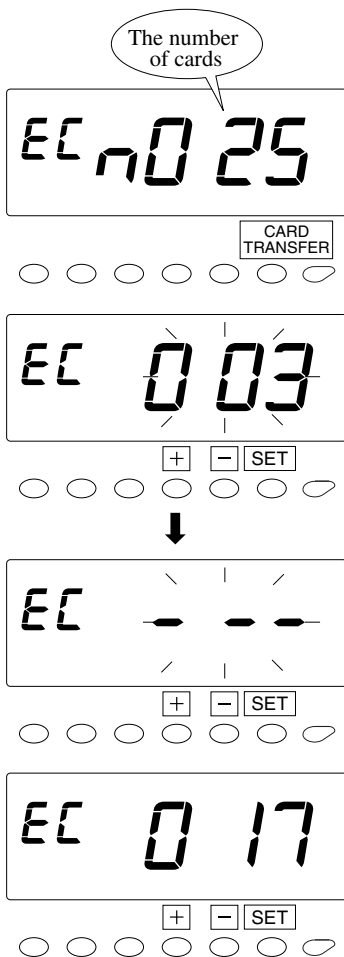

- 2 Push the "CARD TRANSFER" button for two seconds. When you have a card that you are using, the number of cards that you are using will be shown on the display. If there are no cards used at the present state, it will show "n0 00" and will end the mode.
- 3 After the numbers of cards are shown, in the example, push the [+] or [-] button to show the card number "003" and then push the [SET] button. (Or insert the card "003".)
- 4 Push the [+] or [-] button to pick a new card number "017" and then push the [SET] button. (Or insert the card "017".)
- 5 Now calculation data (total) of the previous card has been transferred. Note: When you transfer data by inserting a card, "Date/time", "TRANSFER (in the selected language)", and "the previous card No. to a new card No." are printed on the new card.
- 6 When the card number is changed, this mode will finish.

Card Resetting

When you want to reset the card manually before reaching the "Pay Period" day, you can go into the "Card Resetting" mode.

Example The number of the card you want to reset is "003".

Push the [SETTING START/END] button before you start setting. At that moment, " - - - - " is indicated on a display and you go into setting mode.

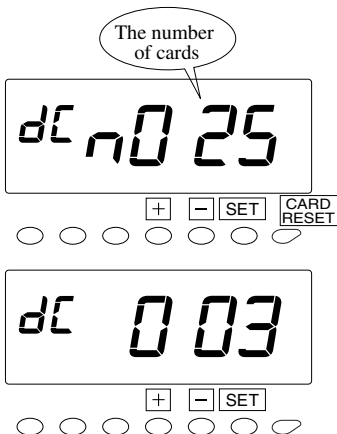

- 1 Push the [CARD RESET] button for 2 seconds. Then, the number of cards that you are using will be shown on the display.
- 2 Select the desired card number by pushing the [+] or [-] button. In case of the example, push [+] button to set at "03" and then, push the [SET] button. At that moment, the display will change from flashing to steady, and push the [SET] button once more.
- 3 Now the setting is completed. Make sure "date" and "time" are indicated on the display and the colon is flashing. Then replace the cover and lock.

All Cards Resetting

When you want to reset all cards manually.....

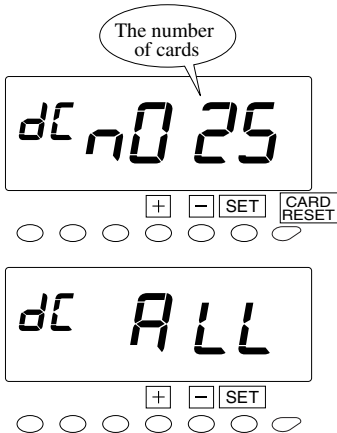

- 1 Refer to the Step 1 in "Card Resetting".
- 2 Push the [+] or [-] button to show "ALL" and then push the [SET] button. At that moment, the display will change from flashing to steady, and push the [SET] button once again.
- 3 Now the setting is completed. Make sure "date" and "time" are indicated on the display and the colon is flashing. Then replace the cover and lock.

9. Resetting

To return all settings to their factory defaults.

Please note that all settings will be deleted and will revert to the factory defaults when the reset switch is pushed. To make new settings, please refer to setting section.

Note: Pressing the reset switch does not reset the time cards. Please refer to the All Cards Resetting in the Additional Features section.

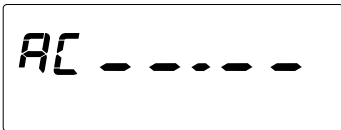
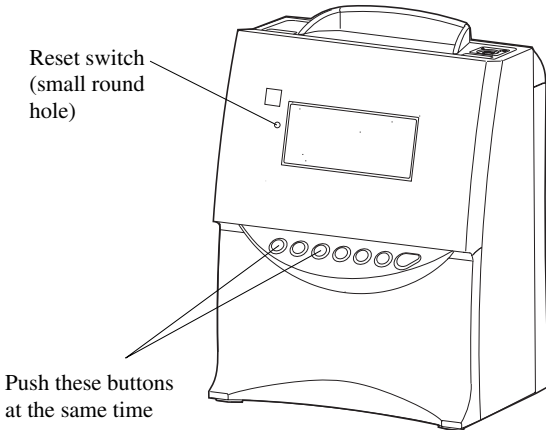

- 1 Unlock and remove cover.
Push the reset switch with a pointed implement while pushing the [DATE/TIME] and [HOURS SUMMARY] button.
- 2 At that moment, the display change to "AC - - - - -".
And after a few seconds, the display changes to date & time "1 12:00 a.m.".

10. Installing the Optional Battery Backup

This option allows for printing without AC power.

Order Acroprint Part Number 58-0108-000, optional battery pack, for this feature.

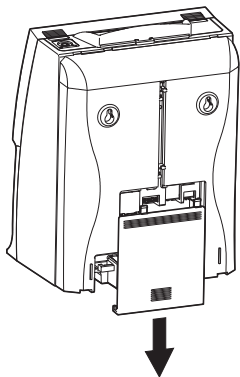

- 1** Remove the cover of the battery compartment on the back of the unit by pushing down the top side of the cover, and then release it from the two clasps.

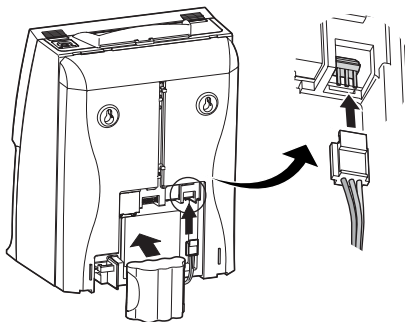

- 2** Position the battery as shown in the figure on the left.
*The connector cord should be on the right side, as shown in the figure.

- 3** Connect the connector. Tuck away the connector cord into the open space in the compartment.

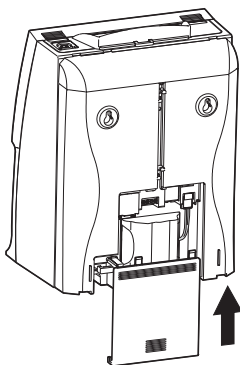

- 4** Insert the cover into the slot as shown on the left. Keep pressing it down until it hooks to the clasp.
Note: Make sure the cord is not caught when closing the cover.

11. Connecting External Signal Control

If external signal(s) are required, the addition of a relay (not supplied) will be necessary. ***Please consult your local electrician.***

When a signal is activated the internal contacts close completing the circuit. These internal contacts are "dry" and supply no voltage. Voltage applied to these contacts must ***not*** exceed 30 volts. An external relay must be used to activate signaling devices.

Recommended Relays: (Or similar line voltage switching relays)

Available at W. W. Grainger

HoneyWell	#RA89A1074	Grainger #2E866
Dayton	#809A-189	Grainger #2E553

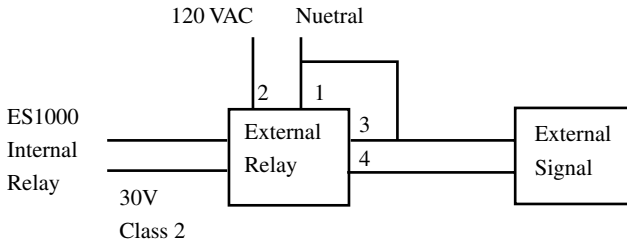

Connections shown for Dayton 2E553. Add jumper from terminals 1 to 3.

CAUTION: Disconnect the ES1000 from the AC Power before connecting the External Signal Relay. Improper connection may cause a malfunction of the unit. Also make sure to secure wires with the wire clamp.

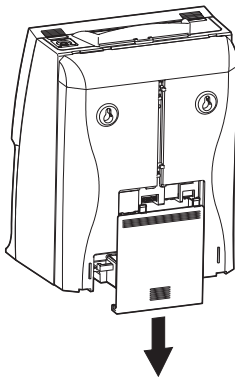

- 1 Remove the cover of the battery compartment on the back of the unit by pushing down the top side of the cover, and then release it from the two clasps.

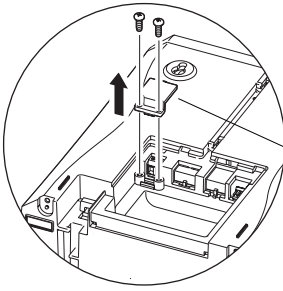

- 2** Remove two screws holding the wire clamp.

Wire clamp

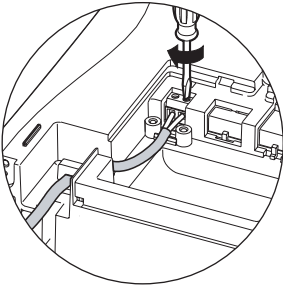

- 3** Insert wires into two terminals for external time signal relay and tighten both screws. Then, tuck away the cord and place it as shown in the figure.

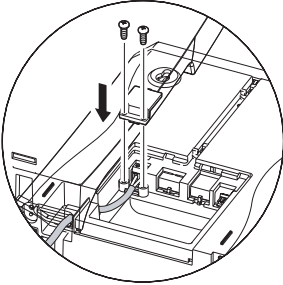

- 4** Secure the wire clamp with screws.

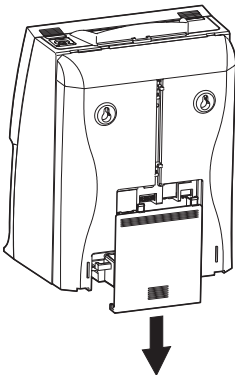

- 5** Insert the cover into the slot as shown on the left. Keep pressing it down until it hooks to the clasp.

Note: Make sure the cord is not caught when closing the cover.

12. Troubleshooting

Error No. appears

No.	Error contents	Action
E-00	CPU error	Contact the store from whom you bought the unit.
E-01	The remaining life of lithium battery for memory back-up is short.	
E-03	The front and back of the time card inserted is wrong.	Correctly insert the time card.
E-05	The card is not pulled in properly.	Make sure that the time card is not bended and another time card is not jamming in the time recorder. After making sure of the above, close the cover.
E-10	Can't save information of time cards.	Open and close the cover once to see if the unit returns to work properly. Then, try to print once again.
E-15	Card sensor error	Make sure that another time card is not jamming in the time recorder and the ribbon cassette is correctly inserted in place.
E-30	The printer motor or the sensor is not normal.	After making sure of the above, close the cover.
E-33	Can't change printing color correctly.	Make sure that the ribbon cassette is correctly inserted in place. After making sure of the above, close the cover.
E-37	The card forwarding motor or the sensor does not operate properly.	Make sure that another time card is not jamming in the time recorder and the ribbon cassette is correctly inserted in place. After making sure of the above, close the cover.
E-38	The print head motor or the sensor for the printer head can not operate properly.	
E-40	Password error	Input the correct password you set. (4-digit numbers)
E-41	The start and end dates of the daylight saving time are the same date.	Correctly set the daylight saving time.
E-49	Input the wrong figures.	Check the setting contents and input the correct figures.
E-50	Can't use the time card.	Check the bar code area whether it is smudged or damaged.
E-51	Print error	Check whether the time was turned back or not. Also check whether the card was inserted within 1 minute after the last punch.
E-53	Failed in registering a time card.	Register the time card once again.
E-59	Can't use the time cards because of memory error.	Use the "Card Reset" function to reset the card. Make sure if you can print by inserting the time card with the same number.
END	When the card that you are using becomes full before reaching the closing day/date.	Use the "Card Number Transfer" function to transfer the card and have a new card take over for the old one.

***If the error number is still displayed after checking above points, contact the store from whom you bought the unit.**

13. Specifications

Clock Accuracy	Monthly accuracy \pm 15 sec. (at ordinary temperatures)
Calendar	Year up to 2099. Automatically adjusted to leap years, 31-day months and months with thirty or fewer days, and the days of the week.
Printing System	Dot matrix
Power failure compensation	Three years of cumulative power failure hours after the date of shipment
Print at power failure	Optional Ni-Cd battery, 100-time printing or 24 hours Acroprint part number 58-0108-000
Lithium battery	CR2450THC
Time cards	Acroprint time card (Form No. ES1010)
Time Program	External time signal (External Alarm device: No voltage signal output)
Operating Environment	Temperature: -5°C to $+45^{\circ}\text{C}$, $+23^{\circ}\text{F}$ to $+113^{\circ}\text{F}$ Humidity: 20 to 80%, no condensation The unit operates normally at temperatures of 5°C or below, but the print density, reaction of the liquid crystal display, and the number of prints at power failure are inferior to those at normal temperature operation.
Dimensions	7.17" (w) x 5.51" (d) x 9.53" (h) 182 (w) x 140 (d) x 242 (h) mm
Weight	Approx. 4.9 lbs. (2.2 kg)
Rating	120VAC 50/60Hz 0.4A



5640 Departure Drive
Raleigh, North Carolina 27616 USA
(919) 872-5800
In USA (800) 334-7190
Fax: (919) 850-0720
www.acroprint.com

Q0170-6120-1
P/N 06-0331-000 Rev. A