

SwitchLinc™ Dimmer High Wattage
INSTEON® Dual-Band Remote Control Dimmer
Owner's Manual (rev 7.0+)
(#2477DHxxx)



I
N
S
T
E
O
N®

The Basics	3
Cautions and Warnings	3
Identifying the Electrical Wires in Your Home	3
Installation	3
Installation – Circuit with 1 Switch (a.k.a. 2-way circuit)	3
Installation – Circuit with 2 Switches (a.k.a. 3-way circuit)	4
Installation – Circuit with 3 (or more) Switches	5
Local Control	6
INSTEON Setup	7
INSTEON Controllers, Responders and Links	7
Make SwitchLinc a Responder	7
Make SwitchLinc a Controller	8
Groups	8
Scenes	8
Remove SwitchLinc as a Controller (Unlink)	9
Remove SwitchLinc as a Responder (Unlink)	9
Change Paddle or LED Color	9
Using Air Gap	9
Factory Reset	9
X10 Setup	10
Add X10 Address	10
Remove X10 Address	10
Other X10 Setup	10
Local Settings	10
Local On-Level	10
Local Ramp Rate	11
Change LED Brightness (or turn it off)	11
Beep on Button Press	11
Error Blink	12
Specifications	12
Troubleshooting	13
Certification and Warranty	15
Certification	15
FCC and Industry Canada Compliance Statement	15
ETL/UL Warning (Safety Warning)	15
Limited Warranty	15
Limitations	15

The Basics

In the Box	Tools Needed	Optional Accessories
SwitchLinc Dimmer High Wattage	Flathead and Phillips screwdrivers	INSTEON app
Quick Start Guide	Wire cutter/stripper	SmartLinc Hub
2 screws and 4 wire nuts	Voltage meter	

Cautions and Warnings

Read and understand these instructions before installing and retain them for future reference.

This product is intended for installation in accordance with the National Electric Code and local regulations in the United States or the Canadian Electrical Code and local regulations in Canada. Use indoors only. This product is not designed or approved for use on power lines other than 120V 60Hz, single phase. Attempting to use this product on non-approved power lines may have hazardous consequences.

Recommended installation practices:

- Use only indoors or in an outdoor rated box.
- Be sure that you have turned off the circuit breaker or removed the fuse for the circuit you are installing this product into. Installing this product with the power on will expose you to dangerous voltages.
- Connect using only copper or copper-clad wire.
- This product may feel warm during operation. The amount of heat generated is within approved limits and poses no hazards. To minimize heat buildup, ensure the area surrounding the rear of this product is as clear of clutter as possible.
- Each INSTEON product is assigned a unique INSTEON I.D., which is printed on the product's label.
- To reduce the risk of overheating and possible damage to other equipment, do not use this product to control Loads in excess of the specified maximum(s) or, install in locations with electricity specifications which are outside of the product's specifications. If this device supports dimming, please note that dimming an inductive Load, such as a fan or transformer, could cause damage to the dimmer, the load-bearing device or both. If the manufacturer of the load device does not recommend dimming, use a non-dimming INSTEON on/off switch. **USER ASSUMES ALL RISKS ASSOCIATED WITH DIMMING AN INDUCTIVE LOAD.**

Identifying the Electrical Wires in Your Home

- Line – carries 120VAC electricity into the wall box, may also be called hot, live or power, commonly black
- Neutral – returns 120VAC to power company, commonly white and in a multi-wire bundle
- Load – connects to light/load device, commonly black and in a separate cable jacket
- Ground – connection to electrical ground, commonly a bare wire, a green wire or a screw on a metal box

IMPORTANT!

If you have any difficulties or questions, consult an electrician. If you are not knowledgeable about and comfortable with electrical circuitry, have a qualified electrician install the product for you.

Installation

Installation – Circuit with 1 Switch (a.k.a. 2-way circuit)

- 1) At electrical panel, turn off circuit breaker(s) and/or remove fuse(s) feeding wall box. Verify that the power is off before continuing.
- 2) Remove wallplate from the switch. Unscrew switch and gently pull out.
- 3) Disconnect wires from switch¹
- 4) Turn on power
- 5) Use a voltage meter to identify the line and load wires connected to the switch
- 6) Identify neutral and ground wires

SwitchLinc Wire	Wall Box Wires
Bare copper	Ground (commonly bare copper, green wire or green screw)
White	Neutral (commonly white)
Red	Load (connected to light)
Black	Line (120V to Ground)

¹ If the wires cannot be detached by unscrewing them, cut the wires where they enter the switch, then strip ½" of insulation off the ends

- 7) Turn off power
- 8) Connect wires as per table/diagram (confirm firm attachments with no exposed wire)

If you are installing SwitchLinc in a multi-gang box next to another switch, you may need to remove one or both pairs of metal heatsink tabs on the back of SwitchLinc. Note that removing a pair of tabs will derate SwitchLinc from 1000W to 800W (one pair removed) or 600W (both pairs removed).
- 9) With LEDs on left, gently place SwitchLinc into wall box and screw into place
- 10) Turn on power

SwitchLinc and its connected load will turn on
- 11) Verify SwitchLinc is working properly by tapping SwitchLinc on and off

SwitchLinc and its connected load will turn on and off
- 12) Reinstall the wallplate

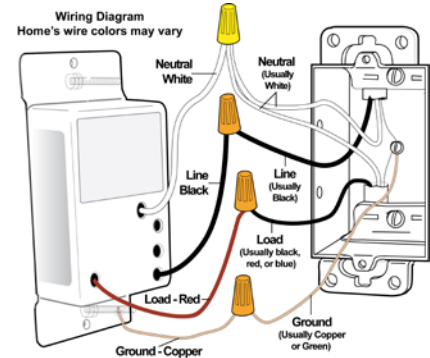

Installation – Circuit with 2 Switches (a.k.a. 3-way circuit)

Circuits with 2 switches are called 3-way circuits. Both switches in a 3-way circuit need to be replaced by SwitchLincs (and/or other INSTEON devices).

- 1) Turn off circuit breaker(s) and/or remove fuse(s) feeding wall boxes (verify that power is off)
- 2) Pull both switches from their wall boxes (each switch will have no less than 3 wires)
- 3) Remove wires from existing switches
- 4) Make sure wires are safely separated from each other and turn power back on
- 5) Using a voltage meter measure each wire to ground in both boxes until you find the single wire supplying 120V (line)
 - a. We will now refer to that location as Box 1
 - b. The other box will have the load wire. That will be Box 2
- 6) Turn power back off

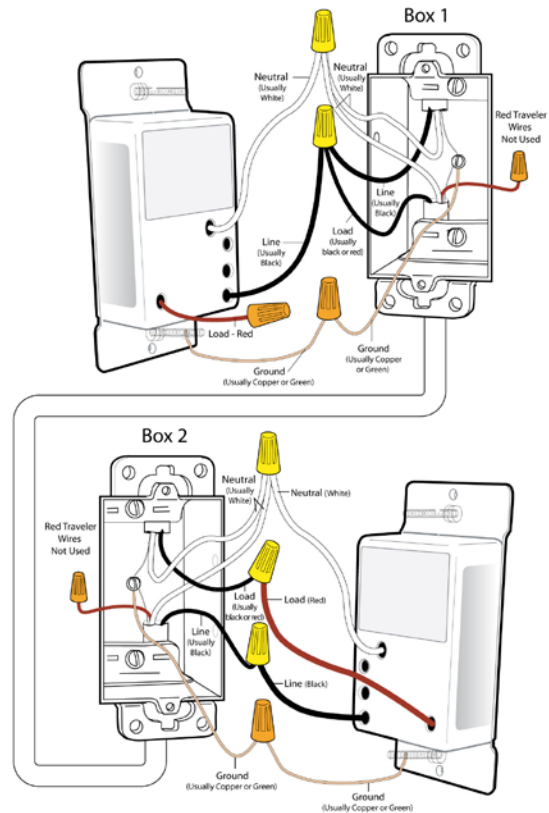

In Box 1 (Line box)

- 7) Connect bare SwitchLinc ground to bare ground wire or ground screw in wall box
- 8) Connect SwitchLinc white wire to neutral wire(s) in wall box (usually white)
- 9) Using a wire nut, cap SwitchLinc red wire.
- 10) Connect SwitchLinc black wire to Line wire in wall box (usually black) along with one traveler wire running between boxes. (preferably black) Note color of this traveler – it will carry 120V/line voltage to Box 2.
- 11) Cap unused traveler

In Box 2 (Load box)

- 12) Connect SwitchLinc bare wire to bare ground wire or ground screw in wall box

- 13) Connect SwitchLinc white wire to neutral wire(s) in wall box (usually white)
- 14) Connect SwitchLinc red wire to load wire
- 15) Connect SwitchLinc black wire to same color traveler from Box 1 carrying Line (usually black)
- 16) Cap unused traveler wire
- 17) With LEDs on left, gently place SwitchLincs into their wall boxes and screw in place
- 18) Turn power back on
SwitchLincs and connected load will turn on (only SwitchLinc in Box 2 will operate load)
- 19) Add both SwitchLincs to a group. See "Groups"
- 20) Verify both SwitchLincs are working properly by tapping on and off on each SwitchLinc
Both SwitchLincs and the connected load will remain in synch
- 21) Reinstall wallplates

Installation – Circuit with 3 (or more) Switches

Circuits with 3 or more switches are called 4-way (or 5-way, etc.) All switches in 3-way/4-way circuits need to be replaced by INSTEON devices.

- 1) Turn off circuit breaker(s) and/or remove fuse(s) feeding wall boxes (verify that power is off)
- 2) Pull all three switches from their wall boxes (4-way (and higher) switches have 3 or 4 wires)
- 3) Remove wires from existing switches
- 4) Make sure wires are safely separated from each other and turn power back on
- 5) Using a voltage meter measure each wire to ground in all three boxes until you find the single wire supplying 120V (line)
 - a. We will now refer to that location as Box 1
 - b. The location having 2 sets of matching pairs of wires will be Box 2 (i.e. 2 reds and 2 blacks, or other matching colors). These are 2 travelers from Box 1 and 2 travelers leading to Box 3
 - c. The last box will have the load wire. That will be Box 3
- 6) Turn power back off

In Box 1 (Line box)

- 7) Connect SwitchLinc bare wire to ground
- 8) Connect SwitchLinc white wire to neutral
- 9) Cap SwitchLinc red wire
- 10) Connect SwitchLinc black wire to line plus one traveler (preferably black) and note color of traveler you are using as this will carry line voltage to Box 2
- 11) Cap unused traveler wire

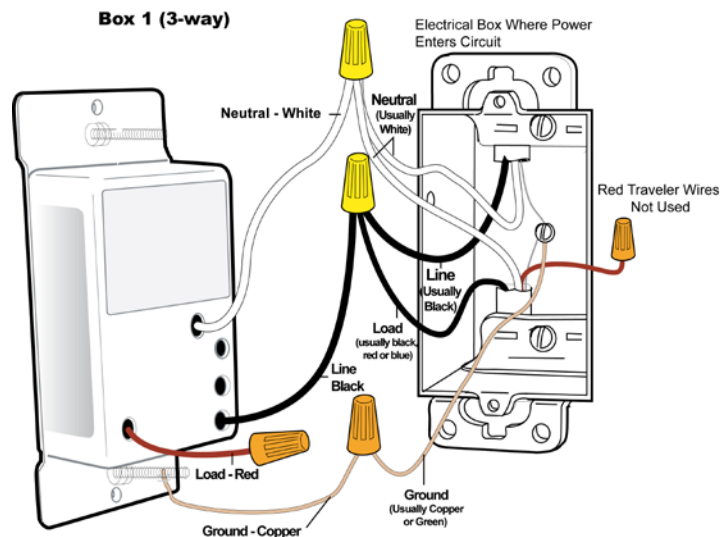

In Box 2 (Traveler box)

- 12) Connect SwitchLinc bare wire to ground
- 13) Connect SwitchLinc white wire to neutral¹
- 14) Cap SwitchLinc red wire
- 15) Connect SwitchLinc black wire to same color traveler from Box 1 that you connected to line along with same color traveler wires leading to Box 3
- 16) Cap the last unused traveler wire(s)

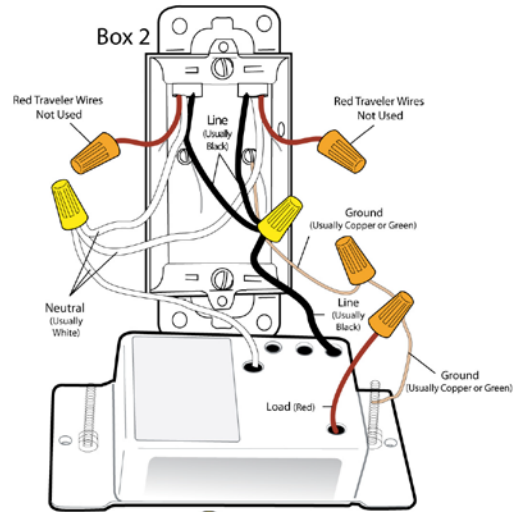

In Box 3 (Load box)

- 17) Connect SwitchLinc bare wire to ground
- 18) Connect SwitchLinc white wire to neutral
- 19) Connect SwitchLinc red wire to load
- 20) Connect SwitchLinc black wire to line traveler from Box 2 (Line traveled from Box 1 through 2 into 3 usually black)
- 21) Cap unused traveler wire
- 22) With LEDs on left, gently place SwitchLincs into wall boxes and screw in place
- 23) Turn power back on

SwitchLincs and connected load will turn on

- 24) Add all SwitchLincs to a group. See "Groups"
- 22) Verify all SwitchLincs are working properly by tapping each on and off

All SwitchLincs and the connected load will remain in synch

- 25) Reinstall wallplates

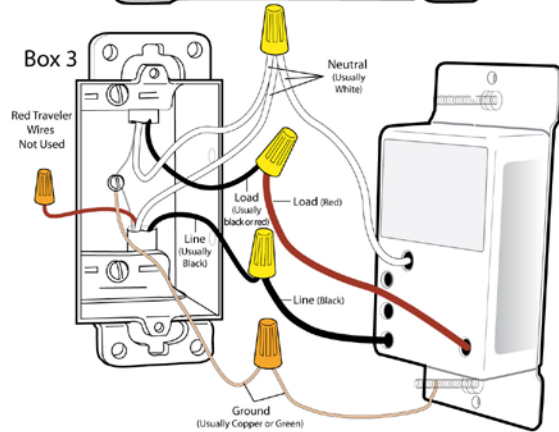

Local Control

Follow these instructions to control the connected light/load (as well as any responders) from the SwitchLinc paddle.

Connected Light (and Responders)			
Paddle	Tap	Press and hold	Double-tap
Top	On (ramped)	Brighten (until release)	On (instant)
Bottom	Off (ramped)	Dim (until release)	Off (instant)



Tap for ON, press and hold to brighten

Tap for OFF, press and hold to dim

¹ If neutral is not available in this box; use other unused traveler from Box 1 to carry neutral to Box 2. Label and mark any differently colored wire being connected to neutral with a piece of white tape to flag it as neutral.

INSTEON Setup

Some products have subtle differences in their setup procedures. Where necessary, please refer to the other device's owner's manual for details.

INSTEON Controllers, Responders and Links

Let's define a few terms.

- Each INSTEON compatible product is called a **device**
- The INSTEON "transmitter" is called a **controller**
- The INSTEON "receiver" is called a **responder**
- The association between the controller and responder is called a **link**
- When a controller simultaneously controls multiple responders, it is called a **scene**
- When all members of a scene are synchronized (always go on and off together), it is called a **group**

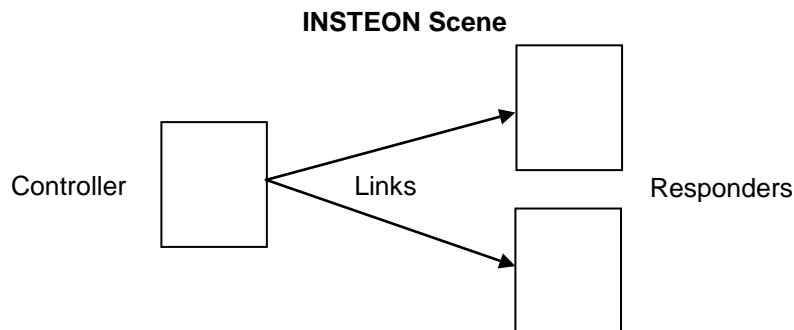
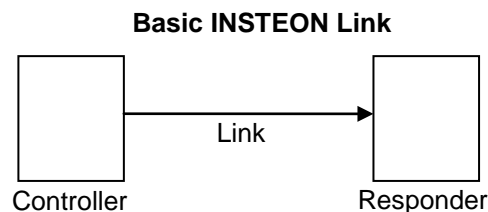

Note that a link is one way. If you wish to have control "the other way," simply add a link "the other way."

Make SwitchLinc a Responder

- 1) Press and hold controller button until it beeps
Controller LED will start blinking
- 2) Adjust SwitchLinc to desired brightness for link/scene¹
- 3) Press and hold SwitchLinc Set button until it double-beeps
Controller LED will stop blinking
- 4) Test by tapping controller button on and off

¹ If the responder is a multi-scene device such as a KeypadLinc, tap the scene button you wish to control until its LED is in the desired scene state (on or off). You can program any state, not just on, for the responder's link.

SwitchLinc will turn on (at desired brightness) and off

Make SwitchLinc a Controller

- 1) Press and hold SwitchLinc Set button until it beeps
LED will start blinking green
- 2) Adjust responder to desired brightness/state
- 3) Press and hold responder Set button until it double-beeps
SwitchLinc will double-beep and its LED will stop blinking
- 4) Test by tapping SwitchLinc paddle on and off
Responder will turn on (at desired brightness) and off
- 5) To add more responders, repeat steps 1-4 for each responder

Groups

Devices in a group remain synchronized. Every device in a group is both a controller of and a responder to all the other devices. The most common example of a group is a circuit with 2 switches (referred to as a 3-way circuit).

Example group for a 'virtual' 3-way circuit with SwitchLinc "A" and SwitchLinc "B":

- 1) Turn A and B on
- 2) Press and hold A Set button until it beeps
A LED will start blinking green
- 3) Press and hold B Set button until it double-beeps
A will double-beep and its LED will stop blinking (A is now a controller of B.
- 4) Press and hold B Set button until it beeps
B LED will start blinking green
- 5) Press and hold A Set button until it double-beeps
*B will double-beep and its LED will stop blinking (B is now a controller of A)
A and B are now grouped*
- 6) Test by turning load on and off from A and then B
The load(s) and both A and B LEDs will remain in sync

Scenes

Scenes feature multiple responders, each with its own unique individual settings, activated from a single controller. Responders in a scene can each have different settings. This provides for advanced lighting, audio, etc. in scene creation. Home management software such as HouseLinc is recommended for scene management.

Example scene with one controller and SwitchLinc as a responder, plus other responders:

- 1) Press and hold controller button until it beeps
Controller LED will start blinking
- 2) Tap controller Set button
Controller LED will start double-blinking
- 3) Adjust SwitchLinc to desired brightness for scene¹
- 4) Press and hold SwitchLinc Set button until it double-beeps
- 5) For each additional scene member:
 - a. Adjust member to desired scene brightness (or state if not a lighting device).
 - b. Press and hold member Set button until it double-beeps.
- 6) Press and hold controller Set button until it double-beeps
Controller LED will stop blinking

¹ If the responder is a multi-scene device such as a KeypadLinc, tap the scene button you wish to control until its LED is in the desired scene state (on or off). You can program any state, not just on, for the responder's link.

- 7) Test by tapping controller button on and off
SwitchLinc and all scene responders will turn on (to desired brightness/states) and off

Remove SwitchLinc as a Controller (Unlink)

- 1) Press and hold SwitchLinc Set button until it beeps
LED will start blinking green
- 2) Press and hold SwitchLinc Set button until it beeps
LED will start blinking red
- 3) Press and hold responder Set button until it double-beeps
SwitchLinc will double-beep and its LED will stop blinking
- 4) Test by tapping SwitchLinc on and off
Former responder will not respond

Remove SwitchLinc as a Responder (Unlink)

If you no longer want a controller button to control SwitchLinc follow these directions. Important: perform these steps for all controllers of SwitchLinc before removing SwitchLinc from use. Otherwise, controllers will retry commands repetitively, creating network delays.

- 1) Press and hold controller button until it beeps
Controller LED will start blinking
- 2) Press and hold controller button until it beeps
Controller LED will continue blinking
- 3) Press and hold SwitchLinc Set button until it double-beeps
Controller LED will stop blinking
- 4) Test by tapping controller button on and off
SwitchLinc will no longer respond

Change Paddle or LED Colors

You can swap out the included white LEDs and/or front paddle and trim frame assembly with a color-change kit before or after SwitchLinc is installed. For more information, see the [Accessories page on INSTEON.com](#).

Using Air Gap

Anytime you want SwitchLinc's controlled load to be unpowered but don't want to turn off the circuit breaker—such as when replacing light bulbs—use the air gap to quickly and conveniently disable power to the connected load.

Using your fingernail or a small flathead screwdriver, pull out SwitchLinc Set button as far as it will go (about 1/8"). This opens the mechanical contacts and removes all power from the SwitchLinc and its load. (Because SwitchLinc's settings are stored in its non-volatile memory, your setup information will not be lost.) To re-enable power to SwitchLinc, simply push in the Set button until it is flush with the trim frame.

Factory Reset

All settings and scenes will be erased.

- 1) Pull out SwitchLinc Set button to remove power
- 2) Wait 5 seconds
- 3) Push in Set button and hold it. Do not let go
SwitchLinc will emit a long beep

- 4) When long beep stops, release Set button
 - A few seconds will pass*
 - SwitchLinc will double-beep*
 - The connected load will turn on*

X10 Setup

SwitchLinc ships with no X10 address assigned.

Add X10 Address

- 1) Turn SwitchLinc on.
- 2) Press and hold Set button until it beeps.
 - LED will start blinking green*
- 3) Send the X10 address 3 times (with or without commands)
 - SwitchLinc will double-beep and LED will stop blinking*
- 4) Test by sending X10 on and off commands
 - SwitchLinc will turn on and off*

Remove X10 Address

- 1) Press and hold Set button until it beeps
 - LED will start blinking green*
- 2) Press and hold Set button until it beeps
 - LED will start blinking red*
- 3) Send the X10 address 3 times (with or without commands)
 - SwitchLinc will double-beep and LED will stop blinking*
- 5) Test by sending X10 on and off commands
 - SwitchLinc will no longer respond*

Other X10 Setup

For other X10 setup instructions visit <http://www.smarthome.com/insteon-x10-programming.html>

Local Settings

Local On-Level

Default = 100% (fixed brightness) The local on-level is the brightness that SwitchLinc's connected load will come on when turned on at SwitchLinc paddle. Local on-level can be set to any one of 32 fixed brightness levels (3% to 100%) or "resume bright" (brightness prior to last being turned off).

To set local on-level to a fixed brightness level

- 1) Adjust SwitchLinc to desired brightness when controlled locally
- 2) Tap Set button
 - SwitchLinc will beep*
- 3) Test by turning SwitchLinc off and then back on (via the paddle)
 - SwitchLinc will turn on to new local on-level*

To set local on-level to the brightness level prior to being turned off

- 1) Turn SwitchLinc off

- 2) Tap Set button
SwitchLinc will beep
- 3) Test:
 - a. Brighten SwitchLinc to a random brightness level (e.g. 75%)
 - b. Turn SwitchLinc off
 - c. Turn SwitchLinc back on
Light will turn on at the defined brightness level

Local Ramp Rate

Default = ½ second. The local ramp rate is the time it takes for SwitchLinc to reach 100% brightness (from off) when controlled at the paddle. It is adjustable from instant to 8 minutes (with software) and instant to 5 seconds (using Set button).

- 1) Adjust SwitchLinc brightness corresponding to the desired local ramp rate in the table below
Hint: dim momentarily from 100% for 0.5 seconds or brighten momentarily from off for 2.0 seconds

Brightness	Ramp Rate
100%	Instant
51-99%	½ second
01-50%	2 seconds
Off	5 seconds

- 2) Double-tap Set button
SwitchLinc will beep
- 3) Test by turning off and then back on via the local switch
Light will ramp off and back on at the new local ramp rate
Note: if SwitchLinc recognized two single taps it will have adjusted the local on-level instead of the local ramp rate. Return to step 1 and try again

Change LED Brightness (or turn it off)

Default = 50% bright.

- 1) Press and hold Set button until it beeps
LED will start blinking green
- 2) Press and hold Set button until it beeps
LED will start blinking red
- 3) Press and hold Set button until it beeps
LED will stop blinking
- 4) Use SwitchLinc on and/or off buttons to brighten or dim LEDs to desired level
- 5) Tap Set button
SwitchLinc will double beep and return to ready mode

Beep on Button Press

Default = off. This setting is adjustable via software or a central controller only.

Error Blink

Default = on. This setting is adjustable via software or a central controller only. SwitchLinc LED blinks for a few seconds if one or more responders do not acknowledge a message.

Specifications

General		
Product name	SwitchLinc Dimmer High Wattage	
Brand	INSTEON	
Manufacturer product number	2477DHxx	
UPC	White – 2477DHWH: 813922011005 Almond – 2477DHAL Ivory – 2477DHIV	
Warranty	2 years, limited	
INSTEON		
INSTEON powerline mesh repeater	Yes	
INSTEON RF mesh repeater	Yes	
INSTEON controller	Yes	
INSTEON responder	Yes	
Maximum links/scenes	400	
Load brightness levels	32 (256 when controlled by software)	
Brightness of LEDs	Adjustable, from off to 100% bright	
Local on-level	4 locally, increments of 1% with software	
Local ramp-rate	0.1 seconds to 2 seconds (0.125 seconds to 8 minutes via software)	
Local control	Yes	
Commands supported as controller	On	Off
	Fast on	Fast off
	Brighten	Dim
Commands supported as responder	On	Off
	Fast on	Fast off
	Brighten	Dim
Software configurable	Yes	
RF range	Up to 150' open air	
Phase bridge detect beacon	Yes	
INSTEON device category	0x01 dimmable lighting control (all frequencies)	
INSTEON device subcategory	0x01	0x20
X10		
X10 address	1 optional (comes unassigned)	
X10 transmitter	Yes	
X10 receiver	Yes	

X10 status response	Supported
X10 resume dim	Supported (by setting local on-level to zero)
X10 minimum transmit level	3.2 Vpp into 5 Ohms
X10 minimum receive level	20mV into 5 Ohms
Mechanical	
Mounting	Mounts in single or multiple-ganged junction box. Control 200W less load for each immediately adjacent SwitchLinc Dimmer installed. For example, 600 W load control becomes 400 W with another dimmer to the immediate right or left. Use a triple-gang box with a mechanical switch in the center to avoid de-rating.
Wires	Line (black)
	Load (red)
	Neutral (white)
	Ground (bare copper)
Case color	White
Switch paddle and frame color	White
Set button	Yes
Plastic	UV stabilized polycarbonate
Beeper	Yes
Beep on button press	Optional (off by default)
Status LEDs	1 dual-color red/green and 9 white
Dimensions	4.1" H x 1.8" W x 1.2" D
Weight	3.6 oz. (102 grams)
Operating environment	Indoors
Operating temperature range	32° to 104° F (0° to 40° C)
Operating humidity range	0-85% relative humidity
Storage temperature range	-4° to 158° F (-20° to 70° C)
Electrical	
Voltage	120VAC (+/- 10%), 60 Hz, single phase
Neutral connection required	Yes
Frequency	915 MHz
Load type(s)	Wired-in incandescent lighting fixtures
Maximum load	1000 watts (uses 12 Amp triac dimmer)
User replaceable fuse	No
Hardwired remote control	No
Retains all settings without power	Yes, saved in non-volatile EEPROM
Standby power consumption	0.59 watts
Certifications	FCC, IC Canada
Safety approval(s)	ETL (Intertek Testing Services) to UL/ANSI standard

Troubleshooting

Problem	Possible Cause	Solution
SwitchLinc's LEDs and connected load will not turn on	SwitchLinc is not getting power	Make sure the circuit breaker is turned on
		Check the light fixture to ensure all connections are tight and no bare wires are exposed

The switch I'm replacing only has two wires	SwitchLinc needs a neutral wire in order to operate	If there are white wires in wall box, test them and if they are neutrals use them
		Pull a neutral wire to the wall box
		Purchase the 2-wire SwitchLinc (2474DWH) in place of this SwitchLinc
SwitchLinc is able to communicate with another INSTEON device	SwitchLinc and the other device are out of range	Install more INSTEON products (including, but not limited to Range Extenders/Access Points)
	The other device is near a localized powerline noise source or attenuator	Isolate the noise/attenuator using a FilterLinc
The light turned on by itself	Another controller, a timer or a stray X10 signal was received	Install a powerline signal blocker in your home to keep X10 signals from neighboring homes from interfering. Consider not using SwitchLinc in X10 mode
		If problem persists, perform a factory reset. See Factory Reset
It takes a long time for one or more of SwitchLinc's responders to respond	SwitchLinc is repeatedly retrying to control a missing responder	If the responder is still available, unlink it from SwitchLinc. See Remove SwitchLinc as an INSTEON Responder
		Perform a factory reset. See Factory Reset
The load is buzzing when on or dim	The dimming component inside SwitchLinc "chops" the powerline sine wave to reduce the power	The bulb filaments are vibrating. Use rough-service, 130V or appliance-grade bulbs to reduce the noise
		Run SwitchLinc in "full-on" mode or replace dimmer with and on/off SwitchLinc
SwitchLinc is locked up	A surge or excessive noise on the powerline may have glitched it	Pull the Set button on SwitchLinc all the way out to create an air gap, wait 5 seconds, then push it back in until it's flush with the trim frame (don't push it all the way in)
		If problem persists, perform a factory reset. See Factory Reset
SwitchLinc is getting warm to the touch	It is normal for wall dimmers to feel warm	
SwitchLinc can turn responder off, but not on	Your responder may be linked at off	Relink your responder to SwitchLinc at desired on-level
My controller can turn SwitchLinc off, but not on	SwitchLinc may be linked at its off	Relink SwitchLinc to your controller, while its load is on
SwitchLinc trips the Arc Fault Circuit Interrupter (AFCI)	The AFCI might be too sensitive	Replace your AFCI with a less sensitive brand or model from a hardware store with a customer-friendly return policy. SwitchLinc modules do not trip when used with the vast majority of AFCI models and is known to not trip with the following models: <ul style="list-style-type: none"> • GE 15 Amp Combination Arc Fault Breaker #THQL1115AFP2 • Murray 2-Pole Combination Type Arc Fault Circuit Interrupter #MP215AFCP
	There might be loose connections within your home's wiring	Install a powerline noise filter (such as a FilterLinc) between the output and the lead
The LEDS are too bright (or too dim)		Adjust the LED brightness. See Change LED Brightness

If you have tried these solutions, reviewed this Owner's Manual, and still cannot resolve an issue you are having with SwitchLinc Dimmer High Wattage, please call the INSTEON Support Line at 1-800-762-7845

Certification and Warranty

Certification

This product has been thoroughly tested by ITS ETL SEMKO, a nationally recognized independent third-party testing laboratory. The North American ETL Listed mark signifies that the device has been tested to and has met the requirements of a widely recognized consensus of U.S. and Canadian device safety standards, that the manufacturing site has been audited, and that the manufacturer has agreed to a program of quarterly factory follow-up inspections to verify continued conformance.

FCC and Industry Canada Compliance Statement

This device complies with FCC Rules Part 15 and Industry Canada RSS-210 (Rev. 7). Operation is subject to the following two conditions:

- (1) This device may not cause harmful interference, and
- (2) This device must accept any interference, including interference that may cause undesired operation of the device.

Le present appareil est conforme aux CNR d'Industrie Canada applicables aux appareils radio exempts de licence. L'exploitation est autorise aux deux conditions suivantes:

- (1) l'appareil ne doit pas produire de brouillage, et
- (2) l'utilisateur de l'appareil doit accepter tout brouillage radioelectrique subi, mme si le brouillage est susceptible d'en compromettre le fonctionnement.

The digital circuitry of this device has been tested and found to comply with the limits for a Class B digital device, pursuant to Part 15 of the FCC Rules. These limits are designed to provide reasonable protection against harmful interference in residential installations. This equipment generates, uses, and can radiate radio frequency energy and, if not installed and used in accordance with the instructions, may cause harmful interference to radio and television reception. However, there is no guarantee that interference will not occur in a particular installation. If this device does cause such interference, which can be verified by turning the device off and on, the user is encouraged to eliminate the interference by one or more of the following measures:

- Re-orient or relocate the receiving antenna of the device experiencing the interference
- Increase the distance between this device and the receiver
- Connect the device to an AC outlet on a circuit different from the one that supplies power to the receiver
- Consult the dealer or an experienced radio/TV technician

WARNING: Changes or modifications to this device not expressly approved by the party responsible for compliance could void the user's authority to operate the equipment.

ETL/UL Warning (Safety Warning)

CAUTION: To reduce the risk of overheating and possible damage to other equipment, do not install this device to control a receptacle, a motor-operated appliance, a fluorescent lighting fixture, or a transformer-supplied appliance.

Gradateurs commandant une lampe a filament de tungstene – afin de reduire le risqué de surchauffe et la possibilite d'endommagement a d'autres materiels, ne pas installer pour commander une prise, un appareil a moteur, une lampe fluorescente ou un appareil alimente par un transformateur.

Limited Warranty

Seller warrants to the original consumer purchaser of this product that, for a period of two years from the date of purchase, this product will be free from defects in material and workmanship and will perform in substantial conformity to the description of the product in this Owner's Manual. This warranty shall not apply to defects or errors caused by misuse or neglect. If the product is found to be defective in material or workmanship, or if the product does not perform as warranted above during the warranty period, Seller will either repair it, replace it, or refund the purchase price, at its option, upon receipt of the product at the address below, postage prepaid, with proof of the date of purchase and an explanation of the defect or error. The repair, replacement, or refund that is provided for above shall be the full extent of Seller's liability with respect to this product. For repair or replacement during the warranty period, call the INSTEON Support Line at 800-762-7845 with the Model # and Revision # of the device to receive an RMA# and send the product, along with all other required materials to:

INSTEON
ATTN: Receiving
16542 Millikan Ave.
Irvine, CA 92606-5027

Limitations

The above warranty is in lieu of and Seller disclaims all other warranties, whether oral or written, express or implied, including any warranty or merchantability or fitness for a particular purpose. Any implied warranty, including any warranty of merchantability or fitness for a particular purpose, which may not be disclaimed or supplanted as provided above shall be limited to the two-year of the express warranty above. No other representation or claim of any nature by any person shall be binding upon Seller or modify the terms of the above warranty and disclaimer.

Home automation devices have the risk of failure to operate, incorrect operation, or electrical or mechanical tampering. For optimal use, manually verify the device state. Any home automation device should be viewed as a convenience, but not as a sole method for controlling your home.

In no event shall Seller be liable for special, incidental, consequential, or other damages resulting from possession or use of this device, including without limitation damage to property and, to the extent permitted by law, personal injury, even if Seller knew or should have known of the possibility of such damages. Some states do not allow limitations on how long an implied warranty lasts and/or the exclusion or limitation of damages, in which case the above limitations and/or exclusions may not apply to you. You may also have other legal rights that may vary from state to state.

Protected under U.S. and foreign patents (see www.insteon.com).

© Copyright 2012 INSTEON, 16542 Millikan Ave., Irvine, CA 92606, 800-762-7845, www.insteon.com