

PRODUCT SUPPORT MANUAL

RCL-300A //

Searchlight Remote Control System

Model No.: RCL-300A

Product No.: 1933

Y1-03-0232, Rev. D



ACR Electronics, Inc. // 5757 Ravenswood Road // Fort Lauderdale // FL // 33312-6645
Tel: +1 (954) 981-3333 // Fax: +1 (954) 983-5087 // www.acrelectronics.com

About Cobham Life Support, ACR Products

Cobham Life Support, ACR Products, www.acrelectronics.com, designs and manufactures a complete line of safety and survival products including EPIRBs, PLBs, AIS, SARTs, Strobe Lights, Life Jacket Lights, Search Lights and safety accessories. The quality systems of this facility have been registered by UL to the ISO 9001:2000 Series Standards. Recognized as the world leader in safety and survival technologies, ACR has provided safety equipment to the aviation and marine industries as well as to the military since 1956.

About Cobham plc

Cobham plc is an international company engaged in the development, delivery and support of advanced aerospace and defence systems for land, sea, air and space, The company has four divisions that collectively specialize in the provision of components, subsystems and services that keep people safe, improve communications and enhance the capability of aerospace and defence platforms.



CAUTION: Before proceeding to install, test or use your new ACR Electronics' product, please read this Product Support Manual in its entirety.

If you have questions regarding the contents of the manual, please contact our Technical Service Department at ACR Electronics, Inc., Telephone +1 (954) 981- 3333. Please be ready to provide the technician with the page number you wish to discuss. If you have a question that is not covered in the manual, please visit our website and access the Frequently Asked Questions (FAQs) section for further information or call our Technical Service Department. The website address is www.acrelectronics.com. If in the future you lose this manual, you may access and print a replacement on the ACR website.

Table of Contents

SECTION 1 - PRODUCT DESCRIPTION	3
SECTION 2- SEARCHLIGHT MOUNTING	4
SECTION 3 - REMOTE CONTROL SYSTEM	5
SECTION 4 - URP-102 POINT PAD™	5
SECTION 5 - URC-300 MASTER CONTROLLER	7
SECTION 6 - POINT PAD™ OPERATION	9
APPENDIX A - SPECIFICATIONS	11
APPENDIX B - KIT COMPONENTS	12
APPENDIX C - WIRING DIAGRAM	13
APPENDIX D - WARRANTY, USEFUL LIFE POLICY, NOTICES	14



**PLEASE READ ALL WARNINGS, CAUTIONS
AND NOTES CAREFULLY**

SECTION1 - PRODUCT DESCRIPTION

Introduction

The RCL-300A was specially designed for mariners who require a high intensity remote controlled searchlight that can stand up to the tough marine environment.

The sleek design and modern construction of the searchlight body makes it attractive for recreational and commercial vessels. The searchlight is totally enclosed and is made of rugged aluminum alloy. It is gasketed and finished to be resistant to the weather.

The RCL-300A searchlight contains a narrow beam searchlight that produces 1,000,000 peak candle power by combining twin 35W metal halide HD lamps providing over 500K candela (CD) each and 1 million effective CD when combined.

All functions of the searchlight can be electrically operated by remote control from the pilot area of the vessel using the URP-102 Point Pad™, URC Master Controller and interconnect cable supplied with the RCL-300A. Searchlights equipped with the URC-300 Master Controller have a self-park feature and ACR's unique XRCiZ™ feature. The XRCiZ™ feature routinely operates all moving parts in the searchlight to keep the motors and drive mechanisms freely running.

Unpacking the RCL-300A

Your new RCL-300A Remote Control Searchlight System comes with the following components:

- 1.) RCL-300A searchlight
- 2.) URP-102 Point Pad™ with Installation Kit
- 3.) URC-300 Master Controller with Installation Kit
- 4.) Product Support Manual, Warranty Card, Mounting Templates, etc.
- 5.) Coaxial Cable Kit



Figure 1- RCL-300A Components

SECTION 2- SEARCHLIGHT MOUNTING

Make sure the area is clean and dry. The searchlight can be mounted where desired, using appropriate length 5/16" diameter stainless steel fasteners. One set is provided in the mounting kit and four (4) nylon shoulder washers. The nylon washers prevent a galvanic reaction between the mounting hardware and the base of the searchlight. Be sure these washers have been inserted in the base mounting holes and that the mounting base gasket is securely in place before bolting down. Apply silicone grease to the bottom of the gasket to help in waterproofing the unit. When mounting, be sure the searchlight is able to rotate 360° without hitting any obstructions. For the drilling hole pattern, refer to the searchlight Mounting Template.



CAUTION: Do not mount the searchlight upside down. Moisture cannot drain from the inverted light head assembly.

Self Park Feature

The RCL-300A has a Self-Park feature. The Self Park function will automatically return the light to a specific position when turned off. When mounting the light, determine in advance the direction that the light should face when it is turned off. Align the red marker on the base 180° opposite of the final facing direction.

To activate the Self-Park feature, press the “Speed” button on the UPR-102 Point Pad™ for more than five (5) seconds.

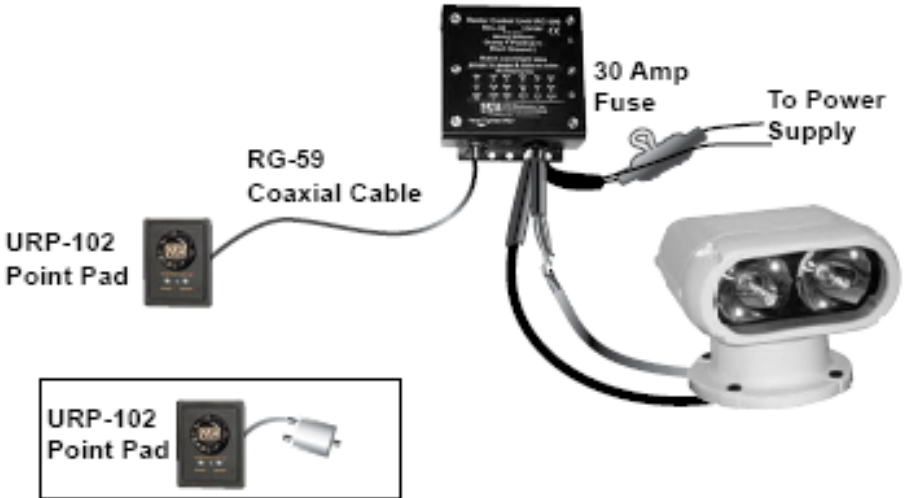

Figure 2- URC-300 Master Controller unit (mounted upright)
Single Point Pad connection configuration

SECTION 3 - REMOTE CONTROL SYSTEM

The Remote Control System consists of the URC-300 Master Controller and the UPR-102 Point Pad™. This system is compatible with 12 VDC through 24 VDC systems without modification.

SECTION 4 - UPR-102 POINT PAD™

Case options

The UPR-102 Point Pad™ is supplied as a surface mount unit (see Figure 3). A flush mount option is provided. To switch mounting options, unscrew the six (6) screws on the unit's back plate and remove the front cover. Fit the Point Pad™ with the flush mount cover, replace the back plate and screw the unit back together.

Mounting

Both the surface mount and the flush mount options require access to the backside of the mounting location. Verify that there are not any obstructions behind the area where the switch is to be located, e.g., bulkheads, wires, plumbing or hardware. Check that the coax cable from the Master Controller can be routed to this location. Generally, the Point Pad™ should be mounted in a protected area.

Surface Mount

Install the surface mount Point Pad™ by drilling three (3) holes in the dashboard location using the Point Pad™ Surface Mount Template supplied in the Mounting Templates. Mount the Point Pad to the dashboard using the gasket, washers and nuts supplied. Apply a sealant around the bolt holes to protect from moisture intrusion.



URP-102
Surface mount



URP-102
Flush mount

Flush Mount

When the flush mount is selected, cut a rectangular hole in the dashboard location using the Point Pad™ Flush Mount Template supplied in the Mounting Templates. Use the gasket, washers, nuts and the two U-Clamps provided to secure the Point Pad™. Apply a sealant around the cut out to protect from moisture intrusion.

Connecting to the Master Controller

The Point Pad™ communicates with the Master Controller via standard television type RG-59 coaxial cable. The connectors are standard “F” type television connectors. The connector on the back of the Point Pad™ is located in the center of the panel for ease of installation. After the coax cable has been routed and the “F” connector is attached to the coax cable, screw the “F” connectors to the Master Controller and the Point Pad™.

Additional Point Pads™ (up to three) may be used with one (1) Master Controller. A standard “T” connector or RG-59 television type splitter is used for each additional Point Pad™. Limit the total length of all coax cable used to 300 feet.

SECTION 5 - URC-300 MASTER CONTROLLER

Mounting

The Master Controller can be mounted in any position near the searchlight that is protected from the weather. Check in advance that the coax cable from the Point Pad and the wiring harness from the searchlight can be routed to this location. Mount the Master Controller with the wires and coax facing down. Use an appropriate fastener for your mounting location. Use a sealant in fastener holes to prevent moisture intrusion.

General wiring scheme

 **WARNING:** The RCL-300 has a unique wiring scheme. Special attention must be paid to the following chart.

The Master Controller is supplied with an in-line fuse-holder on the Orange power lead. Use only 30 amp fuses in this fuse-holder. See chart below for the Master Controller wiring diagram.

 **WARNING:** Failure to follow this arrangement may damage components.

Master Controller Wire	Searchlight Cable Wire	Wire Gauge (AWG)	Power Source Lead	Function
Orange		16	+12 VDC or +24 VDC**	URC-300 Power
Blue		16	Ground	URC-300 Ground
Yellow	Yellow	16		Position Sensor Signal
Green	Green	16		Position Sensor Common
Red	Red	16		Up
White	White	16		Down
Black	Black	16		Right
Brown	Brown	16		Left
White	White	12		Lamp Power
Black	Black	12		Lamp Ground

Table 1

 **WARNING:** This wire MUST be fused with a 30 amp fuse in the Master Controller's in-line fuse-holder.

Wiring to the searchlight

The RCL-300A searchlight is supplied with a 15-foot integral wire harness. If you must lengthen the wire harness, use heavy duty wire to minimize the voltage drop. This is especially important for the WHITE 12 AWG lamp power, BLACK 12 AWG lamp ground, ORANGE power wire and BLUE ground wires.

Following the wiring scheme above and Appendix C, use the supplied butt connectors to connect the Master Controller to the searchlight.

Wiring the Point Pad™

The RG-59 coax cable is supplied without the “F” connectors attached for ease of routing. After the Coax cable has been routed, strip the insulation and crimp the “F” connectors in place. Screw the “F” connectors to the Master Controller and the Point Pad™.

Wiring to the power supply

The power source must be a fused 12 VDC, 30-amp supply or a 24 VDC, 15-amp supply. Following the wiring scheme in Table 1, use the supplied butt connectors to connect the Master Controller to the power source. Refer to Table 2 for proper wire size for connection of the input power lines.



Figure 5

NOTE: As per the wiring scheme, the ORANGE wire is connected to the positive terminal and the BLUE wire is connected to the negative terminal of the power source.



CAUTION: HID light systems, when first turned on, have a high inrush current requirement of 25 amps. If you activate the light and the lamps flicker on and off repeatedly, check the voltage being supplied. This condition can be experienced with voltage input of less than 11.5V.

Functions of the URC-300

The URC-300 Master Controller is designed to perform up to six different duties on searchlights, winches and other electrical devices. The Master Controller provides optimum voltage to ensure brightest performance and long lamp life, regardless of boat system voltage fluctuations. The Master Controller is compatible with devices requiring 12 VDC through 24 VDC operation.

The URC-300 Master Controller has a searchlight motor time-out feature. If a Point Pad™ rotation switch (right or left) is continually engaged for more than 50 seconds, the Master Controller will interrupt the operation until the Point Pad switch is disengaged. This feature will save the searchlight motor from burnout due to accidental activation. The elevation motor has similar features which will timeout in approximately 20 seconds.

XRCiZ™ feature

The URC-300 Master Controller has the unique XRCiZ™ feature. The XRCiZ™ feature routinely operates all moving parts of the searchlight to keep the motors and drive mechanism freely running. Once activated, and every 30 days thereafter, the XRCiZ™ feature wakes up and operates the searchlight. The searchlight will rotate 360° in both directions and the parabolic reflectors will move to the full up and down positions. This feature keeps the searchlight in peak working order when not in service for long periods of time.

To activate the XRCiZ™ feature, press and hold the Point Pad™ ON/OFF button for greater than 5 seconds. The green LED on the URP-102 Point Pad™ indicates that the XRCiZ™ feature is enabled.

While the XRCiZ™ feature is operating the searchlight, pressing any Point Pad™ button will stop the XRCiZ™ command.

To deactivate the XRCiZ™ feature, press and hold the Point Pad ON/OFF button for greater than 5 seconds. The red LED on the URP-102 Point Pad™ indicates that the XRCiZ™ feature is disabled.

NOTE: The Searchlight should not be covered while the XRCiZ™ feature is enabled.

Self- Park feature

The URC-300 Master Controller has a Self- Park feature. When the Self-Park feature is activated, it will automatically return the searchlight to the forward (or aft, if mounted as such) position when the searchlight lamps are turned off. The feature also works with the XRCiZ™ function to return the searchlight to it Self-Park position.

SECTION 6 - POINT PAD™ OPERATION

- Press the On/OFF button to turn the lights ON or OFF.
- Press the SPEED button to toggle between High and low rotation speeds.
- Press the Right or Left arrows to rotate the searchlight in the direction.

- Press the Up or Down arrows to raise or lower the searchlight beam.
- To activate the XRCiZ™ feature, press and hold the ON/OFF button for more than 5 seconds. The green LED indicates that the XRCiZ™ feature is enabled.
- To deactivate the XRCiZ™ feature, press and hold the ON/OFF button for more than 5 seconds. The red LED indicates that the XRCiZ™ feature is disabled.
- An LED blinking red/green indicates that the XRCiZ™ feature is now “exercising” the searchlight.
- To activate the Self-Park feature, press and hold the Point Pad™ Speed button for more than 5 seconds.
- While the Self-Park feature is operating the searchlight, pressing any Point Pad™ button will stop the park command and leave the searchlight to follow any additional commands.
- To deactivate the Self-Park feature, press and hold the Point Pad™ Speed button for more than 5 seconds.
- An LED blinking red/green indicates that the searchlight is seeking its Self-Park position.
- The Self-Park and XRCiZ™ features are normally disabled when power is lost to the URC-300 Master Controller and will have to be reactivated.

NOTE: Self-Park and the XRCiZ™ features are only available when paired with a URC-300 Master Controller.

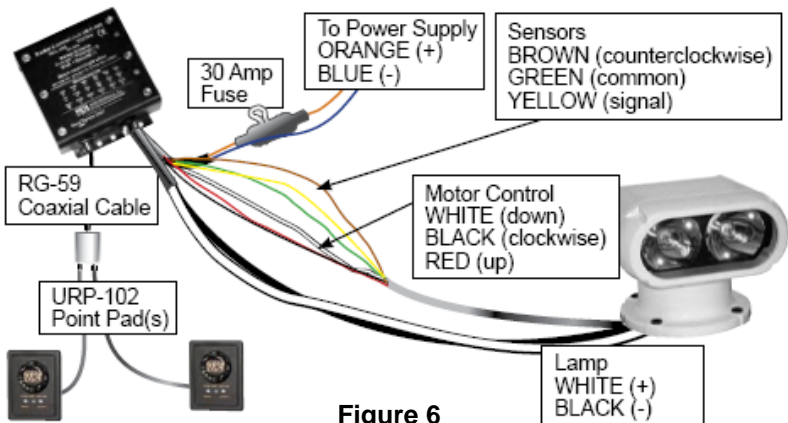



Figure 6

APPENDIX A - SPECIFICATIONS

Characteristics	Specification
Size	12 X 13 X 9.3 in (31 X 33 X 23.5 cm)
Weight	31 lb (14.06 kg)
Material	Cast aluminum, tempered glass
Input voltage*	12V- 24V
Amp draw	Startup 25A @ 12V, Running 8A @ 12V
Color	White
Operation	Remote controlled Point Pad™
Beam spread	6°
Elevation angle	12° up, 38° down
Rotation	360° continuous
Rotation speed	Fast 30° per second, Slow 12° per second
Elevation speed	7° per second
Lamp	- Twin 35W metal halide lamps - 1,000 hours operating life
Accessories	- Secondary Point Pad for remote control with Install Kit (ACR P/N 9282.3) - Replacement 35W halide lamp (ACR P/N 6009)
Footprint diameter	9 in (23 cm)
Limited warranty	1 year
Carton dimensions	20.5 X 14.25 X 19.25 in (52.07 X 36.20 X 48.90 cm)
Carton weight	40 lb (18.14 kg)

 ***CAUTION:** HID light systems, when first turned on, have a high inrush current requirement of 25 amps. If you activate the light and the lamps flicker on and off repeatedly, check the voltage being supplied. This condition can be experienced with voltage input of less than 11.5V.

APPENDIX B - KIT COMPONENTS

Product No. 1930.3 - RCL-100D 12 V Searchlight Installation Kit includes:

Description	Quantity	ACR Part Number
Searchlight, RCL-300A	1	A3-06-2558
Point Pad™, URP-102 with surface mount case	1	A3-06-2230
URC-300 Master Controller unit	1	A3-06-2231-1
Case, flush mount	1	A1-18-1875-2
Gasket, surface mount	1	A1-25-0140-1
Gasket, flush mount	1	A1-25-0140-2
U Clamp	2	A1-17-1366
Nuts, nylon- lock	2	A1-05-0776
Washers	2	A1-05-0777
Cable, coaxial	30ft	A2-07-0002-6
Connector, "F"	2	A1-03-0220
Flanged 8 steel 12-10 AWG	2	A1-05-0861-8
Flanged 8 stud 16-14 AWG	8	A1-05-0861-5

APPENDIX C - WIRING DIAGRAM

RCL-300A

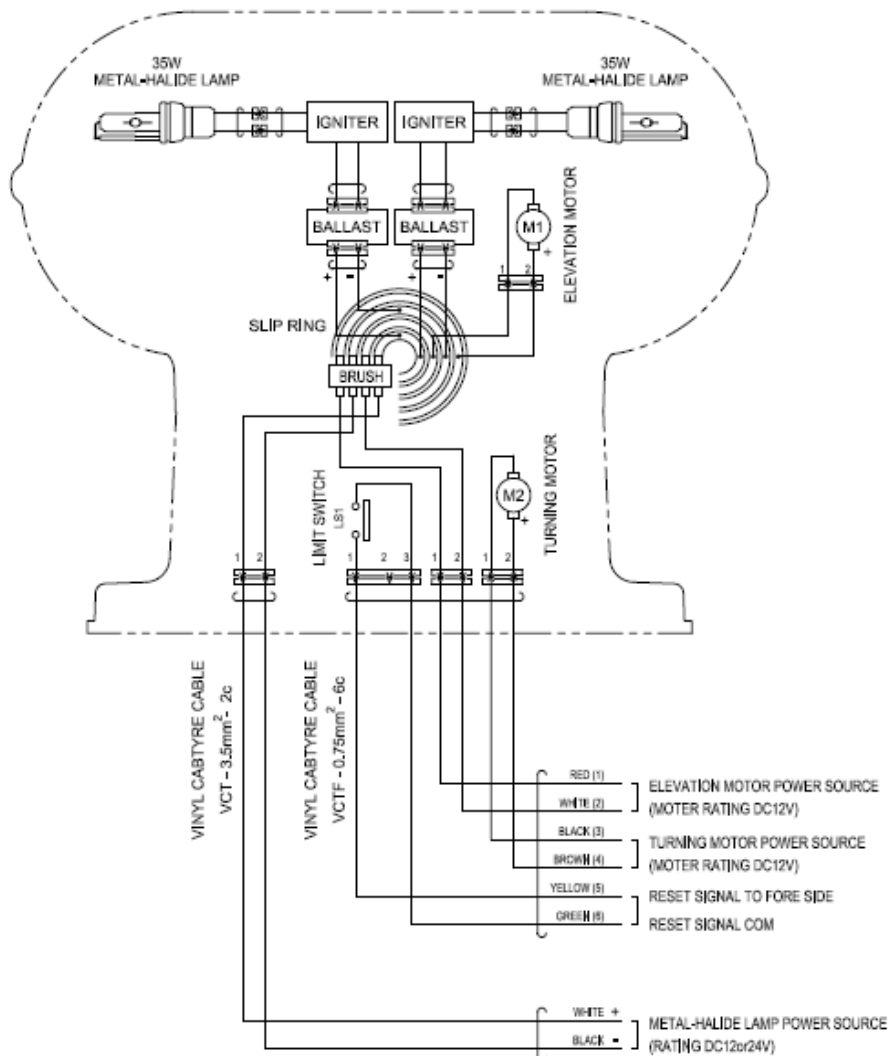

APPENDIX D - WARRANTY, USEFUL LIFE POLICY, NOTICES

Limited Warranty

This product is warranted against factory defects in material and workmanship for a period of 1 (one) year* from date of purchase or receipt as a gift. During the warranty period ACR Electronics, Inc. will repair or, at its option, replace the unit at no cost to you for labor, materials and return transportation from ACR. For further assistance, please contact our Technical Service Department at ACR Electronics, Inc., 5757 Ravenswood Road, Fort Lauderdale, FL 33312-6645. Email: service@acrelectronics.com, Fax: +1 (954) 983-5087, Telephone: +1 (954) 981-3333.

This warranty does not apply if the product has been damaged by accident or misuse, or as a result of service or modification performed by an unauthorized factory. Except as otherwise expressly stated in the previous paragraph, THE COMPANY MAKES NO REPRESENTATION OR WARRANTY OF ANY KIND, EXPRESS OR IMPLIED, AS TO MERCHANTABILITY, FITNESS FOR A PARTICULAR PURPOSE, OR ANY OTHER MATTER WITH RESPECT TO THIS PRODUCT. The Company shall not be liable for consequential or special damages.

To place the warranty in effect, register online at www.acrelectronics.com or return the attached card within 10 days.

*Five years for the following products: EPIRB, PLB, S-VDR, SSAS.

Useful Life Policy

The typical service life of a properly maintained Product is limited to 12 years from date of manufacture. Products that are 12 years and 1 month or older from date of manufacture will not be serviced by ACR or our Battery Replacement Centers. A Product that is 12 or less years old from date of manufacture will be serviced as long as the unit appears fit to be placed back into its final operational cycle. Service includes the replacement of those items that must be replaced at service intervals and the verification that the device appears to be in good mechanical and electrical working condition by an ACR authorized service technician.

Notices

ACR Electronics diligently works to provide a high quality Product Support Manual, however, despite best efforts, information is subject to change without notice, and omissions and inaccuracies are possible. ACR cannot accept liability for manual contents. To ensure that you have the most recent version of the Product Support Manual, please visit the ACR website at www.acrelectronics.com.

©2008 by ACR Electronics, Inc., part of Cobham plc. All rights reserved. Reproduction in whole or in part is permitted only with permission of ACR Electronics, Inc. Ongoing product improvements may change product specifications without notice.

Trademarks or registered trademarks are the property of their respective owners.

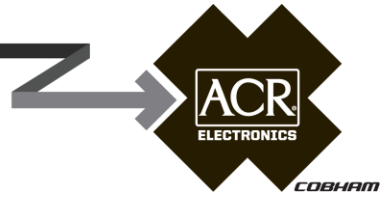

EC DECLARATION OF CONFORMITY

ACR Electronics, Inc. hereby declares that the following product is in conformity with Directive 2004/108/EC of the European Parliament and of the Council of 15 December 2004 on Electromagnetic Compatibility (EMC Directive). In accordance with the Directive, the product will be marked with the CE conformity marking as follows:



Product: Searchlight
Model: RCL-300A

Regulations and Standards: EN 60945: 2002: Emissions:
CISPR 16-1:1999 (Conducted Emissions)
CISPR 16-1:1999 (Radiated Emissions)
EN 60945: 2002: Immunity:
IEC 61000-4-2: 1995 (Electrostatic Discharge)
IEC 61000-4-3: 1995 (Radiated Immunity)
IEC 61000-4-6: 1996 (Conducted Immunity, Power and I/O Leads)
IEC 61000-4-11: 1994 (Voltage Dips and Interrupts)

Manufacturer: ACR Electronics Inc.
5757 Ravenswood Road
Fort Lauderdale, FL 33312
USA

European Representative: ACR Electronics Inc.
(European Office)
1 Rose Cottages, Pitmore Lane,
Sway, Lyminster, Hampshire
SO41 6BX UK

Signed on behalf of ACR Electronics Inc.

Signed: 

Name: Kerry Greer **Date:** February 26, 2009

Title: Executive Director -
Research & Development

Document RCL-300-002

This Declaration complies with
ISO/IEC 17050-1:2004



ACR Electronics, Inc. is registered by UL to ISO 9001:2000