

Nokia 7510 Supernova User Guide

9210904
Issue 1

DECLARATION OF CONFORMITY

CE 0434

Hereby, NOKIA CORPORATION declares that this RM-398 product is in compliance with the essential requirements and other relevant provisions of Directive 1999/5/EC. A copy of the Declaration of Conformity can be found at http://www.nokia.com/phones/declaration_of_conformity/.

© 2008 Nokia. All rights reserved.

Nokia, Nokia Connecting People and Navi are trademarks or registered trademarks of Nokia Corporation. Nokia tune is a sound mark of Nokia Corporation. Other product and company names mentioned herein may be trademarks or tradenames of their respective owners.

Reproduction, transfer, distribution, or storage of part or all of the contents in this document in any form without the prior written permission of Nokia is prohibited.

US Patent No 5818437 and other pending patents. T9 text input software Copyright © 1997-2008. Tegic Communications, Inc. All rights reserved.



Includes RSA BSAFE cryptographic or security protocol software from RSA Security.



Java and all Java-based marks are trademarks or registered trademarks of Sun Microsystems, Inc.

This product is licensed under the MPEG-4 Visual Patent Portfolio License (i) for personal and noncommercial use in connection with information which has been encoded in compliance with the MPEG-4 Visual Standard by a consumer engaged in a personal and noncommercial activity and (ii) for use in connection with MPEG-4 video provided by a licensed video provider. No license is granted or shall be implied for any other use. Additional information, including that related to promotional, internal, and commercial uses, may be obtained from MPEG LA, LLC. See <http://www.mpegla.com>

Nokia operates a policy of ongoing development. Nokia reserves the right to make changes and improvements to any of the products described in this document without prior notice.

TO THE MAXIMUM EXTENT PERMITTED BY APPLICABLE LAW, UNDER NO CIRCUMSTANCES SHALL NOKIA OR ANY OF ITS LICENSORS BE RESPONSIBLE FOR ANY LOSS OF DATA OR INCOME OR ANY SPECIAL, INCIDENTAL, CONSEQUENTIAL OR INDIRECT DAMAGES HOWSOEVER CAUSED.

THE CONTENTS OF THIS DOCUMENT ARE PROVIDED "AS IS". EXCEPT AS REQUIRED BY APPLICABLE LAW, NO WARRANTIES OF ANY KIND, EITHER EXPRESS OR IMPLIED, INCLUDING, BUT NOT LIMITED TO, THE IMPLIED WARRANTIES OF MERCHANTABILITY AND FITNESS FOR A PARTICULAR PURPOSE, ARE MADE IN RELATION TO THE ACCURACY, RELIABILITY OR CONTENTS OF THIS DOCUMENT. NOKIA RESERVES THE RIGHT TO REVISE THIS DOCUMENT OR WITHDRAW IT AT ANY TIME WITHOUT PRIOR NOTICE.

The availability of particular products and applications and services for these products may vary by region. Please check with your Nokia dealer for details, and availability of language options.

Export controls

This device may contain commodities, technology or software subject to export laws and regulations from the US and other countries. Diversion contrary to law is prohibited.

FCC/INDUSTRY CANADA NOTICE

Your device may cause TV or radio interference (for example, when using a telephone in close proximity to receiving equipment). The FCC or Industry Canada can require you to stop using your telephone if such interference cannot be eliminated. If you require assistance, contact your local service facility. This device complies with part 15 of the FCC rules. Operation is subject to the following two conditions: (1) This device may not cause harmful interference, and (2) this device must accept any interference received, including interference that may cause undesired operation. Any changes or modifications not expressly approved by Nokia could void the user's authority to operate this equipment.

Model number: 7510a

9210904/Issue 1

Contents

Safety	7	4. Write text	21
1. General information	8	Text modes.....	21
About your device.....	8	Traditional text input.....	21
Network services.....	8	Predictive text input.....	21
Access codes.....	8	5. Messaging	22
Configuration setting service.....	9	Text and multimedia messages.....	22
My Nokia.....	9	Text messages.....	22
Download content.....	9	Multimedia messages.....	22
Helpful hints.....	10	Create a text or multimedia message.....	22
Software updates.....	10	Read a message and reply.....	23
Nokia support.....	10	Send messages.....	23
Digital rights management.....	11	E-mail.....	24
2. Get started	11	E-mail setup wizard.....	24
Install SIM card and battery.....	11	Write and send an e-mail.....	24
Insert a microSD card.....	12	Read an e-mail and reply.....	24
Remove the memory card.....	13	New e-mail notifications.....	24
Change the covers.....	13	Flash messages.....	25
Charge the battery.....	13	Nokia Xpress audio messages.....	25
Antenna.....	14	Instant messaging.....	25
Connect a USB cable.....	14	Info messages, SIM messages, and service commands.....	25
Headset.....	14	Voice messages.....	26
Strap.....	15	Message settings.....	26
Keys and parts.....	15	6. Contacts	26
Switch the phone on and off.....	16	Manage contacts.....	27
Navigate the menus.....	16	Business cards.....	28
Standby mode.....	17	Assign dialling shortcuts.....	28
Display.....	17	7. Call log	28
Home screen.....	17	8. Position log	28
Shortcuts in the standby mode.....	17	9. Connectivity	29
Indicators.....	18	Bluetooth wireless technology.....	29
Flight mode.....	18	Packet data.....	30
Keypad lock.....	19	USB data cable.....	30
Functions without a SIM card.....	19	Synchronisation and backup.....	30
3. Calls	19	Nokia PC Suite.....	31
Make a call.....	19	10. Settings	31
Answer and end a call	19		
Dialling shortcuts.....	20		
Voice dialling.....	20		
Options during a call.....	20		

Profiles.....	31	Maps.....	43
Themes.....	31	Download maps.....	43
Tones.....	31	Maps and GPS.....	44
Lights.....	31	Extra services.....	44
Display.....	32	To-do list.....	45
Date and time.....	32	Notes.....	45
My shortcuts.....	32	Calculator.....	45
Left and right selection keys.....	32	Countdown timer.....	45
Other shortcuts.....	32	Stopwatch.....	46
Call.....	33	15. Applications.....	46
Phone.....	33	Launch an application.....	46
Voice commands.....	34	Download an application.....	46
Accessories.....	34	16. Web	47
Configuration.....	34	Connect to a service.....	47
Software updates over the air.....	35	Web uploads.....	47
Security.....	35	Appearance settings.....	48
Restore factory settings.....	36	Cache memory.....	48
11. Operator menu.....	36	Browser security.....	48
12. Gallery.....	37	17. SIM services.....	49
Folders and files.....	37	Enhancements.....	50
Print images.....	37	Battery.....	50
Share images and videos online.....	37	Battery and charger information.....	50
Memory card.....	37	Nokia battery authentication	
13. Media.....	38	guidelines.....	51
Camera and video.....	38	Authenticate hologram.....	51
Take a picture.....	38	What if your battery is not	
Record a video clip.....	38	authentic?.....	52
Camera and video options.....	39	Care and maintenance.....	52
Media player.....	39	Disposal.....	53
Music menu.....	39	Additional safety	
Play songs.....	40	information.....	53
Change the media player look.....	40	Small children.....	53
Radio.....	40	Operating environment.....	53
Tune in to radio stations.....	41	Medical devices.....	54
Radio settings.....	41	Implanted medical devices.....	54
Voice recorder.....	41	Hearing aids.....	54
Equaliser.....	42	Vehicles.....	54
Stereo widening.....	42		
14. Organiser.....	42		
Alarm clock.....	42		
Calendar.....	43		

Contents

Potentially explosive environments.....	55
Emergency calls.....	55
Certification information (SAR).....	56

Index.....	57
-------------------	-----------

Safety

Read these simple guidelines. Not following them may be dangerous or illegal. Read the complete user guide for further information.



SWITCH ON SAFELY

Do not switch the device on when wireless phone use is prohibited or when it may cause interference or danger.



ROAD SAFETY COMES FIRST

Obey all local laws. Always keep your hands free to operate the vehicle while driving. Your first consideration while driving should be road safety.



INTERFERENCE

All wireless devices may be susceptible to interference, which could affect performance.



SWITCH OFF IN RESTRICTED AREAS

Follow any restrictions. Switch the device off in aircraft, near medical equipment, fuel, chemicals, or blasting areas.



QUALIFIED SERVICE

Only qualified personnel may install or repair this product.



ENHANCEMENTS AND BATTERIES

Use only approved enhancements and batteries. Do not connect incompatible products.



WATER-RESISTANCE

Your device is not water-resistant. Keep it dry.

1. General information

About your device

The wireless device described in this guide is approved for use on the GSM 850, 900, 1800, and 1900 MHz networks. Contact your service provider for more information about networks.

When using the features in this device, obey all laws and respect local customs, privacy and legitimate rights of others, including copyrights.

Copyright protection may prevent some images, music, and other content from being copied, modified, or transferred.

Your device may have preinstalled bookmarks and links for third-party internet sites. You may also access other third-party sites through your device. Third-party sites are not affiliated with Nokia, and Nokia does not endorse or assume liability for them. If you choose to access such sites, you should take precautions for security or content.



Warning: To use any features in this device, other than the alarm clock, the device must be switched on. Do not switch the device on when wireless device use may cause interference or danger.

Remember to make back-up copies or keep a written record of all important information stored in your device.

When connecting to any other device, read its user guide for detailed safety instructions. Do not connect incompatible products.

Network services

To use the device you must have service from a wireless service provider. Many of the features require special network features. These features are not available on all networks; other networks may require that you make specific arrangements with your service provider before you can use the network services. Using network services involves transmission of data. Check with your service provider for details about fees in your home network and when roaming on other networks. Your service provider can give you instructions and explain what charges will apply. Some networks may have limitations that affect how you can use network services. For instance, some networks may not support all language-dependent characters and services.

Your service provider may have requested that certain features be disabled or not activated in your device. If so, these features will not appear on your device menu. Your device may also have a special configuration such as changes in menu names, menu order, and icons. Contact your service provider for more information.

Access codes

To set how your phone uses the access codes and security settings, select **Menu** > **Settings** > **Security** > **Access codes**.

- The PIN (UPIN) code, supplied with the SIM (USIM) card, helps to protect the card against unauthorised use.
- The PIN2 (UPIN2) code, supplied with some SIM (USIM) cards, is required to access certain services.
- PUK (UPUK) and PUK2 (UPUK2) codes may be supplied with the SIM (USIM) card. If you enter the PIN code incorrectly three times in succession, you are asked for the PUK code. If the codes are not supplied, contact your service provider.
- The security code helps to protect your phone against unauthorised use. You can create and change the code, and set the phone to request the code. Keep the code secret and in a safe place separate from your phone. If you forget the code and your phone is locked, your phone will require service and additional charges may apply. For more information, contact a Nokia Care point or your phone dealer.
- The barring password is required when using the call barring service to restrict calls to and from your phone (network service).
- To view or change the security module settings for the web browser, select **Menu > Settings > Security > Security module sett..**

Configuration setting service

To use some of the network services, such as mobile internet services, the multimedia messaging service (MMS), Nokia Xpress audio messaging, or remote internet server synchronisation, your phone needs the correct configuration settings. For more information on availability, contact your service provider or the nearest authorised Nokia dealer, or visit the support area on the Nokia website. [See "Nokia support", p. 10.](#)

When you have received the settings as a configuration message and the settings are not automatically saved and activated, **Configuration settings received** is displayed.

To save the settings, select **Show > Save**. If required, enter the PIN code supplied by the service provider.

My Nokia

Receive free tips, tricks, and support for your Nokia phone, plus free trial content, interactive demonstrations, a personalised web page, and news about the latest Nokia products and services.

Get the most out of your Nokia phone and register to My Nokia today! For more information and availability in your region, see www.nokia.com/mynokia.

Download content

You may be able to download new content (for example, themes) to your phone (network service).



Important: Use only services that you trust and that offer adequate security and protection against harmful software.

For the availability of different services and pricing, contact your service provider.

Helpful hints

If you have queries with your phone, or you are unsure how your phone should function, refer to the user guide. If this does not help, try the following:

- Reset the phone: switch off the phone, and remove the battery. After a few seconds, insert the battery, and switch on the phone.
- Restore the factory settings. [See "Restore factory settings", p. 36.](#)
- Update your phone software with the Nokia Software Updater application, if available. [See "Software updates", p. 10.](#)
- Visit a Nokia website, or contact Nokia Care. [See "Nokia support", p. 10.](#)

If a query remains unresolved, contact your local Nokia Care point for repair options. Before sending your phone for repair, always back up or make a record of data in your phone.

Software updates

Nokia may produce software updates that may offer new features, enhanced functions, or improved performance. You may be able to request these updates through the Nokia Software Updater PC application. To update the device software, you need the Nokia Software Updater application and a compatible PC with Microsoft Windows 2000, XP or Vista operating system, broadband internet access, and a compatible data cable to connect your device to the PC.

To get more information and to download the Nokia Software Updater application, visit www.nokia.com/softwareupdate or your local Nokia website.

If software updates over the air are supported by your network, you may also be able to request updates through the phone. [See "Software updates over the air", p. 35.](#)



Important: Use only services that you trust and that offer adequate security and protection against harmful software.

Nokia support

Check www.nokia.com/support or your local Nokia website for the latest version of this guide, additional information, downloads, and services related to your Nokia product.

Configuration settings service

Download free configuration settings such as MMS, GPRS, e-mail, and other services for your phone model at www.nokia.com/support.

Nokia PC Suite

You may find PC Suite and related information on the Nokia website at www.nokia.com/support.

Nokia Care services

If you need to contact Nokia Care services, check the list of local Nokia Care contact centres at www.nokia.com/customerservice.



Maintenance

For maintenance services, check your nearest Nokia Care point at www.nokia.com/repair.

Digital rights management

Content owners may use different types of digital rights management (DRM) technologies to protect their intellectual property, including copyrights. This device uses various types of DRM software to access DRM-protected content. With this device you can access content protected with WMDRM 10, OMA DRM 1.0, OMA DRM 1.0 forward lock, and OMA DRM 2.0. If certain DRM software fails to protect the content, content owners may ask that such DRM software's ability to access new DRM-protected content be revoked. Revocation may also prevent renewal of such DRM-protected content already in your device. Revocation of such DRM software does not affect the use of content protected with other types of DRM or the use of non-DRM-protected content.

Digital rights management (DRM) protected content comes with an associated activation key that defines your rights to use the content.

If your device has OMA DRM-protected content, to back up both the activation keys and the content, use the backup feature of Nokia PC Suite. Other transfer methods may not transfer the activation keys which need to be restored with the content for you to be able to continue the use of OMA DRM-protected content after the device memory is formatted. You may also need to restore the activation keys in case the files on your device get corrupted.

If your device has WMDRM-protected content, both the activation keys and the content will be lost if the device memory is formatted. You may also lose the activation keys and the content if the files on your device get corrupted. Losing the activation keys or the content may limit your ability to use the same content on your device again. For more information, contact your service provider.

2. Get started

Install SIM card and battery

Always switch the device off and disconnect the charger before removing the battery.

This phone is intended for use with a BL-5BT battery. Always use original Nokia batteries. [See "Nokia battery authentication guidelines", p. 51.](#)

Get started

The SIM card and its contacts can be easily damaged by scratches or bending, so be careful when handling, inserting, or removing the card.

1. Slide the cover (1), and remove it. Remove the battery (2).
2. Open the SIM card holder (3). Insert the SIM card with the contact surface facing down into the holder (4). Close the SIM card holder (5).
3. Observe the battery contacts (6), and insert the battery (7). Replace the back cover (8).

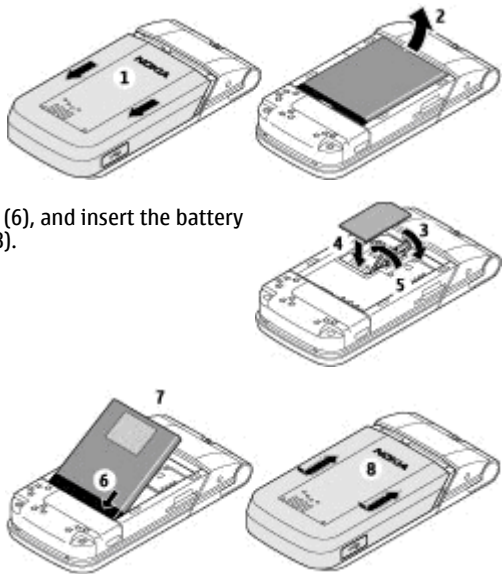

Insert a microSD card

Use only compatible microSD cards approved by Nokia for use with this device. Nokia uses approved industry standards for memory cards, but some brands may not be fully compatible with this device. Incompatible cards may damage the card and the device and corrupt data stored on the card.

Your phone supports microSD cards of up to 8 GB.

1. Remove the back cover.
2. Insert the card into the memory card slot with the contact surface facing down, and press until it locks into place.
3. Replace the back cover.



Remove the memory card



Important: Do not remove the memory card in the middle of an operation when the card is being accessed. Removing the card in the middle of an operation may damage the memory card as well as the device, and data stored on the card may be corrupted.

You can remove or replace the memory card during phone operation without switching the device off.

1. Ensure that no application is currently accessing the memory card.
2. Remove the back cover.
3. Press the memory card slightly in to release the lock, and remove it.
4. Replace the back cover.

Change the covers



Note: Always switch off the power and disconnect the charger and any other device before removing the covers. Avoid touching electronic components while changing the covers. Always store and use the device with the covers attached.

Remove covers

Slide the cover until it unlocks, and remove it.

Replace covers

Place the cover on the device, and slide it until it locks.

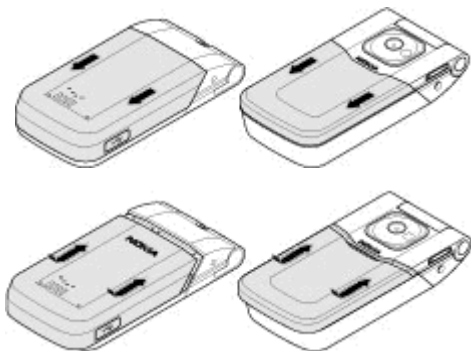

Charge the battery

Your battery has been precharged, but the charging levels may vary.

1. Connect the charger to a wall outlet.

Get started

2. Connect the charger to the device. During charging, the reminder light flashes up about every 30 seconds.
3. When the battery is fully charged, disconnect the charger from the device, then from the wall outlet.

If the battery is completely discharged, it may take a few minutes before the charging indicator appears on the display or before any calls can be made.

The charging time depends on the charger used. Charging a BL-5BT battery with the AC-3 charger takes approximately 2 hours 40 minutes while the phone is in the standby mode.



Antenna

Your device may have internal and external antennas. As with any radio transmitting device, avoid touching the antenna area unnecessarily while the antenna is transmitting or receiving. Contact with such an antenna affects the communication quality and may cause the device to operate at a higher power level than otherwise needed and may reduce the battery life.

The figure shows the antenna area marked in grey.





Connect a USB cable

Open the cover of the USB connector, and connect the USB cable to the device.



Headset

 **Warning:** Listen to music at a moderate level. Continuous exposure to high volume may damage your hearing. Do not hold the device near your ear when the loudspeaker is in use, because the volume may be extremely loud.

 **Warning:** When you use the headset, your ability to hear outside sounds may be affected. Do not use the headset where it can endanger your safety.

When connecting any external device or any headset, other than those approved by Nokia for use with this device, to the Nokia AV Connector, pay special attention to volume levels.

Do not connect products that create an output signal as this may cause damage to the device. Do not connect any voltage source to the Nokia AV Connector.

Strap

Thread a strap as shown in the picture and tighten it.



Keys and parts

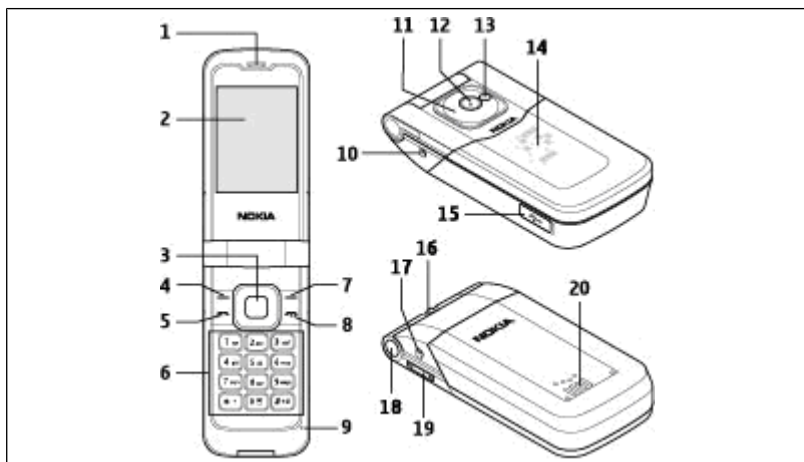

1	Earpiece	2	Display
3	Navi™ key; hereafter referred to as scroll key	4	Left selection key
5	Call key	6	Keypad
7	Right selection key	8	Power/End key

Get started

9	Microphone	10	Charger connector
11	Reminder light	12	Camera lens
13	Camera flash	14	Hidden cover display
15	Mini USB cable connector	16	Wrist strap eyelet
17	Nokia AV Connector (2.5 mm)	18	Fold release button
19	Volume keys	20	Loudspeaker

Switch the phone on and off

To switch the phone on or off, press and hold the power key.

If the phone prompts for a PIN code, enter the code (displayed as ****).

If the phone prompts you for the time and date, enter the local time, select the time zone of your location in terms of the time difference with respect to Greenwich Mean Time (GMT), and enter the date. See ["Date and time", p. 32](#).

When you switch on your phone for the first time, you may be prompted to get the configuration settings from your service provider (network service). For more information, refer to **Connect to support**. See ["Configuration", p. 34](#), and ["Configuration setting service", p. 9](#).

Navigate the menus

The phone offers you an extensive range of functions that are grouped into menus.

1. To access the menu, select **Menu**.
2. Scroll through the menu, and select an option (for example, **Settings**).
3. If the selected menu contains further submenus, select one (for example, **Call**).
4. If the selected menu contains further submenus, repeat step 3.
5. Select the setting of your choice.
6. To return to the previous menu level, select **Back**.

To exit the menu, select **Exit**.



To change the menu view, select **Options** > **Main menu view**. Scroll right, and select from the available options.

To rearrange the menu, select **Options** > **Organise**. Scroll to the menu item to be moved, and select **Move**. Scroll to where you want to move the menu item, and select **OK**. To save the change, select **Done** > **Yes**.

Standby mode

When the phone is ready for use, and you have not entered any characters, the phone is in the standby mode.

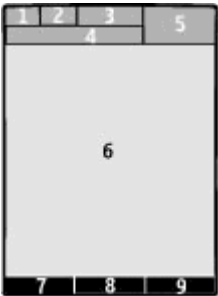
Display

1	Signal strength of the cellular network 	
2	Battery charge status 	
3	Indicators	
4	Name of the network or the operator logo	
5	Clock	
6	Display	
7	Function of the left selection key	
8	Function of the Navi key	
9	Function of the right selection key	

You may change the function of the left and right selection key. [See "Left and right selection keys", p. 32.](#)

Home screen

The home screen mode displays a list of selected phone features and information that you can directly access.

To activate or deactivate the home screen mode, select **Menu** > **Settings** > **Display** > **Home screen** > **Home screen mode**.

To organise and change the home screen mode, select **Menu** > **Settings** > **Display** > **Home screen** > **Personalise view** and from the available options.

To select the key that is used to activate the home screen mode, select **Menu** > **Settings** > **Display** > **Home screen** > **Home screen key** and from the available options.

Depending on the setting, in the home screen mode, scroll up or down to navigate in the list, and select **Select**, **View**, or **Edit**. The arrows indicate that further information is available. To stop navigation, select **Exit**.

Shortcuts in the standby mode

To access a list of numbers you have dialled, press the call key once. To call a number from the list, scroll to the number or name, and press the call key.

Get started

To open the web browser, press and hold **0**.

To call your voice mailbox, press and hold **1**.

You can use keys as shortcuts. [See "Dialling shortcuts", p. 20.](#)

Indicators

 You have unread messages.

 You have unsent, cancelled, or failed messages.

 You have missed calls.

 The keypad is locked.

 The phone does not ring for incoming calls or text messages.

 An alarm is set.

 The phone is registered to the GPRS or EGPRS network.

 The phone has an open GPRS or EGPRS connection.

 The GPRS or EGPRS connection is suspended (on hold).

 Bluetooth connectivity is turned on.

 If you have two phone lines, the second phone line is selected.

 All incoming calls are diverted to another number.

 Calls are limited to a closed user group.

 The currently active profile is timed.

Flight mode

Use the flight mode in radio sensitive environments—on board aircraft or in hospitals—to deactivate all radio frequency functions. You still have access to offline games, the calendar, and phone numbers. When the flight mode is active,  is displayed.

To activate or set up the flight mode, select **Menu > Settings > Profiles > Flight > Activate or Personalise**.

To deactivate the flight mode, select any other profile.

Make an emergency call in flight mode

Enter the emergency number, press the call key, and when **Exit flight profile?** is displayed, select **Yes**.

 **Warning:** With the flight profile you cannot make or receive any calls, including emergency calls, or use other features that require network coverage. To make calls, you must first activate the phone function by changing profiles. If the device has been locked, enter the lock code. If you need to make an emergency call while the device is

locked and in the flight profile, you may be also able to enter an official emergency number programmed in your device in the lock code field and select 'Call'. The device will confirm that you are about to exit flight profile to start an emergency call.

Keypad lock

To lock the keypad to prevent accidental keypresses, select **Menu**, and press * within 3.5 seconds.

To unlock the keypad, select **Unlock**, and press * within 1.5 seconds. If requested, enter the lock code.

To answer a call when the keypad is locked, press the call key. When you end or reject the call, the keypad locks automatically.

Further features are **Automatic keyguard** and **Security keyguard**. [See "Phone", p. 33.](#)

When the device or keypad is locked, calls may be possible to the official emergency number programmed into your device.

Functions without a SIM card

Some functions of your phone may be used without inserting a SIM card, such as Organiser functions and games. Some functions appear dimmed in the menus and cannot be used.

3. Calls

Make a call

You can make a call in several ways:

- Enter the phone number, including the area code, and press the call key.
For international calls, press * twice for the international prefix (the + character replaces the international access code), enter the country code, the area code without the leading 0, if necessary, and the phone number.
- To access the list of dialled numbers, press the call key once in the standby mode. Select a number or name, and press the call key.
- Search for a name or phone number that you saved in Contacts. [See "Manage contacts", p. 27.](#)

To adjust the volume in a call, press the volume key up or down.

Answer and end a call

To answer an incoming call, open the fold and press the call key. To end the call, press the end key, or close the fold.

To reject an incoming call, press the end key. To mute the ringing tone, select **Silence**.

Calls

To answer a call just by opening the fold, select **Menu > Settings > Call > Answ. if fold opened > On**.

Dialling shortcuts

First assign a phone number to one of the number keys, 2 to 9. [See "Assign dialling shortcuts", p. 28.](#)

Use a dialling shortcut to make a call in one of the following ways:

- Press a number key, then the call key.
- If **Menu > Settings > Call > Speed dialling > On** is selected, press and hold a number key.

Voice dialling

Make a phone call by saying the name that is saved in Contacts.

As voice commands are language-dependent, before voice dialling, you must select **Menu > Settings > Phone > Language settings > Phone language** and your language.



Note: Using voice tags may be difficult in a noisy environment or during an emergency, so you should not rely solely upon voice dialling in all circumstances.

1. In the standby mode, press and hold the right selection key. A short tone sounds, and **Speak now** is displayed.
2. Say the name of the contact you want to dial. If the voice recognition is successful, a list with matches is shown. The phone plays the voice command of the first match on the list. If it is not the correct command, scroll to another entry.

Options during a call

Many of the options that you can use during a call are network services. For availability, contact your service provider.

During a call, select **Options**. The available options may include the following:

Call options are **Mute** or **Unmute**, **Contacts**, **Menu**, **Lock keypad**, **Record**, **Voice clarity**, **Loudspeaker** or **Handset**.

Network options are **Answer** or **Reject**, **Hold** or **Unhold**, **New call**, **Add to conference**, **End call**, **End all calls**, and the following:

- **Send DTMF** — to send tone strings
- **Swap** — to switch between the active call and the call on hold
- **Transfer** — to connect a call on hold to an active call and disconnect yourself
- **Conference** — to make a conference call
- **Private call** — to have a private discussion in a conference call





Warning: Do not hold the device near your ear when the loudspeaker is in use, because the volume may be extremely loud.

4. Write text

Text modes

To enter text (for example, when writing messages) you can use traditional or predictive text input.

When you write text, press and hold **Options** to switch between traditional text input, indicated by , and predictive text input, indicated by . Not all languages are supported by predictive text input.

The character cases are indicated by **Abc**, **abc**, and **ABC**.

To change the character case, press **#**. To change from the letter to number mode, indicated by **123**, press and hold **#**, and select **Number mode**. To change from the number to the letter mode, press and hold **#**.

To set the writing language, select **Options** > **Writing language**.

Traditional text input

Press a number key, 2-9, repeatedly until the desired character appears. The available characters depend on the selected writing language.

If the next letter you want is located on the same key as the present one, wait until the cursor appears, and enter the letter.

To access the most common punctuation marks and special characters, press **1** repeatedly. To access the list of special characters, press *****.

Predictive text input

Predictive text input is based on a built-in dictionary to which you can also add new words.

1. Start writing a word, using the keys **2** to **9**. Press each key only once for one letter.
2. To confirm a word, scroll right or add a space.
 - If the word is not correct, press ***** repeatedly, and select the word from the list.
 - If the **?** character is displayed after the word, the word you intended to write is not in the dictionary. To add the word to the dictionary, select **Spell**. Enter the word using traditional text input, and select **Save**.
 - To write compound words, enter the first part of the word, and scroll right to confirm it. Write the last part of the word, and confirm the word.
3. Start writing the next word.

5. Messaging

You can read, write, send and save text and multimedia messages, e-mail, audio and flash messages. The messaging services can only be used if they are supported by your network or service provider.

Text and multimedia messages

You can create a message and optionally attach, for example, a picture. Your phone automatically changes a text message to a multimedia message when a file is attached.

Text messages

Your device supports text messages beyond the limit for a single message. Longer messages are sent as two or more messages. Your service provider may charge accordingly. Characters with accents or other marks, and characters from some language options, take up more space, and limit the number of characters that can be sent in a single message.

An indicator at the top of the display shows the total number of characters left and the number of messages needed for sending.

Before you can send any text or SMS e-mail messages, you must save your message centre number. Select **Menu > Messaging > Message settings > Text messages > Message centres > Add centre**, enter a name, and the number from the service provider.

Multimedia messages

A multimedia message can contain text, pictures, and sound or video clips.

Only devices that have compatible features can receive and display multimedia messages. The appearance of a message may vary depending on the receiving device.

The wireless network may limit the size of MMS messages. If the inserted picture exceeds this limit the device may make it smaller so that it can be sent by MMS.



Important: Exercise caution when opening messages. Messages may contain malicious software or otherwise be harmful to your device or PC.

For availability and subscription to the multimedia messaging service (MMS), contact your service provider. You may also download the configuration settings. [See "Nokia support", p. 10.](#)

Create a text or multimedia message

1. Select **Menu > Messaging > Create message > Message.**

- To add recipients, scroll to the **To:** field, and enter the recipient's number or e-mail address, or select **Add** to select recipients from the available options. Select **Options** to add recipients and subjects and to set sending options.
- Scroll to the **Text:** field, and enter the message text.
- To attach content to the message, scroll to the attachment bar at the bottom of the display and select the desired type of content.
- To send the message, press **Send**.

The message type is indicated at the top of the display and changes automatically depending on the content of the message.

Service providers may charge differently depending on the message type. Check with your service provider for details.

Read a message and reply



Important: Exercise caution when opening messages. Messages may contain malicious software or otherwise be harmful to your device or PC.

Your phone issues a notification when you receive a message. Select **View** to display the message. If more than one message was received, to display a message, select the message from the Inbox and **Open**. Use the scroll key to view all parts of the message.

To create an answer message, select **Reply**.

Send messages

Message sending

To send the message, select **Send**. The phone saves the message in the **Outbox** folder, and the sending starts.



Note: The message sent icon or text on your device screen does not indicate that the message is received at the intended destination.

If message sending is interrupted, the phone tries to resend the message a few times. If these attempts fail, the message remains in the **Outbox** folder. To cancel the sending of the messages in the **Outbox** folder, select **Options** > **Cancel sending**.

To save the sent messages in the **Sent items** folder, select **Menu** > **Messaging** > **Message settings** > **General settings** > **Save sent messages**.

Organise your messages

The phone saves received messages in the **Inbox** folder. Organise your messages in the saved items folder.

To add, rename, or delete a folder, select **Menu** > **Messaging** > **Saved items** > **Options**.

E-mail

Access your POP3 or IMAP4 e-mail account with your phone to read, write and send e-mail. This e-mail application is different from the SMS e-mail function.

Before you can use e-mail, you must have an e-mail account and the correct settings. To check the availability and the settings of your e-mail account, contact your e-mail service provider. You may receive the e-mail configuration settings as a configuration message. [See "Configuration setting service", p. 9.](#)

E-mail setup wizard

The e-mail setup wizard starts automatically if no e-mail settings are defined in the phone. To start the setup wizard for an additional e-mail account, select **Menu** > **Messaging** and the existing e-mail account. Select **Options** > **Add mailbox** to start the e-mail setup wizard. Follow the instructions on the display.

Write and send an e-mail

You may write your e-mail before connecting to the e-mail service.

1. Select **Menu** > **Messaging** > **Create message** > **E-mail message**.
2. If more than one e-mail account is defined, select the account from which you want to send the e-mail.
3. Enter the recipient's e-mail address, the subject, and the e-mail message. To attach a file, select **Options** > **Insert** and from the available options.
4. To send the e-mail, select **Send**.

Read an e-mail and reply



Important: Exercise caution when opening messages. Messages may contain malicious software or otherwise be harmful to your device or PC.

1. To download e-mail message headers, select **Menu** > **Messaging** and your e-mail account.
2. To download an e-mail and its attachments, select the e-mail and **Open** or **Retrieve**.
3. To reply to or forward the e-mail, select **Options** and from the available options.
4. To disconnect from your e-mail account, select **Options** > **Disconnect**. The connection to the e-mail account automatically ends after some time without activity.

New e-mail notifications

Your phone can automatically check your e-mail account in time intervals and issue a notification when new e-mail is received.

1. Select **Menu > Messaging > Message settings > E-mail messages > Edit mailboxes**.
2. Select your e-mail account, **Downloading sett.**, and the following options:
 - **Mailbox upd. interval** — to set how often your phone checks your e-mail account for new e-mail
 - **Automatic retrieval** — to retrieve new e-mail automatically from your e-mail account
3. To enable the new e-mail notification, select **Menu > Messaging > Message settings > E-mail messages > New e-mail notif. > On**.

Flash messages

Flash messages are text messages that are instantly displayed upon reception.

1. To write a flash message, select **Menu > Messaging > Create message > Flash message**.
2. Enter the recipient's phone number, write your message (maximum 70 characters), and select **Send**.

Nokia Xpress audio messages

Create and send an audio message using MMS in a convenient way.

1. Select **Menu > Messaging > Create message > Audio message**. The voice recorder opens.
2. Record your message. [See "Voice recorder", p. 41.](#)
3. Enter one or more phone numbers in the **To:** field, or select **Add** to retrieve a number.
4. To send the message, select **Send**.

Instant messaging

With instant messaging (IM, network service) you can send short text messages to online users. You must subscribe to a service and register with the IM service you want to use. Check the availability of this service, pricing, and instructions with your service provider. The menus may vary depending on your IM provider.

To connect to the service, select **Menu > Messaging > IMs** and follow the instructions on the display.

Info messages, SIM messages, and service commands

Info messages

You can receive messages on various topics from your service provider (network service). For more information, contact your service provider.

Select **Menu > Messaging > Info messages** and from the available options.

Contacts

Service commands

Service commands allow you to write and send service requests (USSD commands) to your service provider, such as activation commands for network services.

To write and send the service request, select **Menu > Messaging > Serv. commands**. For details, contact your service provider.

SIM messages

SIM messages are specific text messages that are saved to your SIM card. You can copy or move those messages from the SIM to the phone memory, but not vice versa.

To read SIM messages, select **Menu > Messaging > Options > SIM messages**.

Voice messages

The voice mailbox is a network service to which you may need to subscribe. For more information, contact your service provider.

To call your voice mailbox, press and hold **1**.

To edit your voice mailbox number, select **Menu > Messaging > Voice messages > Voice mailbox no..**

Message settings

Select **Menu > Messaging > Message settings** and from the following:

- **General settings** — to save copies of sent messages in your phone, to overwrite old messages if the message memory becomes full, and to set up other preferences related to messages
- **Text messages** — to allow delivery reports, to set up message centres for SMS and SMS e-mail, to select the type of character support, and to set up other preferences related to text messages
- **Multimedia messages** — to allow delivery reports, to set up the appearance of multimedia messages, to allow the reception of multimedia messages and advertisements, and to set up other preferences related to multimedia messages
- **E-mail messages** — to allow e-mail reception, to set the image size in e-mail, and to set up other preferences related to e-mail
- **Service messages** — to activate service messages and to set up preferences related to service messages

6. Contacts

You can save names, phone numbers as contacts in the phone memory and on the SIM card memory and search and recall them to make a phone call or to send a message.

Manage contacts

Select the memory for contacts

The phone memory can save contacts with additional details, such as various phone numbers and text items. You can also save an image, a tone, or a video clip for a limited number of contacts.

The SIM card memory can save names with one phone number attached to them. The contacts saved in the SIM card memory are indicated by .

Select **Menu > Contacts > Settings > Memory in use**. When you select **Phone and SIM**, contacts will be saved in the phone memory.

Save names and numbers

To save a name and phone number, select **Menu > Contacts > Add new > Add new contact**.

The first number you save is automatically set as the default number and is indicated with a frame around the number type indicator (for example, ). When you select a name from contacts (for example, to make a call), the default number is used unless you select another number.

Search for a contact

Select **Menu > Contacts > Names**, and scroll through the list of contacts, or enter the first characters of the contact's name.

Add and edit details

To add or change a detail to a contact, select the contact and **Details > Options > Add detail** and from the available options.

Copy or move contacts

1. Select the first contact to copy or move and **Options > Mark**.
2. Mark the other contacts, and select **Options > Copy marked** or **Move marked**.

Copy or move all contacts

Select **Menu > Contacts > Copy contacts** or **Move contacts**.

Delete contacts

Select the contact and **Options > Delete contact**.

To delete all the contacts, select **Menu > Contacts > Del. all contacts > From phone memory** or **From SIM card**.

To delete a number, text item, or an image attached to the contact, search for the contact, and select **Details**. Scroll to the desired detail, select **Options > Delete** and from the available options.

Create a contact group

Arrange contacts into caller groups with different ringing tones and group images.

1. Select **Menu > Contacts > Groups**.

Call log

2. To create a new group, select **Add** or **Options** > **Add new group**.
3. Enter the group name, select an image and a ringing tone if you want to add them to the group, and select **Save**.
4. Select the group and **View** > **Add** to add contacts to the group.

Business cards

You can send and receive a person's contact information from a compatible device that supports the vCard standard.

To send a business card, search for the contact, and select **Details** > **Options** > **Send business card**.

When you receive a business card, select **Show** > **Save** to save the business card in the phone memory.

Assign dialling shortcuts

Create shortcuts by assigning phone numbers to the number keys 2-9.

1. Select **Menu** > **Contacts** > **Speed dials**, and scroll to a number key.
2. Select **Assign**, or, if a number has already been assigned to the key, select **Options** > **Change**.
3. Enter a number or search for a contact.

7. Call log

To view the information on your calls, messages, data, and synchronisation, select **Menu** > **Log** and from the available options.

 **Note:** The actual invoice for calls and services from your service provider may vary, depending on network features, rounding off for billing, taxes, and so forth.

8. Position log

The network may send you a position request (network service). Contact your service provider to subscribe and to agree upon the delivery of positioning information.

To accept or reject the position request, select **Accept** or **Reject**. If you miss the request, the phone automatically accepts or rejects it according to what you have agreed with your network operator or service provider.

To view the information on the 10 most recent privacy notifications and requests, select **Menu** > **Log** > **Positioning** > **Position log**.

9. Connectivity

Your phone provides several features to connect to other devices to transmit and receive data.

Bluetooth wireless technology

Bluetooth technology allows you to connect your phone, using radio waves, to a compatible Bluetooth device within 10 metres (32 feet).

This device is compliant with Bluetooth Specification 2.1 + EDR supporting the following profiles: SIM access, object push, file transfer, dial-up networking, headset, handsfree, generic access, serial port, generic object exchange, advanced audio distribution, audio video remote control, and generic audio/video distribution . To ensure interoperability between other devices supporting Bluetooth technology, use Nokia approved accessories for this model. Check with the manufacturers of other devices to determine their compatibility with this device.

Features using Bluetooth technology increase the demand on battery power and reduce the battery life.

Set up a Bluetooth connection

Select **Menu > Settings > Connectivity > Bluetooth** and take the following steps:

1. Select **My phone's name** and enter a name for your phone.
2. To activate Bluetooth connectivity, select **Bluetooth > On**.  indicates that Bluetooth connectivity is active.
3. To connect your phone to an audio accessory, select **Conn. to audio acc.** and the device that you want to connect to.
4. To pair your phone with any Bluetooth device in range, select **Paired devices > Add new device**.

Scroll to a found device, and select **Add**.

Enter a passcode (up to 16 characters) on your phone and allow the connection on the other Bluetooth device.

If you are concerned about security, turn off the Bluetooth function, or set **My phone's visibility** to **Hidden**. Accept Bluetooth communication only from those you trust.

PC connection to the internet

Use Bluetooth technology to connect your compatible PC to the internet without PC Suite software. Your phone must have activated a service provider that supports internet access, and your PC must support Bluetooth technology. After connecting to the network access point (NAP) service of the phone, and pairing with your PC, your phone automatically opens a packet data connection to the internet.

Packet data

General packet radio service (GPRS) is a network service that allows mobile phones to send and receive data over an internet protocol (IP)-based network.

To define how to use the service, select **Menu** > **Settings** > **Connectivity** > **Packet data** > **Packet data conn.** and from the following options:

- **When needed** — to set the packet data connection to established when required by an application. The connection will be cut when the application is closed.
- **Always online** — to automatically connect to a packet data network when you switch the phone on

You can use your phone as a modem by connecting it to a compatible PC using Bluetooth technology or a USB data cable. For details, see Nokia PC Suite documentation. [See "Nokia support", p. 10.](#)

USB data cable

You can use the USB data cable to transfer data between the phone and a compatible PC or a printer supporting PictBridge.

To activate the phone for data transfer or image printing, connect the data cable, and select the mode:

- **Ask on conn.** — to set your phone to ask whether the connection should be established
- **PC Suite** — to use the cable for PC Suite
- **Printing & media** — to use the phone with a PictBridge compatible printer or with a compatible PC
- **Data storage** — to connect to a PC that does not have Nokia software and use the phone as data storage

To change the USB mode, select **Menu** > **Settings** > **Connectivity** > **USB data cable** and the desired USB mode.

Synchronisation and backup

Select **Menu** > **Settings** > **Sync and backup** and from the following:

- **Backup** — Create a backup of your personal data to a Nokia server. Before you start a backup, you need to set up your My Nokia account. Select **Connect**, and you will be guided through the process.
- **Phone switch** — Synchronise or copy selected data between your phone and another phone using Bluetooth technology.
- **Create backup** — Create a backup of selected data to the memory card or to an external device.
- **Restore backup** — Select a backup file stored on the memory card or on an external device and restore it to the phone. Select **Options** > **Details** for information about the selected backup file.

- **Data transfer** — Synchronise or copy selected data between your phone and another device, PC, or network server (network service).

Nokia PC Suite

With Nokia PC Suite, you can manage your music, synchronise contacts, calendar, notes, and to-do notes between your phone and a compatible PC or a remote internet server (network service). You may find more information and PC Suite on the Nokia website.

[See "Nokia support", p. 10.](#)

10. Settings

Profiles

Your phone has various setting groups called profiles, which you can customise with ringing tones for different events and environments.

Select **Menu** > **Settings** > **Profiles**, the desired profile, and from the following options:

- **Activate** — to activate the selected profile
- **Personalise** — to change the profile settings
- **Timed** — to set the profile to be active for a certain time. When the time set for the profile expires, the previous profile that was not timed becomes active.

Themes

A theme contains elements for personalising your phone.

Select **Menu** > **Settings** > **Themes** and from the following options:

- **Select theme** — Open the **Themes** folder, and select a theme.
- **Theme downloads** — Open a list of links to download more themes.

Tones

You can change the tone settings of the selected active profile.

Select **Menu** > **Settings** > **Tones**. You can find the same settings in the **Profiles** menu.

If you select the highest ringing tone level, the ringing tone reaches its highest level after a few seconds.

Lights

To activate or deactivate light effects associated with different phone functions, select **Menu** > **Settings** > **Lights**.

Display

Select **Menu** > **Settings** > **Display** and from the following:

- **Wallpaper** — to add a background image for the standby mode
- **Home screen** — to activate, organise, and personalise the home screen mode
- **Standby font colour** — to select the font colour for the home screen mode
- **Navigation key icons** — to display the icons of the scroll key shortcuts in the standby mode when the home screen mode is off
- **Notification details** — to display details in missed call and message notifications
- **Fold animation** — to display an animation and sound a tone when you open or close the fold
- **Font size** — to set the font size for messaging, contacts, and web pages
- **Operator logo** — to display the operator logo
- **Cell info display** — to display the cell identity, if available from the network

Date and time

To change the clock type, time, time zone, or date, select **Menu** > **Settings** > **Date and time**.

When travelling to a different time zone, select **Menu** > **Settings** > **Date and time** > **Date & time settings** > **Time zone**, and scroll left or right to select the time zone of your location. The time and date are set according to the time zone and enable your phone to display the correct sending time of received text or multimedia messages.

For example, GMT -5 denotes the time zone for New York (USA), 5 hours west of Greenwich, London (UK).

My shortcuts

With personal shortcuts you get quick access to often used functions of the phone.

Left and right selection keys

To change the function assigned to the left or right selection key, select **Menu** > **Settings** > **My shortcuts** > **Left selection key** or **Right selection key** and the function.

In the standby mode, if the left selection key is **Go to**, to activate a function, select **Go to** > **Options** and from the following options:

- **Select options** — to add or remove a function
- **Organise** — to rearrange the functions

Other shortcuts

Select **Menu** > **Settings** > **My shortcuts** and from the following:

- **Navigation key** — to assign other functions from a predefined list to the navigation key (scroll key).

- **Home screen key** — to select the movement of the navigation key to activate the home screen mode

Call

Select **Menu** > **Settings** > **Call** and from the following:

- **Call divert** — to divert your incoming calls (network service). You may not be able to divert your calls if some call barring functions are active. [See "Security", p. 35.](#)
- **Anykey answer** — to answer an incoming call by briefly pressing any key, except the power key, the left and right selection keys, or the end key
- **Automatic redial** — to automatically redial the number if a call fails. The phone tries to call the number 10 times.
- **Voice clarity** — to enhance speech intelligibility, especially in noisy environments
- **Speed dialling** — to dial the names and phone numbers assigned to the number keys (2-9) by pressing and holding the corresponding number key
- **Call waiting** — to have the network notify you of an incoming call while you have a call in progress (network service)
- **Call duration display** — to display the duration of the call in progress
- **Summary after call** — to briefly display the approximate duration after each call
- **Send my caller ID** — to show your phone number to the person you are calling (network service). To use the setting agreed upon with your service provider, select **Set by network**.
- **Outgoing call line** — to select the phone line for making calls, if your SIM card supports multiple phone lines (network service)
- **Answ. if fold opened** — to answer or end a call by opening or closing the fold

Phone

Select **Menu** > **Settings** > **Phone** and from the following:

- **Language settings** — to set the language of your phone, select **Phone language** and a language. To set the language of your phone according to the information on the SIM card, select **Phone language** > **Automatic**.
- **Memory status** — to check the memory consumption
- **Automatic keyguard** — to lock the keypad automatically after a preset time delay when the phone is in the standby mode and no function has been used
- **Security keyguard** — to ask for the security code when you unlock the keyguard
- **Voice recognition** — [See "Voice commands", p. 34.](#)
- **Flight query** — to be asked whether to use the flight mode when you switch the phone on. With the flight mode, all radio connections are switched off.
- **Phone updates** — to receive software updates from your service provider (network service). This option may not be available, depending on your phone. [See "Software updates over the air", p. 35.](#)
- **Operator selection** — to set a cellular network available in your area
- **Help text activation** — to select whether the phone shows help texts
- **Start-up tone** — to play a tone when you switch the phone on

Settings

- **Fold close handling** — to select the behaviour of the phone when the fold is closed
- **Confirm SIM actions** — (network service) [See "SIM services", p. 49.](#)

Voice commands

Call contacts and use your phone by speaking a voice command.

Voice commands are language-dependent. To set the language, select **Menu > Settings > Phone > Language settings > Phone language** and your language.

To train the voice recognition of your phone to your voice, select **Menu > Settings > Phone > Voice recognition > Voice recog. training**.

To activate a voice command for a function, select **Menu > Settings > Phone > Voice recognition > Voice commands**, a feature, and the function.  indicates that the voice command is activated.

To activate the voice command, select **Add**. To play the activated voice command, select **Play**.

To use voice commands, see ["Voice dialling", p. 20.](#)

To manage the voice commands, scroll to a function, and select **Options** and from the following:

- **Edit** or **Remove** — to rename or deactivate the voice command
- **Add all** or **Remove all** — to activate or deactivate voice commands for all functions in the voice commands list

Accessories

This menu and its various options are shown only if the phone is or has been connected to a compatible mobile accessory.

Select **Menu > Settings > Accessories**. Select an accessory, and an option depending on the accessory.

Configuration

You can configure your phone with settings that are required for certain services. Your service provider may also send you these settings. [See "Configuration setting service", p. 9.](#)

Select **Menu > Settings > Configuration** and from the following options:

- **Default config. sett.** — to view the service providers saved in the phone and set a default service provider
- **Act. def. in all apps.** — to activate the default configuration settings for supported applications
- **Preferred access pt.** — to view the saved access points
- **Connect to support** — to download the configuration settings from your service provider

- **Device manager sett.** — to allow or prevent the phone from receiving software updates. This option may not be available, depending on your phone. [See "Software updates over the air", p. 35.](#)
- **Personal config. sett.** — to manually add new personal accounts for various services and to activate or delete them. To add a new personal account, select **Add**, or **Options** > **Add new**. Select the service type, and enter the required parameters. To activate a personal account, scroll to it, and select **Options** > **Activate**.

Software updates over the air

Your service provider may send phone software updates over the air directly to your phone (network service). This option may not be available, depending on your phone.

Downloading software updates may involve the transmission of large amounts of data through your service provider's network. Contact your service provider for information about data transmission charges.

Make sure that the device battery has enough power, or connect the charger before starting the update.



Warning: If you install a software update, you cannot use the device, even to make emergency calls, until the installation is completed and the device is restarted. Be sure to back up data before accepting installation of an update.

Software update settings

This option may not be available, depending on your phone.

To allow or disallow software and configuration updates, select **Menu** > **Settings** > **Configuration** > **Device manager sett.** > **Serv. softw. updates**.

Request a software update

1. Select **Menu** > **Settings** > **Phone** > **Phone updates** to request available software updates from your service provider.
2. Select **Current softw. details** to display the current software version and check whether an update is needed.
3. Select **Downl. phone softw.** to download and install a software update. Follow the instructions on the display.
4. If the installation was cancelled after the download, select **Install softw. update** to start the installation.

The software update may take several minutes. If there are problems with the installation, contact your service provider.

Security

When security features that restrict calls are in use (such as call barring, closed user group, and fixed dialling), calls may be possible to the official emergency number programmed into your device.

Operator menu

Select **Menu** > **Settings** > **Security** and from the following:

- **PIN code request** or **UPIN code request** — to request for your PIN or UPIN code every time the phone is switched on. Some SIM cards do not allow the code request to be turned off.
- **Call barring service** — to restrict incoming calls to and outgoing calls from your phone (network service). A barring password is required.
- **Fixed dialling** — to restrict your outgoing calls to selected phone numbers if supported by your SIM card. When the fixed dialling is on, GPRS connections are not possible except while sending text messages over a GPRS connection. In this case, the recipient's phone number and the message centre number must be included in the fixed dialling list.
- **Closed user group** — to specify a group of people whom you can call and who can call you (network service)
- **Security level** — to request the security code whenever a new SIM card is inserted into the phone, select **Phone**. To request the security code when the SIM card memory is selected, and you want to change the memory in use, select **Memory**.
- **Access codes** — to change the security code, PIN code, UPIN code, PIN2 code, or barring password
- **PIN2 code request** — to select whether the PIN2 code is required when using a specific phone feature which is protected by the PIN2 code. Some SIM cards do not allow the code request to be turned off.
- **Code in use** — to select the type of PIN code
- **Authority certificates** or **User certificates** — to view the list of the authority or user certificates downloaded into your phone. [See "Browser security", p. 48.](#)
- **Security module sett.** — to view **Secur. module details**, activate **Module PIN request**, or change the module PIN and signing PIN. [See "Access codes", p. 8.](#)

Restore factory settings

To restore the phone back to factory conditions, select **Menu** > **Settings** > **Rest. factory sett.** and from the following:

- **Restore settings only** — Reset all preference settings without deleting any personal data.
- **Restore all** — Reset all preference settings and delete all personal data, such as contacts, messages, media files, and activation keys.

11. Operator menu

Access a portal to services provided by your network operator. For more information, contact your network operator. The operator can update this menu with a service message.

12. Gallery

Manage images, video clips, music files, themes, graphics, tones, recordings, and received files. These files are stored in the phone memory or on a memory card and may be arranged in folders.

Folders and files

To view the list of folders, select **Menu** > **Gallery**. To view the list of files in a folder, select a folder and **Open**. To view the folders of the memory card when moving a file, scroll to the memory card, and press the scroll key right.

Print images

Your phone supports Nokia XpressPrint to print images that are in the jpeg format.

1. To connect your phone to a compatible printer, use a data cable or send the image by Bluetooth to a printer supporting Bluetooth technology. [See "Bluetooth wireless technology", p. 29.](#)
2. Select the image you want to print and **Options** > **Print**.

Share images and videos online

Share images and video clips in compatible online sharing services on the web.

To use online sharing, you must subscribe to an online sharing service (network service).

To upload an image or a video clip to an online sharing service, select the file from Gallery, **Options** > **Send** > **Upload to web**, and an online sharing service.

For more information on online sharing and compatible service providers, see the Nokia product support pages or your local Nokia website.

You can view uploads on the internet pages of the online sharing service on your device. [See "Web uploads", p. 47.](#)

Memory card

Use a memory card to store your multimedia files, such as video clips, music tracks, sound files, images, and messaging data.

Some of the folders in **Gallery** with content that the phone uses (for example, **Themes**) may be stored on the memory card.

Format the memory card

Some supplied memory cards are preformatted; others require formatting. When you format a memory card, all data on the card is permanently lost.

1. To format a memory card, select **Menu** > **Gallery** or **Applications**, the memory card folder , and **Options** > **Format memory card** > **Yes**.

Media

2. When formatting is complete, enter a name for the memory card.

Lock the memory card

To set a password (maximum 8 characters) to lock your memory card against unauthorised use, select the memory card folder  and **Options > Set password**.

The password is stored in your phone, and you do not have to enter it again while you are using the memory card on the same phone. If you want to use the memory card on another device, you are asked for the password.

To remove the password, select **Options > Delete password**.

Check memory consumption

To check the memory consumption of different data groups and the available memory to install new software on your memory card, select the memory card  and **Options > Details**.

13. Media

Camera and video

Take pictures or record video clips with the built-in camera.

Take a picture

To use the still picture function, select **Menu > Media > Camera**; or, if the video function is on, scroll left or right.

To zoom in and out in the camera mode, scroll up and down, or press the volume keys.

To take a picture, select **Capture**. The phone saves the pictures on the memory card, if available, or in the phone memory.

Keep a safe distance when using the flash. Do not use the flash on people or animals at close range. Do not cover the flash while taking a picture.

To take all pictures with the camera flash, select **Options > Flash > Flash on**; or to activate the flash automatically when the light conditions are dim, select **Automatic**.

To display a picture immediately after you take it, select **Options > Settings > Image preview time** and the preview time. During the preview time, to take another picture, select **Back**, or to send the picture to another device or to an available service, select **Options > Send** and from the available options.

Your device supports an image capture resolution of up to 1600x1200 pixels .

Record a video clip

To activate the video function, select **Menu > Media > Video**; or, if the camera function is on, scroll left or right.

To start the video recording, select **Record**; to pause the recording, select **Pause**; to resume the recording, select **Continue**; to stop the recording, select **Stop**.

Your device supports a video resolution of 176x144 pixels and saves the video clips on the memory card, if available, or in the phone memory.

Camera and video options

To use a filter, select **Options** > **Effects**.

To adapt the camera to the light conditions, select **Options** > **White balance**.

To change other camera and video settings and to select the image and video storage, select **Options** > **Settings**.

Media player

Your phone includes a media player for listening songs and viewing video clips. Music and video files stored in the music folder in the phone memory or on the memory card are automatically detected and added to the music library.

To open the media player, select **Menu** > **Media** > **Media player**.

Music menu

Access your music and video files stored in the phone memory or on the memory card, download music or video clips from the web, or view compatible video streams from a network server (network service).

To listen to music or play a video clip, select a file from the available folders and **Play**.

To download files from the web, select **Options** > **Downloads** and a download site.

To update the music library after you have added files, select **Options** > **Update library**.

Create a playlist

To create a playlist with your selection of music, do the following:

1. Select **Playlists** > **Create playlist**, and enter the name of the playlist.
2. Add music or video clips from the displayed lists.
3. Select **Done** to store the playlist.

Configure a streaming service

You may receive the streaming settings as a configuration message from the service provider. See "[Configuration setting service](#)", p. 9. You can also enter the settings manually. See "[Configuration](#)", p. 34.

To activate the settings, do the following:

1. Select **Options** > **Downloads** > **Streaming settings** > **Configuration**.
2. Select a service provider, **Default**, or **Personal config**, for streaming.
3. Select **Account** and a streaming service account from the active configuration settings.

Play songs





Warning: Listen to music at a moderate level. Continuous exposure to high volume may damage your hearing. Do not hold the device near your ear when the loudspeaker is in use, because the volume may be extremely loud.



To adjust the volume level, press the volume keys.

Operate the player with the virtual keys on the display.

To start playing, select .

To pause playing, select .

To skip to the next song, select . To skip to the beginning of the previous song, select  twice.

To fast-forward the current song, select and hold . To rewind the current song, select and hold . Release the key at the position you want to continue the music playback.

To switch to the music menu, select  on the display.

To switch to the current playlist, select  on the display.

To close the media player menu, and to continue music playback in the background, press the end key.

To stop the media player, press and hold the end key.

Change the media player look

Your phone provides several themes to change the look of the media player.

Select **Menu > Media > Media player > Go to Media player > Options > Settings > Media player theme** and one of the listed themes. The virtual keys may change depending on the theme.

Radio

The FM radio depends on an antenna other than the wireless device antenna. A compatible headset or enhancement needs to be attached to the device for the FM radio to function properly.



Warning: Listen to music at a moderate level. Continuous exposure to high volume may damage your hearing. Do not hold the device near your ear when the loudspeaker is in use, because the volume may be extremely loud.

Select **Menu > Media > Radio**.





To adjust the volume level, press the volume keys of the phone.

To use the graphical keys on the display, scroll up, down, left, or right.

To switch the radio off, press and hold the end key.

Tune in to radio stations



Search and save stations

1. To start the search, select and hold  or . To change the radio frequency in 0.05 MHz steps, briefly press  or .
2. To save a station to a memory location, select **Options** > **Save station**.
3. To enter the name of the radio station, select **Options** > **Stations** > **Options** > **Rename**.

Select **Options** and from the following:

- **Search all stations** — to automatically search for the available stations at your location
- **Set frequency** — to enter the frequency of the desired radio station
- **Station directory** — to access a website with a list of radio stations
- **Stations** — to list, organise, rename, or delete saved stations

Change stations

Select  or , or press the number key corresponding to the number of the station in the station list.

Radio settings

Select **Options** > **Settings** and from the following:

- **RDS** — to select whether to display information from the radio data system
- **Auto-frequency** — to enable the automatic switch to a frequency with the best reception of the tuned in station (available with activated RDS)
- **Play via** — to select the headset or the loudspeaker
- **Output** — to switch between stereo and mono output
- **Radio theme** — to select a radio theme

Visual Radio

Some radio stations may send text or graphical information that you can view using the Visual Radio application (network service). For availability and costs, contact your service provider.

To set the visual service ID of a station, select **Options** > **Stations** and a station. Select **Options** > **Visual service ID**, and enter the ID.



To start Visual Radio, select **Options** > **Visual Radio**.

To start Visual Radio automatically or after confirmation when you turn on the radio, select **Options** > **Enable visual serv..**



Voice recorder

Record speech, sound, or an active call, and save them in **Gallery**.

Organiser

Select **Menu** > **Media** > **Voice recorder**. To use the graphical keys , , or  on the display, scroll left or right.

Record sound

1. Select , or, during a call, select **Options** > **Record**. While recording a call, all parties to the call hear a faint beeping. To pause the recording, select .
2. To end the recording, select . The recording is saved in the Recordings folder in Gallery.

Select **Options** to play or send the last recording, to access the list of recordings, or to select the memory and the folder to store the recordings.

Equaliser

Adjust the sound when using the music player.

Select **Menu** > **Media** > **Equaliser**.

To activate a predefined equaliser set, scroll to one of the sets, and select **Activate**.

Create a new equaliser set

1. Select one of the last two sets in the list and **Options** > **Edit**.
2. Scroll left or right to access the virtual sliders and up or down to adjust the slider.
3. To save the settings and create a name for the set, select **Save** and **Options** > **Rename**.

Stereo widening

Stereo widening creates a wider stereo sound effect when you are using a stereo headset.

To activate, select **Menu** > **Media** > **Stereo widening**.

14. Organiser

Alarm clock

To sound an alarm at a desired time.

Set the alarm

1. Select **Menu** > **Organiser** > **Alarm clock**.
2. Set the alarm on, and enter the alarm time.
3. To issue an alarm on selected days of the week, select **Repeat:** > **On** and the days.
4. Select the alarm tone. If you select the radio as the alarm tone, connect the headset to the phone.
5. Set the snooze time-out, and select **Save**.

Stop the alarm

To stop the sounding alarm, select **Stop**. If you let the alarm sound for a minute or select **Snooze**, the alarm stops for the snooze time-out, then resumes.

Calendar

Select **Menu** > **Organiser** > **Calendar**.

The current day is framed. If there are any notes set for the day, the day is in bold type. To view the day notes, select **View**. To view a week, select **Options** > **Week view**. To delete all notes in the calendar, select **Options** > **Delete notes** > **All notes**.

To edit settings related to date and time, select **Options** > **Settings** and from the available options. To delete old notes automatically after a specified time, select **Options** > **Settings** > **Auto-delete notes** and from the available options.

Make a calendar note

Scroll to the date, and select **Options** > **Make a note**. Select the note type, and fill in the fields.

Maps

You can browse maps for different cities and countries, search for addresses and points of interest, plan routes from one location to another, save locations as landmarks, and send them to compatible devices.

Almost all digital cartography is inaccurate and incomplete to some extent. Never rely solely on the cartography that you download for use in this device.

To use the Maps application, select **Menu** > **Organiser** > **Maps** and from the available options.

Download maps

Your phone may contain pre-installed maps on the memory card. You can download a new set of maps through the internet using the Nokia Map Loader PC software.

Nokia Map Loader

To download the Nokia Map Loader on your PC and for further instructions, see www.maps.nokia.com.

Before you download new maps for the first time, ensure that you have a memory card inserted in the phone.

Select **Menu** > **Organiser** > **Maps** to do an initial configuration.

To change the selection of maps on your memory card, use the Nokia Map Loader to delete all maps on the memory card and download a new selection, to ensure that all maps are from the same release.

Organiser

Network map service

You can set your phone to automatically download maps that you do not have in your phone when needed.

Select **Menu > Organiser > Maps > Settings > Network settings > Allow network usage > Yes** or **In home network**.

To prevent automatic download of maps, select **No**.

Downloading maps may involve the transmission of large amounts of data through your service provider's network. Contact your service provider for information about data transmission charges.

Maps and GPS

You can use the global positioning system (GPS) to support the Maps application. Find out your location, or measure distances and coordinates.

Before you can use the GPS function with your phone, you must pair your phone with a compatible external GPS receiver using Bluetooth wireless technology. For more information, see the user guide for your GPS device.

After pairing the Bluetooth GPS device with the phone, it may take several minutes for the phone to display the current location. Subsequent connections should be faster, but if you have not used GPS for several days, or are very far away from the last place you used it, it may take several minutes to detect and display your location.

The Global Positioning System (GPS) is operated by the government of the United States, which is solely responsible for its accuracy and maintenance. The accuracy of location data can be affected by adjustments to GPS satellites made by the United States government and is subject to change with the United States Department of Defense civil GPS policy and the Federal Radionavigation Plan. Accuracy can also be affected by poor satellite geometry. Availability and quality of GPS signals may be affected by your location, buildings, natural obstacles, and weather conditions. The GPS receiver should only be used outdoors to allow reception of GPS signals.

Any GPS should not be used for precise location measurement, and you should never rely solely on location data from the GPS receiver and cellular radio networks for positioning or navigation.

Extra services

You can upgrade Maps with a full voice-guided navigation, which requires a regional licence. To use this service, you need a compatible external GPS device that supports Bluetooth wireless technology.

To purchase a navigation service with voice guidance, select **Menu > Organiser > Maps > Extra services > Purchase navigation**, and follow the instructions.

To use navigation with voice guidance, you must allow the Maps application to use a network connection.

The navigation licence is connected to your SIM card. If you insert another SIM card in your phone, you are asked to purchase a licence when starting navigation. During the purchase procedure, you are offered to transfer the existing navigation licence to the new SIM card without extra charge.

To-do list

To save a note for a task that you must do, select **Menu > Organiser > To-do list**.

To make a note if no note is added, select **Add**; otherwise, select **Options > Add**. Fill in the fields, and select **Save**.

To view a note, scroll to it, and select **View**.

Notes

To write and send notes, select **Menu > Organiser > Notes**.

To make a note if no note is added, select **Add**; otherwise, select **Options > Make a note**. Write the note, and select **Save**.

Calculator

Your phone provides a standard, a scientific, and a loan calculator.

Select **Menu > Organiser > Calculator** and, from the available options, the calculator type and the operating instructions.

This calculator has limited accuracy and is designed for simple calculations.

Countdown timer

Normal timer

1. To activate the timer, select **Menu > Organiser > Countd. timer > Normal timer**, enter a time, and write a note that is displayed when the time expires. To change the time, select **Change time**.
2. To start the timer, select **Start**.
3. To stop the timer, select **Stop timer**.

Interval timer

1. To have an interval timer with up to 10 intervals started, first enter the intervals.
2. Select **Menu > Organiser > Countd. timer > Interval timer**.
3. To start the timer, select **Start timer > Start**.

To select how the interval timer should start the next period, select **Menu > Organiser > Countd. timer > Settings > Contin. to next period** and from the available options.

Stopwatch

You can measure time, take intermediate times, or take lap times using the stopwatch. Select **Menu > Organiser > Stopwatch** and from the following options:

- **Split timing** — to take intermediate times. To reset the time without saving it, select **Options > Reset**.
- **Lap timing** — to take lap times
- **Continue** — to view the timing that you have set in the background
- **Show last** — to view the most recently measured time if the stopwatch is not reset
- **View times** or **Delete times** — to view or delete the saved times

To set the stopwatch timing in the background, press the end key.

15. Applications

Your phone may have some games or applications installed. These files are stored in the phone memory or on a memory card and may be arranged in folders. [See "Memory card", p. 37.](#)

Launch an application

Select **Menu > Applications > Games, Memory card, or Collection**. Scroll to a game or an application, and select **Open**.

To set sounds, lights, and shakes for a game, select **Menu > Applications > Options > Application settings**.

Other available options may include the following:

- **Update version** — to verify that a new version of the application is available for download from the web (network service)
- **Web page** — to provide further information or additional data for the application from an internet page (network service), if available
- **Application access** — to restrict the application from accessing the network

Download an application

Your phone supports J2ME Java applications. Ensure that the application is compatible with your phone before downloading it.



Important: Only install and use applications and other software from trusted sources, such as applications that are Symbian Signed or have passed the Java Verified™ testing.

You can download new applications and games in different ways.

- Select **Menu > Applications > Options > Downloads > App. downloads** or **Game downloads**; the list of available bookmarks is shown.

- Use the Nokia Application Installer from PC Suite to download the applications to your phone.

For the availability of different services and pricing, contact your service provider.

16. Web

You can access various internet services with your phone browser. The appearance of the internet pages may vary due to screen size. You may not be able to see all the details on the internet pages.



Important: Use only services that you trust and that offer adequate security and protection against harmful software.

For the availability of these services, pricing, and instructions, contact your service provider.

You may receive the configuration settings required for browsing as a configuration message from your service provider.

To set up the service, select **Menu > Web > Web settings > Configuration sett.**, a configuration, and an account.

Connect to a service

To make a connection to the service, select **Menu > Web > Home**; or in the standby mode, press and hold **0**.

To select a bookmark, select **Menu > Web > Bookmarks**.

To select the last URL, select **Menu > Web > Last web addr.**

To enter an address of a service, select **Menu > Web > Go to address**. Enter the address, and select **OK**.

After you make a connection to the service, you can start browsing its pages. The function of the phone keys may vary in different services. Follow the text guides on the phone display. For more information, contact your service provider.

Web uploads

Open the web page of your online sharing service to view uploaded images and videos and to change settings (network service).

Open an online sharing service

1. Select **Menu > Web > Web uploads** and an online sharing service.
2. Select from the links offered by the service.

Web

Add a new online sharing service

Select **Menu** > **Web** > **Web uploads** > **Add new service** and follow the instructions on the display.

Change settings of an online sharing service

1. Select **Menu** > **Web** > **Web uploads** and an online sharing service.
2. Select **Options** > **Settings** to open the settings page of the service.

Appearance settings

While browsing the web, select **Options** > **Settings**. The available options may include the following:

- **Display** — Select the font size, whether images are shown, and how the text is displayed.
- **General** — Select whether web addresses are sent as Unicode (UTF-8), the encoding type for the contents, and whether JavaScript is enabled.

Cache memory

A cache is a memory location that is used to store data temporarily. If you have tried to access or have accessed confidential information requiring passwords, empty the cache after each use. The information or services you have accessed are stored in the cache.

A cookie is data that a site saves in the cache memory of your phone. Cookies are saved until you clear the cache memory.

To clear the cache while browsing, select **Options** > **Tools** > **Clear the cache**. To allow or prevent the phone from receiving cookies, select **Menu** > **Web** > **Web settings** > **Security** > **Cookies**; or, while browsing, select **Options** > **Settings** > **Security** > **Cookies**.

Browser security

Security features may be required for some services, such as banking services or online shopping. For such connections you need security certificates and possibly a security module which may be available on your SIM card. For more information, contact your service provider.

To view or change the security module settings, or to view a list of authority or user certificates downloaded to your phone, select **Menu** > **Settings** > **Security** > **Security module sett.**, **Authority certificates**, or **User certificates**.



Important: Even if the use of certificates makes the risks involved in remote connections and software installation considerably smaller, they must be used correctly in order to benefit from increased security. The existence of a certificate does not offer any protection by itself; the certificate manager must contain correct, authentic, or trusted certificates for increased security to be available. Certificates have a restricted

lifetime. If "Expired certificate" or "Certificate not valid yet" is shown, even if the certificate should be valid, check that the current date and time in your device are correct.

17. SIM services

Your SIM card may provide additional services. You can access this menu only if it is supported by your SIM card. The name and contents of the menu depend on the available services.

To show the confirmation messages sent between your phone and the network when you are using the SIM services, select **Menu > Settings > Phone > Confirm SIM actions**.

Accessing these services may involve sending messages or making a phone call for which you may be charged.

Enhancements



Warning: Use only batteries, chargers, and enhancements approved by Nokia for use with this particular model. The use of any other types may invalidate any approval or warranty, and may be dangerous.

For availability of approved enhancements, please check with your dealer. When you disconnect the power cord of any enhancement, grasp and pull the plug, not the cord.

Battery

Battery and charger information

Your device is powered by a rechargeable battery. The battery intended for use with this device is BL-5BT. This device is intended for use when supplied with power from the following chargers: AC-3. The battery can be charged and discharged hundreds of times, but it will eventually wear out. When the talk and standby times are noticeably shorter than normal, replace the battery. Use only Nokia approved batteries, and recharge your battery only with Nokia approved chargers designated for this device. Use of an unapproved battery or charger may present a risk of fire, explosion, leakage, or other hazard.

The exact charger model number may vary depending on the type of plug. The plug variant is identified by one of the following: E, EB, X, AR, U, A, C, or UB.

If a battery is being used for the first time or if the battery has not been used for a prolonged period, it may be necessary to connect the charger, then disconnect and reconnect it to begin charging the battery. If the battery is completely discharged, it may take several minutes before the charging indicator appears on the display or before any calls can be made.

Always switch the device off and disconnect the charger before removing the battery.

Unplug the charger from the electrical plug and the device when not in use. Do not leave a fully charged battery connected to a charger, since overcharging may shorten its lifetime. If left unused, a fully charged battery will lose its charge over time.

Always try to keep the battery between 15°C and 25°C (59°F and 77°F). Extreme temperatures reduce the capacity and lifetime of the battery. A device with a hot or cold battery may not work temporarily. Battery performance is particularly limited in temperatures well below freezing.

Do not short-circuit the battery. Accidental short-circuiting can occur when a metallic object such as a coin, clip, or pen causes direct connection of the positive (+) and negative (-) terminals of the battery. (These look like metal strips on the battery.) This might happen, for example, when you carry a spare battery in your pocket or purse. Short-circuiting the terminals may damage the battery or the connecting object.

Do not dispose of batteries in a fire as they may explode. Batteries may also explode if damaged. Dispose of batteries according to local regulations. Please recycle when possible. Do not dispose as household waste.

Do not dismantle, cut, open, crush, bend, deform, puncture, or shred cells or batteries. In the event of a battery leak, do not allow the liquid to come in contact with the skin or eyes. In the event of such a leak, flush your skin or eyes immediately with water, or seek medical help.

Do not modify, remanufacture, attempt to insert foreign objects into the battery, or immerse or expose it to water or other liquids.

Improper battery use may result in a fire, explosion, or other hazard. If the device or battery is dropped, especially on a hard surface, and you believe the battery has been damaged, take it to a service centre for inspection before continuing to use it.

Use the battery only for its intended purpose. Never use any charger or battery that is damaged. Keep your battery out of the reach of small children.

Nokia battery authentication guidelines

Always use original Nokia batteries for your safety. To check that you are getting an original Nokia battery, purchase it from an authorised Nokia dealer, and inspect the hologram label using the following steps:

Successful completion of the steps is not a total assurance of the authenticity of the battery. If you have any reason to believe that your battery is not an authentic, original Nokia battery, you should refrain from using it, and take it to the nearest authorised Nokia service point or dealer for assistance. Your authorised Nokia service point or dealer will inspect the battery for authenticity. If authenticity cannot be verified, return the battery to the place of purchase.

Authenticate hologram

1. When you look at the hologram on the label, you should see the Nokia connecting hands symbol from one angle and the Nokia Original Enhancements logo when looking from another angle.



Care and maintenance

- When you angle the hologram left, right, down and up, you should see 1, 2, 3 and 4 dots on each side respectively.



What if your battery is not authentic?

If you cannot confirm that your Nokia battery with the hologram on the label is an authentic Nokia battery, please do not use the battery. Take it to the nearest authorised Nokia service point or dealer for assistance. The use of a battery that is not approved by the manufacturer may be dangerous and may result in poor performance and damage to your device and its enhancements. It may also invalidate any approval or warranty applying to the device.

To find out more about original Nokia batteries, visit www.nokia.com/battery.

Care and maintenance

Your device is a product of superior design and craftsmanship and should be treated with care. The following suggestions will help you protect your warranty coverage.

- Keep the device dry. Precipitation, humidity, and all types of liquids or moisture can contain minerals that will corrode electronic circuits. If your device does get wet, remove the battery, and allow the device to dry completely before replacing it.
- Do not use or store the device in dusty, dirty areas. Its moving parts and electronic components can be damaged.
- Do not store the device in hot areas. High temperatures can shorten the life of electronic devices, damage batteries, and warp or melt certain plastics.
- Do not store the device in cold areas. When the device returns to its normal temperature, moisture can form inside the device and damage electronic circuit boards.
- Do not attempt to open the device other than as instructed in this guide.
- Do not drop, knock, or shake the device. Rough handling can break internal circuit boards and fine mechanics.
- Do not use harsh chemicals, cleaning solvents, or strong detergents to clean the device.
- Do not paint the device. Paint can clog the moving parts and prevent proper operation.
- Use a soft, clean, dry cloth to clean any lenses, such as camera, proximity sensor, and light sensor lenses.

- Use only the supplied or an approved replacement antenna. Unauthorised antennas, modifications, or attachments could damage the device and may violate regulations governing radio devices.
- Use chargers indoors.
- Always create a backup of data you want to keep, such as contacts and calendar notes.
- To reset the device from time to time for optimum performance, power off the device and remove the battery.

These suggestions apply equally to your device, battery, charger, or any enhancement. If any device is not working properly, take it to the nearest authorised service facility for service.

Disposal

 The crossed-out wheeled-bin symbol on your product, literature, or packaging reminds you that all electrical and electronic products, batteries, and accumulators must be taken to separate collection at the end of their working life. This requirement applies to the European Union and other locations where separate collection systems are available. Do not dispose of these products as unsorted municipal waste.

By returning the products to collection you help prevent uncontrolled waste disposal and promote the reuse of material resources. More detailed information is available from the product retailer, local waste authorities, national producer responsibility organizations, or your local Nokia representative. For the product Eco-Declaration or instructions for returning your obsolete product, go to country-specific information at www.nokia.com.

Additional safety information

Small children

Your device and its enhancements may contain small parts. Keep them out of the reach of small children.

Operating environment

This device meets RF exposure guidelines when used either in the normal use position against the ear or when positioned at least 2.2 centimetres (7/8 inch) away from the body. When a carry case, belt clip, or holder is used for body-worn operation, it should not contain metal and should position the device the above-stated distance from your body.

To transmit data files or messages, this device requires a quality connection to the network. In some cases, transmission of data files or messages may be delayed until such a connection is available. Ensure the above separation distance instructions are followed until the transmission is completed.

Medical devices

Operation of any radio transmitting equipment, including wireless phones, may interfere with the functionality of inadequately protected medical devices. Consult a physician or the manufacturer of the medical device to determine if they are adequately shielded from external RF energy or if you have any questions. Switch off your device in health care facilities when any regulations posted in these areas instruct you to do so. Hospitals or health care facilities may be using equipment that could be sensitive to external RF energy.

Implanted medical devices

Manufacturers of medical devices recommend that a minimum separation of 15.3 centimetres (6 inches) should be maintained between a wireless device and an implanted medical device, such as a pacemaker or implanted cardioverter defibrillator, to avoid potential interference with the medical device. Persons who have such devices should:

- Always keep the wireless device more than 15.3 centimetres (6 inches) from the medical device when the wireless device is turned on.
- Not carry the wireless device in a breast pocket.
- Hold the wireless device to the ear opposite the medical device to minimise the potential for interference.
- Turn the wireless device off immediately if there is any reason to suspect that interference is taking place.
- Read and follow the directions from the manufacturer of their implanted medical device.

If you have any questions about using your wireless device with an implanted medical device, consult your health care provider.

Hearing aids

Some digital wireless devices may interfere with some hearing aids. If interference occurs, consult your service provider.

Vehicles

RF signals may affect improperly installed or inadequately shielded electronic systems in motor vehicles such as electronic fuel injection systems, electronic antiskid (antilock) braking systems, electronic speed control systems, and air bag systems. For more information, check with the manufacturer, or its representative, of your vehicle or any equipment that has been added.

Only qualified personnel should service the device or install the device in a vehicle. Faulty installation or service may be dangerous and may invalidate any warranty that may apply to the device. Check regularly that all wireless device equipment in your vehicle is mounted and operating properly. Do not store or carry flammable liquids, gases, or

explosive materials in the same compartment as the device, its parts, or enhancements. For vehicles equipped with an air bag, remember that air bags inflate with great force. Do not place objects, including installed or portable wireless equipment in the area over the air bag or in the air bag deployment area. If in-vehicle wireless equipment is improperly installed and the air bag inflates, serious injury could result.

Using your device while flying in aircraft is prohibited. Switch off your device before boarding an aircraft. The use of wireless teledevices in an aircraft may be dangerous to the operation of the aircraft, disrupt the wireless telephone network, and may be illegal.

Potentially explosive environments

Switch off your device when in any area with a potentially explosive atmosphere, and obey all signs and instructions. Potentially explosive atmospheres include areas where you would normally be advised to turn off your vehicle engine. Sparks in such areas could cause an explosion or fire resulting in bodily injury or even death. Switch off the device at refuelling points such as near gas pumps at service stations. Observe restrictions on the use of radio equipment in fuel depots, storage, and distribution areas; chemical plants; or where blasting operations are in progress. Areas with a potentially explosive atmosphere are often, but not always, clearly marked. They include below deck on boats, chemical transfer or storage facilities and areas where the air contains chemicals or particles such as grain, dust, or metal powders. You should check with the manufacturers of vehicles using liquefied petroleum gas (such as propane or butane) to determine if this device can be safely used in their vicinity.

Emergency calls



Important: This device operates using radio signals, wireless networks, landline networks, and user-programmed functions. If your device supports voice calls over the internet (internet calls), activate both the internet calls and the cellular phone. The device will attempt to make emergency calls over both the cellular networks and through your internet call provider if both are activated. Connections in all conditions cannot be guaranteed. You should never rely solely on any wireless device for essential communications like medical emergencies.

To make an emergency call:

1. If the device is not on, switch it on. Check for adequate signal strength. Depending on your device, you may also need to complete the following:
 - Insert a SIM card if your device uses one.
 - Remove certain call restrictions you have activated in your device.
 - Change your profile from offline or flight profile mode to an active profile.
2. Press the end key as many times as needed to clear the display and ready the device for calls.

Additional safety information

3. Enter the official emergency number for your present location. Emergency numbers vary by location.
4. Press the call key.

When making an emergency call, give all the necessary information as accurately as possible. Your wireless device may be the only means of communication at the scene of an accident. Do not end the call until given permission to do so.

Certification information (SAR)

This mobile device meets guidelines for exposure to radio waves.

Your mobile device is a radio transmitter and receiver. It is designed not to exceed the limits for exposure to radio waves recommended by international guidelines. These guidelines were developed by the independent scientific organisation ICNIRP and include safety margins designed to assure the protection of all persons, regardless of age and health.

The exposure guidelines for mobile devices employ a unit of measurement known as the Specific Absorption Rate or SAR. The SAR limit stated in the ICNIRP guidelines is 2.0 watts/kilogram (W/kg) averaged over 10 grams of tissue. Tests for SAR are conducted using standard operating positions with the device transmitting at its highest certified power level in all tested frequency bands. The actual SAR level of an operating device can be below the maximum value because the device is designed to use only the power required to reach the network. That amount changes depending on a number of factors such as how close you are to a network base station. The highest SAR value under the ICNIRP guidelines for use of the device at the ear is 0.52 W/kg .

Use of device accessories may result in different SAR values. SAR values may vary depending on national reporting and testing requirements and the network band. Additional SAR information may be provided under product information at www.nokia.com.

Index

A

access codes 8
accessories 34
anykey answer 33
applications 46

B

barring password 8
battery 13
battery charge status 17
browser 47
business cards 28

C

cache memory 48
calculator 45
call divert 33
call log 28
call waiting 33
caller id 33
camera 38, 39
configuration 34
configuration setting service 9
cookies 48
cover 13

D

data cable 30
dialling shortcuts 20, 28
display 17, 32
downloads 9

E

e-mail 24
equaliser 42

F

factory settings 36
flash messages 25
flight mode 18
flight query 33
font size 32

G

games 46
general packet radio service 30
GPRS 30
GPS 44

H

handsfree 20
headset 14
help text 33
helpful hints 10
home screen 17, 32

I

IM 25
in-call timer 33
indicators 18
info messages 25
instant messaging 25
internet 47

K

keyguard 33
keypad lock 19
keys 15

L

language 33
lights 31
location information 28
loudspeaker 20

M

Maps 43
media player 39
memory card 12, 37
message centre number 22
message sending 23
microSD card 12
My Nokia 9

N

navigation 16
Nokia Care 10
notes 45
number mode 21

O

offline mode 19
online sharing 47
operator menu 36

P

packet data 30
parts 15
PC Suite 31
phone software updates 33
PictBridge 30
picture 38
PIN 8
position log 28
predictive text input 21
print images 37
profiles 31
PUK 8

R

radio 40
recorder 41
redial 33

S

scrolling 16
security code 8
security module 8
service commands 25
settings 31
sharing 47
shortcuts 17, 32
signal strength 17
SIM
 services 49
SIM card 11, 19
SIM messages 25
software update 10, 35

speed dialling 20, 28, 33
start up tone 33
status indicators 17
stereo widening 42
stopwatch 46
strap 15

T

take a picture 38
text modes 21
themes 31
tones 31
traditional text input 21

U

UPIN 8
USB data cable 30

V

video clips 38
Visual Radio 41
voice clarity 33
voice commands 34
voice dialling 20
voice recognition 34
voice recorder 41

W

wallpaper 32
web 47
write text 21