

# Nokia 5310 XpressMusic User Guide

---

Issue 1

DECLARATION OF CONFORMITY

**CE 0434**

Hereby, NOKIA CORPORATION declares that this RM-303 product is in compliance with the essential requirements and other relevant provisions of Directive 1999/5/EC. A copy of the Declaration of Conformity can be found at [http://www.nokia.com/phones/declaration\\_of\\_conformity/](http://www.nokia.com/phones/declaration_of_conformity/).

© 2007 Nokia. All rights reserved.

Nokia, Nokia Connecting People, Visual Radio, and Navi are trademarks or registered trademarks of Nokia Corporation. Nokia tune is a sound mark of Nokia Corporation. Other product and company names mentioned herein may be trademarks or tradenames of their respective owners.

Reproduction, transfer, distribution, or storage of part or all of the contents in this document in any form without the prior written permission of Nokia is prohibited.

US Patent No 5818437 and other pending patents. T9 text input software Copyright © 1997-2007. Tegic Communications, Inc. All rights reserved.



Includes RSA BSAFE cryptographic or security protocol software from RSA Security.



**Java**  
POWERED

Java and all Java-based marks are trademarks or registered trademarks of Sun Microsystems, Inc.

This product is licensed under the MPEG-4 Visual Patent Portfolio License (i) for personal and noncommercial use in connection with information which has been encoded in compliance with the MPEG-4 Visual Standard by a consumer engaged in a personal and noncommercial activity and (ii) for use in connection with MPEG-4 video provided by a licensed video provider. No license is granted or shall be implied for any other use. Additional information, including that related to promotional, internal, and commercial uses, may be obtained from MPEG LA, LLC. See <http://www.mpegla.com>.

Nokia operates a policy of ongoing development. Nokia reserves the right to make changes and improvements to any of the products described in this document without prior notice.

TO THE MAXIMUM EXTENT PERMITTED BY APPLICABLE LAW, UNDER NO CIRCUMSTANCES SHALL NOKIA OR ANY OF ITS LICENSORS BE RESPONSIBLE FOR ANY LOSS OF DATA OR INCOME OR ANY SPECIAL, INCIDENTAL, CONSEQUENTIAL OR INDIRECT DAMAGES HOWSOEVER CAUSED.

THE CONTENTS OF THIS DOCUMENT ARE PROVIDED "AS IS". EXCEPT AS REQUIRED BY APPLICABLE LAW, NO WARRANTIES OF ANY KIND, EITHER EXPRESS OR IMPLIED, INCLUDING, BUT NOT LIMITED TO, THE IMPLIED WARRANTIES OF MERCHANTABILITY AND FITNESS FOR A PARTICULAR PURPOSE, ARE MADE IN RELATION TO THE ACCURACY, RELIABILITY OR CONTENTS OF THIS DOCUMENT. NOKIA RESERVES THE RIGHT TO REVISE THIS DOCUMENT OR WITHDRAW IT AT ANY TIME WITHOUT PRIOR NOTICE.

For the most current product information, please refer to [www.nokia.com.hk](http://www.nokia.com.hk).

The availability of particular products and applications and services for these products may vary by region. Please check with your Nokia dealer for details, and availability of language options.

#### Export controls

This device may contain commodities, technology or software subject to export laws and regulations from the US and other countries. Diversion contrary to law is prohibited.

The third-party applications provided with your device may have been created and may be owned by persons or entities not affiliated with or related to Nokia. Nokia does not own the copyrights or intellectual property rights to the third-party applications. As such, Nokia does not take any responsibility for end-user support, functionality of the applications, or the information in the applications or these materials. Nokia does not provide any warranty for the third-party applications.

BY USING THE APPLICATIONS YOU ACKNOWLEDGE THAT THE APPLICATIONS ARE PROVIDED AS IS WITHOUT WARRANTY OF ANY KIND, EXPRESS OR IMPLIED, TO THE MAXIMUM EXTENT PERMITTED BY APPLICABLE LAW. YOU FURTHER ACKNOWLEDGE THAT NEITHER NOKIA NOR ITS AFFILIATES MAKE ANY REPRESENTATIONS OR WARRANTIES, EXPRESS OR IMPLIED, INCLUDING BUT NOT LIMITED TO WARRANTIES OF TITLE, MERCHANTABILITY OR FITNESS FOR A PARTICULAR PURPOSE, OR THAT THE APPLICATIONS WILL NOT INFRINGE ANY THIRD-PARTY PATENTS, COPYRIGHTS, TRADEMARKS, OR OTHER RIGHTS.

Issue 1

# Contents

|                                    |           |  |           |
|------------------------------------|-----------|--|-----------|
| <b>For your safety .....</b>       | <b>6</b>  | <b>Calls.....</b>  | <b>16</b> |
| <b>General information.....</b>    | <b>7</b>  | Make a call.....   | 16        |
| About your phone.....              | 7         | Answer or end a call.....                                | 16        |
| Network services.....              | 7         | Dialing shortcuts.....                                   | 16        |
| Enhancements.....                  | 7         | Voice dialing.....                                       | 16        |
| Access codes.....                  | 8         | Options during a call.....                               | 17        |
| Configuration setting service..... | 8         | <b>Write text.....</b>                                   | <b>18</b> |
| Download content.....              | 8         | Text modes.....  | 18        |
| Nokia support.....                 | 8         | Traditional text input.....                              | 18        |
| Digital rights management.....     | 9         | Predictive text input.....                               | 18        |
| <b>Get started.....</b>            | <b>10</b> | <b>Navigate the menus.....</b>                           | <b>19</b> |
| Install SIM card and battery.....  | 10        | <b>Messaging.....</b>                                    | <b>20</b> |
| Insert a microSD card.....         | 10        | Text and multimedia messages.....                        | 20        |
| Remove the microSD card.....       | 11        | Text messages.....                                       | 20        |
| Charge the battery.....            | 11        | Multimedia messages.....                                 | 20        |
| Antenna.....                       | 12        | Create a text or multimedia message.....                 | 20        |
| Headset.....                       | 12        | Read a message and reply.....                            | 21        |
| Strap.....                         | 12        | Send messages.....                                       | 21        |
| Keys and parts.....                | 12        | E-mail.....  | 21        |
| Switch the phone on and off.....   | 13        | E-mail setup wizard.....                                 | 21        |
| Standby mode.....                  | 13        | Write and send an e-mail.....                            | 21        |
| Display.....                       | 13        | Read an e-mail and reply.....                            | 22        |
| Power saving.....                  | 14        | New e-mail notifications.....                            | 22        |
| Active standby.....                | 14        | Flash messages.....                                      | 22        |
| Shortcuts in the standby mode..... | 14        | Nokia Xpress audio messages.....                         | 22        |
| Indicators.....                    | 14        | Instant messaging.....                                   | 23        |
| Flight mode.....                   | 15        | Info messages, SIM messages and service<br>commands..... | 23        |
| Keypad lock (keyguard).....        | 15        | Voice messages.....                                      | 23        |
| Functions without a SIM card.....  | 15        |  |           |

|                                    |           |
|------------------------------------|-----------|
| Message settings.....              | 23        |
| <b>Contacts.....</b>               | <b>24</b> |
| Manage contacts.....               | 24        |
| Business cards.....                | 25        |
| Assign dialing shortcuts.....      | 25        |
| <b>Call log .....</b>              | <b>26</b> |
| <b>Settings.....</b>               | <b>27</b> |
| Profiles.....                      | 27        |
| Themes.....                        | 27        |
| Tones.....                         | 27        |
| Display.....                       | 27        |
| Date and time.....                 | 28        |
| My shortcuts.....                  | 28        |
| Left and right selection key.....  | 28        |
| Other shortcuts.....               | 28        |
| Synchronization and backup.....    | 28        |
| Connectivity.....                  | 28        |
| Bluetooth wireless technology..... | 28        |
| Packet data.....                   | 29        |
| USB data cable.....                | 30        |
| Nokia PC Suite.....                | 30        |
| Call.....                          | 30        |
| Phone.....                         | 30        |
| Voice commands.....                | 31        |
| Enhancements.....                  | 31        |
| Configuration.....                 | 31        |
| Security.....                      | 32        |
| Restore factory settings.....      | 33        |
| <b>Operator menu.....</b>          | <b>34</b> |

|                                   |           |
|-----------------------------------|-----------|
| <b>Gallery.....</b>               | <b>35</b> |
| Folders and files.....            | 35        |
| Print images.....                 | 35        |
| Memory card.....                  | 35        |
| <b>Media.....</b>                 | <b>37</b> |
| Camera and video.....             | 37        |
| Take a picture.....               | 37        |
| Record a video clip.....          | 37        |
| Camera and video options.....     | 37        |
| Music player.....                 | 37        |
| Music menu.....                   | 37        |
| Play music tracks.....            | 38        |
| Change the music player look..... | 38        |
| Radio.....                        | 39        |
| Tune in to radio stations.....    | 39        |
| Radio features.....               | 39        |
| Voice recorder.....               | 40        |
| Equalizer.....                    | 40        |
| <b>Push to talk.....</b>          | <b>41</b> |
| <b>Applications.....</b>          | <b>42</b> |
| Launch an application.....        | 42        |
| Download an application.....      | 42        |
| <b>Organizer.....</b>             | <b>43</b> |
| Alarm clock.....                  | 43        |
| Calendar.....                     | 43        |
| To-do list.....                   | 43        |
| Notes.....                        | 44        |
| Calculator.....                   | 44        |
| Timers.....                       | 44        |
| Stopwatch.....                    | 44        |

|  |           |
|--|-----------|
| <b>Web .....</b>                             | <b>45</b> |
| Connect to a service.....                    | 45        |
| Appearance settings.....                     | 45        |
| Security settings.....                       | 46        |
| Cache memory.....                            | 46        |
| Scripts over secure connection.....          | 46        |
| Service inbox.....                           | 46        |
| Browser security.....                        | 46        |
| Certificates.....                            | 47        |
| Digital signature.....                       | 47        |
| <b>SIM services.....</b>                     | <b>48</b> |
| <b>Genuine enhancements.....</b>             | <b>49</b> |
| Enhancements.....                            | 49        |
| Battery.....                                 | 49        |
| <b>Battery information.....</b>              | <b>50</b> |
| Charging and discharging.....                | 50        |
| Nokia battery authentication guidelines..... | 50        |
| Authenticate hologram.....                   | 51        |
| What if your battery is not authentic?.....  | 51        |
| <b>Care and maintenance.....</b>             | <b>52</b> |
| <b>Additional safety information.....</b>    | <b>53</b> |
| Small children.....                          | 53        |
| Operating environment.....                   | 53        |
| Medical devices.....                         | 53        |
| Implanted medical devices.....               | 53        |
| Hearing aids.....                            | 54        |
| Vehicles.....                                | 54        |
| Potentially explosive environments.....      | 54        |
| Emergency calls.....                         | 54        |

|                                      |           |
|--------------------------------------|-----------|
| CERTIFICATION INFORMATION (SAR)..... | 55        |
| <b>Limited Warranty.....</b>         | <b>56</b> |
| <b>Index.....</b>                    | <b>59</b> |

# For your safety

Read these simple guidelines. Not following them may be dangerous or illegal. Read the complete user guide for further information.



## **SWITCH ON SAFELY**

Do not switch the device on when wireless phone use is prohibited or when it may cause interference or danger.



## **ROAD SAFETY COMES FIRST**

Obey all local laws. Always keep your hands free to operate the vehicle while driving. Your first consideration while driving should be road safety.



## **INTERFERENCE**

All wireless devices may be susceptible to interference, which could affect performance.



## **SWITCH OFF IN HOSPITALS**

Follow any restrictions. Switch the device off near medical equipment.



## **SWITCH OFF IN AIRCRAFT**

Follow any restrictions. Wireless devices can cause interference in aircraft.



## **SWITCH OFF WHEN REFUELING**

Do not use the device at a refueling point. Do not use near fuel or chemicals.



## **SWITCH OFF NEAR BLASTING**

Follow any restrictions. Do not use the device where blasting is in progress.



## **QUALIFIED SERVICE**

Only qualified personnel may install or repair this product.



## **ENHANCEMENTS AND BATTERIES**

Use only approved enhancements and batteries. Do not connect incompatible products.



## **WATER-RESISTANCE**

Your device is not water-resistant. Keep it dry.



## **EMERGENCY CALLS**

Ensure the phone function of the device is switched on and in service. Press the end key as many times as needed to clear the display and return to the standby mode. Enter the emergency number, then press the call key. Give your location. Do not end the call until given permission to do so.

# General information

## About your phone

The wireless device described in this guide is approved for use on the EGSM 900 and GSM 1800 and 1900 networks. Contact your service provider for more information about networks.

When using the features in this device, obey all laws and respect local customs, privacy and legitimate rights of others, including copyrights.

Copyright protections may prevent some images, music (including ringing tones), and other content from being copied, modified, transferred, or forwarded.

Remember to make back-up copies or keep a written record of all important information stored in your device.

When connecting to any other device, read its user guide for detailed safety instructions. Do not connect incompatible products.



**Warning:** To use any features in this device, other than the alarm clock, the device must be switched on. Do not switch the device on when wireless device use may cause interference or danger.

## Network services

To use the phone you must have service from a wireless service provider. Many of the features require special network features. These features are not available on

all networks; other networks may require that you make specific arrangements with your service provider before you can use the network services. Your service provider can give you instructions and explain what charges will apply. Some networks may have limitations that affect how you can use network services. For instance, some networks may not support all language-dependent characters and services.

Your service provider may have requested that certain features be disabled or not activated in your device. If so, these features will not appear on your device menu. Your device may also have a special configuration such as changes in menu names, menu order, and icons. Contact your service provider for more information.

## Enhancements

Practical rules about accessories and enhancements

- Keep all accessories and enhancements out of the reach of small children.
- When you disconnect the power cord of any accessory or enhancement, grasp and pull the plug, not the cord.
- Check regularly that enhancements installed in a vehicle are mounted and are operating properly.
- Installation of any complex car enhancements must be made by qualified personnel only.



## Access codes

To set how your phone uses the access codes and security settings, select **Menu > Settings > Security**.

- The security code helps to protect your phone against unauthorized use. The preset code is **12345**. You can change the code, and set the phone to request the code.
- The PIN (UPIN) code, supplied with the SIM (USIM) card, helps to protect the card against unauthorized use.
- The PIN2 (UPIN2) code, supplied with some SIM (USIM) cards, is required to access certain services.
- PUK (UPUK) and PUK2 (UPUK2) codes may be supplied with the SIM (USIM) card. If you enter the PIN code incorrectly three times in succession, you are asked for the PUK code. If the codes are not supplied, contact your service provider.
- The barring password is required when using the **Call barring service** to restrict incoming calls to and outgoing calls from your phone (network service).
- To view or change the security module settings, select **Menu > Settings > Security > Security module sett..**

## Configuration setting service

To use some of the network services, such as mobile internet services, MMS, Nokia Xpress audio messaging, or remote internet server synchronization, your phone needs the correct configuration settings. For more information on availability, contact your service

provider or the nearest authorized Nokia dealer, or visit the support area on the Nokia website. [See "Nokia support," p. 8.](#)

When you have received the settings as a configuration message and the settings are not automatically saved and activated, **Configuration settings received** is displayed.

To save the settings, select **Show > Save**. If required, enter the PIN code supplied by the service provider.

## Download content

You may be able to download new content (for example, themes) to your phone (network service).



**Important:** Use only services that you trust and that offer adequate security and protection against harmful software.

For the availability of different services and pricing, contact your service provider.

## Nokia support

Check [www.nokia.com.hk/support](http://www.nokia.com.hk/support) or your local Nokia website for the latest version of this guide, additional information, downloads, and services related to your Nokia product.

### Configuration settings service

Download free configuration settings such as MMS, GPRS, e-mail, and other services for your phone model at [www.nokia.com.hk/settings](http://www.nokia.com.hk/settings).

## **Nokia PC Suite**

You may find PC Suite and related information on the Nokia website at [www.nokia.com.hk/pcsuite](http://www.nokia.com.hk/pcsuite).

## **Customer service**

If you need to contact customer service, check the list of local Nokia Care contact centers at [www.nokia.com.hk/contactus](http://www.nokia.com.hk/contactus).



## **Maintenance**

For maintenance services, check your nearest Nokia service center at [www.nokia.com.hk/repair](http://www.nokia.com.hk/repair).

# **Digital rights management**

Content owners may use different types of digital rights management technologies (DRM) to protect their intellectual property including copyrights. This device uses various types of DRM software to access DRM protected content. With this device you may be able to access content protected with WMDRM 10, OMA DRM 1.0, OMA DRM 1.0 forward lock, and OMA DRM 2.0. If certain DRM software fails to protect the content, content owners may ask that such DRM software's ability to access new DRM protected content be revoked. Revocation may also prevent renewal of such DRM protected content already in your device. Revocation of such DRM software does not affect the use of content protected with other types of DRM or the use of non-DRM-protected content.

DRM protected content comes with an associated activation key that defines your rights to use the content.

To back up OMA DRM protected content, use the backup feature of Nokia PC Suite.

If your device has WMDRM protected content, both the activation keys and the content will be lost if the device memory is formatted. You may also lose the activation keys and the content in case the files on your device get corrupted. Losing the activation keys or the content may limit your ability to use the same content on your device again. For more information, contact your service provider.

# Get started

## Install SIM card and battery

Always switch the device off and disconnect the charger before removing the battery.

For availability and information on using SIM card services, contact your SIM card vendor. This may be the service provider or other vendor.

This phone is intended for use with a BL-4CT battery. Always use original Nokia batteries.

The SIM card and its contacts can be easily damaged by scratches or bending, so be careful when handling, inserting, or removing the card.

 **Important:** To release the SIM card lock, always remove the battery before you insert or remove the SIM card.

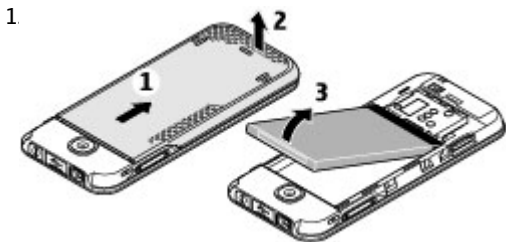

2. Insert or remove the SIM card (4).
3. Insert the battery (5) and replace the



back cover (6, 7).

## Insert a microSD card

Use only compatible microSD cards approved by Nokia for use with this device. Nokia uses approved industry standards for memory cards, but some brands may not be fully compatible with this device. Incompatible cards may damage the card and the device and corrupt data stored on the card.

1. Remove the back cover of the phone.

2. Insert the card into the microSD card slot with the contact surface facing down, and press it until it locks into place.



## Remove the microSD card

 **Important:** Do not remove the memory card in the middle of an operation when the card is being accessed. Removing the card in the middle of an operation may damage the memory card as well as the device, and data stored on the card may be corrupted.

You can remove or replace the microSD card during phone operation without switching the device off.

1. Make sure that no application is currently accessing the microSD memory card.
2. Remove the back cover of the device.
3. Press the microSD card slightly in to release the lock and remove it.

## Charge the battery

Check the model number of any charger before use with this device. This device is intended for use when supplied with power from the AC-3 and AC-4 charger.

The exact charger model number may vary depending on the type of plug. For example, the model numbers for the AC-3 charger can be AC-3C, AC-3U, AC-3X, etc.

 **Warning:** Use only batteries, chargers, and enhancements approved by Nokia for use with this particular model. The use of any other types may invalidate any approval or warranty, and may be dangerous.

For availability of approved enhancements, please check with your dealer. When you disconnect the power cord of any enhancement, grasp and pull the plug, not the cord.

1. Connect the charger to a wall socket.
2. Connect the lead from the charger to the charger connector of your phone.



If the battery is completely discharged, it may take a few minutes before the charging indicator appears on the display or before any calls can be made.

The charging time depends on the charger used. Charging a BL-4CT battery with the AC-3 charger takes approximately 2 hours 30 minutes while the phone is in the standby mode.

## Antenna

 **Note:** As with any radio transmitting device, avoid touching an antenna unnecessarily when the antenna is in use. For example, avoid touching the cellular antenna during a phone call. Contact with a transmitting or receiving antenna affects the quality of the radio communication, may cause the device to operate at a higher power level than otherwise needed, and may reduce the battery life.



The picture shows the antenna area marked in grey.

## Headset

 **Warning:** Listen to music at a moderate level. Continuous exposure to high volume may damage your hearing.

When connecting any external device or any headset, other than those approved by Nokia for use with this device, to the Nokia AV Connector, pay special attention to volume levels.

 **Warning:** When you use the headset, your ability to hear outside sounds may be affected. Do not use the headset where it can endanger your safety. Do not connect products that create an output signal as this may cause damage to the device. Do not connect any voltage source to the Nokia AV Connector.

## Strap

Thread the strap as shown in the picture and tighten it.



## Keys and parts

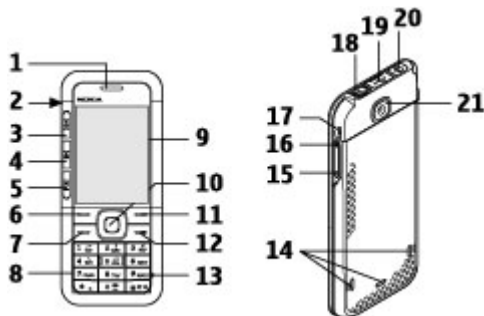

- 1 — Earpiece
- 2 — Charger connector
- 3 — Music player: skip/rewind key
- 4 — Music player: play/pause key
- 5 — Music player: skip/forward key
- 6 — Left selection key
- 7 — Call key

- 8 — Keypad
- 9 — Display
- 10 — Navi™ key: hereafter referred to as the scroll key
- 11 — Right selection key
- 12 — End key
- 13 — Microphone
- 14 — Loudspeaker
- 15 — Volume down key
- 16 — Volume up key
- 17 — Strap eyelet
- 18 — Nokia AV Connector (3.5 mm)
- 19 — Micro USB cable connector
- 20 — Power key
- 21 — Camera lens

## Switch the phone on and off

To switch the phone on or off, press and hold the power key.

If the phone prompts for a PIN or a UPIN code, enter the code (displayed as \*\*\*).

The phone may prompt you to set the time and date. Enter the local time, select the time zone of your location in terms of the time difference with respect to Greenwich Mean Time (GMT), and enter the date. [See "Date and time," p. 28.](#)

When you switch on your phone for the first time, you may be prompted to get the configuration settings from your service provider (network service). For more



information, refer to **Connect to support**. See "[Configuration](#)", p. 31, and "[Configuration setting service](#)", p. 8

## Standby mode

When the phone is ready for use, and you have not entered any characters, the phone is in the standby mode.

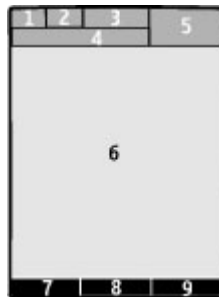
### Display



- 1 — Signal strength of the cellular network 
- 2 — Battery charge status 
- 3 — Indicators
- 4 — Name of the network or the operator logo
- 5 — Clock
- 6 — Display
- 7 — Function of the left selection key

8 — Function of the Navi key

9 — Function of the right selection key

You may change the function of the left and right selection key. [See "Left and right selection key," p. 28.](#)

## Power saving

Your phone has a **Power saver** and a **Sleep mode** feature in order to save battery power in the standby mode when no keys are pressed. These features may be activated. [See "Display," p. 27.](#)

## Active standby

The active standby mode displays a list of selected phone features and information that you can directly access.

To switch active standby on or off, select **Menu > Settings > Display > Active standby > Active standby mode.**

In the standby mode, scroll up or down to navigate in the list, and choose **Select** or **View**. The arrows indicate that further information is available. To stop navigation, select **Exit**.

To organize and change the active standby mode, select **Options**.

## Shortcuts in the standby mode

















To access the list of dialed numbers, press the call key once. Scroll to the number or name, and press the call key to call the number.

To open the web browser, press and hold **0**.

To call your voice mailbox, press and hold **1**.

Use keys as a shortcut. [See "Dialing shortcuts," p. 16.](#)

## Indicators

-  unread messages
-  unsent, canceled, or failed messages
-  missed call
-  The keypad is locked.
-  The phone does not ring for an incoming call or text message.
-  The alarm clock is activated.
-  **G/E** The phone is registered to the GPRS or EGPRS network.
-   A GPRS or EGPRS connection is established.
-   The GPRS or EGPRS connection is suspended (on hold).
-  A Bluetooth connection is active.
-  If you have two phone lines, the second phone line is selected.
-  All incoming calls are diverted to another number.
-  Calls are limited to a closed user group.
-  The timed profile is selected.

## Flight mode

Use the flight mode in radio sensitive environments—on board aircraft or in hospitals—to deactivate all radio frequency functions. You still have access to offline games, calendar, and phone numbers. When the flight mode is active,  is shown.

To activate or set up the flight mode, select **Menu** > **Settings** > **Profiles** > **Flight** > **Activate** or **Personalise**.

To deactivate the flight mode, select any other profile.

### Emergency call in flight mode

Enter the emergency number, press the call key, and select **Yes** when **Exit flight profile?** is displayed.



**Warning:** With the flight profile you cannot make or receive any calls, including emergency calls, or use other features that require network coverage. To make calls, you must first activate the phone function by changing profiles. If the device has been locked, enter the lock code. If you need to make an emergency call while the device is locked and in the flight profile, you may be also able to enter an official emergency number programmed in your device in the lock code field and select 'Call'. The device will confirm that you are about to exit flight profile to start an emergency call.

## Keypad lock (keyguard)

To prevent accidental keypresses, select **Menu**, and press \* within 3.5 seconds to lock the keypad.

To unlock the keypad, select **Unlock**, and press \* within 1.5 seconds. If **Security keyguard** is set to on, enter the security code if requested.

To answer a call when the keypad is locked, press the call key. When you end or reject the call, the keypad automatically locks.

Further features are **Automatic keyguard** and **Security keyguard**. See "[Phone](#)," p. 30.

When the device or keypad is locked, calls may be possible to the official emergency number programmed into your device.

## Functions without a SIM card

Some functions of your phone may be used without installing a SIM card, such as music player, radio, games, and data transfer with a compatible PC or another compatible device. Some functions appear dimmed in the menus and cannot be used.



# Calls

## Make a call

You can start a call in several ways:

- Enter the phone number, including the area code, and press the call key.  
For international calls, press \* twice for the international prefix (the + character replaces the international access code), enter the country code, the area code without the leading 0, if necessary, and the phone number.
- To access the list of dialed numbers, press the call key once in the standby mode. Select a number or name, and press the call key.
- Search for a name or phone number that you saved in **Contacts**. See "[Manage contacts](#)," p. 24.

To adjust the volume in a call, press the volume key up or down.

## Answer or end a call

To answer an incoming call, press the call key. To end the call, press the end key.

To reject an incoming call, press the end key. To mute the ringing tone, select **Silence**.

## Dialing shortcuts

First assign a phone number to one of the number keys, 2 to 9. See "[Assign dialing shortcuts](#)," p. 25.

Use a dialing shortcut to make a call in one of the following ways:

- Press a number key, then the call key.
- If **Menu > Settings > Call > Speed dialling > On** is selected, press and hold a number key.

## Voice dialing

Make a phone call by saying the name that is saved in the contact list of the phone.

As voice commands are language-dependent, you must select **Menu > Settings > Phone > Language settings > Recognition lang.** and your language before using voice dialing.



**Note:** Using voice tags may be difficult in a noisy environment or during an emergency, so you should not rely solely upon voice dialing in all circumstances.

1. In the standby mode, press and hold the right selection key or the volume down key. A short tone sounds, and **Speak now** is displayed.
2. Speak the name of the contact you want to dial. If the voice recognition is successful, a list with matches is shown. The phone plays the voice command of the first match on the list. If it is not the correct command, scroll to another entry.

## Options during a call

Many of the options that you can use during a call are network services. For availability, contact your service provider.

During a call, select **Options** and from the following options:

Call options are **Mute** or **Unmute**, **Contacts**, **Menu**, **Lock keypad**, **Record**, **Voice clarity**, **Loudspeaker** or **Handset**.

Network options are **Answer** or **Reject**, **Hold** or **Unhold**, **New call**, **Add to conference**, **End call**, **End all calls**, and the following:

- **Send DTMF** — to send tone strings
- **Swap** — to switch between the active call and the call on hold
- **Transfer** — to connect a call on hold to an active call and disconnect yourself
- **Conference** — to make a conference call
- **Private call** — to have a private discussion in a conference call









**Warning:** Do not hold the device near your ear when the loudspeaker is in use, because the volume may be extremely loud.

# Write text

## Text modes

To enter text (for example, when writing messages) you can use traditional or predictive text input.

When you write text, press and hold **Options** to toggle between traditional text input, indicated by , and predictive text input, indicated by . Not all languages are supported by predictive text input.

The character cases are indicated by , , and . To change the character case, press **#**. To change from the letter to number mode, indicated by , press and hold **#**, and select **Number mode**. To change from the number to the letter mode, press and hold **#**.

To set the writing language, select **Options** > **Writing language**.

## Traditional text input

Press a number key, **2** to **9**, repeatedly until the desired character appears. The available characters depend on the selected writing language.

If the next letter you want is located on the same key as the present one, wait until the cursor appears and enter the letter.

To access the most common punctuation marks and special characters, repeatedly press the number key **1** or press **\*** to select a special character.

## Predictive text input

Predictive text input is based on a built-in dictionary to which you can also add new words.

1. Start writing a word, using the keys **2** to **9**. Press each key only once for one letter.
2. To confirm a word by adding a space, press **0**.
  - If the word is not correct, press **\*** repeatedly, and select the word from the list.
  - If the ? character is displayed after the word, the word you intended to write is not in the dictionary. To add the word to the dictionary, select **Spell**. Enter the word using traditional text input, and select **Save**.
  - To write compound words, enter the first part of the word, and press the scroll key right to confirm it. Write the last part of the word, and confirm the word.
3. Start writing the next word.

## Navigate the menus

The phone offers you an extensive range of functions that are grouped into menus.

1. To access the menu, select **Menu**.
2. Scroll through the menu, and select an option (for example, **Settings**).
3. If the selected menu contains further submenus, select one (for example, **Call**).
4. If the selected menu contains further submenus, repeat step 3.
5. Select the setting of your choice.
6. To return to the previous menu level, select **Back**.  
To exit the menu, select **Exit**.

To change the menu view, select **Options** > **Main menu view** > **List**, **Grid**, **Grid with labels**, or **Tab**.

To rearrange the menu, scroll to the menu to be moved, and select **Options** > **Organise** > **Move**. Scroll to where you want to move the menu, and select **OK**. To save the change, select **Done** > **Yes**.

# Messaging

You can read, write, send and save text and multimedia messages, e-mail, audio and flash messages. The messaging services can only be used if they are supported by your network or service provider.

## Text and multimedia messages

You can create a message and optionally attach for example a picture. Your phone automatically changes a text message to a multimedia message when a file is attached.

## Text messages

Your device supports the sending of text messages beyond the limit for a single message. Longer messages are sent as two or more messages. Your service provider may charge accordingly. Characters with accents or other marks, and characters from some language options, take up more space, and limit the number of characters that can be sent in a single message.

An indicator at the top of the display shows the total number of characters left and the number of messages needed for sending.

Before you can send any text or SMS e-mail messages, you must save your message center number. Select **Menu > Messaging > Message settings > Text messages > Message centres > Add centre**, enter a name, and the number from the service provider.

## Multimedia messages

A multimedia message can contain text, pictures, sound clips, and video clips.



**Important:** Exercise caution when opening messages. Messages may contain malicious software or otherwise be harmful to your device or PC.

To check availability and to subscribe to the multimedia messaging service (MMS), contact your service provider. You also may download the configuration settings. [See "Nokia support," p. 8.](#)

## Create a text or multimedia message

1. Select **Menu > Messaging > Create message > Message**.
2. To add recipients, scroll to the **To:** field, and enter the recipient's number or e-mail address, or select **Add** to select recipients from the available options. Select **Options** to add recipients and subjects and to set sending options.
3. Scroll to the **Text:** field, and enter the message text.
4. To attach content to the message, scroll to the attachment bar at the bottom of the display and select the desired type of content.
5. To send the message, press **Send**.

The message type is indicated at the top of the display and changes automatically depending on the content of the message.

Service providers may charge differently depending on the message type. Check with your service provider for details.

## Read a message and reply



**Important:** Exercise caution when opening messages. E-mail messages or multimedia message objects may contain malicious software or otherwise be harmful to your device or PC.

Your phone issues a notification when a message is received. Press **Show** to display the message. If more than one message was received select a message from the inbox and press **Open**. Use the scroll key to view all parts of the message.

Select **Reply** to create an answer message.

## Send messages

### Message sending

To send the message, select **Send**. The phone saves the message in the **Outbox** folder, and the sending starts.



**Note:** The message sent icon or text on your device screen does not indicate that the message is received at the intended destination.

If message sending is interrupted, the phone tries to resend the message a few times. If these attempts fail, the message remains in the **Outbox** folder. To cancel the sending of the messages in the **Outbox** folder, select **Options** > **Cancel sending**.

To save the sent messages in the **Sent items** folder, select **Menu** > **Messaging** > **Message settings** > **General settings** > **Save sent messages**.

### Organize your messages

The phone saves received messages in the **Inbox** folder. Organize your messages in the saved items folder.

To add, rename, or delete a folder, select **Menu** > **Messaging** > **Saved items** > **Options**.

## E-mail

Access your POP3 or IMAP4 e-mail account with your phone to read, write and send e-mail. This e-mail application is different from the SMS e-mail function.

Before you can use e-mail, you must have an e-mail account and the correct settings. To check the availability and the settings of your e-mail account, contact your e-mail service provider. You may receive the e-mail configuration settings as a configuration message. See "[Configuration setting service](#)," p. 8.

### E-mail setup wizard

The e-mail setup wizard starts automatically if no e-mail settings are defined in the phone. To start the setup wizard for an additional e-mail account, select **Menu** > **Messaging** and the existing e-mail account. Select **Options** > **Add mailbox** to start the e-mail setup wizard. Follow the instructions on the display.

### Write and send an e-mail

You may write your e-mail before connecting to the e-mail service.

1. Select **Menu > Messaging > Create message > E-mail message**.
2. If more than one e-mail account is defined, select the account from which you want to send the e-mail.
3. Enter the recipient's e-mail address, the subject, and the e-mail message. To attach a file, select **Insert** and from the options.
4. To send the e-mail, select **Send**.

## Read an e-mail and reply

 **Important:** Exercise caution when opening messages. E-mail messages may contain malicious software or otherwise be harmful to your device or PC.

1. To download e-mail message headers, select **Menu > Messaging** and your e-mail account.
2. To download an e-mail and attachments, select an e-mail and press **Open** or **Retrieve**.
3. To reply or forward the e-mail, select **Options**.
4. To disconnect from your e-mail account, select **Options > Disconnect**. The connection to the e-mail account automatically ends after some time without activity.

## New e-mail notifications

Your phone can automatically check your e-mail account in time intervals and issue a notification when new e-mail is received.

1. Select **Menu > Messaging > Message settings > E-mail messages > Edit mailboxes**.

2. Select your e-mail account, **Downloading sett.**, and the following options:
  - **Mailbox upd. interval** — to set how often your phone checks your e-mail account for new e-mail
  - **Automatic retrieval** — to retrieve new e-mail automatically from your e-mail account
3. To enable the new e-mail notification, select **Menu > Messaging > Message settings > E-mail messages > New e-mail notif. > On**.

## Flash messages

Flash messages are text messages that are instantly displayed upon reception.

1. To write a flash message, select **Menu > Messaging > Create message > Flash message**.
2. Enter the recipient's phone number, write your message (maximum 70 characters), and select **Send**.

## Nokia Xpress audio messages

Create and send an audio message using MMS in a convenient way.

1. Select **Menu > Messaging > Create message > Audio message**. The voice recorder opens.
2. Record your message. [See "Voice recorder," p. 40.](#)
3. Enter one or more phone numbers in the **To:** field, or select **Add** to retrieve a number.
4. To send the message, select **Send**.

## Instant messaging

With instant messaging (IM, network service) you can send short text messages to online users. You must subscribe to a service and register with the IM service you want to use. Check the availability of these services, pricing, and instructions with your service provider. The menus may vary depending on your IM provider.

To connect to the service, select **Menu > Messaging > IM** and follow the instructions on the display.

## Info messages, SIM messages and service commands

### Info messages

You can receive messages on various topics from your service provider (network service). For more information, contact your service provider.

Select **Menu > Messaging > Info messages** and from the available options.

### Service commands

Service commands allow you to write and send service requests (USSD commands) to your service provider, such as activation commands for network services.

To write and send the service request, select **Menu > Messaging > Serv. commands**. For details, contact your service provider.

### SIM messages

SIM messages are specific text messages that are saved to your SIM card. You can copy or move those messages from the SIM to the phone memory, but not vice versa.

To read SIM messages, select **Menu > Messaging > Options > SIM messages**.

## Voice messages

The voice mailbox is a network service to which you may need to subscribe. For more information, contact your service provider.

To call your voice mailbox, press and hold **1**.

To edit your voice mailbox number, select **Menu > Messaging > Voice messages > Voice mailbox no..**

## Message settings

Select **Menu > Messaging > Message settings** to set up your messaging features.

- **General settings** — to set your phone to save sent messages, to allow overwriting of older messages if the message memory is full, and to set up other preferences related to messages
- **Text messages** — to allow delivery reports, to set up message centers for SMS and SMS e-mail, to select the type of character support, and to set up other preferences related to text messages
- **Multimedia messages** — to allow delivery reports, to set up the appearance of multimedia messages, to allow the reception of multimedia messages and adverts, and to set up other preferences related to multimedia messages
- **E-mail messages** — to allow e-mail reception, to set the image size in e-mail, and to set up other preferences related to e-mail



# Contacts

You can save names, phone numbers as contacts in the phone memory and on the SIM card memory and search and recall them to make a phone call or to create a message.

## Manage contacts

### Select the memory for contacts

The phone memory can save contacts with additional details, such as various phone numbers and text items. You can also save an image, a tone, or a video clip for a limited number of contacts.

The SIM card memory can save names with one phone number attached to them. The contacts saved in the SIM card memory are indicated by .

1. Select **Menu > Contacts > Settings > Memory in use** to select the SIM card, the phone memory, or both for your contacts.
2. Select **Phone and SIM** to recall contacts from both memories. When you save contacts, they will be saved in the phone memory.

### Save names and numbers

To save a name and phone number, select **Menu > Contacts > Names > Options > Add new contact**.

### Add and edit details

The first number you save is automatically set as the default number and is indicated with a frame around the number type indicator (for example, ). When you select a name from contacts (for example, to make a call), the default number is used unless you select another number.

Search for the contact to add a detail, and select **Details > Options > Add detail** and from the available options.

### Search for a contact

Select **Menu > Contacts > Names** and scroll through the list of contacts, or enter the first characters of the name to search.

### Copy or move a contact between SIM card and phone memory

1. Select **Menu > Contacts > Names**.
2. Select the contact to copy or move and **Options > Copy contact** or **Move contact**.

### Copy or move several contacts between SIM card and phone memory

1. Select the first contact to copy or move and **Options > Mark**.
2. Mark the other contacts, and select **Options > Copy marked** or **Move marked**.

## Copy or move all contacts between SIM card and phone memory

Select **Menu** > **Contacts** > **Copy contacts** or **Move contacts**.

### Delete contacts

Search for the desired contact, and select **Options** > **Delete contact**.

To delete all the contacts and the details attached to them from the phone or SIM card memory, select **Menu** > **Contacts** > **Del. all contacts** > **From phone memory** or **From SIM card**.

To delete a number, text item, or an image attached to the contact, search for the contact, and select **Details**. Scroll to the desired detail, and select **Options** > **Delete** and from the available options.

### Create a contact group

Arrange contacts into caller groups with different ringing tones and group images.

1. Select **Menu** > **Contacts** > **Groups**.
2. Select **Add** or **Options** > **Add new group** to create a new group.
3. Enter the group name, optionally select an image and a ringing tone and select **Save**.
4. Select the group and **View** > **Add** to add contacts to the group.

## Business cards

You can send and receive a person's contact information from a compatible device that supports the vCard standard.

To send a business card, search for the contact, and select **Details** > **Options** > **Send business card**.

When you receive a business card, select **Show** > **Save** to save the business card in the phone memory.

## Assign dialing shortcuts

Assign phone numbers to the number keys 2–9 as a shortcut.

1. Select **Menu** > **Contacts** > **Speed dials**, and scroll to a number key.
2. Select **Assign**, or if a number has already been assigned to the key, select **Options** > **Change**.
3. Enter a number or search for a contact.

## Call log

To view the information on your calls, select **Menu > Log**.

- **Call log** — to view your recently missed and received calls and dialed numbers chronologically
- **Missed calls, Received calls, or Dialed numbers** — for information about your recent calls
- **Msg. recipients** — to view the contacts to whom you most recently sent messages
- **Call duration, Data counter, or Pack. data timer** — to view the general information on your recent communications
- **Message log, or Sync log** — to view the number of sent and received messages or synchronizations



**Note:** The actual invoice for calls and services from your service provider may vary, depending on network features, rounding off for billing, taxes, and so forth.

# Settings

## Profiles

Your phone has various setting groups called profiles, which you can customize with ringing tones for different events and environments.

Select **Menu > Settings > Profiles**, the desired profile, and from the following options:

- **Activate** — to activate the selected profile
- **Personalise** — to change the profile settings
- **Timed** — to set the profile to be active until an end time. When the time set for the profile expires, the previous profile that was not timed becomes active.

## Themes

A theme contains elements for personalizing your phone.

Select **Menu > Settings > Themes** and from the following options:

- **Select theme** — Open the **Themes** folder, and select a theme.
- **Theme downloads** — Open a list of links to download more themes.

## Tones

You can change the tone settings of the selected active profile.

Select **Menu > Settings > Tones**. You can find the same settings in the **Profiles** menu.

If you select the highest ringing tone level, the ringing tone reaches its highest level after a few seconds.

## Display

Select **Menu > Settings > Display** and from the available options:

- **Wallpaper** — to add a background image for the standby mode
- **Active standby** — to activate, organize, and personalize the active standby mode
- **Standby font colour** — to select the font color for the standby mode
- **Navigation key icons** — to display the icons of the scroll key shortcuts in the standby mode when active standby is off
- **Notification details** — to display details in missed call and message notifications
- **Screen saver** — to create and set a screen saver
- **Power saver** — to dim the display automatically and to display a clock when the phone is not used for a certain time
- **Sleep mode** — to switch off the display automatically when the phone is not used for a certain time
- **Font size** — to set the font size for messaging, contacts, and web pages
- **Operator logo** — to display the operator logo
- **Cell info display** — to display the cell identity, if available from the network

## Date and time

To change the clock type, time, time zone, and date settings, select **Menu** > **Settings** > **Date and time**.

When traveling to a different time zone, select **Menu** > **Settings** > **Date and time** > **Date & time settings** > **Time zone**: and scroll left or right to select the time zone of your location. The time and date are set according to the time zone and enable your phone to display the correct sending time of received text or multimedia messages.

For example, GMT +8 denotes the time zone for HK.

## My shortcuts

With personal shortcuts you get quick access to often used functions of the phone.

### Left and right selection key

To select a function from the list, select **Menu** > **Settings** > **My shortcuts** > **Left selection key** or **Right selection key**.

In the standby mode, if the left selection key is **Go to**, to activate a function, select **Go to** > **Options** and from the following options:

- **Select options** — to add or remove a function
- **Organise** — to rearrange the functions

### Other shortcuts

Select **Menu** > **Settings** > **My shortcuts** and from the following options:

- **Navigation key** — to assign other functions from a predefined list to the navigation key (scroll key).
- **Active standby key** — to select the movement of the navigation key to activate the active standby mode

## Synchronization and backup

Select **Menu** > **Settings** > **Sync and backup** and from following options.

- **Phone switch** — Synchronize or copy selected data between your phone and another phone using Bluetooth.
- **Create backup** — Create a backup of selected data to the memory card.
- **Restore backup** — Select a backup file stored on the memory card and restore it to the phone. Select **Options** > **Details** for information about the selected backup file.

## Connectivity

Your phone provides several features to connect to other devices to transmit and receive data.

### Bluetooth wireless technology

Bluetooth technology allows you to connect your phone using radio waves to a compatible Bluetooth device within 10 meters (32 feet).

This device is compliant with Bluetooth Specification 2.0 + EDR supporting the following profiles: generic

access, network access, generic object exchange, advanced audio distribution, audio video remote control, hands-free, headset, object push, file transfer, dial-up networking, SIM access, and serial port. To ensure interoperability between other devices supporting Bluetooth technology, use Nokia approved enhancements for this model. Check with the manufacturers of other devices to determine their compatibility with this device.

There may be restrictions on using Bluetooth technology in some locations. Check with your local authorities or service provider.

### Setup a Bluetooth connection

Select **Menu > Settings > Connectivity > Bluetooth** and take the following steps:

1. Select **My phone's name** and enter a name for your phone.
2. To activate Bluetooth connectivity select **Bluetooth > On**.  indicates that Bluetooth is active.
3. To connect your phone with an audio enhancement, select **Search audio enhanc.** and the device that you want to connect.
4. To connect your phone with any Bluetooth device in range, select **Paired devices > New**.

Select a device and **Pair**.

Enter a passcode (up to 16 characters) on your phone and allow the connection on the other Bluetooth device.

If you are concerned about security, turn off the Bluetooth function, or set **My phone's visibility** to

**Hidden**. Always accept only Bluetooth communication from others whom you trust.

### PC connection to the internet

Use Bluetooth to connect your compatible PC to the internet without PC Suite software. Your phone must have activated a service provider that supports internet access, and your PC has to support Bluetooth personal area network (PAN). After connecting to the network access point (NAP) service of the phone and pairing with your PC, your phone automatically opens a packet data connection to the internet.

### Packet data

General packet radio service (GPRS) is a network service that allows mobile phones to send and receive data over an internet protocol (IP)-based network.

To define how to use the service, select **Menu > Settings > Connectivity > Packet data > Packet data conn.** and from the following options:

- **When needed** — to set the packet data connection to established when an application needs it. The connection will be closed when the application is terminated.
- **Always online** — to automatically connect to a packet data network when you switch the phone on

You can connect a compatible PC to the phone by Bluetooth or USB data cable and use the phone as a modem. For details refer to Nokia PC Suite. [See "Nokia support," p. 8.](#)

## USB data cable

You can use the USB data cable to transfer data between the phone and a compatible PC or a printer supporting PictBridge.

To activate the phone for data transfer or image printing, connect the data cable and select the mode:

- **PC Suite** — to use the cable for PC Suite
- **Printing & media** — to use the phone with a PictBridge compatible printer or with a compatible PC
- **Data storage** — to connect to a PC that does not have Nokia software and use the phone as a data storage device

To change the USB mode, select **Menu > Settings > Connectivity > USB data cable** and the desired USB mode.

## Nokia PC Suite

With Nokia PC Suite you can manage your music, synchronize contacts, calendar, notes, and to-do notes between your phone and the compatible PC or a remote internet server (network service). You may find more information and PC Suite on the Nokia website.

[See "Nokia support," p. 8.](#)

## Call

Select **Menu > Settings > Call** and from the following options:

- **Call divert** — to divert your incoming calls (network service). You may not be able to divert your calls if some call barring functions are active. [See "Security," p. 32.](#)

- **Anykey answer** — to answer an incoming call by briefly pressing any key, except the power key, the left and right selection keys, or the end key
- **Automatic redial** — to make a maximum of 10 attempts to connect the call after an unsuccessful call attempt
- **Voice clarity** — to enhance speech intelligibility, especially in noisy environments
- **Speed dialling** — to dial the names and phone numbers assigned to the number keys 2 to 9 by pressing and holding the corresponding number key
- **Call waiting** — to have the network notify you of an incoming call while you have a call in progress (network service)
- **Summary after call** — to briefly display the approximate duration after each call
- **Send my caller ID** — to show your phone number to the person you are calling (network service). To use the setting agreed upon with your service provider, select **Set by network**.
- **Outgoing call line** — to select the phone line 1 or 2 for making calls if supported by your SIM card (network service)

## Phone

Select **Menu > Settings > Phone** and from the following options:

- **Language settings** — To set the display language of your phone, select **Phone language**. **Automatic** selects the language according to the information on the SIM card. To set a language for the voice commands, select **Recognition lang..**

- **Memory status** — to check the memory consumption
- **Automatic keypad** — to lock the keypad automatically after a preset time delay when the phone is in the standby mode and no function has been used.
- **Voice recognition** — [See "Voice commands," p. 31.](#)
- **Security keypad** — to ask for the security code when you unlock the keypad
- **Welcome note** — to write a note that is shown when the phone is switched on
- **Operator selection** — to set a cellular network available in your area
- **Help text activation** — to select whether the phone shows help texts
- **Start-up tone** — to let the phone plays tone when it is switched on
- **Flight query** — to let the phone ask when it is switched on whether to use the flight mode. With the flight mode, all radio connections are switched off.
- **Confirm SIM actions** — [See "SIM services," p. 48.](#)

## Voice commands

Call contacts and carry out phone functions by speaking a voice command.

Voice commands are language-dependent. Select **Menu > Settings > Phone > Language settings > Recognition lang.** and your language before using voice commands.

To train the voice recognition of your phone to your voice, select **Menu > Settings > Phone > Voice recognition > Voice recog. training.**

To activate a voice command for a function, select **Menu > Settings > Phone > Voice recognition > Voice commands**, a feature and a subsequent function.  indicates that the voice command is activated.

To activate the voice tag, select **Add**. To play the activated voice command, select **Play**.

To use voice commands, see ["Voice dialing," p.16.](#)

To manage the voice commands, scroll to a function, and select **Options** and from the following:

- **Edit or Remove** — to rename or deactivate the voice command
- **Add all or Remove all** — to activate or deactivate voice commands for all functions in the voice commands list

## Enhancements

This menu or the following options are shown only if the phone is or has been connected to a compatible mobile enhancement.

Select **Menu > Settings > Enhancements**. Select an enhancement, and an option depending on the enhancement.

## Configuration

You can configure your phone with settings that are required for certain services. Your service provider may



also send you these settings. [See "Configuration setting service," p. 8.](#)

Select **Menu** > **Settings** > **Configuration** and from the following options:

- **Default config. sett.** — to view the service providers saved in the phone and set a default service provider
- **Activ. def. in all apps.** — to activate the default configuration settings for supported applications
- **Preferred access pt.** — to view the saved access points
- **Connect to support** — to download the configuration settings from your service provider
- **Personal config. sett.** — to manually add new personal accounts for various services and to activate or delete them. To add a new personal account, select **Add**, or **Options** > **Add new**. Select the service type, and enter the required parameters. To activate a personal account, scroll to it, and select **Options** > **Activate** .

## Security

When security features that restrict calls are in use (such as call barring, closed user group, and fixed dialling), calls may be possible to the official emergency number programmed into your device.

Select **Menu** > **Settings** > **Security** and from the following options:

- **PIN code request** or **UPIN code request** — to request for your PIN or UPIN code every time the phone is switched on. Some SIM cards do not allow the code request to be turned off.

- **PIN2 code request** — to select whether the PIN2 code is required when using a specific phone feature which is protected by the PIN2 code. Some SIM cards do not allow the code request to be turned off.
- **Call barring service** — to restrict incoming calls to and outgoing calls from your phone (network service). A barring password is required.
- **Fixed dialling** — to restrict your outgoing calls to selected phone numbers if supported by your SIM card. When the fixed dialling is on, GPRS connections are not possible except while sending text messages over a GPRS connection. In this case, the recipient's phone number and the message center number must be included in the fixed dialling list.
- **Closed user group** — to specify a group of people whom you can call and who can call you (network service)
- **Security level** — Select **Phone** to request the security code whenever a new SIM card is inserted into the phone. Select **Memory**, to request the security code when the SIM card memory is selected, and you want to change the memory in use.
- **Access codes** — to change the security code, PIN code, UPIN code, PIN2 code, or barring password
- **Code in use** — to select whether the PIN code or UPIN code should be active
- **Authority certificates** or **User certificates** — to view the list of the authority or user certificates downloaded into your phone. [See "Certificates," p. 47.](#)
- **Security module sett.** — to view **Secur. module details**, activate **Module PIN request**, or change the module PIN and signing PIN. [See "Access codes," p. 8.](#)

## Restore factory settings

To restore the phone back to factory conditions, select **Menu > Settings > Rest. factory sett.** and from the following options:

- **Restore settings only** — to reset all preference settings without deleting any personal data
- **Restore all** — to reset all preference settings and delete all personal data, such as contacts, messages, media files and activation keys

## Operator menu

Access a portal to services provided by your network operator. For more information contact your network operator. The operator can update this menu with a service message. [See "Service inbox," p. 46.](#)

# Gallery

Manage images, video clips, music files, themes, graphics, tones, recordings, and received files. These files are stored in the phone memory or an attached memory card and may be arranged in folders.

Copyright protections may prevent some images, music (including ringing tones), and other content from being copied, modified, transferred or forwarded.

Your phone supports an activation key system to protect acquired content. Always check the delivery terms of any content and activation key before acquiring them, as they may be subject to a fee.

## Folders and files

To view the list of folders, select **Menu** > **Gallery**. To view the list of files in a folder, select a folder and **Open**. To view the folders of the memory card when moving a file, scroll to the memory card, and press the scroll key right.

## Print images

Your phone supports Nokia XPressPrint to print images that are in the jpeg format.

1. To connect your phone to a compatible printer, use a data cable or send the image by Bluetooth to a printer supporting Bluetooth technology. [See "Bluetooth wireless technology," p. 28.](#)
2. Select the image you want to print and **Options** > **Print**.

## Memory card

Use a memory card to store your multimedia files such as video clips, music tracks, sound files, images, and messaging data.



**Warning:** Keep all memory cards out of the reach of small children.

Some of the folders in **Gallery** with content that the phone uses (for example, **Themes**) may be stored on the memory card.

To insert and remove a memory card see "[Insert a microSD card](#)", p. [10](#) and "[Remove the microSD card](#)", p. [11](#).

### Format the memory card

Some supplied memory cards are preformatted; others require formatting. When you format a memory card, all data on the card is permanently lost.

1. To format a memory card, select **Menu** > **Gallery** or **Applications**, the memory card folder , and **Options** > **Format memory card** > **Yes**.
2. When formatting is complete, enter a name for the memory card.

### Lock the memory card

Set a password (maximum 8 characters) to lock your memory card against unauthorized use.

Select the memory card folder  and **Options** > **Set password**.

The password is stored in your phone, and you do not have to enter it again while you are using the memory card on the same phone. If you want to use the memory card on another device, you are asked for the password.

To remove the password, select **Options > Delete password**.

### **Check memory consumption**

Check the memory consumption of different data groups and the available memory to install new software on your memory card.

Select the memory card  and **Options > Details**.

# Media

## Camera and video

Take images or record video clips with the built-in camera.

### Take a picture

To use the still picture function, select **Menu** > **Media** > **Camera** or if the video function is on, scroll left or right.

To zoom in and out in the camera mode, scroll up and down or press the volume keys.

To take a picture, select **Capture**. The phone saves the pictures on the memory card, if available, or on the phone memory.

Select **Options** > **Settings** > **Image preview time** and a preview time to display the taken pictures. During the preview time, select **Back** to take another picture or **Send** to send the picture as a multimedia message.

Your phone supports a picture capture resolution up to 1600 x 1200 pixels.

### Record a video clip

To activate the video function, select **Menu** > **Media** > **Video**; or if the camera function is on, scroll left or right.

To start the video recording, select **Record**; to pause the recording, select **Pause**; to resume the recording, select **Continue**; to stop the recording, select **Stop**.

The phone saves the video clips on the memory card, if available, or in the phone memory.

### Camera and video options

To use a filter, select **Options** > **Effects**.

To adapt the camera to the light conditions, select **Options** > **White balance**.

To change other camera and video settings and to select the image and video storage, select **Options** > **Settings**.

## Music player

Your phone includes a music player for listening to music tracks or other MP3 or AAC sound files that you have downloaded from the web or transferred to the phone with Nokia PC Suite. See "[Nokia PC Suite](#)," p. 30. You can also view your recorded or downloaded video clips.

Music and video files stored in the music folder in the phone memory or on the memory card are automatically detected and added to the music library during the startup of the phone.

To open the music player, select **Menu** > **Media** > **Music player**.

### Music menu

Access your music and video files stored on the phone memory or the memory card, download music or video

clips from the web, or view compatible video streams from a network server (network service).

To listen to music or play a video clip, select a file from **Playlists**, **Artists**, **Albums**, or **Genres**, and select **Play**.

To download files from the web, select **Options** > **Downloads** and a download site.

To update the music library after you have added files, select **Options** > **Update library**.

### Create a playlist

To create a playlist with your selection of music, do the following:

1. Select **Playlists** > **Create playlist**, and enter the name of the playlist.
2. Add music or video clips from the displayed lists.
3. Select **Done** to store the playlist.

### Configuration for a streaming service

You may receive the configuration settings required for streaming as a configuration message from the service provider. [See "Configuration setting service," p. 8.](#) You can also enter the settings manually. [See "Configuration," p. 31.](#)

To activate the settings, do the following:

1. Select **Options** > **Downloads** > **Streaming settings** > **Configuration**.
2. Select a service provider, **Default**, or **Personal config.** for streaming.
3. Select **Account** and a streaming service account contained in the active configuration settings.

## Play music tracks



**Warning:** Listen to music at a moderate level. Continuous exposure to high volume may damage your hearing. Do not hold the device near your ear when the loudspeaker is in use, because the volume may be extremely loud.

To adjust the volume level, press the volume keys of the phone.

Operate the music player with the music player keys or similarly with the virtual keys on the display.

To start or pause playing, press **▶||**.

To skip to the next track, press **▶▶**. To skip to the beginning of the previous track, press **◀◀** twice.

To fast forward the current track, press and hold **▶▶**. To rewind the current track, press and hold **◀◀**. Release the key at the position you want to continue the music playback.

To stop the music player, press and hold the end key.

In the music player menu you can use following shortcuts:

To switch to the music menu, select **≡**.

To switch to the current playlist, select **(•••)**.

To stop the music player, press and hold the end key.

## Change the music player look

Your phone provides several themes to change the look of the music player.

Select **Menu** > **Media** > **Music player** > **Go to Music player** > **Options** > **Settings** > **Music player**

**theme** and one of the listed themes. The virtual keys may change depending on the theme.

## Radio





The FM radio depends on an antenna other than the wireless device antenna. A compatible headset or enhancement needs to be attached to the device for the FM radio to function properly.



**Warning:** Listen to music at a moderate level. Continuous exposure to high volume may damage your hearing. Do not hold the device near your ear when the loudspeaker is in use, because the volume may be extremely loud.





To adjust the volume, press the volume keys.

Select **Menu > Media > Radio**.

To use the graphical keys , , , or  on the display, scroll left or right to the desired key, and select it.

## Tune in to radio stations



### Search and save stations

1. To start the search, select and hold  or . To change the radio frequency in 0.05 MHz steps, briefly press  or .
2. To save a station to a memory location, select **Options > Save station**.
3. To enter the name of the radio station, select **Options > Stations > Options > Rename**.

Select **Options** and from the following.

- **Search all stations** — to automatically search the available stations at your location
- **Set frequency** — to enter the frequency of the desired radio station
- **Station directory** — to access a website with a list of radio stations
- **Save station** — to save the currently tuned in station
- **Stations** — to list and rename or delete saved stations

### Change stations

Select  or , or press the corresponding number keys.

## Radio features

Select **Options > Settings** to switch off the radio, swap between headset and loudspeaker, and switch between stereo and mono output. Select **RDS on** to display information from the radio data system of the tuned in station. Select **Auto-freq. change on** to enable the automatic switch to a frequency with the best reception of the tuned in station.

### Visual radio

Some radio stations may send text or graphical information that you can view using the Visual Radio application (network service). To check the availability and costs, contact your service provider.

To set the Visual service ID of a station select **Options > Stations** and a station. Select **Options > Visual service ID** and enter the ID.



Select **Options > Visual Radio** to start Visual radio.





Select **Options** > **Enable visual service** to start Visual Radio automatically or after confirmation when you turn on the radio.

## Voice recorder

Record speech, sound, or an active call, and save them in **Gallery**.

Select **Menu** > **Media** > **Voice recorder**. To use the graphical keys , , or  on the display, scroll left or right.

### Record sound

1. Select , or during a call, select **Options** > **Record**. While recording a call, all parties to the call hear a faint beeping. To pause the recording, select .
2. To end the recording, select . The recording is saved in **Gallery** > **Recordings**.

Select **Options** to play or send the last recording, to access the list of recordings and to select the memory and the folder to store the recordings.

## Equalizer

Adjust the sound when using the music player.

Select **Menu** > **Media** > **Equaliser**.

To activate a predefined set, scroll to one of the equalizer sets and select **Activate**.

### Create a personal equalizer set

1. Select one of the last two sets in the list and **Options** > **Edit**.

2. Scroll left or right to access the virtual sliders and up or down to adjust the slider.
3. Select **Save** and **Options** > **Rename** to save the settings with a name.

## Push to talk

Push to talk (PTT) is a two-way radio service available over a GPRS cellular network (network service).

You can use PTT to have a conversation with one person or with a group of people (channel) having compatible phones. While you are connected to the PTT service, you can use the other functions of the phone.

To check availability, costs, additional features and to subscribe to the service, contact your service provider. Roaming services may be more limited than for normal calls. This feature may not be available, depending on your phone.

For more information about signing up for the PTT services and the usage, contact your service provider.

To connect to the PTT service, select **Menu > Push to talk > Switch PTT on.**

# Applications

You can manage applications and games. Your phone may have some games or applications installed. These files are stored in the phone memory or an attached memory card and may be arranged in folders. [See "Memory card," p. 35.](#)

## Launch an application

Select **Menu > Applications > Games, Memory card, or Collection**. Scroll to a game or an application, and select **Open**.

To set sounds, lights, and shakes for a game, select **Menu > Applications > Options > Application settings**.

Other available options may include the following:

- **Update version** — to verify that a new version of the application is available for download from the web (network service)
- **Web page** — to provide further information or additional data for the application from an internet page (network service), if available
- **Application access** — to restrict the application from accessing the network

## Download an application

Your phone supports J2ME Java applications. Ensure that the application is compatible with your phone before downloading it.



**Important:** Only install and use applications and other software from trusted sources, such as applications that are Symbian Signed or have passed the Java Verified™ testing.

You can download new applications and games in different ways.

- Select **Menu > Applications > Options > Downloads > App. downloads** or **Game downloads**; the list of available bookmarks is shown.
- Use the Nokia Application Installer from PC Suite to download the applications to your phone.

For the availability of different services and pricing, contact your service provider.

Your device may have some bookmarks or links preinstalled for or may allow access to sites provided by third parties not affiliated with Nokia. Nokia does not endorse or assume any liability for these sites. If you choose to access them, you should take the same precautions, for security or content, as you would with any internet site.

# Organizer

## Alarm clock

To sound an alarm at a desired time.

### Set the alarm

1. Select **Menu** > **Organiser** > **Alarm clock**.
2. Set the alarm on and enter the alarm time.
3. To issue an alarm on selected days of the week, select **Repeat: On** and the days.
4. Select the alarm tone. If you select the radio as an alarm tone, connect the headset to the phone.
5. Set the snooze time-out and select **Save**.

### Stop the alarm

If the alarm time is reached while the device is switched off, the device switches itself on and starts sounding the alarm tone. If you select **Stop**, the device asks whether you want to activate the device for calls. Select **No** to switch off the device or **Yes** to make and receive calls. Do not select **Yes** when wireless device use may cause interference or danger.

To stop the alarm, select **Stop**. If you let the phone continue to sound the alarm for a minute or select **Snooze**, the alarm stops for the snooze time-out, then resumes.

## Calendar

Select **Menu** > **Organiser** > **Calendar**.





The current day has a frame around the number. If there are any notes set for the day, the day is in bold

type. To view the day notes, select **View**. To view a week, select **Options** > **Week view**. To delete all notes in the calendar, select the month or week view, and **Options** > **Delete notes** > **All notes**.

Select **Options** > **Settings** to set the date, time, time zone, date or time format, date separator, default view, or the first day of the week. Select **Options** > **Auto-delete notes** to delete old notes automatically after a specified time.

### Make a calendar note

Scroll to the date, and select **Options** > **Make a note** and one of the following note types: 

**Reminder**,  **Meeting**,  **Call**,  **Birthday**, or  **Memo**. Fill in the fields.

## To-do list

To save a note for a task that you must do, select **Menu** > **Organiser** > **To-do list**.

To make a note if no note is added, select **Add**; otherwise, select **Options** > **Add**. Fill in the fields, and select **Save**.

To view a note, scroll to it, and select **View**. Select **Options** to edit the attributes, to delete the selected note and all notes that you have marked as done.

## Notes

To write and send notes, select **Menu > Organiser > Notes**.

To make a note if no note is added, select **Add**; otherwise, select **Options > Make a note**. Write the note, and select **Save**.

## Calculator

The calculator in your phone provides a standard, a scientific, and a loan calculator.

Select **Menu > Organiser > Calculator**, the calculator type, and from the available options that also include the operating instructions.



**Note:** This calculator has limited accuracy and is designed for simple calculations.

## Timers

### Countdown timer

1. To activate the countdown timer, select **Menu > Organiser > Countd. timer > Normal timer**, enter the alarm time, and write a note that is displayed when the time expires. To change the countdown time, select **Change time**.
2. To start the timer, select **Start**.
3. To stop the timer, select **Stop timer**.

### Interval timer

1. To have an interval timer with up to 10 intervals started, first enter the intervals.

2. Select **Menu > Organiser > Countd. timer > Interval timer**.
3. To start the timer, select **Start timer > Start**.

## Stopwatch

You can measure time, take intermediate times, or take lap times using the stopwatch.

Select **Menu > Organiser > Stopwatch** and from the following options:

- **Split timing** — to take intermediate times. To reset the time without saving it, select **Options > Reset**.
- **Lap timing** — to take lap times
- **Continue** — to view the timing that you have set in the background
- **Show last** — to view the most recently measured time if the stopwatch is not reset
- **View times** or **Delete times** — to view or delete the saved times

To set the stopwatch timing in the background, press the end key.

## Web

You can access various mobile internet services with your phone browser. Appearance may vary due to screen size. You may not be able to view all details of the internet pages.



**Important:** Use only services that you trust and that offer adequate security and protection against harmful software.

The XHTML browser in this device supports the Unicode encoding format.

Check the availability of these services, pricing, and instructions with your service provider.

You may receive the configuration settings required for browsing as a configuration message from the service provider. [See "Configuration setting service," p. 8.](#)

To set a service, select **Menu > Web > Settings > Configuration sett.**, and select a configuration and an account.

## Connect to a service

To make a connection to the service, select **Menu > Web > Home**; or in the standby mode, press and hold **0**.

To select a bookmark, select **Menu > Web > Bookmarks**. Your device may have some bookmarks or links preinstalled for or may allow access to sites provided by third parties not affiliated with Nokia. Nokia does not endorse or assume any liability for

these sites. If you choose to access them, you should take the same precautions, for security or content, as you would with any internet site.

To select the last URL, select **Menu > Web > Last web addr.**

To enter an address of a service, select **Menu > Web > Go to address**. Enter the address, and select **OK**.

After you make a connection to the service, you can start browsing its pages. The function of the phone keys may vary in different services. Follow the text guides on the phone display. For more information, contact your service provider.

## Appearance settings

While browsing, select **Options > Other options > Appearance settings**; or in the standby mode, select **Menu > Web > Settings > Appearance settings**. Available options may include the following:

- **Text wrapping** — to select how the text is displayed
- **Alerts** — Select **Alert for unsec. conn.** > **Yes** to alert when a secure connection changes to an unsecure connection while browsing.
- **Alerts** — Select **Alert for unsec. items** > **Yes** to alert when a secure page contains an unsecure item. These alerts do not guarantee a secure connection. [See "Browser security," p. 46.](#)
- **Character encoding** — Select **Content encoding** to set the encoding for the browser page content.

## Security settings

### Cache memory

A cache is a memory location that is used to store data temporarily, such as passwords and cookies. If you have tried to access or have accessed confidential information requiring passwords, empty the cache after each use. A cookie is data that a site saves in the cache memory of your phone. Cookies are saved until you clear the cache memory.

To clear the cache while browsing, select **Options** > **Other options** > **Clear the cache**. To allow or prevent the phone from receiving cookies, while browsing select **Options** > **Other options** > **Security** > **Cookie settings**; or in the standby mode select **Menu** > **Web** > **Settings** > **Security settings** > **Cookies**.

### Scripts over secure connection

You can select whether to run scripts from a secure page. The phone supports WML scripts.

While browsing, to allow the scripts, select **Options** > **Other options** > **Security** > **WMLScript settings**; or in the standby mode, select **Menu** > **Web** > **Settings** > **Security settings** > **WMLScripts in conn.** > **Allow**.

### Service inbox

The phone is able to receive service messages sent by your service provider (network service). Service messages are notifications (for example, news

headlines) that may contain a text message or an address of a service.

Select **Show** to access the **Service inbox** when you receive a service message. If you select **Exit**, the message is moved to the **Service inbox**.

To access the **Service inbox** later, select **Menu** > **Web** > **Service inbox**. To access the **Service inbox** while browsing, select **Options** > **Other options** > **Service inbox**. To activate the browser and download the complete message, select the message and **Retrieve**.

To change the service inbox settings, select **Menu** > **Web** > **Settings** > **Service inbox sett.** and from the following options:

- **Service messages** — to set whether you want to receive service messages
- **Message filter** — Select **On** to receive service messages only from content authors approved by the service provider.
- **Autom. connection** — Select **On** to automatically activate the browser from the standby mode, when the phone has received a service message. If you select **Off**, the phone activates the browser only after you select **Retrieve** when the phone has received a service message.

### Browser security

Security features may be required for some services, such as online banking or shopping. For such connections you need security certificates and possibly a security module, which may be available on your SIM

card. For more information, contact your service provider.

To view or change the security module settings, select **Menu > Settings > Security > Security module sett..**

## Certificates



**Important:** Even if the use of certificates makes the risks involved in remote connections and software installation considerably smaller, they must be used correctly in order to benefit from increased security. The existence of a certificate does not offer any protection by itself; the certificate manager must contain correct, authentic, or trusted certificates for increased security to be available. Certificates have a restricted lifetime. If "Expired certificate" or "Certificate not valid yet" is shown, even if the certificate should be valid, check that the current date and time in your device are correct.

There are three kinds of certificates: server certificates, authority certificates, and user certificates. You may receive these certificates from your service provider. Authority certificates and user certificates may also be saved in the security module by your service provider.

To view the list of the authority or user certificates downloaded to your phone, select **Menu > Settings > Security > Authority certificates** or **User certificates**.

During a connection if the data transmission between the phone and the content server is encrypted,  is displayed.

The security icon does not indicate that the data transmission between the gateway and the content server (or place where the requested resource is stored) is secure. The service provider secures the data transmission between the gateway and the content server.

## Digital signature

You can create digital signatures with your phone if your SIM card has a security module. The digital signature is the same as signing your name to a paper bill, contract, or other document.

To create a digital signature, select a link on a page, for example, the title of the book you want to buy and its price. The text to be signed is shown and may include the amount and date.

Check that the header text is **Read** and that the digital signature icon  is shown. If the digital signature icon does not appear, there is a security breach; do not enter any personal data (such as your signing PIN).

To sign the text, read all of the text first, and select **Sign**. The text may not fit within a single screen. Therefore, make sure to scroll through and read all of the text before signing.

Select the user certificate you want to use, and enter the signing PIN. The digital signature icon disappears, and the service may display a confirmation of your purchase.



## SIM services

Your SIM card may provide additional services. You can access this menu only if it is supported by your SIM card. The name and contents of the menu depend on the available services.

For availability and information on using SIM card services, contact your SIM card vendor. This may be the service provider or other vendor.

To show the confirmation messages sent between your phone and the network when you are using the SIM services, select **Menu > Settings > Phone > Confirm SIM actions**

Accessing these services may involve sending messages or making a phone call for which you may be charged.

## Genuine enhancements



**Warning:** Use only batteries, chargers, and enhancements approved by Nokia for use with this particular model. The use of any other types may invalidate any approval or warranty, and may be dangerous.

A new extensive range of enhancements is available for your device. Select the enhancements that accommodate your specific communication needs.

For the compatible enhancements related to this mobile phone, please visit [www.nokia.com.hk](http://www.nokia.com.hk).



## Enhancements

Practical rules about accessories and enhancements

- Keep all accessories and enhancements out of the reach of small children.
- When you disconnect the power cord of any accessory or enhancement, grasp and pull the plug, not the cord.
- Check regularly that enhancements installed in a vehicle are mounted and are operating properly.
- Installation of any complex car enhancements must be made by qualified personnel only.

## Battery

| Type   | Talk time | Standby         |
|--------|-----------|-----------------|
| BL-4CT | 5 hours   | Up to 12.5 days |



**Important:** These battery talk and standby times can only be reached in certain optimized network conditions or surroundings. The actual battery talk and standby times may differ depending on SIM card, features used, battery age and condition, temperatures to which battery is exposed, different network conditions, and many other factors, so that the talk and standby times may be significantly shorter than given here. In addition, ringing tones, handsfree, use in digital mode, and other functions consume the power, and the amount of time a device is used for calls will affect its standby time. Likewise, the amount of time that the device is turned on and in the standby mode will affect its talk time.

# Battery information

## Charging and discharging

Your device is powered by a rechargeable battery. The battery can be charged and discharged hundreds of times, but it will eventually wear out. When the talk and standby times are noticeably shorter than normal, replace the battery. Use only Nokia approved batteries, and recharge your battery only with Nokia approved chargers designated for this device.

If a replacement battery is being used for the first time or if the battery has not been used for a prolonged period, it may be necessary to connect the charger, then disconnect and reconnect it to begin charging the battery.

Unplug the charger from the electrical plug and the device when not in use. Do not leave a fully charged battery connected to a charger, since overcharging may shorten its lifetime. If left unused, a fully charged battery will lose its charge over time.

If the battery is completely discharged, it may take several minutes before the charging indicator appears on the display or before any calls can be made.

Use the battery only for its intended purpose. Never use any charger or battery that is damaged.

Do not short-circuit the battery. Accidental short-circuiting can occur when a metallic object such as a coin, clip, or pen causes direct connection of the positive (+) and negative (-) terminals of the battery. (These look like metal strips on the battery.) This might happen, for example, when you carry a spare battery

in your pocket or purse. Short-circuiting the terminals may damage the battery or the connecting object.

Leaving the battery in hot or cold places, such as in a closed car in summer or winter conditions, will reduce the capacity and lifetime of the battery. Always try to keep the battery between 15°C and 25°C (59°F and 77°F). A device with a hot or cold battery may not work temporarily, even when the battery is fully charged. Battery performance is particularly limited in temperatures well below freezing.

Do not dispose of batteries in a fire as they may explode. Batteries may also explode if damaged. Dispose of batteries according to local regulations. Please recycle when possible. Do not dispose as household waste.

Do not dismantle or shred cells or batteries. In the event of a battery leak, do not allow the liquid to come in contact with the skin or eyes. In the event of such a leak, flush your skin or eyes immediately with water, or seek medical help.

## Nokia battery authentication guidelines

Always use original Nokia batteries for your safety. To check that you are getting an original Nokia battery, purchase it from an authorised Nokia dealer, and inspect the hologram label using the following steps:

Successful completion of the steps is not a total assurance of the authenticity of the battery. If you have

any reason to believe that your battery is not an authentic, original Nokia battery, you should refrain from using it, and take it to the nearest authorised Nokia service point or dealer for assistance. Your authorised Nokia service point or dealer will inspect the battery for authenticity. If authenticity cannot be verified, return the battery to the place of purchase.

## Authenticate hologram

1. When you look at the hologram on the label, you should see the Nokia connecting hands symbol from one angle and the Nokia Original Enhancements logo when looking from another angle.
2. When you angle the hologram left, right, down and up, you should see 1, 2, 3 and 4 dots on each side respectively.

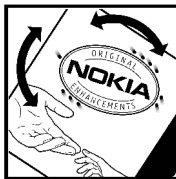
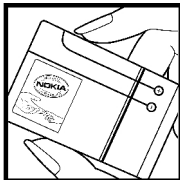

## What if your battery is not authentic?

If you cannot confirm that your Nokia battery with the hologram on the label is an authentic Nokia battery, please do not use the battery. Take it to the nearest authorised Nokia service point or dealer for assistance. The use of a battery that is not approved by the manufacturer may be dangerous and may result in poor performance and damage to your device and its

enhancements. It may also invalidate any approval or warranty applying to the device.

To find out more about original Nokia batteries, visit [www.nokia.com/battery](http://www.nokia.com/battery).

## Care and maintenance

Your device is a product of superior design and craftsmanship and should be treated with care. The following suggestions will help you protect your warranty coverage.

- Keep the device dry. Precipitation, humidity, and all types of liquids or moisture can contain minerals that will corrode electronic circuits. If your device does get wet, remove the battery, and allow the device to dry completely before replacing it.
- Do not use or store the device in dusty, dirty areas. Its moving parts and electronic components can be damaged.
- Do not store the device in hot areas. High temperatures can shorten the life of electronic devices, damage batteries, and warp or melt certain plastics.
- Do not store the device in cold areas. When the device returns to its normal temperature, moisture can form inside the device and damage electronic circuit boards.
- Do not attempt to open the device other than as instructed in this guide.
- Do not drop, knock, or shake the device. Rough handling can break internal circuit boards and fine mechanics.
- Do not use harsh chemicals, cleaning solvents, or strong detergents to clean the device.
- Do not paint the device. Paint can clog the moving parts and prevent proper operation.

- Use a soft, clean, dry cloth to clean any lenses, such as camera, proximity sensor, and light sensor lenses.
- Use only the supplied or an approved replacement antenna. Unauthorized antennas, modifications, or attachments could damage the device and may violate regulations governing radio devices.
- Use chargers indoors.
- Always create a backup of data you want to keep, such as contacts and calendar notes.
- To reset the device from time to time for optimum performance, power off the device and remove the battery.

These suggestions apply equally to your device, battery, charger, or any enhancement. If any device is not working properly, take it to the nearest authorized service facility for service.

# Additional safety information

## Small children

Your device and its enhancements may contain small parts. Keep them out of the reach of small children.

## Operating environment

This device meets RF exposure guidelines when used either in the normal use position against the ear or when positioned at least 1.0 centimeters (3/8 inches) away from the body. When a carry case, belt clip, or holder is used for body-worn operation, it should not contain metal and should position the device the above-stated distance from your body.

To transmit data files or messages, this device requires a quality connection to the network. In some cases, transmission of data files or messages may be delayed until such a connection is available. Ensure the above separation distance instructions are followed until the transmission is completed.

## Medical devices

Operation of any radio transmitting equipment, including wireless phones, may interfere with the functionality of inadequately protected medical devices. Consult a physician or the manufacturer of the medical device to determine if they are adequately shielded from external RF energy or if you have any questions. Switch off your device in health care facilities when any regulations posted in these areas instruct you to do so. Hospitals or health care facilities

may be using equipment that could be sensitive to external RF energy.

## Implanted medical devices

Manufacturers of medical devices recommend that a minimum separation of 15.3 centimeters (6 inches) should be maintained between a wireless device and an implanted medical device, such as a pacemaker or implanted cardioverter defibrillator, to avoid potential interference with the medical device. Persons who have such devices should:

- Always keep the wireless device more than 15.3 centimeters (6 inches) from the medical device when the wireless device is turned on.
- Not carry the wireless device in a breast pocket.
- Hold the wireless device to the ear opposite the medical device to minimize the potential for interference.
- Turn the wireless device off immediately if there is any reason to suspect that interference is taking place.
- Read and follow the directions from the manufacturer of their implanted medical device.

If you have any questions about using your wireless device with an implanted medical device, consult your health care provider.

## Hearing aids

Some digital wireless devices may interfere with some hearing aids. If interference occurs, consult your service provider.

## Vehicles

RF signals may affect improperly installed or inadequately shielded electronic systems in motor vehicles such as electronic fuel injection systems, electronic antiskid (antilock) braking systems, electronic speed control systems, and air bag systems. For more information, check with the manufacturer, or its representative, of your vehicle or any equipment that has been added.

Only qualified personnel should service the device or install the device in a vehicle. Faulty installation or service may be dangerous and may invalidate any warranty that may apply to the device. Check regularly that all wireless device equipment in your vehicle is mounted and operating properly. Do not store or carry flammable liquids, gases, or explosive materials in the same compartment as the device, its parts, or enhancements. For vehicles equipped with an air bag, remember that air bags inflate with great force. Do not place objects, including installed or portable wireless equipment in the area over the air bag or in the air bag deployment area. If in-vehicle wireless equipment is improperly installed and the air bag inflates, serious injury could result.

Using your device while flying in aircraft is prohibited. Switch off your device before boarding an aircraft. The use of wireless teledevices in an aircraft may be

dangerous to the operation of the aircraft, disrupt the wireless telephone network, and may be illegal.

## Potentially explosive environments

Switch off your device when in any area with a potentially explosive atmosphere, and obey all signs and instructions. Potentially explosive atmospheres include areas where you would normally be advised to turn off your vehicle engine. Sparks in such areas could cause an explosion or fire resulting in bodily injury or even death. Switch off the device at refuelling points such as near gas pumps at service stations. Observe restrictions on the use of radio equipment in fuel depots, storage, and distribution areas; chemical plants; or where blasting operations are in progress. Areas with a potentially explosive atmosphere are often, but not always, clearly marked. They include below deck on boats, chemical transfer or storage facilities and areas where the air contains chemicals or particles such as grain, dust, or metal powders. You should check with the manufacturers of vehicles using liquefied petroleum gas (such as propane or butane) to determine if this device can be safely used in their vicinity.

## Emergency calls



**Important:** Wireless phones, including this device, operate using radio signals, wireless networks, landline networks, and user-programmed functions. Because of this, connections in all conditions cannot be guaranteed. You should never rely solely on any

wireless device for essential communications like medical emergencies.

To make an emergency call:

1. If the device is not on, switch it on. Check for adequate signal strength.  
Some networks may require that a valid SIM card is properly inserted in the device.
2. Press the end key as many times as needed to clear the display and ready the device for calls.
3. Enter the official emergency number for your present location. Emergency numbers vary by location.
4. Press the call key.

If certain features are in use, you may first need to turn those features off before you can make an emergency call. Consult this guide or your service provider for more information.

When making an emergency call, give all the necessary information as accurately as possible. Your wireless device may be the only means of communication at the scene of an accident. Do not end the call until given permission to do so.

## **CERTIFICATION INFORMATION (SAR)**

**This mobile device meets guidelines for exposure to radio waves.**

Your mobile device is a radio transmitter and receiver. It is designed not to exceed the limits for exposure to radio waves recommended by international guidelines. These guidelines were developed by the

independent scientific organization ICNIRP and include safety margins designed to assure the protection of all persons, regardless of age and health.

The exposure guidelines for mobile devices employ a unit of measurement known as the Specific Absorption Rate or SAR. The SAR limit stated in the ICNIRP guidelines is 2.0 watts/kilogram (W/kg) averaged over 10 grams of tissue. Tests for SAR are conducted using standard operating positions with the device transmitting at its highest certified power level in all tested frequency bands. The actual SAR level of an operating device can be below the maximum value because the device is designed to use only the power required to reach the network. That amount changes depending on a number of factors such as how close you are to a network base station. The highest SAR value under the ICNIRP guidelines for use of the device at the ear is 1.07 W/kg.

Use of device accessories and enhancements may result in different SAR values. SAR values may vary depending on national reporting and testing requirements and the network band. Additional SAR information may be provided under product information at [www.nokia.com](http://www.nokia.com).



## Limited Warranty

Nokia Corporation, represented by its Mobile Phones Division ("Nokia") warrants that this Nokia cellular product and/or genuine Nokia accessory ("Product") is free from defects in material and workmanship, according to the following terms and conditions:

1. The limited warranty for the cellular phone, data product and all genuine Nokia accessories (except battery packs) extends for the first twelve (12) months beginning on the date of purchase of the Product.
2. The limited warranty for genuine Nokia battery packs extends for the first six (6) months beginning on the date of purchase of the Product.
3. The limited warranty extends only to the original consumer purchaser ("Consumer") of the Product and is not assignable or transferable to any subsequent purchaser/end user.
4. The limited warranty extends only to Consumers who purchase the Product in one of the countries (or areas) set forth at the end of this document. The limited warranty is only valid in Nokia's intended country (or area) of sale of the Product.
5. During the limited warranty period, Nokia or its authorized service network will repair or replace, at Nokia's option, any defective Product or parts thereof with new or factory rebuilt replacement items, and return the Product to the Consumer in working condition. No charge will be made to the Consumer for either parts or labor in repairing or replacing the Product. All replaced parts, boards or equipment shall become property of Nokia. The external housing and cosmetic parts shall be free of defects at the time of shipment and, therefore, shall not be covered under these limited warranty terms.
6. Repaired Product will be warranted for the balance of the original warranty period or for ninety (90) days from the date of repair, whichever is longer.
7. Upon request from Nokia or its authorized service center, the Consumer must provide purchase receipt or other information to prove the date and place of purchase.
8. Transportation, delivery and handling charges incurred in the transport of the Product to and from Nokia or its authorized service center will be borne by the Consumer.
9. The Consumer shall have no coverage or benefits under this limited warranty if any of the following conditions are applicable:
  - a) The Product has been subject to: abnormal use, abnormal condition, improper storage, exposure to moisture or dampness, exposure to excessive temperature or other such environmental conditions, unauthorized modifications, unauthorized connections, unauthorized repair including but not limited to use of unauthorized spare parts in repairs, misuse, neglect, abuse, accident, alteration, improper installation, Acts of God, spill of foods or liquids, maladjustment of customer controls

or other acts which are beyond of reasonable control of Nokia, including deficiencies in consumable parts such as fuses and breakage or damage to antennas, unless caused directly by defects in materials or workmanship, and normal wear and tear of the Product.

- b) Nokia was not notified by Consumer of the alleged defect or malfunction of the Product during the applicable limited warranty period.
  - c) The Product serial number or the accessory date code has been removed, defaced or altered.
  - d) The defect or damage was caused by defective function of the cellular system or by inadequate signal reception by the external antenna.
  - e) The Product was used with or connected to accessory not supplied by Nokia, not fit for use with Nokia cellular phones or used in other than its intended use.
  - f) The battery was short circuited or seals of the battery enclosure or cells are broken or show evidence of tampering or the battery was used in equipment other than for which it has been specified.
10. If a problem develops during the limited warranty period, the Consumer should take the following step-by-step procedure:
- a) The Consumer shall return the Product to the place of purchase for repair or replacement processing.

- b) If "a" is not convenient, the Consumer may contact the local Nokia office for the location of the nearest authorized service center.
  - c) The Consumer shall arrange for the Product to be delivered to the authorized service center. Expenses related to removing the Product from an installation are not covered under this limited warranty.
  - d) The Consumer will be billed for any parts or labor charges not covered by this limited warranty. The Consumer shall be responsible for expenses related to reinstallation of the Product.
  - e) In case of certain operator specific features in the Product such as SIM-lock, Nokia reserves the right to refer the Consumer to the relevant cellular operator before service will be provided.
  - f) If the Product is returned to Nokia after the expiration of the warranty period, Nokia's normal service policies shall apply and the Consumer will be charged accordingly.
11. ANY IMPLIED WARRANTY OF MERCHANTABILITY, OR FITNESS FOR A PARTICULAR PURPOSE OR USE, SHALL BE LIMITED TO THE DURATION OF THE FOREGOING WRITTEN WARRANTY. OTHERWISE, THE FOREGOING WARRANTY IS THE PURCHASER'S SOLE AND EXCLUSIVE REMEDY AND IS IN LIEU OF ALL OTHER WARRANTIES, EXPRESS OR IMPLIED. NOKIA SHALL NOT BE LIABLE FOR INCIDENTAL OR CONSEQUENTIAL DAMAGES OR A LOSS OF ANTICIPATED BENEFITS OR PROFITS, LOSS OR IMPAIRMENT OF PRIVACY OF CONVERSATIONS, WORK

**STOPPAGE OR LOSS OR IMPAIRMENT OF DATA ARISING OUT OF THE USE OR INABILITY TO USE THE PRODUCT.**

12. The benefits conferred by this limited warranty are in addition to all other rights and remedies under any applicable mandatory legislation as may be in force from country (area) to country (area).
13. Nokia neither assumes nor authorizes any authorized service center or any person or entity to assume for it any other obligation or liability beyond that which is expressly provided for in this limited warranty.
14. All warranty information, product features and specifications are subject to change without notice.
15. The countries (or areas) in which this limited warranty is in force, subject to clause 4 above, are Hong Kong SAR and Macau SAR.

# Index

## A

- access code 8
- active standby 14, 27
- anykey answer 30
- applications 42
- audio messages 22
- automatic redial 30

## B

- barring password 8
- battery 50
  - charging 11
- battery charge status 13
- browser 45
  - security 46
- business cards 25

## C

- cache memory 46
- calculator 44
- call divert 30
- call log 26
- call waiting 30
- caller id 30
- calling 16
- calls 16
  - options 17
- camera 37
- certificates 47
- charge the battery 11
- configuration 31
- configuration setting service 8

- contact information 8
- contacts 24
  - memory 24
- cookies 46
- customer service 8

## D

- data cable 30
- dialing 16
- dialing shortcuts 16, 25
- digital signature 47
- display 13, 27
- downloads 8

## E

- e-mail 21
- enhancements 31
- equalizer 40

## F

- files 35
- flash messages 22
- flight mode 15
- flight query 31
- FM radio 39
- folders 35
- font size 27

## G

- gallery 35
- games 42
- Genuine enhancements 49

## H

- handsfree
  - See *loudspeaker*
- headphones 12
- headset 12
- help text 31

## I

- idle mode 13
- IM 23
- indicators 14
- info messages 23
- installation 10
- instant messaging 23
- internet 45

## K

- keyguard 15, 31
- keypad lock 15
- keys 12

## L

- language 30
- loudspeaker 17

## M

- memory card 35
  - insert 10
- message centre number 20
- message sending 21

messages  
  settings 23  
messaging  
  audio messages 22  
microSD card  
  insert 10  
music player 37

## N

navigation 19  
Nokia contact information 8  
notes 44  
number mode 18

## O

offline mode 15  
operator menu 34  
organiser 43

## P

parts 12  
PC Suite 30  
phonebook  
  *See contacts*  
PictBridge 30  
picture 37  
PIN 8  
power saver 27  
power saving 14  
predictive text input 18  
print images 35  
profiles 27  
PTT

*See push to talk*

PUK 8  
push to talk 41

## R

radio 39  
recorder 40  
redial 30

## S

screen saver 27  
scrolling 19  
security code 8  
security module 8  
service commands 23  
service inbox 46  
settings 27  
  active standby 27  
  call 30  
  configuration 31  
  date 28  
  display 27  
  factory 33  
  font size 27  
  messages 23  
  phone 30  
  power saver 27  
  profiles 27  
  screen saver 27  
  security 32  
  shortcuts 28  
  sleep mode 27  
  streaming 38  
  themes 27  
  time 28

tones 27  
wallpaper 27  
shortcuts 14, 28  
signal strength 13  
SIM  
  services 48  
SIM card 15  
  installation 10  
SIM messages 23  
sleep mode 27  
speed dialing 16, 25  
speed dialling 30  
standby mode 13  
start up tone 31  
status indicators 13  
stopwatch 44  
strap 12

## T

take a picture 37  
text modes 18  
themes 27  
timer 44  
to-do list 43  
tones 27  
traditional text input 18

## U

UPIN 8  
USB data cable 30

## V

video clips 37  
visual radio 39

**voice clarity 30**  
**voice commands 31**  
**voice dialing 16**  
**voice messages 23**  
**voice recognition 31**  
**voice recorder 40**

## **W**

**wallpaper 27**  
**web 45**  
**welcome note 31**  
**WML scripts 46**  
**write text 18**