

A woman with short reddish hair and a man smiling on a city street at night. The woman is wearing a black jacket over a teal top and a pink scarf. The man is wearing a dark suit jacket over a striped shirt. In the background, there are city lights and a woman walking away.

Get started



NOKIA
Nseries

Nokia N95-4
9207276, Issue 1 EN

Keys and parts (front)

Model number: Nokia N95-4.

Hereinafter referred to as Nokia N95 8GB.

- 1 Power key
- 2 Selection keys to select commands and access Options
- 3 Menu key  to access the main menu
- 4 Call key
- 5 Edit key  to open a list of commands when you edit text
- 6 Scroll key to move around the menus and to select items
- 7 Numeric keypad
- 8 Clear key
- 9 End key
- 10 Multimedia key to access the multimedia menu and open the music player
- 11 Light sensor
- 12 Secondary camera with lower resolution

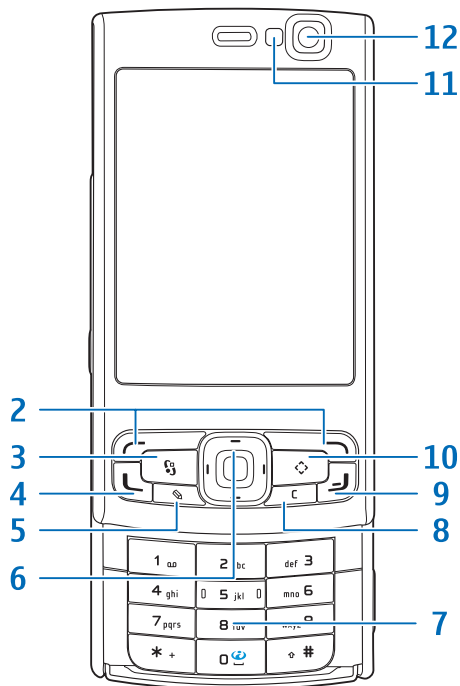
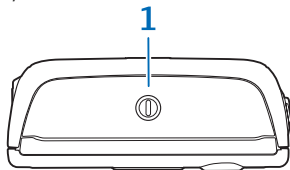

Keys and parts (landscape)

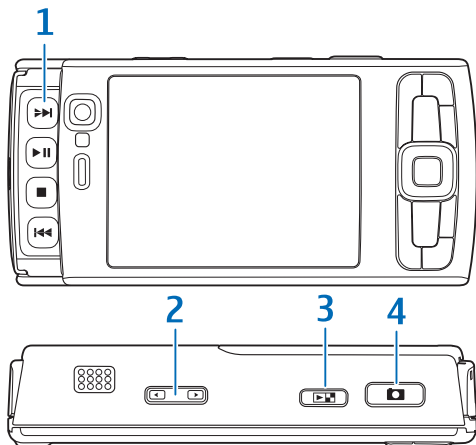

1 Media keys under the 2-way slide

- Next key ►►
- Play/pause key ►►||
- Stop key ■
- Previous key ◀◀

2 Zoom/volume key

3 Review key  to view the last stored image or video clip

4 2-stage capture key  for auto-focus, still image capture, and video recording

When you open the media keys under the 2-way slide, the media mode is activated and the display is shown in landscape orientation.

Use the media keys to control music and video players.

To activate the main camera, press and hold the capture key. To lock the focus on an object, press the capture key halfway down. To take a picture, press the capture key down.

To activate the video mode, select  in the active toolbar. To shoot video, press the capture key down.

Keys and parts (back)

- 1 Charger connector
- 2 Mini-USB connector to connect to a compatible PC
- 3 Stereo speakers with 3D sound effect
- 4 Main camera for high resolution image capture and video recording (up to 5 megapixel)
- 5 Camera flash
- 6 Nokia AV Connector (3.5 mm) for compatible headsets, headphones, and TV-out cables, for example, the Nokia Video Connectivity Cable
- 7 Infrared (IR) window

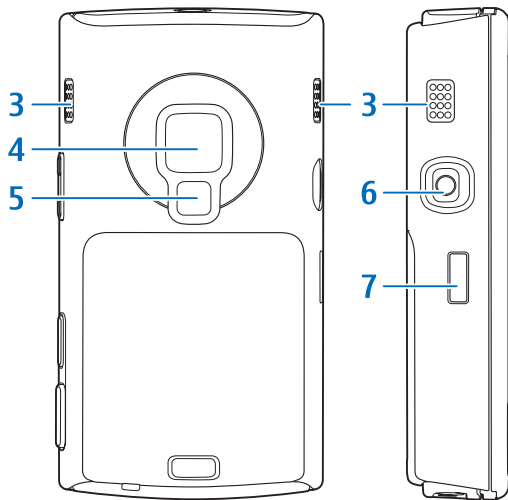
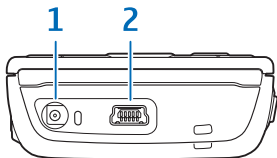

Insert the (U)SIM card and battery

A USIM card is an enhanced version of the SIM card and is supported by UMTS mobile phones.

Always switch the device off and disconnect the charger before removing the battery.

For availability and information on using SIM card services, contact your SIM card vendor. This may be the service provider or other vendor.

- 1 With the back of the device facing you, press and hold the release button, slide the cover, and lift it up.

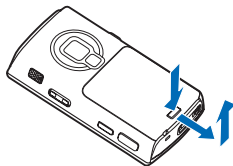

- 2 To release the (U)SIM card holder, lift the holder up from the handle.

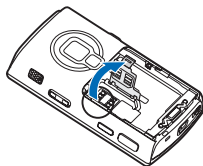

- 3 Insert the (U)SIM card. Make sure that the contact area on the card is facing the connectors on the device and the bevelled corner on the card is facing the base of the device.

- 4 Close the holder, and lock it into place.

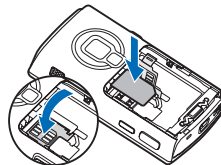

- 5 Insert the battery. To secure the battery into place, press it gently.

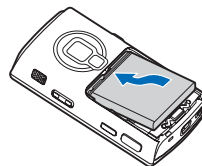

- 6 Replace the cover so that the locking catches are directed towards their slots, and slide the cover into place.

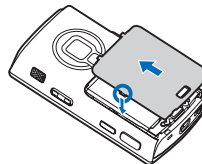

Switch the device on

- 1 Press and hold the power key.
- 2 If the device asks for a (U)PIN code or lock code, enter it, and press the left selection key. The factory setting for the lock code is **12345**.

Your device has internal antennas.



Note: As with any radio transmitting device, avoid touching an antenna unnecessarily when the antenna is in use. For example, avoid touching the cellular antenna during a phone call. Contact with a transmitting or receiving antenna affects the quality of the radio communication, may cause the device to operate at a higher power level than otherwise needed, and may reduce the battery life.

- 1 Cellular antenna
- 2 Bluetooth technology/wireless LAN antenna
- 3 GPS receiver

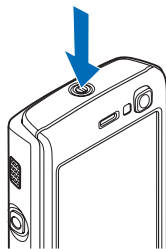
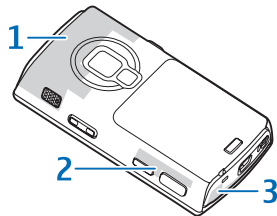

Charge the battery

- 1 Connect a compatible charger to a wall outlet.
- 2 Connect the power cord to the device. If the battery is completely discharged, it may take a while before the charging indicator starts scrolling.
- 3 When the battery is fully charged, the charging indicator stops scrolling. Disconnect the charger from the device, then from the wall outlet.

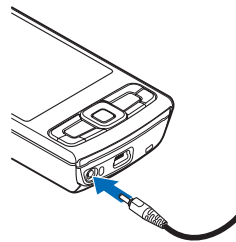

Tip: Disconnect the charger from the wall outlet when the charger is not in use. A charger that is connected to the outlet consumes power even when it is not connected to the device.

Transfer content

Transfer personal content from another Nokia device

With the Switch application, you can transfer content, such as contacts, between two compatible Nokia devices using Bluetooth connectivity or infrared. To transfer data to your Nokia N95 8GB, press , and select Tools > Utilities > Switch.

Transfer content from PC

You can use your device with a variety of compatible PC connectivity and data communications applications. You can, for example, transfer music, images, and videos between your device and a compatible PC by using a compatible USB data cable, Bluetooth connectivity, or Nokia Nseries PC Suite installed on your compatible PC. Always create the connection from the PC to synchronise with your device.

Support

Help

The help function provides instructions when using the applications in the device. To access it from an application, select Options > Help.

User guide

Refer to the user guide for other important information about your device.

Online

Check www.nseries.com/support or your local Nokia website for the latest guides, additional information, downloads, and services related to your Nokia product.



Tip: You can also access the support pages from the web browser in your device.

Keypad lock (keyguard)

When the keys are locked,  is displayed.

To lock the keys, press the left selection key, then the right selection key.



To unlock the keys, open the 2-way slide, or press the left selection key, then the right selection key.

To have the keypad lock activated automatically after a time-out or when the 2-way slide is closed, press , and select **Tools > Settings > General > Security > Phone and SIM card**.

 **Tip:** If you want to close the 2-way slide without activating the keypad lock, press any key after you close the slide.

When the keypad lock is on, calls may be possible to the official emergency number programmed into your device.

Shortcuts

- To switch between open applications, press and hold .
- To open Music player, press and hold the multimedia key.
- In many applications, to view the most used option items, press the scroll key.
- To open Gallery, press  once.

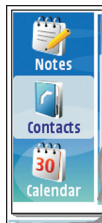

- To call your voice mailbox (network service), press and hold **1**.
- To open the multimedia menu, press the multimedia key.
- To change the profile, press the power key, and select a profile.
- To switch between **Normal** and **Silent** profiles, press and hold **#**. If you have two phone lines (network service), this action switches between the two lines.
- To open the last dialed numbers list, press the call key.
- To use voice commands, press and hold the right selection key.
- To start the Web browser (network service), press and hold **0**.

Personalization

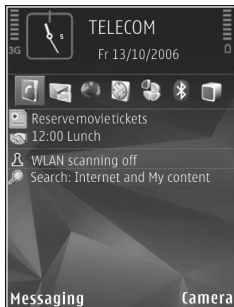

In the personalization menu, you can change several settings in your device. Press , and select Tools > Settings > General > Personalization and from the following:

- Themes – to change the theme, wallpaper and power saver settings
- Display > Light time-out – to adjust the backlight timeout
- Display > Font size – to adjust the size of the text and icons on the display
- Standby mode > Active standby – to switch the active standby on or off. The active standby display shows application shortcuts and events from applications.



- Standby mode > Shortcuts – to assign a shortcut to the selection keys in the standby mode
- Standby mode > Active standby apps. – to change the default shortcut icons in the active standby mode. Some shortcuts may be fixed, and you cannot change them.

There are also other items you can modify:

- To modify a profile, press , and select Tools > Profiles > Options > Customize. You can, for example, customise the ringing tones and message alert tones.
- To change the clock shown in the standby mode, press , and select Applications > Clock > Options > Settings > Clock type.

Nokia Video Center

With Nokia Video Center (network service), you can download and stream video clips over the air from compatible internet video services.

Nokia Video Center supports files with extensions such as .3gp, .mp4, or .rm.

To connect to the internet to browse available services that you can add to Nokia Video Center, select **Add new services**.

To find and view videos, do the following:

- 1 Press **F5**, and select **Video center**.
- 2 To connect to a service, select the desired video service.
- 3 Some video clips can be streamed over the air, but others must be first downloaded to your device. To download a video clip, select **Options > Download**.

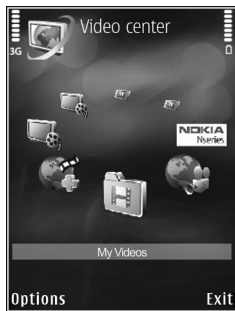

The downloaded videos are saved in **Video center > My Videos**.

You can also transfer your own videos to Nokia Video Center and view them in **My Videos**.

Tip: To convert video files into mobile format, use Nokia Video Manager in Nokia Nseries PC Suite.

- 1 To view your device on your compatible PC as a mass memory device, make the connection with a compatible USB cable.
- 2 Select **Data transfer** as the connection mode.
- 3 Select the videos you want to copy from your PC.
- 4 Transfer the videos to **E:\My Videos** in the mass memory of your device.

Video files in other folders of your device are not displayed in **My Videos**.

Music player



Warning: Listen to music at a moderate level. Continuous exposure to high volume may damage your hearing. Do not hold the device near your ear when the loudspeaker is in use, because the volume may be extremely loud.

Music player supports file formats such as AAC, AAC+, eAAC+, MP3, and WMA. Music player does not necessarily support all features of a file format or all the variations of file formats.

Use the media keys under the 2-way slide to control Music player.

To play a song, do the following:

- 1 Press and hold the multimedia key.
- 2 Select categories to navigate to the songs you want to hear.
- 3 To play the selected files, press ►||.

To select more music to play in the Now playing view, select **Options > Go to Music menu**.

To view and manage playlists, in **Music player**, select **Music > Playlists**.

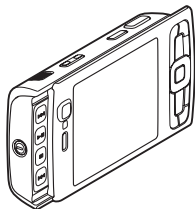

You can transfer music from a compatible PC or other compatible devices using a compatible USB data cable, a compatible version of Microsoft's Windows Media Player installed on your compatible PC, or Nokia Music Manager available in Nokia Nseries PC Suite.

Copyright protections may prevent some images, music (including ringing tones) and other content from being copied, modified, transferred, or forwarded.

Windows Media Player 10 may cause playback delays to WMDRM technology protected files after they have been transferred to your device. Check Microsoft support website for a hotfix to Windows Media Player 10, or get a newer compatible version of Windows Media Player.

Headset



Warning: When you use the headset, your ability to hear outside sounds may be affected. Do not use the headset where it can endanger your safety.

Some headsets come in two parts, a remote control unit and headphones. A remote control unit, for example, the Nokia Audio Controller AD-54, has a microphone and keys to answer or end a phone call, adjust the volume, and play music or video files. To use the headphones with a remote control unit, connect the unit to the Nokia AV Connector (3.5 mm) in the device, then connect the headphones to the unit.

If a headset does not include a microphone, for handsfree phone calls, use such a headset with a compatible remote control unit or the microphone of the device.

When using certain headset enhancements, to adjust the volume during a call, use the volume key in the device. Some headset enhancements have multimedia volume controls that are used to adjust the volume only for music or video playback.

You can also connect another compatible headset, compatible headphones, or a compatible TV-out cable to the Nokia AV Connector (3.5 mm) of your device. You may need to select the cable mode.

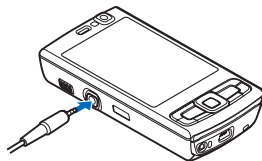

Do not connect products that create an output signal as this may cause damage to the device. Do not connect any voltage source to the Nokia AV Connector.

When connecting any external device or headset to the Nokia AV Connector (other than those approved by Nokia for this use), pay attention to volume levels.

Positioning (GPS)

The Global Positioning System (GPS) is a worldwide radio navigation system that includes 24 satellites and their ground stations that monitor the operation of the satellites. Your device has an internal GPS receiver.

The GPS receiver is located in the bottom of the device. When using the receiver, slide the numeric keypad open, and from an upright position, move the device to an angle of about 45 degrees with an unobstructed view of the sky. Do not cover the numeric keypad with your hand.



The accuracy of location data can be affected by poor satellite geometry. Availability and quality of GPS signals may be affected by your location, buildings, natural obstacles, and weather conditions. The GPS receiver should only be used outdoors to allow reception of GPS signals.

Your device also supports Assisted GPS (A-GPS) (network service).

Assisted GPS (A-GPS) is used to retrieve assistance data over a packet data connection, which assists in calculating the coordinates of your current location when your device is receiving signals from satellites.

Any GPS should not be used for precise location measurement, and you should never rely solely on location data from the GPS receiver and cellular radio networks for positioning or navigation.

Maps

With Maps, you can see your current location on the map, browse maps for different cities and countries, search for addresses, and plan routes. To open the Maps application, press , and select **Maps**. The map coverage varies by country.

Almost all digital cartography is inaccurate and incomplete to some extent. Never rely solely on the cartography that you download for use in this device.

When you browse the map on the display, for example, to move to another country, a new map is downloaded automatically, provided that you have an internet connection. Downloading maps may involve the transmission of large amounts of data through your service provider's network. Contact your service provider for information about data transmission charges.

Download maps

Nokia Map Loader is a PC software that you can use to download and install maps for different countries to your device from the internet. To use Nokia Map Loader, you must first install it to a compatible PC. You can download the software from the internet at www.nokia.com/maps. Follow the instructions on the screen.

You can also download maps by using a wireless LAN connection. You can view the amount of transferred data from the data counter (KB) shown on the display. The counter shows the amount of network traffic when you browse maps, create routes, or search for locations online.

To check whether the maps that are downloaded to your device have been updated on the map server, select **Options > Settings > Network > Options > Check for map updates**.

To prevent the device from automatically downloading maps through the internet, for example, when you are outside your home cellular network, select **Options > Settings > Network > Use network > Off**.

Wireless LAN wizard

Your device supports wireless local area network (WLAN). With WLAN, you can connect your device to the internet and compatible devices that have WLAN. To use WLAN, it must be available in the location, and your device must be connected to the WLAN.

The WLAN wizard helps you to connect to a WLAN and manage your WLAN connections. The WLAN wizard shows the status of your WLAN connections in the active standby mode. To view the available options, scroll to the row showing the status, and select it.

If WLAN scanning is off and you are not connected to any WLAN, **WLAN scanning off** is displayed. To set scanning on and search for available WLANs, select the status, and press the scroll key.



Important: Always enable one of the available encryption methods to increase the security of your wireless LAN connection. Using encryption reduces the risk of unauthorized access to your data.

© 2007 Nokia. All rights reserved.

Nokia, Nokia Connecting People, Nseries, and N95 are trademarks or registered trademarks of Nokia Corporation. Other product and company names mentioned herein may be trademarks or tradenames of their respective owners.

Reproduction, transfer, distribution, or storage of part or all of the contents in this document in any form without the prior written permission of Nokia is prohibited.

Notes