

CARATTERISTICHE GENERALI GENERAL CHARACTERISTICS CARACTÉRISTIQUES GÉNÉRALES

Certificazioni

*RACCORDI PER LIQUIDI ALIMENTARI**

I Raccordi in Poliammide sono compatibili al contatto con i liquidi alimentari secondo la Direttiva Europea 2002/72/CE.

I Raccordi in Polipropilene sono compatibili al contatto con i liquidi alimentari secondo la Direttiva Europea 2002/72/CE e successivi aggiornamenti - classi A,B,C, esclusi alimenti grassi.

Tutti i nostri prodotti sono esenti da ftalati e plastificanti.

*Contattare i nostri uffici per maggiori informazioni

Materiali

Certifications

*FITTINGS FOR FOOD LIQUIDS**

The fittings in polyamidic resin are suitable for contact with food liquids according to EU Directive 2002/72/EC.

The fittings in polypropylene are suitable for contact with food liquids according to EU Directive 2002/72/EC and following changes - classes A, B, C, excepting fatty foods.

All our products are clear of phthalates and plasticizing materials.

*For further information please get in touch with our offices.

Materials

Certifications

*RACCORDS POUR LIQUIDES ALIMENTAIRES**

Les raccords en polyamide sont compatibles au contact avec les liquides alimentaires selon la Directive Européenne 2002/72/CE.

Les raccords en polypropylène sont compatibles au contact avec les liquides alimentaires selon la Directive Européenne 2002/72/CE et modifications ultérieures - classes A, B, C, sauf aliments gras.

Tous nos produits sont libres de phtalates et plastifiants.

*Contacter nos bureaux pour plus d'informations

Matériaux

Linea - Line - Ligne		
2000		
<p>raccordi filettati: Poliammide (nylon 66) PA raccordi porta gomma: Poliammide (nylon 66) PA</p> <ul style="list-style-type: none"> – estremità con filettatura interna ghiera mobile: guarnizione piana in EPDM – estremità con filettatura esterna con sede O-ring: O-ring in NBR 	<p>threaded fittings: Polyamide (nylon 66) PA hose couplings: Polyamide (nylon 66) PA</p> <ul style="list-style-type: none"> – end with internal thread mobile ring nut: EPDM flat gasket – end with external thread with place to fit O-ring: NBR O-ring 	<p>raccords filetés : Polyamide (nylon 66) PA embouts cannelés : Polyamide (nylon 66) PA</p> <ul style="list-style-type: none"> – extrémité avec filet intérieur écrou mobile : joint plat en EPDM – extrémité avec filet extérieur avec siège joint torique : joint torique en NBR
8000		
<p>raccordi filettati: Polipropilene copolimero PPH - PPC - FV</p> <ul style="list-style-type: none"> – bocchettone: guarnizione O-ring in EPDM – attacchi per serbatoi: guarnizione piana in EPDM <p>raccordi porta gomma: Polipropilene copolimero PPH - PPC - FV</p> <ul style="list-style-type: none"> – estremità con filettatura interna ghiera mobile: guarnizione piana in EPDM – estremità con filettatura esterna con sede O-ring: O-ring in NBR 	<p>threaded fittings: Polypropylene copolymer PPH - PPC - FV</p> <ul style="list-style-type: none"> – union: EPDM O-ring gasket – tank adaptors: EPDM flat gasket <p>hose couplings: Polypropylene copolymer PPH - PPC - FV</p> <ul style="list-style-type: none"> – end with internal thread mobile ring nut: EPDM flat gasket – end with external thread with place to fit O-ring: NBR O-ring 	<p>raccords filetés : polypropylène copolymère PPH - PPC - FV</p> <ul style="list-style-type: none"> – raccord union : joint torique en EPDM – raccords pour réservoirs : joint plat en EPDM <p>embouts cannelés : polypropylène copolymère PPH - PPC - FV</p> <ul style="list-style-type: none"> – extrémité avec filet intérieur écrou mobile : joint plat en EPDM – extrémité avec filet extérieur avec siège joint torique : joint torique en NBR
4000		
<p>raccordi filettati: Polipropilene PPH – PPC - FV</p> <ul style="list-style-type: none"> – bocchettone: O-ring in NBR – attacchi per serbatoi: guarnizione piana in EPDM <p>raccordi porta gomma: Polipropilene PPH – PPC - FV</p> <ul style="list-style-type: none"> – estremità con filettatura interna ghiera mobile e fissa: guarnizione piana in EPDM – estremità con filettatura esterna con sede O-ring: O-ring in NBR – estremità con attacco passaparete: guarnizione piana in EPDM – estremità con battuta ampia per attacco passa parete: guarnizione piana in EPDM <p>raccordi porta gomma gradinati: Poliestere PS</p> <ul style="list-style-type: none"> – estremità con filettatura interna ghiera mobile e fissa: guarnizione piana in EPDM – estremità con filettatura esterna con sede O-ring: O-ring in NBR 	<p>threaded fittings: Polypropylene PPH - PPC - FV</p> <ul style="list-style-type: none"> – union: NBR O-ring – tank adaptors: EPDM flat gasket <p>hose couplings: Polypropylene PPH - PPC - FV</p> <ul style="list-style-type: none"> – end with internal thread mobile and fixed ring nut: EPDM flat gasket – end with external thread with place to fit O-ring: NBR O-ring – end with passwall connector: EPDM flat gasket – end with large stop for passwall connector: EPDM flat gasket <p>stepped hose couplings: Polyester PS</p> <ul style="list-style-type: none"> – end with internal thread mobile and fixed ring nut: EPDM flat gasket – end with external thread with place to fit O-ring: NBR O-ring 	<p>raccords filetés : polypropylène PPH – PPC - FV</p> <ul style="list-style-type: none"> – raccord union : joint torique en NBR – raccords pour réservoirs : joint plat en EPDM <p>embouts cannelés : polypropylène PPH – PPC - FV</p> <ul style="list-style-type: none"> – extrémité avec filet intérieur écrou mobile et fixe : joint plat en EPDM – extrémité avec filet extérieur avec siège joint torique : joint torique en NBR – extrémité avec raccord passe-paroi : joint plat en EPDM – extrémité avec grande butée pour raccord passe-paroi : joint plat en EPDM <p>embouts cannelés en gradins : polyester PS</p> <ul style="list-style-type: none"> – extrémité avec filet intérieur écrou mobile et fixe : joint plat en EPDM – extrémité avec filet extérieur avec siège joint torique : joint torique en NBR

7000		
raccordi filettati, per saldatura nel bicchiere: Polipropilene omopolimero PPH – bocchettone: guarnizione O-ring in FPM raccordi porta gomma: Polipropilene omopolimero PPH – estremità con filettatura interna ghiera mobile: guarnizione piana in EPDM	threaded fittings for socket fusion welding: Polypropylene homopolymer PPH – union: FPM O-ring gasket hose couplings: Polypropylene homopolymer PPH – end with internal thread mobile ring nut: EPDM flat gasket	raccords filetés, pour soudure dans l'embout: polypropylène homopolymère PPH – raccord union: joint torique en FPM embouts cannelés: polypropylène homopolymère PPH – extrémité avec filet intérieur écrou mobile: joint plat en EPDM
3000		
raccordi filettati: Polipropilene rinforzato con fibre di vetro PPH FV – attacchi per serbatoi: guarnizione piana in EPDM raccordi porta gomma: Poliammide (nylon 66) PA e Polipropilene PP valvole a sfera: – estremità con attacco passaparete: guarnizione piana in EPDM	threaded fittings: Fiberglass reinforced polypropylene PPH FV – tank adaptors: EPDM flat gasket hose couplings: Polyamide (nylon 66) PA and Polypropylene PP ball valves: – end with passwall connector: EPDM flat gasket	raccords filetés: polypropylène renforcé avec fibre de verre PPH FV – raccords pour réservoirs: joint plat en EPDM embouts cannelés: polyamide (nylon 66) PA et polypropylène PP vannes à bille: – extrémité avec raccord passe-paroi: joint plat en EPDM

Colore

Colour

Couleur

Linea Line Ligne			
2000	raccordi filettati e portagomma: naturale	threaded fittings and hose couplings: Natural	raccords filetés et cannelés: naturel
8000	raccordi filettati e portagomma: grigio: simile a RAL 7015 Ghiera bocchettone: grigio RAL 7032	threaded fittings and hose couplings: Grey: Similar to RAL 7015 Union ring nut: grey RAL 7032	raccords filetés et cannelés: gris: similaire au RAL 7015 Écrou raccord union: gris RAL 7032
4000	raccordi filettati e portagomma: nero simile a RAL 9011 Ghiera bocchettone: grigio RAL 7032	threaded fittings and hose couplings: black, similar to RAL 9011 Union ring nut: grey RAL 7032	raccords filetés et cannelés: noir similaire au RAL 9011 Écrou raccord union: gris RAL 7032
7000	raccordi filettati, per saldatura nel bicchiere e porta gomma Grigio RAL 7032	threaded fittings for socket fusion welding and hose couplings Grey RAL 7032	raccords filetés, pour soudure dans l'embout et cannelés Gris RAL 7032
3000	raccordi in PP: bianco RAL 9003 raccordi in PA: naturale valvole a sfera: corpo: bianco RAL 9003 maniglia: rosso RAL 3031	PP fittings: white RAL 9003 PA fittings: natural ball valves: body: white RAL 9003 handle: red RAL 3031	raccords en PP: blanc RAL 9003 raccords en PA: naturel vannes à bille: corps: blanc RAL 9003 manette: rouge RAL 3031

Legenda raccordi e valvole

Key to acronyms for fittings and valves Légende raccords et vannes

Linea / Line / Ligne 2000 - 8000 - 4000 - 7000 - 3000			
d	diametro nominale esterno del tubo in mm	<i>pipe nominal outside diameter in mm</i>	diamètre nominal extérieur du tuyau en mm
DN	diametro nominale interno in mm	<i>nominal inside diameter in mm</i>	diamètre nominal intérieur en mm
G	dimensione nominale del filetto femmina in pollici	<i>nominal size of female thread in inches</i>	dimension nominale du filet femelle en pouces
G1	dimensione nominale del filetto maschio in pollici	<i>nominal size of male thread in inches</i>	dimension nominale du filet mâle en pouces
M	profilo metrico	<i>metric pitch</i>	profil métrique
PN	pressione nominale in bar a 20°	<i>nominal pressure in bar at 20°</i>	pression nominale en bar à 20°
g	peso in grammi	<i>weight in grams</i>	poids en grammes
K	chiave	<i>key</i>	clef
PA	poliammide 66	<i>polyamide 66</i>	polyamide 66
POM	resina acetilica	<i>acetal resin</i>	résine acétalique
PPH	polipropilene omopolimero	<i>polypropylene homopolymer</i>	polypropylène homopolymère
PPC	polipropilene copolimero	<i>polypropylene copolymer</i>	polypropylène copolymère
PPH FV	polipropilene rinforzato con fibre di vetro	<i>fiberglass reinforced polypropylene</i>	polypropylène renforcé avec fibre de verre
PS	poliestere	<i>polyester</i>	polyester
EPDM	elastomero etilene propilene	<i>ethylene propylene elastomer</i>	caoutchouc éthylène-propylène
NBR	elastomero acrilico-nitrile butadiene	<i>acrylo-nitril-butadiene elastomer</i>	caoutchouc acrylo-nitrile butadiène
PTFE	politetra fluoro etilene	<i>polytetra fluore ethylene</i>	polytétrafluoroéthylène
FPM	fluoroelastomero	<i>fluoroelastomer</i>	fluoroélastomère

PRESTAZIONI

Raccordi	Modello	Linea				
		2000	8000	4000	7000	3000
Pressione di esercizio:						
16 bar a 20 °C	filettati e portagomma	X				
10 bar a 20 °C	filettati		X	X	X	
10 bar a 20 °C	per saldatura				X	
10 bar a 20 °C	portagomma				X	
6 bar a 20 °C	portagomma		X	X		
Temperatura max di esercizio						
80 °C	tutti		X	X		X
90 °C	tutti	X				
100 °C	tutti				X	
Ottima resistenza alle basse temperature	tutti		X	X		
Temperatura minima 0 °C	tutti				X	
Eccellente resistenza meccanica ed all'urto con elevati fattori di sicurezza	tutti	X	X	X		
Buona resistenza meccanica ed all'urto con elevati fattori di sicurezza	porta gomma gradinati			X		
Ottima resistenza alla trazione, compressione, e flessione	tutti	X				
Buona resistenza alla trazione, compressione, e flessione	filettati		X	X		
Ottima stabilità termica: soprattutto nel campo di temperatura intermedia fra 10 °C e 80 °C il PPH trova il suo tipico impiego, garantendo prestazioni di eccellente resistenza meccanica ed all'urto con elevati fattori di sicurezza	tutti				X	
Durata nel tempo grazie alla struttura del polipropilene e poliammide che resistono alle sollecitazioni termiche e meccaniche, agli agenti atmosferici ed ai raggi UV	tutti	X	X	X	X	X
Buona resistenza alla abrasione (secondo norma DIN 53516)	tutti	X				
Buona resistenza chimica: resiste al contatto con soluzioni acquose di sali inorganici, acidi deboli inorganici e soluzioni alcaline, alcool o alcuni oli. Inoltre mantiene elevate caratteristiche meccaniche anche nel trasporto di detergenti e prodotti chimici similari	tutti		X	X	X	
Isolante elettrico: materiali elettricamente isolanti resi immuni da fenomeni di corrosione elettrochimica e da perforazioni causate dalle correnti vaganti	tutti	X	X	X	X	X
Assoluta atossicità: le resine PPH - PPC - FV - PA offrono completa compatibilità anche nel trasporto di fluidi alimentari, di acqua potabile e da potabilizzare, di acque demineralizzate secondo le vigenti norme nazionali ed internazionali	tutti	X	X	X	X	X

Per ulteriori informazioni consultare la "guida alla resistenza chimica".

PERFORMANCE

Fittings	Model	Line				
		2000	8000	4000	7000	3000
Working pressure:						
16 bar at 20 °C	threaded and hose	X				
10 bar at 20 °C	threaded		X	X	X	
10 bar at 20 °C	for welding				X	
10 bar at 20 °C	hose				X	
6 bar at 20 °C	hose		X	X		
Max. working temperature:						
80 °C	all		X	X		X
90 °C	all	X				
100 °C	all				X	
Very good resistance to low temperatures	all		X	X		
Minimum temperature 0°C	all				X	
Excellent mechanical and impact strength, high safety factors	all	X	X	X		
Good mechanical and impact strength, high safety factors	stepped hose couplings			X		
Very good tensile, compression and bending strength	all	X				
Good tensile, compression and bending strength	threaded		X	X		

Fittings	Model	Line				
		2000	8000	4000	7000	3000
Very good shape permanence to heat: PPH performs best mainly within an intermediate temperature range - 10 °C to 80 °C - guaranteeing excellent mechanical and impact strength, plus high safety factors	all				X	
Long life, due to the structure of polypropylene and polyamide which endures thermal and mechanical stress, weather conditions, and UV rays	all	X	X	X	X	X
Good abrasion resistance (DIN 53516)	all	X				
Good resistance to chemicals: resistant to contact with inorganic salts in aqueous solutions, weak inorganic acids and alkaline solutions, alcohol and some oils. Very good mechanical characteristics also when carrying detergents and similar chemicals	all		X	X	X	
Electric insulator: electrically insulating material protected against electro-chemical corrosion and perforations caused by stray currents	all	X	X	X	X	X
100% not toxic: PPH - PPC - FV - PA resins are fully compatible to carry liquid foods, drinking water, water to be made potable, de-mineralised water in compliance with the national and international legislation in force.	all	X	X	X	X	X

For further information, consult the "Guide to chemical resistance".

PERFORMANCE

Raccords	Modèle	Ligne				
		2000	8000	4000	7000	3000
Pression de service :		2000	8000	4000	7000	3000
16 bar à 20 °C	filetés et embouts cannelés	X				
10 bar à 20 °C	filetés		X	X	X	
10 bar à 20 °C	pour soudure				X	
10 bar à 20 °C	embout cannelé				X	
6 bar à 20 °C	embout cannelé		X	X		
Température maximum de service						
80 °C	tous		X	X		X
90 °C	tous	X				
100 °C	tous				X	
Résistance excellente aux basses températures	tous		X	X		
Température minimum 0 °C	tous				X	
Excellente résistance mécanique et aux chocs avec des facteurs de sécurité élevés	tous	X	X	X		
Bonne résistance mécanique et aux chocs avec des facteurs de sécurité élevés	embouts cannelés en gradins			X		
Résistance excellente à la traction, compression et flexion	tous	X				
Bonne résistance à la traction, compression et flexion	filetés		X	X		
Stabilité thermique excellente : surtout à une température intermédiaire entre 10 °C et 80 °C, le PPH trouve son emploi typique, garantissant une excellente résistance mécanique et au choc avec des facteurs de sécurité élevés	tous				X	
Durée dans le temps grâce à la structure du polypropylène et du polyamide, qui résiste aux sollicitations thermiques et mécaniques, aux agents atmosphériques et aux rayons UV	tous	X	X	X	X	X
Bonne résistance à l'abrasion (selon la norme DIN 53516)	tous	X				
Bonne résistance chimique : résiste au contact avec des solutions aqueuses de sels inorganiques, acides faibles inorganiques et solutions alcalines, alcool ou des huiles. En outre, maintient des propriétés mécaniques élevées aussi dans le transport des détergents et de produits chimiques similaires.	tous		X	X	X	
Isolant électrique : matériaux isolants électriquement, rendus immuns à la corrosion électrochimique et à la perforation causée par les courants vagabonds	tous	X	X	X	X	X
Complète atoxicité : les résines PPH - PPC - FV - PA sont totalement compatibles aussi dans le transport de liquides alimentaires, eau potable et à potabiliser, eau déminéralisée selon les normes nationales et internationales.	tous	X	X	X	X	X

Pour d'autres informations, consulter la «guide à la résistance chimique».

CONDIZIONI MASSIME DI ESERCIZIO

Diagramma della variazione della pressione in funzione della temperatura per acqua o fluidi nei confronti dei quali PP sono classificati chimicamente idonei

PP-PN 10

Temperatura Max Max Temperature Température max	Durata Anni Working life Durée	Pressioni di esercizio massime Operating pressure maximum Pression de service maximum
20 °C	10 50	12 bar 10 bar
40 °C	10 50	8 bar 6 bar
60 °C	10 50	5 bar 3 bar
80 °C 100 °C	10 50	2,5 bar 1 bar

PP-PN 6

Temperatura Max Max Temperature Température max	Durata Anni Working life Durée	Pressioni di esercizio massime Operating pressure maximum Pression de service maximum
20 °C	10 50	7,2 bar 6 bar
40 °C	10 50	5 bar 3,6 bar
60 °C	10 50	3 bar 1,8 bar
80 °C 100 °C	10 50	1,5 bar 0,6 bar

Vantaggi

I VANTAGGI DEI RACCORDI

Poliamide PA 66 rispetto all'ottone:

sono **più leggeri** pur mantenendo ottime caratteristiche, meccaniche, termiche e **superiori** alla:

- resistenza alla corrosione
- resistenza agli agenti atmosferici
- assoluta atossicità

Polipropilene PP rispetto a quelli in PVC è nelle prestazioni:

- range più ampio di temperatura di esercizio
- resistenza meccanica superiore
- resistenza alla flessione superiore

MAXIMUM OPERATING CONDITIONS

Diagram illustrating the operating pressure change in response to water or fluid temperature for which PP has been classified chemically resistant.

CONDITIONS MAXIMUM DE SERVICE

Diagramme de la variation de pression en fonction de la température pour eau ou fluides pour lesquels le PP est classifié chimiquement résistant.

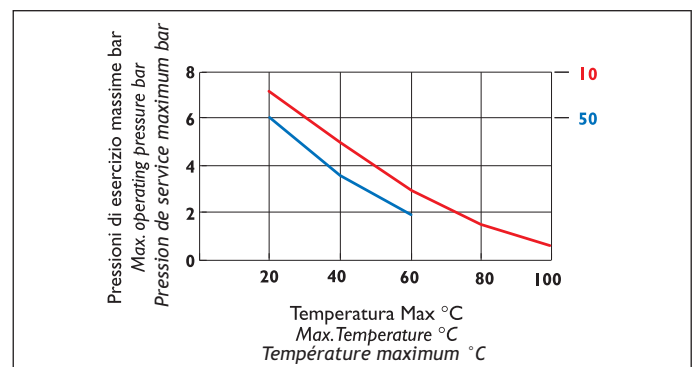
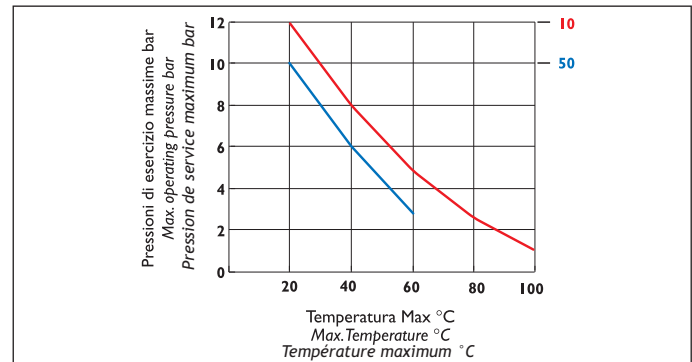

Advantages

ADVANTAGES OF FITTINGS

Polyamide PA 66 fittings over brass fittings:

Lighter, but with very good mechanical and thermal characteristics:

- better corrosion resistance
- more resistant to weathering
- 100% not toxic

Polypropylene PP fittings over PVC fittings: performance advantages:

- wider working temperature range
- better mechanical strength
- better bending strength

Avantages

LES AVANTAGES DES RACCORDS

Polyamide PA 66 par rapport au laiton:

ils sont **plus légers**, mais ils maintiennent aussi des caractéristiques optimales, mécaniques, thermiques et **supérieurs** en ce respect :

- résistance à la corrosion
- résistance aux agents atmosphériques
- complète atoxicité

Polypropylène PP par rapport au PVC, en termes de performance :

- gamme plus grande de température de service
- résistance mécanique supérieure
- résistance à la flexion supérieure

CARATTERISTICHE PRINCIPALI

MAIN CHARACTERISTICS

CARACTÉRISTIQUES
PRINCIPALES

Standard di connessione

Connection standards

Standards de connexion

Linea Line Ligne	Giunzioni	Joints	Jonction
2000 8000 4000 7000	raccordi filettati , secondo le seguenti norme: <ul style="list-style-type: none"> • con filettatura interna: gas cilindrico UNI ISO 228/1 • con filettatura esterna: gas cilindrico UNI ISO 228/1 	threaded fittings , in compliance with the following standards: <ul style="list-style-type: none"> • with internal thread: GAS parallel threading, UNI ISO 228/1 • with external thread: GAS parallel threading, UNI ISO 228/1 	raccords filetés , selon les normes suivantes : <ul style="list-style-type: none"> • avec filet intérieur : gaz cylindrique UNI ISO 228/1 • avec filet extérieur : gaz cylindrique UNI ISO 228/1
8000 4000 7000	bocchettone-ghiera <ul style="list-style-type: none"> • con filettatura interna: passo metrico 	union-ring nut <ul style="list-style-type: none"> • with internal thread: metric pitch 	raccord union-écrou <ul style="list-style-type: none"> • avec filet intérieur : pas métrique
7000	raccordi per saldatura nel bicchiere - serie metrica, secondo le seguenti norme: <ul style="list-style-type: none"> • DIN 16962, accoppiabili con tubi secondo EN ISO 15494, DIN 8077, UNI EN ISO 15874-2 collare d'appoggio per flangia secondo DIN 16962-12	fittings for socket fusion welding - metric series, in compliance with the following standards: <ul style="list-style-type: none"> • DIN 16962, coupled with pipes in accordance with EN ISO 15494, DIN 8077, UNI EN ISO 15874-2 supporting collar for flange in compliance with DIN 16962-12	raccords pour soudure dans l'embout - série métrique, selon les normes suivantes : <ul style="list-style-type: none"> • DIN 16962, couplables aux tuyaux selon EN ISO 15494, DIN 8077, UNI EN ISO 15874-2 collier de support pour bride selon DIN 16962-12
7000	raccordi di passaggio , secondo le seguenti norme: <ul style="list-style-type: none"> • filettatura: UNI ISO 228/1 • saldatura nel bicchiere: DIN 16962 	adaptor fittings , in compliance with the following standards: <ul style="list-style-type: none"> • threading: UNI ISO 228/1 • socket fusion welding: DIN 16962 	raccords de passage , selon les normes suivantes : <ul style="list-style-type: none"> • filet: UNI ISO 228/1 • soudure dans l'embout : DIN 16962
2000 8000 4000 7000	raccordi portagomma giunzione con tubi flessibili: <ul style="list-style-type: none"> • in PVC plastificato monostrato • in PVC plastificato con spirale in PVC rigido antiurto o metallico e altro rinforzo • in PU con spirale in PVC rigido antiurto o metallico, miscela di PVC o miscela termoplastica o gomma termoplastica con spirale in acciaio e altro rinforzo • a struttura appiattibile in miscela di PVC • superficie interna liscia ed esterna semiliscia o liscia o corrugata, serie metrica e gas attacchi filettati, secondo le seguenti norme: <ul style="list-style-type: none"> • con filettatura interna ghiera mobile: gas cilindrico UNI ISO 228/1 • con filettatura esterna: gas cilindrico UNI ISO 228/1 	hose couplings union with flexible pipes: <ul style="list-style-type: none"> • single layer, plasticized PVC • plasticized PVC with high-impact rigid PVC or metal spiral and a further reinforcement • PU, with spiral made of rigid high-impact PVC or metal, PVC compound, or thermoplastic compound, or thermoplastic rubber with steel spiral and a further reinforcement • wrapping structure made of PVC compound • Smooth internal surface; semi-smooth, smooth or corrugated external surface, metric or GAS series threaded couplings, in compliance with the following standards: <ul style="list-style-type: none"> • with internal thread mobile ring nut: GAS parallel threading, UNI ISO 228/1 • with external thread: GAS parallel threading, UNI ISO 228/1 	embouts cannelés jonction avec tuyaux flexibles : <ul style="list-style-type: none"> • en PVC plastifié monocouche • en PVC plastifié avec spirale en PVC rigide anti-choc ou métallique et autre renfort • en PU avec spirale en PVC rigide anti-choc ou métallique, mélange de PVC ou mélange thermoplastique avec spirale en acier et autre renfort • avec structure rabattable à plat en mélange de PVC • surface intérieure lisse et extérieure semi-lisse ou lisse ou plissé, série métrique et gaz raccords filetés, selon les normes suivantes : <ul style="list-style-type: none"> • avec filet intérieur écrou mobile : gaz cylindrique UNI ISO 228/1 • avec filet extérieur : gaz cylindrique UNI ISO 228/1
2000	raccordi tre pezzi attacchi filettati, secondo le seguenti norme e caratteristiche: <ul style="list-style-type: none"> • con filettatura interna ghiera mobile: passo metrico • con filettatura esterna: passo metrico attacchi conici <ul style="list-style-type: none"> • con sede conica interna • con sede conica esterna 	three-piece fittings threaded couplings, in compliance with the following standards: <ul style="list-style-type: none"> • with internal thread mobile ring nut: metric pitch • with external thread: metric pitch taper couplings <ul style="list-style-type: none"> • with internal taper seat • with external taper seat 	raccords trois pièces raccords filetés, selon les normes et les caractéristiques suivantes : <ul style="list-style-type: none"> • avec filet intérieur écrou mobile : pas métrique • avec filet extérieur : pas métrique connexions coniques <ul style="list-style-type: none"> • avec siège conique interne • avec siège conique externe

Tenuta idraulica

Hydraulic tightness

Étanchéité hydraulique

Linea Line Ligne	Su giunzioni e raccomandazioni	For gaskets and recommendations	Pour joints et recommandations
	raccordi filettati	threaded fittings	raccords filetés
2-8-4-7000	<ul style="list-style-type: none"> • <i>estremità con filettatura esterna-interna</i>: mediante interposizione di nastro PTFE o prodotti sigillanti 	<ul style="list-style-type: none"> • <i>end with external/internal thread</i>: by interposing PTFE tape or sealant 	<ul style="list-style-type: none"> • <i>extrémité avec filet extérieur-intérieur</i> : application de ruban en PTFE ou produits scellants
2-8-4-7000	<ul style="list-style-type: none"> • calotta: con guarnizione piana 	<ul style="list-style-type: none"> • cap: with flat gasket 	<ul style="list-style-type: none"> • bouchon : avec joint plat
7000	<ul style="list-style-type: none"> • collare d'appoggio: è prevista la guarnizione piana 	<ul style="list-style-type: none"> • supporting collar: there is a flat gasket 	<ul style="list-style-type: none"> • collier de support : le joint plat est prévu
8-4-7000	<ul style="list-style-type: none"> • bocchettone: con guarnizione O-ring 	<ul style="list-style-type: none"> • union: with O-ring gasket 	<ul style="list-style-type: none"> • raccord union : avec joint torique
8-4-3000	<ul style="list-style-type: none"> • attacchi per serbatoi: con guarnizione piana 	<ul style="list-style-type: none"> • tank adaptors: with flat gasket 	<ul style="list-style-type: none"> • raccords pour réservoirs : avec joint plat
	raccordi portagomma	hose couplings	embouts cannelés
2-8-4-7000	<ul style="list-style-type: none"> • <i>estremità con filettatura interna</i> ghiera mobile: con guarnizione piana 	<ul style="list-style-type: none"> • <i>end with internal thread</i> mobile ring nut: with flat gasket 	<ul style="list-style-type: none"> • <i>extrémité avec filet intérieur</i> écrou mobile : avec joint plat
2-8-4-7000	<ul style="list-style-type: none"> • <i>estremità con filettatura esterna</i>: mediante interposizione di nastro PTFE o prodotti sigillanti 	<ul style="list-style-type: none"> • <i>end with external thread</i>: by interposing PTFE tape or sealant 	<ul style="list-style-type: none"> • <i>extrémité avec filet extérieur</i> : application de ruban en PTFE ou produits scellants
2-8-4000	<ul style="list-style-type: none"> • <i>estremità con filettatura esterna</i> con sede O-ring: con O-ring 	<ul style="list-style-type: none"> • <i>end with external thread</i> with place to fit O-ring: with O-ring 	<ul style="list-style-type: none"> • <i>extrémité avec filet extérieur</i> avec siège joint torique : avec joint torique
4000	<ul style="list-style-type: none"> • <i>estremità con attacco passaparete</i>: con guarnizione piana • <i>estremità con battuta ampia</i> per attacco passa parete: con guarnizione piana 	<ul style="list-style-type: none"> • <i>end with passwall connector</i>: with flat gasket • <i>end with large stop</i> for passwall connector: with flat gasket 	<ul style="list-style-type: none"> • <i>extrémité avec raccord passe-paroi</i> : avec joint plat • <i>extrémité avec grande butée</i> pour raccord passe-paroi : avec joint plat
2000	raccordi tre pezzi	three-piece fittings	raccords trois pièces
	<ul style="list-style-type: none"> • <i>estremità con sede conica</i>: accoppiamento conico 	<ul style="list-style-type: none"> • <i>end with taper seat</i>: taper coupling 	<ul style="list-style-type: none"> • <i>extrémité avec siège conique</i> : jonction conique
2000	raccordi	fittings	raccords
	<ul style="list-style-type: none"> • <i>estremità con sede conica</i>: accoppiamento conico 	<ul style="list-style-type: none"> • <i>end with taper seat</i>: taper coupling 	<ul style="list-style-type: none"> • <i>extrémité avec siège conique</i> : jonction conique
	Nuova tecnologia di tenuta con l'O-ring	New tightness technology with O-rings	Nouvelle technologie de tenue avec joint torique
2-8-4000	raccordi portagomma	hose couplings	embouts cannelés
	<ul style="list-style-type: none"> • <i>estremità con filettatura esterna</i> con sede O-ring: con O-ring 	<ul style="list-style-type: none"> • <i>end with external thread</i> with place to fit O-ring: with O-ring 	<ul style="list-style-type: none"> • <i>extrémité avec filet extérieur</i> avec siège joint torique : avec joint torique

I vantaggi sono:

- **Sicurezza di tenuta** garantita da un O-ring di larga sezione.
- **Facilità/rapidità d'installazione** senza l'utilizzo di nastro al PTFE o prodotti sigillanti.

Advantages:

- **Perfect tightness** guaranteed by a large-section O-ring.
- **Simple, fast and easy fit.** No need for PTFE tape or sealants.

Les avantages sont :

- **Sécurité de tenue** garantie par un joint torique avec large section.
- **Facilité/rapidité d'installation** sans utiliser le ruban en PTFE ou des produits scellants

Istruzioni per l'installazione dei raccordi filettati

Preparazione dei raccordi secondo l'Avvertenza indicata nello Standard di connessione.

Predisposizione dei raccordi per i collegamenti.

- 1 Applicare i prodotti sigillanti sui filetti.
Numero di giri raccomandati di LOCTITE 55 per ogni misura di raccordo.

Ø	1/2"	3/4"	1"	1" 1/2	2"
N. GIRI - TWISTS - N° TOURS	6-8	7-9	8-12	10-15	15-25

- 2 Avvitare manualmente i raccordi fra di loro (es. di come creare un collettore allineando gli attacchi laterali).

- 3 L'avvitamento deve essere effettuato totalmente, stringendoli con la chiave ma senza forzare eccessivamente e contemporaneamente creare l'allineamento.



Gli accessori

L'UTILIZZO DI PRODOTTI SIGILLANTI

Per una perfetta tenuta idraulica la Bucchi propone i seguenti sigillaraccordi:

0800922

SIGILLANTE MULTIFIBRA IN NYLON LOCTITE 55

applicabile su filettature in plastica o in metallo.

MULTIFIBER NYLON SEALANT LOCTITE 55

to be smeared over plastic or metal threads.

SCCELLANT MULTIFIBRE EN NYLON LOCTITE 55

applicable sur les filets en plastique ou en métal.



I sigillaraccordi hanno i seguenti vantaggi:

- Sostituiscono i tradizionali nastri in PTFE, canapa e paste
- Assicurano il contatto completo tra filettature e garantiscono una tenuta al 100%
- Non si ritirano, non colano andando ad ostruire altre parti, filtri compresi, perché non sfilacciano
- Lo smontaggio è agevole ed eseguibile con normali utensili (per il prodotto, le caratteristiche e le istruzioni d'uso vedi relativo opuscolo)

Installation instructions for threaded fittings

How to prepare fittings following the instructions in the Connection standards section.

Preparing fittings for the connections.

- 1 Apply sealant on threading.
Recommended number of turns according to fitting diameter, with LOCTITE 55.

- 2 Manually make fittings fit (how to create a collector by aligning side fittings).

- 3 Screw tight with a wrench, do not force or tighten in excess. Align while tightening.



Accessories

USE OF SEALING PRODUCTS

For perfect tightness Bucchi recommends the following sealants:

0800923

SIGILLANTE GEL POLIMERIZZANTE LOCTITE 5331

applicabile su filettature in plastica o plastica/metallo.

POLYMERIZING SEALANT GEL LOCTITE 5331

to be smeared over plastic or plastic/metal threads.

SCCELLANT EN GEL POLYMERISANT LOCTITE 5331

applicable sur les filets en plastique ou en plastique/métal.



Sealants offer the following advantages:

- They replace the usual PTFE tape, hemp and pastes
- They ensure full contact between threads and guarantee 100% tightness
- They do not shrink, do not run and do not clog other parts –including filters, because they do not fray
- They can be easily disassembled with normal tools (for product, characteristics and instructions for use see relevant folder)

Instructions d'installation des raccords filetés

Préparation des raccords selon l'avertissement indiqué dans le standard de connexion.

Disposition des raccords pour les connexions.

- 1 Appliquer les produits scellants sur les filets.
Numéro de tours recommandés de LOCTITE 55 pour chaque mesure de raccord.

- 2 Visser les raccords à main (dans l'exemple, la création d'un collecteur en alignant les connexions laterales).

- 3 Visser complètement à l'aide d'une clé, mais sans forcer excessivement et, au même temps, aligner.



Accessoires

UTILISATION DE PRODUITS SCCELLANTS

Pour une parfaite étanchéité hydraulique, Bucchi recommande les produits scellants pour raccords suivants :

LE APPLICAZIONI

Il sistema **tech evolution**, costituisce la vera alternativa all'utilizzo del metallo per il trasporto e la distribuzione di acqua potabile per uso domestico e calda e fredda per uso industriale.

Il sistema tech evolution

LINEA 9000

APPLICATIONS

The **tech evolution** system is the one real alternative to the use of metal for carrying and distributing drinking water for household use, and hot/cold water for industrial purposes.

The tech evolution system

9000 LINE

APPLICATIONS

Le système **tech evolution** est la véritable alternative au métal pour le transport et la distribution de l'eau potable dans les maisons et l'eau chaude et froide pour emploi industriel.

Le système tech evolution

LIGNE 9000



Settori applicativi, professionale,
tipo di impianti:



Nautico - Nautical - Nautique

Fields of Application, professional,
type of installations:



Industriale - Industrial - Industriel

Secteurs d'application, professionnel,
type d'installations :



Autolavaggi - Car wash systems -
Stations de lavage

Vantaggi

I vantaggi del sistema tech evolution sono:

- Risparmio economico rispetto all'acciaio
- Durata rispetto all'acciaio zincato
- Rapidità e semplicità d'installazione
Si riduce il tempo di installazione del 30-50% rispetto ai sistemi metallici tradizionali.
- Resistenza alla bassa e alta temperatura superiore al PVC

Advantages

Tech evolution system advantages:

- More cost-efficient compared with steel
- Longer life compared with galvanised steel
- Simple, fast and easy fit
Installation time is reduced by 30-50% compared with installation of traditional metal systems.
- Better resistance to low and high temperatures than PVC

Avantages

Les avantages du système tech evolution sont :

- Économie par rapport à l'acier
- Plus grande durée par rapport à l'acier galvanisé
- Installation rapide et simple
Le temps d'installation est réduit du 30-50% par rapport au systèmes métalliques traditionnels.
- Résistance à la basse et haute température meilleure par rapport au PVC

I COMPONENTI

COMPONENTS

LES COMPOSANTS

Settori applicativi, tipo:

Fields of Application, type:

Secteurs d'application, type :

LINEA 2000 / 2000 LINE / LIGNE 2000



LINEA 8000 / 8000 LINE / LIGNE 8000



LINEA 4000 / 4000 LINE / LIGNE 4000



LINEA 7000 / 7000 LINE / LIGNE 7000



LINEA 3000 E 2000

Le valvole di ritegno e di fondo in Resina Acetalica e le valvole a sfera enologiche in Polipropilene sono nati nella Bucchi alla fine degli anni 70 come innovazione dei materiali.

3000 AND 2000 LINES

Acetal resin check and foot valves and polypropylene ball valves for the wine industry were first manufactured by Bucchi at the end of the '70s as an innovation in the materials used.

LIGNE 3000 ET 2000

Les clapets de retenue et de fond en résine acétalique et les vannes à bille œnologiques en polypropylène ont été produites par Bucchi à partir de la fin des années 70 avec des matériaux innovants.

LINEA 3000 / 3000 LINE / LIGNE 3000



Accessori:
Accessories:
Accessoires :



Enologia: Mastellone, Contenitore Enologico
Wine industry: Vat, tank for oenological uses
Oenologie : Cuve, Conteneur œnologique



CARATTERISTICHE GENERALI

GENERAL CHARACTERISTICS

CARACTÉRISTIQUES GÉNÉRALES

Certificazioni

VALVOLE PER LIQUIDI ALIMENTARI*

Le valvole a sfera in Polipropilene sono compatibili al contatto con i liquidi alimentari secondo la Direttiva Europea 2002/72/CE e successivi aggiornamenti - classi A,B,C, con limitazione per gli alimenti grassi a temperatura uguali o inferiori a temperatura ambiente

Le valvole di fondo e di ritegno in Resina Acetilenica sono compatibili al contatto con i liquidi alimentari secondo la Direttiva 2002/72/CE e successivi aggiornamenti - classi A,B,C. Tutti i nostri prodotti sono esenti da ftalati e plastificanti.

*Contattare i nostri uffici per maggiori informazioni

Certifications

VALVES FOR FOOD LIQUIDS*

The ball valves in polypropylene are suitable for contact with food liquids according to EU Directive 2002/72/EC and following changes – classes A, B, C with some restrictions for fatty foods at temperature equal or lower than room temperature.

The foot valves and check valves in acetal resin are suitable for contact with food liquids according to EU Directive 2002/72/CE and following changes - classes A, B, C.

All our products are clear of phthalates and plasticizing materials.

*For further information please get in touch with our offices.

Certifications

VANNES POUR LIQUIDES ALIMENTAIRES*

Les vannes à bille en polypropylène sont compatibles au contact avec les liquides alimentaires selon la Directive Européenne 2002/72/CE et modifications ultérieures - classes A, B, C avec limitation pour les aliments gras à la même ou à une température inférieure à la température ambiante.

Les clapets de pied et de retenue en résine acétalique sont compatibles au contact avec les liquides alimentaires selon la Directive 2002/72/CE et modifications ultérieures - classes A, B, C.

Tous nos produits sont libres de phthalates et plastifiants.

*Contacter nos bureaux pour plus d'informations

Colore

Colour

Couleur

Linea Line Ligne	Valvole a sfera "ARIES"	"ARIES" ball valves	Vannes à bille "ARIES"
2-8-4-7000	Corpo: nero similare a RAL 9011	Body: black, similar to RAL 9011	Corps : noir similare au RAL 9011
3000	Corpo: bianco RAL 9003	Body: white RAL 9003	Corps : blanc RAL 9003
2-8-4000	Maniglia: nero similare a RAL 9011	Handle: black, similar to RAL 9011	Manette : noir similare au RAL 9011
7-3000	Maniglia: rosso RAL 3031	Handle: red RAL 3031	Manette : rouge RAL 3031
	Valvole a cilindro	Cylinder valves	Vannes cylindriques
4000	Corpo, maniglia, ghiera mobile: nero similare a RAL 9011 Ghiera sul porta gomma a stringere: grigio similare a RAL 7047	Body, handle, mobile ring nut: black, similar to RAL 9011 Ring nut on clamping hose coupling: grey similar to RAL 7047	Corps, manette, écrou mobile : noir similare au RAL 9011 Écrou sur l'embout cannelé à serrer : gris similare au RAL 7047
	Rubinetti	Cocks	Robinets
8000	grigio similare RAL 7015	grey, similar to RAL 7015	gris similare au RAL 7015
	Valvole di fondo	Foot valves	Clapets de pied
2000	(1"1/4-1"1/2-2") Corpo e Filtro: naturale, similare a RAL 9003 Yuri (1/2"-3/4"-1") Corpo: naturale similare 9003 e Filtro: nero similare a RAL 9011	(1"1/4-1"1/2-2") Body and filter: natural, similar to RAL 9003 Yuri (1/2"-3/4"-1") Body: natural, similar to 9003, and Filter: black, similar to RAL 9011	(1"1/4-1"1/2-2") Corps et Crépine : naturel, similare au RAL 9003 Yuri (1/2"-3/4"-1") Corps : naturel similare 9003 et Crépine : noir similare au RAL 9011
	Valvole di fondo e di ritegno "YURI"	"YURI" foot and check valves	Clapets de pied et de retenue "YURI"
2-8000	Filtro: nero RAL 9011 Corpo: grigio RAL 7032	Filter: black RAL 9011 Body: grey RAL 7032	Crépine : noir 9011 Corps : gris RAL 7032
	Valvole di fondo "YURI" (1")	"YURI" foot valves (1")	Clapets de pied "YURI" (1")
4000	Corpo e Filtro: nero similare a RAL 9011	Body and filter: black, similar to RAL 9011	Corps et Crépine: noir similare au RAL 9011

Prestazioni

Valvole	Modello	Linea				
		2000	8000	4000	7000	3000
Pressione di esercizio: 10 bar a 20°C	a sfera auto registrante e monoghiera "ARIES"	X	X	X	X	X
Temperatura max di esercizio 80°C		X	X	X	X	X
Temperatura minima 0°C		X	X	X	X	X
Ottima stabilità termica: soprattutto nel campo di temperatura intermedia fra 10 °C e 80 °C il PP-H trova il suo tipico impiego, garantendo prestazioni di eccellente resistenza meccanica ed all'urto con elevati fattori di sicurezza		X	X	X	X	X
Durata nel tempo grazie alla struttura del polipropilene che resiste alle sollecitazioni termiche e meccaniche, agli agenti atmosferici ed ai raggi UV		X	X	X	X	X
Buona resistenza chimica: resiste al contatto con soluzioni acquose di sali inorganici, acidi deboli inorganici e soluzioni alcaline, alcool o alcuni oli. Inoltre mantiene elevate caratteristiche meccaniche anche nel trasporto di detergenti e prodotti chimici simili.		X	X	X	X	X
Absoluta atossicità: le resine PPH FV offrono completa compatibilità anche nel trasporto di fluidi alimentari, di acqua potabile e da potabilizzare, di acque demineralizzate secondo le vigenti norme nazionali ed internazionali.		X	X	X	X	X
Pressione max di esercizio: 1 bar a 20°C	a cilindro			X		
Temperatura max di esercizio 80°C						
Ottima resistenza alle basse temperature						
Altre prestazioni: come le valvole a sfera						
Pressione di esercizio: 3 bar a 20°C	rubinetti		X			
Temperatura max di esercizio 80°C						
Durata nel tempo grazie alla struttura del polipropilene che resiste alle sollecitazioni termiche e meccaniche, agli agenti atmosferici ed ai raggi UV						
Buona resistenza chimica (come le valvole a sfera in PP)						
Absoluta atossicità: le resine PPH offrono completa compatibilità anche nel trasporto di fluidi alimentari, acqua potabile e da potabilizzare, di acque demineralizzate secondo le vigenti norme nazionali ed internazionali.						
Pressione di esercizio: 10 bar a 20°C	di ritegno "YURI" in POM	X				
Temperatura max di esercizio 85°C						
Altre prestazioni: come valvole di fondo in POM						
Pressione di esercizio: 6 bar a 20°C	di ritegno "YURI" in PP		X	X		
Temperatura max di esercizio 80°C						
Ottima resistenza alle basse temperature						
Durata nel tempo grazie alla struttura del polipropilene che resiste alle sollecitazioni termiche e meccaniche, agli agenti atmosferici ed ai raggi UV						
Buona resistenza chimica (come le valvole a sfera in PP)						
Absoluta atossicità: le resine PPH – PPH FV offrono completa compatibilità anche nel trasporto di fluidi alimentari, acqua potabile e da potabilizzare, di acque demineralizzate secondo le vigenti norme nazionali ed internazionali.						
Temperatura max di esercizio 85°C	di fondo (1"1/4-1"1/2-2") e "YURI" (1/2", 3/4", 1") (in POM)	X				
Ottima resistenza alle basse temperature						
Ottima stabilità termica: soprattutto nel campo di temperatura intermedia fra 10 °C e 80 °C il POM trova il suo tipico impiego, garantendo prestazioni di eccellente resistenza meccanica ed all'urto con elevati fattori di sicurezza						
Durata nel tempo grazie alla struttura della resina acetalica POM che resiste alle sollecitazioni termiche e meccaniche, agli agenti atmosferici ed ai raggi UV						
Buona resistenza chimica al contatto con acetone, etere, benzina, olio combustibile, oli e grassi, alcali deboli.						
Temperatura max di esercizio 80°C	di fondo "YURI" (1/2", 3/4", 1") (in PP)	X	X	X		
Absoluta atossicità: le resine PP offrono completa compatibilità anche nel trasporto di liquidi alimentari, di acqua potabile e da potabilizzare, di acque demineralizzate secondo le vigenti norme nazionali ed internazionali.						
Altre prestazioni: non rilevanti						

Performance

Valves	Model	Line				
		2000	8000	4000	7000	3000
Working pressure: 10 bar at 20°C	ball valve, self-adjusting and with one ring nut, "ARIES"	X	X	X	X	X
Max. working temperature: 80°C		X	X	X	X	X
Minimum temperature 0°C		X	X	X	X	X
Very good shape permanence to heat: PP-H performs best mainly within an intermediate temperature range- 10 °C and 80 °C-, guaranteeing excellent mechanical and impact strength, plus high safety factors		X	X	X	X	X
Long life, due to the structure of polypropylene which endures thermal and mechanical stress, weather conditions, and UV rays		X	X	X	X	X
Good resistance to chemicals: resistant to contact with inorganic salts in aqueous solutions, weak inorganic acids and alkaline solutions, alcohol and some oils. Very good mechanical characteristics also when carrying detergents and similar chemicals.		X	X	X	X	X
100% not toxic: PPH FV resins are fully compatible to carry liquid foods, drinking water, water to be made potable, de-mineralised water in compliance with the national and international legislation in force.		X	X	X	X	X
Max. working pressure: 1 bar at 20°C	cylinder valve			X		
Max. working temperature: 80°C						
Very good resistance to low temperatures						
Other features: like ball valves						
Working pressure: 3 bar at 20°C	cocks		X			
Max. working temperature: 80°C						
Long life, due to the structure of polypropylene which endures thermal and mechanical stress, weather conditions, and UV rays						
Good resistance to chemicals (like PP ball valves)						
100% not toxic: PPH resins are fully compatible to carry liquid foods, drinking water, water to be made potable, de-mineralised water in compliance with the national and international legislation in force.						
Working pressure: 10 bar at 20°C	"YURI" check valve, POM	X				
Max. working temperature: 85°C						
Other features: Like POM foot valves						
Working pressure: 6 bar at 20°C	"YURI" check valve, PP		X	X		
Max. working temperature: 80°C						
Very good resistance to low temperatures						
Long life, due to the structure of polypropylene which endures thermal and mechanical stress, weather conditions, and UV rays						
Good resistance to chemicals (like PP ball valves)						
100% not toxic: PPH – PPH FV resins are fully compatible to carry liquid foods, drinking water, water to be made potable, de-mineralised water in compliance with the national and international legislation in force.						
Max. working temperature: 85°C	foot valve (1"1/4-1"1/2-2") and "YURI" (1/2", 3/4", 1") (POM)	X				
Very good resistance to low temperatures						
Very good shape permanence to heat: POM performs best mainly within an intermediate temperature range- 10 °C and 80 °C-, guaranteeing excellent mechanical and impact strength, plus high safety factors						
Long life, due to the structure of the acetal resin POM which endures thermal and mechanical stress, weather conditions, and UV rays						
Good resistance to chemicals when in contact with acetone, ether, petrol, fuel oil, oils and fats, weak alkalis.						
Max. working temperature: 80°C	"YURI" foot valve, (1/2", 3/4", 1") (PP)	X	X	X		
100% not toxic: PP resins are fully compatible to carry liquid foods, drinking water, water to be made potable, de-mineralised water in compliance with the national and international legislation in force.						
Other features: Not significant						

Performance

Vannes	Modèle	Ligne				
		2000	8000	4000	7000	3000
Pression de service : 10 bar à 20°C	à bille autoréglable avec un seul écrou "ARIES"	X	X	X	X	X
Température maximum de service 80°C		X	X	X	X	X
Température minimum 0°C		X	X	X	X	X
Stabilité thermique excellente : surtout à une température intermédiaire entre 10 °C et 80 °C, le PPH trouve son emploi typique, garantissant une excellente résistance mécanique et au choc avec des facteurs de sécurité élevés		X	X	X	X	X
Durée dans le temps grâce à la structure du polypropylène, qui résiste aux sollicitations thermiques et mécaniques, aux agents atmosphériques et aux rayons UV		X	X	X	X	X
Bonne résistance chimique : résiste au contact avec des solutions aqueuses de sels inorganiques, acides faibles inorganiques et solutions alcalines, alcool ou des huiles. En outre, maintient des propriétés mécaniques élevées aussi dans le transport des détergents et de produits chimiques similaires.		X	X	X	X	X
Complète atoxicité : les résines PPH FV sont totalement compatibles aussi dans le transport de liquides alimentaires, eau potable et à potabiliser, eau déminéralisée selon les normes nationales et internationales.		X	X	X	X	X
Pression max de service : 1 bar à 20°C	cylindriques			X		
Température maximum de service 80°C						
Résistance excellente aux basses températures						
Autres performances : comme les vannes à bille						
Pression de service : 3 bar à 20°C	robinets		X			
Température maximum de service 80°C						
Durée dans le temps grâce à la structure du polypropylène, qui résiste aux sollicitations thermiques et mécaniques, aux agents atmosphériques et aux rayons UV						
Bonne résistance chimique (comme les vannes à bille en PP)						
Complète atoxicité : les résines PPH sont totalement compatibles aussi dans le transport de liquides alimentaires, eau potable et à potabiliser, eau déminéralisée selon les normes nationales et internationales.						
Pression de service : 10 bar à 20°C	de retenue "YURI" en POM	X				
Température maximum de service 85°C						
Autres performances : comme les clapets de pied en POM						
Pression de service : 6 bar à 20°C	de retenue "YURI" en PP		X	X		
Température maximum de service 80°C						
Résistance excellente aux basses températures						
Durée dans le temps grâce à la structure du polypropylène, qui résiste aux sollicitations thermiques et mécaniques, aux agents atmosphériques et aux rayons UV						
Bonne résistance chimique (comme les vannes à bille en PP)						
Complète atoxicité : les résines PPH - PPH FV sont totalement compatibles aussi dans le transport de liquides alimentaires, eau potable et à potabiliser, eau déminéralisée selon les normes nationales et internationales.						
Température maximum de service 85°C	de pied (1"1/4-1"1/2-2") et "YURI" (1/2", 3/4", 1") (en POM)	X				
Résistance excellente aux basses températures						
Stabilité thermique excellente : surtout à une température intermédiaire entre 10 °C et 80 °C, le POM trouve son emploi typique, garantissant une excellente résistance mécanique et au choc avec des facteurs de sécurité élevés						
Durée dans le temps grâce à la structure de la résine acétalique POM, qui résiste aux sollicitations thermiques et mécaniques, aux agents atmosphériques et aux rayons UV.						
Bonne résistance chimique au contact avec acétone, éther, essence, huile combustible, huiles et graisses, alcali faible.						
Température maximum de service 80°C	de pied "YURI" (1/2", 3/4", 1") (en PP)	X	X	X		
Complète atoxicité : les résines PP sont totalement compatibles aussi dans le transport de liquides alimentaires, eau potable et à potabiliser, eau déminéralisée selon les normes nationales et internationales.						
Autres performances : pas importantes						

CONDIZIONI MASSIME DI ESERCIZIO

Diagramma della variazione della pressione in funzione della temperatura per acqua o fluidi nei confronti dei quali PP sono classificati chimicamente idonei

PP-PN 10

Temperatura Max Max Temperature Température max	Durata Anni Working life Durée	Pressioni di esercizio massime Operating pressure maximum Pression de service maximum
20 °C	10	12 bar
	50	10 bar
40 °C	10	8 bar
	50	6 bar
60 °C	10	5 bar
	50	3 bar
80 °C	10	2,5 bar
	50	1 bar

PP-PN 6

Temperatura Max Max Temperature Température max	Durata Anni Working life Durée	Pressioni di esercizio massime Operating pressure maximum Pression de service maximum
20 °C	10	7,2 bar
	50	6 bar
40 °C	10	5 bar
	50	3,6 bar
60 °C	10	3 bar
	50	1,8 bar
80 °C	10	1,5 bar
	50	0,6 bar

VANTAGGI

I vantaggi delle valvole di ritegno e di fondo in Resina Acetalica POM rispetto alle valvole in:

- Ottone: migliore resistenza alla corrosione
- Ottone: migliore resistenza agli agenti atmosferici
- Ottone: assoluta atossicità
- Ottone e PVC: migliore resistenza alla bassa temperatura
- PVC: migliore resistenza alla alta temperatura

I vantaggi delle valvole a sfera in polipropilene PPH FV rispetto alle valvole in ottone:

- migliore resistenza alla corrosione
- migliore resistenza agli agenti atmosferici
- assoluta atossicità

MAXIMUM OPERATING CONDITIONS

Diagram illustrating the operating pressure change in response to water or fluid temperature for which PP has been classified chemically resistant.

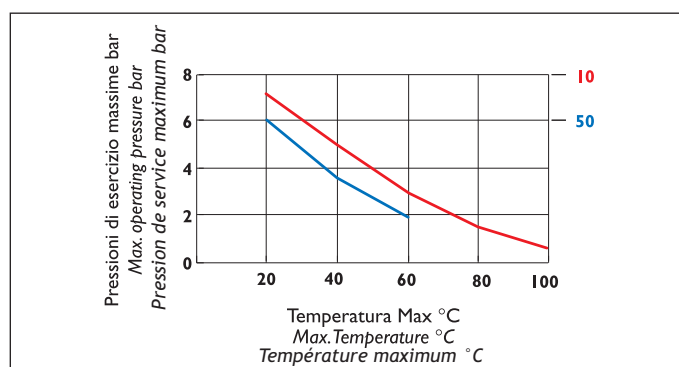
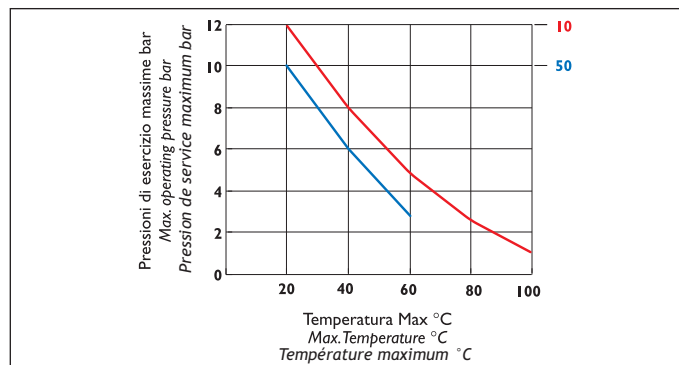

ADVANTAGES

Advantages of check and foot valves made of acetal resin POM over valves made of:

- Brass: better corrosion resistance
- Brass: more resistant to weathering
- Brass: 100% not toxic
- Brass and PVC: Better resistance to low temperatures
- PVC: better resistance to high temperatures

Advantages of polypropylene PPH FV ball valves over brass valves:

- better corrosion resistance
- more resistant to weathering
- 100% not toxic

CONDITIONS MAXIMUM DE SERVICE

Diagramme de la variation de pression en fonction de la température pour eau ou fluides pour lesquels le PP est classifié chimiquement résistant.

Les avantages des clapets de retenue et de fond en résine acétalique POM par rapport aux vannes en:

- Laiton : meilleure résistance à la corrosion
- Laiton : meilleure résistance aux agents atmosphériques
- Laiton : complète atoxicité
- Laiton et PVC : meilleure résistance aux basses températures
- PVC : meilleure résistance aux hautes températures

Les avantages des vannes à bille en polypropylène PPH FV par rapport aux vannes en laiton :

- meilleure résistance à la corrosion
- meilleure résistance aux agents atmosphériques
- complète atoxicité

CARATTERISTICHE PRINCIPALI

MAIN CHARACTERISTICS

CARACTÉRISTIQUES PRINCIPALES

Valvole

Valves

Vannes

Linea Line Ligne	Valvole a sfera auto registrante e monoghiera "ARIES"	"ARIES" ball valves, self-adjusting and with one ring nut	Vannes à bille autoréglables et avec un seul écrou "ARIES"
2-4000	Valvole in Polipropilene rinforzato con fibre di vetro PPH FV	Valves made of fiberglass reinforced polypropylene PPH FV	Vannes en polypropylène renforcé avec fibre de verre PPH FV
	Sedi tenuta sfera in PTFE	PTFE ball seal seats	Sièges tenue bille en PTFE
	Guarnizioni O-ring in NBR	NBR O-ring gaskets	Joint toriques en NBR
	Manutenzione agevolata del solo tipo MONOGHIERA: facile smontaggio e rapida sostituzione delle o-ring e delle guarnizioni della sfera, senza l'impiego di alcun attrezzo	Easy to service, SINGLE RING NUT type: O-rings and ball gaskets are easy and quick to remove and replace. No tool required.	Entretien facile du seul type avec un SEUL ÉCROU : démontage facile et remplacement rapide des joints toriques et des joints de la bille, sans utiliser aucun outil
	Passaggio totale: il foro della sfera corrisponde al diametro interno del tubo	Full flow: ball orifice matches pipe inside diameter.	Passage total : le trou de la bille correspond au diamètre intérieur du tuyau
	Valvole a sfera auto registrante "ARIES"	"ARIES" ball valves, self-adjusting	"ARIES" ball valves, self-adjusting
3-7-8000	Valvole in Polipropilene rinforzato con fibre di vetro PPH FV	Valves made of fiberglass reinforced polypropylene PPH FV	Vannes en polypropylène renforcé avec fibre de verre PPH FV
	Sedi tenuta sfera in PTFE	PTFE ball seal seats	Sièges tenue bille en PTFE
7000	Guarnizioni O-ring in FPM	FPM O-ring gaskets	Joint toriques en FPM
8000	Guarnizioni O-ring in EPDM	EPDM O-ring gaskets	Joint toriques en EPDM
3000	Guarnizioni O-ring in NBR alimentare	NBR O-ring gaskets - foodstuffs	Joint toriques en NBR pour aliments
7-8-3000	Passaggio totale: il foro della sfera corrisponde al diametro interno del tubo	Full flow: ball orifice matches pipe inside diameter.	Passage total : le trou de la bille correspond au diamètre intérieur du tuyau
	Rubinetti	Cocks	Robinets
8000	Rubinetti in Polipropilene rinforzato con fibre di vetro PPH FV	Cocks made of fiberglass reinforced polypropylene PPH FV	Robinets en polypropylène renforcé avec fibre de verre PPH FV
	Guarnizioni O-ring in NBR	NBR O-ring gaskets	Joint toriques en NBR

PROVE E CERTIFICAZIONI

TESTS AND COMPLIANCE CERTIFICATIONS

ESSAIS ET CERTIFICATIONS

COPPIA DI MANOVRA ALLA MASSIMA PRESSIONE DI ESERCIZIO.

Il metodo di prova è conforme alla norma UNI 8895.

OPERATING TORQUE AT MAXIMUM OPERATING PRESSURE.

Testing methods comply with UNI 8895 standard.

COUPLE DE MANOEUVRE À LA PRESSION MAXIMUM DE SERVICE.

La méthode d'essai est conforme à la norme UNI 8895.

Valvola a sfera / Ball valve / Vanne à bille	Coppia di chiusura / Closing torque / Couple de fermeture [Nm]	Coppia di spunto in apertura / Breakaway torque / Couple de démarrage en ouverture [Nm]
Ø 1/2"	2,8	3,3
Ø 3/4"	4,1	4,9
Ø 1"	3,1	3,7

Coefficiente di portata / Flow coefficient / Coefficient de capacité

Valvola a sfera / Ball valve / Vanne à bille	Kv [m ³ /h]
Ø 1/2"	12,198
Ø 3/4"	23,827
Ø 1"	42,729

Si definisce coefficiente di flusso Kv il coefficiente caratteristico della valvola di ritegno e di fondo rappresentante la portata d'acqua, in m³/h, che determina una caduta di pressione di 1000 mbar (1 bar) attraversando la valvola stessa in posizione di completa apertura.

Flow coefficient Kv is defined as the typical check/ball valve coefficient representing the water flow rate in m³/h causing a pressure drop of 1000 mbar (1 bar) while passing through a fully open valve.

On appelle coefficient de flux Kv le coefficient caractéristique du clapet de retenue et de pied représentant la capacité en eau, en m³/h, qui détermine une tombée de pression de 1000 mbar (1 bar) en passant à travers le clapet en position d'ouverture totale.

DIAGRAMMA DELLE PERDITE DI CARICO BALL VALVES PRESSURE LOSS DIAGRAM DIAGRAMME DES PERTES DE CHARGE POUR VANNES À BILLES

ISTITUTO GIORDANO s.p.a.
CENTRO POLITECNICO DI RICERCHE

Via Rossini, 2
47041 BELLARIA (RN) Italy

Tel. ++ 39/10) 54 1/343000 (9 linee)
Telefax ++ 39/10) 54 1/345540

Cod. Fisc./Part. IVA: 00549540409
C.C.I.A.A. 1556765
Iscr. Reg. Soc. n. 1852
Clas. Soc. L. 1.200.000.000 Iw.

RAPPORTO DI PROVA N. 107898

Luogo e data di emissione: Bellaria, 22/04/1997

Committente: BUCCHI S.r.l. - Via Bonsi, 57 - 48022 LUGO (RA)

Data della richiesta della prova: 14/03/1997

Numero e data della commessa: 7185,24/03/1997

Data del ricevimento del campione: 21/03/1997

Data dell'esecuzione della prova: dal 26/03/1997 al 27/03/1997

Oggetto della prova: Rilievo della caratteristica idraulica di portata-perdita di carico e della coppia di manovra su valvole a sfera in polipropilene.

Luogo della prova: Istituto Giordano S.p.A. - Sezione 1 - Via Rossini, 2 - Bellaria (RN).

Provenienza del campione: dal Committente.

Identificazione del campione in accettazione: n.97/139c.

Denominazione del campione*.
Il campione sottoposto a prova è denominato "Valvola a sfera in polipropilene."

(*) secondo le dichiarazioni del Committente.

Comp. FM
Revis. CHL

Il presente rapporto di prova è composto da n. 5 fogli.

Foglio
n. 1 di 5

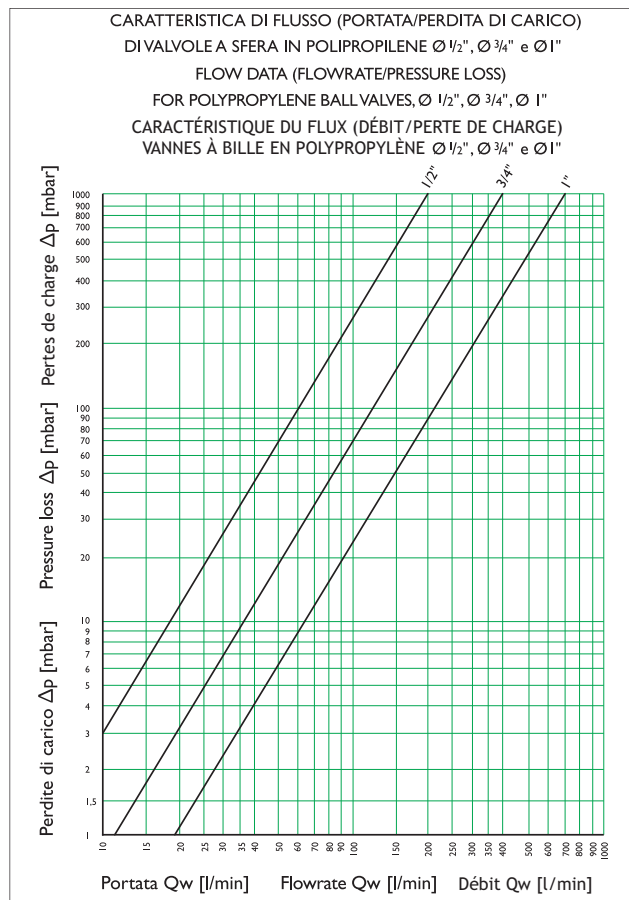

Linea Line Ligne	Valvole "YURI" di fondo e di ritegno "YURI" (1/2", 3/4", 1", 1"1/4, 1"1/2, 2")	Foot valves "YURI" and check valves "YURI" (1/2", 3/4", 1", 1"1/4, 1"1/2, 2")	Clapets de pied "YURI" et de retenue "YURI" (1/2", 3/4", 1", 1"1/4, 1"1/2, 2")
2000	Valvole in Resina Acetalica POM	Valves made of acetal resin POM	Vannes en résine acétalique POM
4000	Valvola di fondo in Polipropilene rinforzato con fibre di vetro PPH FV da 1"	Foot valves made of fiberglass reinforced polypropylene PPH FV 1"	Clapet de fond en polypropylène renforcé avec fibre de verre PPH FV de 1"
2-4000	Valvole in Polipropilene rinforzato con fibre di vetro PPH FV 1"	Valves made of fiberglass reinforced polypropylene PPH FV 1"	Vannes en polypropylène renforcé avec fibre de verre PPH FV 1"
2000	Otturatore: per le dimensioni 1/2", 3/4", 1" in Resina Acetalica POM; per le dimensioni 1"1/4, 1"1/2, 2" in PA 66 rinforzato con fibre di vetro	Obturator: for sizes 1/2", 3/4", 1", made of acetal resin POM; for sizes 1"1/4, 1"1/2, 2", made of fiberglass reinforced PA 66	Obturateur : pour les dimensions 1/2", 3/4", 1" en résine acétalique POM; pour les dimensions 1"1/4, 1"1/2, 2" en PA 66 renforcé avec fibre de verre
2-4000	Guarnizione piana in NBR per le dimensioni 1/2", 3/4", 1"	NBR flat gasket for sizes 1/2", 3/4", 1"	Joint plat en NBR pour les dimensions 1/2", 3/4", 1"
2000	Guarnizione O-ring in NBR nell'otturatore per le dimensioni 1"1/4, 1"1/2, 2"	NBR O-ring gasket in the obturator for sizes 1"1/4, 1"1/2, 2"	Joint torique en NBR dans l'obturateur pour les dimensions 1"1/4, 1"1/2, 2"
2-4000	Molla in acciaio AISI 316	Spring made of AISI 316 steel	Ressort en acier AISI 316
8000	<ul style="list-style-type: none"> Valvole in Polipropilene rinforzato con fibre di vetro PPH FV Otturatore in Resina Acetalica POM Guarnizione piana in EPDM Molla in acciaio AISI 316 	<ul style="list-style-type: none"> Valves made of fiberglass reinforced polypropylene PPH FV Obturator made of acetal resin POM EPDM flat gasket Spring made of AISI 316 steel 	<ul style="list-style-type: none"> Vannes en polypropylène renforcé avec fibre de verre PPH FV Obturateur en résine acétalique POM Joint plat en EPDM Ressort en acier AISI 316

Sono necessarie pressioni minime per il sollevamento dell'otturatore: *Minimum pressures are needed to lift the obturator:* *Des pressions minimums sont nécessaires pour le levage de l'obturateur :*

Dimensione Size Dimension	1/2"	3/4"	1"	1"1/4	1"1/2	2
Pressione Bar Pressure in Bar Pression en bar	0,012	0,027	0,017	0,007	0,004	0,004

La Valvola di ritegno ha la funzione di permettere il passaggio del fluido in una sola direzione, garantendo una protezione contro i ritorni d'acqua.

La valvola di fondo ha un filtro che permette di eliminare dal fluido di esercizio impurità solide. Le valvole di ritegno possono funzionare in ogni posizione: verticale, orizzontale, inclinata, capovolta. Tenuta perfetta da 0 a 15 kg/cm². Grazie alla nostra tecnologia e agli studi idraulici, le valvole di ritegno e di fondo non generano colpi d'ariete. Infatti l'otturatore muovendosi assialmente, risponde gradualmente con precisione all'azione della molla di richiamo non appena la pressione diminuisce, garantendo la chiusura.

Check valves permit liquids to flow in only one direction, preventing process water flow from reversing.

Foot valves feature a filter that removes solid impurities from the process flow. Check valves can operate in any position: vertical, horizontal, inclined, upside-down. Perfect sealing from 0 to 15 kg/cm².

Due to our technology and the studies on hydraulics, our check and foot valves do not cause water hammering. As a matter of fact, while moving axially, the obturator gradually responds with precision to the action of the return spring as soon as pressure drops, thus guaranteeing valve closing.

Le clapet de retenue a la fonction de permettre le passage du fluide dans une seule direction, garantissant ainsi la protection contre les retours de l'eau.

Le clapet de pied a un filtre qui permet d'éliminer du fluide d'exercice les impuretés solides. Les clapets de retenue peuvent fonctionner dans toutes les positions : verticale, horizontale, inclinée, renversée. Étanchéité parfaite de 0 à 15 kg/cm².

Grâce à notre technologie et aux études hydrauliques, les clapets de retenue et de pied ne génèrent pas de coups de bélier. En effet, l'obturateur se déplaçant en direction axiale, répond graduellement et avec précision à l'action du ressort de rappel dès que la pression diminue, ce qui garantit la fermeture.

Coefficiente di portata Kv per valvole di ritegno Flow coefficient Kv for check valves Coefficient de capacité Kv pour clapets de retenue		Coefficiente di portata Kv per valvole di fondo Flow coefficient Kv for foot valves Coefficient de capacité Kv pour clapets de pied	
Ø 1/2"	Kv [m ³ /h] 5,654	Ø 1"1/4	Kv [m ³ /h] 18,863
Ø 3/4"	9,349	Ø 1"1/2"	25,172
Ø 1"	14,224	Ø 2"	38,704

Si definisce coefficiente di flusso Kv il coefficiente caratteristico della valvola di ritegno e di fondo rappresentante la portata d'acqua, in m³/h, che determina una caduta di pressione di 1000 mbar (1 bar) attraversando la valvola stessa in posizione di completa apertura.

Flow coefficient Kv is defined as the typical check/foot valve coefficient representing the water flow rate in m³/h causing a pressure drop of 1000 mbar (1 bar) while passing through a fully open valve.

On appelle coefficient de flux Kv le coefficient caractéristique du clapet de retenue et de pied représentant la capacité en eau, en m³/h, qui détermine une tombée de pression de 1000 mbar (1 bar) en passant à travers le clapet en position d'ouverture totale.

**PROVE
E CERTIFICAZIONI**

**TESTS AND COMPLIANCE
CERTIFICATIONS**

**ESSAIS ET
CERTIFICATIONS**

**DIAGRAMMA DELLE PERDITE DI CARICO
PER VALVOLE DI FONDO**

FOOT VALVES PRESSURE LOSS DIAGRAM

**DIAGRAMME DES PERTES DE CHARGE
POUR CLAPETS DE PIED**



ISTITUTO GIORDANO s.p.a.
CENTRO POLITECNICO DI RICERCHE

Via Rossini, 2
47041 BELLARIA (RN) Italy

Tel. ++ 39/(0) 541/343030 (9 linee)
Telefax ++ 39/(0) 541/345540

Cod. Fisc./Part. IVA: 00549540400
C.C.I.A.A. 156786
Iscri. Reg. Soc. n. 1852
Cap. Soc. L. 1.200.000.000 Iv.

RAPPORTO DI PROVA N. 107896

Luogo e data di emissione: Bellaria, 22/04/1997

Committente: BUCCHI S.r.l. - Via Bonsi, 57 - 48022 LUGO (RA)

Data della richiesta della prova: 14/03/1997

Numero e data della commessa: 7185,24/03/1997

Data del ricevimento del campione: 21/03/1997

Data dell'esecuzione della prova: dal 31/03/1997 al 01/04/1997

Oggetto della prova: Rilievo della caratteristica idraulica di portata-perdita di carico su valvole di fondo in resina acetica (POM).

Luogo della prova: Istituto Giordano S.p.A. - Sezione 1 - Via Rossini, 2 - Bellaria (RN).

Provenienza del campione: dal Committente.

Identificazione del campione in accettazione: n.97/139a.

Denominazione del campione*:

Il campione sottoposto a prova è denominato "Valvola di fondo in resina acetica."



(*) secondo le dichiarazioni del Committente.

Comp. PM
Rev. 01

Il presente rapporto di prova è composto da n. 5 fogli.

Foglio
n. 1 di 5





DIAGRAMMA DELLE PERDITE DI CARICO PER VALVOLE DI RITEGNO

CHECK VALVES PRESSURE LOSS DIAGRAM

DIAGRAMME DES PERTES DE CHARGE POUR CLAPETS DE RETENUE

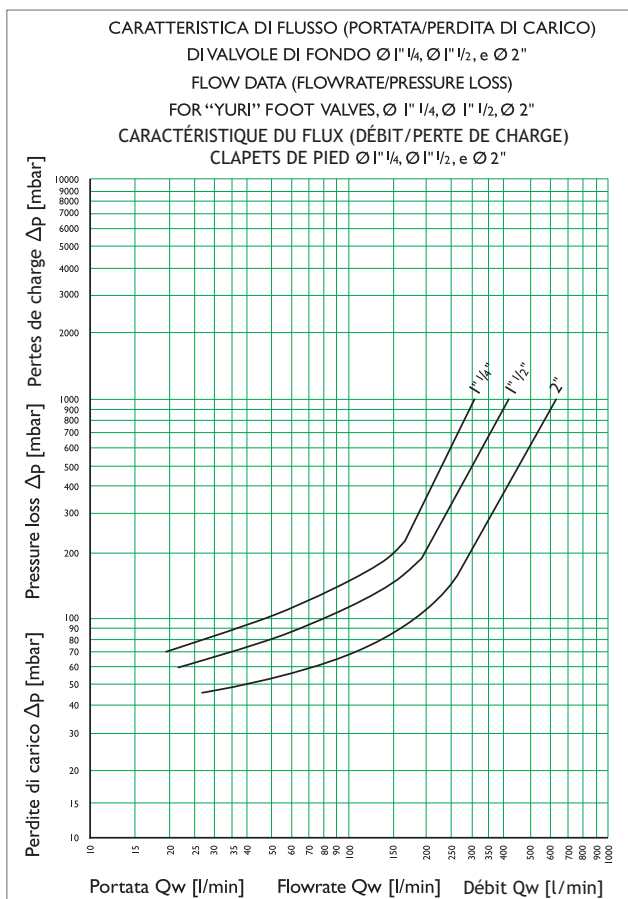

ISTITUTO GIORDANO

CENTRO POLITECNICO DI RICERCHE s.p.a.

Via Rossini, 2 47041 BELLARIA (RN) Italy Tel. ++ 39 (0) 541 / 343200 (9 linee) Fax ++ 39 (0) 541 / 345540 Cod. Fisc./Part. IVA: 00549540409 C.C.I.A.A. 1561705 Iscr. Reg. Soc. n. 18522 Cap. Soc. L. 1.200.000.000 i.v.

RAPPORTO DI PROVA N. 107897

Luogo e data di emissione: Bellaria, 22/04/1997

Committente: BUCCHI S.r.l. - Via Bonsi, 57 - 48022 LUGO (RA)

Data della richiesta della prova: 14/03/1997

Numero e data della commessa: 7185,24/03/1997

Data del ricevimento del campione: 21/03/1997

Data dell'esecuzione della prova: dal 28/03/1997 al 01/04/1997

Oggetto della prova: Rilievo della caratteristica idraulica di portata-perdita di carico su valvole di ritegno in resina acetilica (POM).

Luogo della prova: Istituto Giordano S.p.A. - Sezione 1 - Via Rossini, 2 - Bellaria (RN).

Provenienza del campione: dal Committente.

Identificazione del campione in accettazione: n.97/139b.

Denominazione del campione*.

Il campione sottoposto a prova è denominato "Valvola di ritegno in resina acetilica modello YURI."



(*) secondo le dichiarazioni del Committente.

Comp. PM

Revis.

Il presente rapporto di prova è composto da n. 5 fogli.

Foglio n. 1 di 5

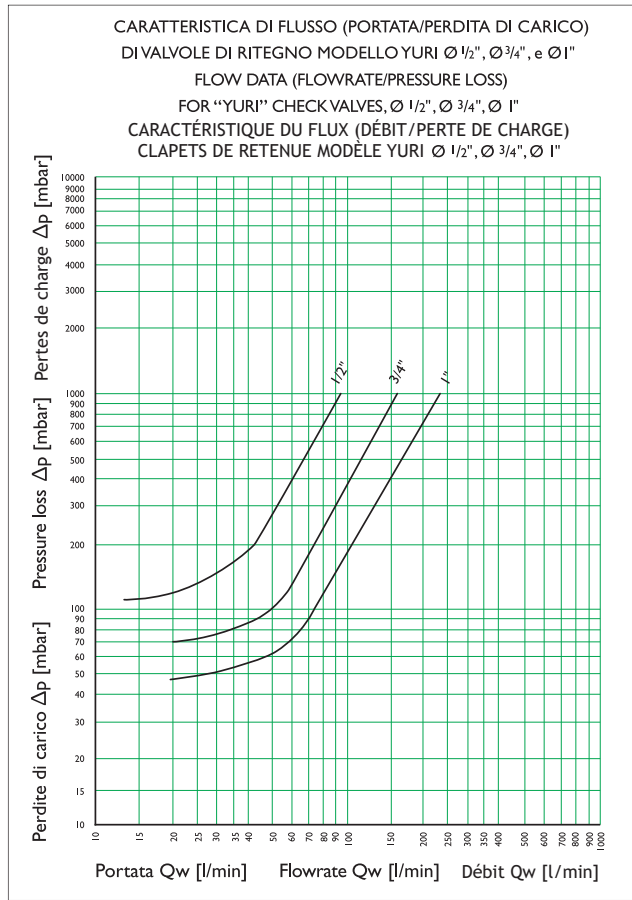

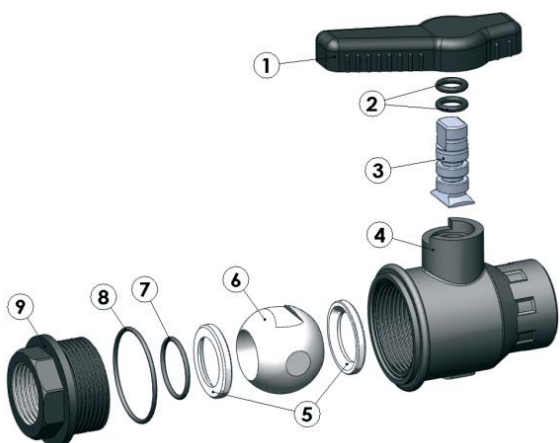
Portata Qw [l/min]
Flowrate Qw [l/min]
Débit Qw [l/min]

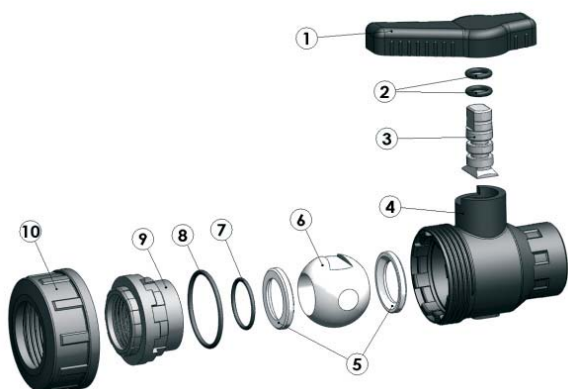

	Componenti	Components	Composants
1	Maniglia	Handle	Manette
2	Guarnizione O-ring perno	Pin O-ring gasket	Joint torique axe
3	Perno	Pin	Axe
4	Corpo	Body	Corps
5	Guarnizione in PTFE	PTFE gasket	Joint en PTFE
6	Sfera	Ball	Bille
7	Guarnizione (O-ring) di supporto della guarnizione 5	(O-ring) gasket supporting gasket 5	Joint (torique) de support pour le joint 5
8	Guarnizione (O-ring) di tenuta radiale	Radial sealing (O-ring) gasket	Joint (torique) radial
9	Bussola	Bush	Douille

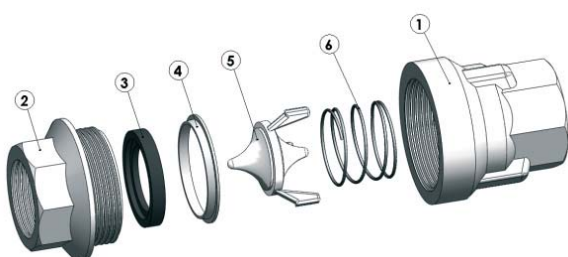

	Componenti	Components	Composants
1	Maniglia	Handle	Manette
2	Guarnizione O-ring perno	Pin O-ring gasket	Joint torique axe
3	Perno	Pin	Axe
4	Corpo	Body	Corps
5	Guarnizione in PTFE	PTFE gasket	Joint en PTFE
6	Sfera	Ball	Bille
7	Guarnizione (O-ring) di supporto della guarnizione 5	(O-ring) gasket supporting gasket 5	Joint (torique) de support pour le joint 5
8	Guarnizione (O-ring) di tenuta radiale	Radial sealing (O-ring) gasket	Joint (torique) radial
9	Bussola	Bush	Douille
10	Ghiera	Ring nut	Écrou



	Componenti	Components	Composants
1	Corpo	Body	Corps
2	Bussola	Bush	Douille
3	Guarnizione	Gasket	Joint
4	Anello	Ring	Anneau
5	Otturatore	Obturator	Obturateur
6	Molla	Spring	Ressort

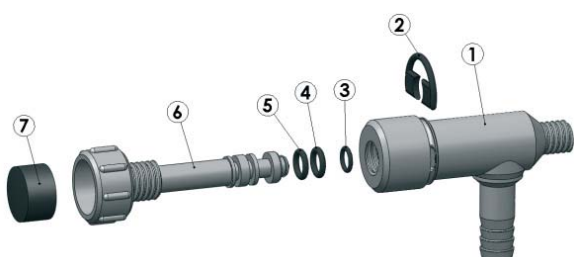

	Componenti	Components	Composants
1	Corpo	Body	Corps
2	Forchetta	Fork	Fourchette
3	Guarnizione (O-ring) di tenuta radiale	Radial sealing (O-ring) gasket	Joint (torique) radial
4-5	Guarnizione O-ring	O-ring gasket	Joint torique
6	Pomello	Grip	Bouton
7	Tappo	Cap	Bouchon

Standard di connessione

Connection standards

Standards de connexion

Linea Line Ligne	Giunzioni	Joints	Jonction
2-8-4-7000	Valvole: a sfera, a cilindro, di ritegno e di fondo, Rubinetti attacchi filettati, secondo le seguenti norme: <ul style="list-style-type: none"> • con filettatura interna: gas cilindrico UNI ISO 228/1 • con filettatura esterna: gas cilindrico UNI ISO 228/1 	Valves: ball, cylinder, check and foot valves, Cocks threaded couplings, in compliance with the following standards: <ul style="list-style-type: none"> • with internal thread: BSP parallel threading, UNI ISO 228/1 • with external thread: BSP parallel threading, UNI ISO 228/1 	Vannes : à bille, cylindriques, de retenue et de pied, Robinets raccords filetés, selon les normes suivantes : <ul style="list-style-type: none"> • avec filet intérieur : gaz cylindrique UNI ISO 228/1 • avec filet extérieur : gaz cylindrique UNI ISO 228/1
3000	Valvole a sfera attacchi conici <ul style="list-style-type: none"> • con sede conica interna 	Ball valves taper couplings <ul style="list-style-type: none"> • with internal taper seat 	Vannes à bille connexions coniques <ul style="list-style-type: none"> • avec siège conique interne

Tenuta idraulica

Hydraulic tightness

Étanchéité hydraulique

Linea Line Ligne	Su giunzioni e raccomandazioni	For gaskets and recommendations	Pour joints et recommandations
2-8-4-7000	Valvole: a sfera, di ritegno, di fondo, Rubinetti <ul style="list-style-type: none"> • estremità con filettatura esterna-interna: mediante interposizione di nastro PTFE o prodotti sigillanti 	Valves: ball, cylinder, and foot valves, Cocks <ul style="list-style-type: none"> • end with external/internal thread: by interposing PTFE tape or sealant 	Vannes : à bille, de retenue, de pied, Robinets <ul style="list-style-type: none"> • extrémité avec filet extérieur-intérieur : application de ruban en PTFE ou produits scellants
4000	Valvole a cilindro <ul style="list-style-type: none"> • estremità con filettatura filettatura interna ghiera mobile: con guarnizione piana • estremità con attacco passaparete: con guarnizione piana 	Cylinder valves <ul style="list-style-type: none"> • end with internal thread mobile ring nut: with flat gasket • end with passwall connector: with flat gasket 	Vannes cilindriche <ul style="list-style-type: none"> • extrémité avec filet intérieur écrou mobile : avec joint plat • extrémité avec raccord passe-paroi : avec joint plat
3000	Valvole a sfera <ul style="list-style-type: none"> • estremità con attacco passaparete: con guarnizione piana • estremità con filettatura interna: mediante interposizione di nastro PTFE o prodotti sigillanti • estremità con sede conica: accoppiamento conico 	Ball valves <ul style="list-style-type: none"> • end with passwall connector: with flat gasket • end with internal thread: by interposing PTFE tape or sealant • end with taper seat: taper coupling 	Vannes à bille <ul style="list-style-type: none"> • extrémité avec raccord passe-paroi : avec joint plat • extrémité avec filet intérieur : application de ruban en PTFE ou produits scellants • extrémité avec siège conique : jonction conique

ISTRUZIONI PER L'INSTALLAZIONE

INSTRUCTIONS FOR INSTALLATION

INSTRUCTIONS POUR L'INSTALLATION

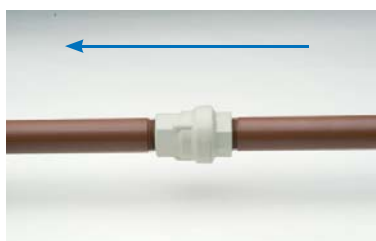
**Mandata**

Collegare la valvola al tubo facendo attenzione al riferimento della freccia.

Delivery

Connect the valve to the pipe paying attention to the direction of the arrow.

Refoulement

Brancher la vanne sur le tuyau, en faisant attention à la direction de la flèche.

Aspirazione

Collegare la valvola alla pompa facendo attenzione al riferimento della freccia.

Suction

Connect the valve to the pump paying attention to the direction of the arrow.

Aspiration

Brancher la vanne sur la pompe, en faisant attention à la direction de la flèche.

Gli accessori

Accessories

Accessories

L'UTILIZZO DI PRODOTTI SIGILLANTI

Come per i raccordi filettati, vedi pag. 20

USE OF SELANTS

As per threaded fittings, see page 20

UTILISATION DE PRODUITS SCELLANTS

Comme pour les raccords filetés, voir page 20

RACCORDI PORTAGOMMA con accoppiamento conico e filettatura mista GAS e profilo metrico, in poliammide 66 (PA) - (nylon) per tubi flessibili

Polyamide PA 66 (PA) - (nylon) HOSE NOZZLES with taper connections and mixed metric profile GAS threading for flexible hose
EMBOUITS CANNELÉS avec jonction conique et filetage mixte pas du GAZ et profil métrique, en polyamide 66 (PA) - (nylon) pour tuyaux flexibles

0200044

RACCORDO TRE PEZZI DIRITTO

con accoppiamento conico
estremità maschio filettata G1
estremità portagomma per tubo DN

STRAIGHT THREE-PIECE FITTING

with taper connection
with male threaded end G1
with hose nozzle end for DN hoses

RACCORD DROIT TROIS PIÈCES

avec jonction conique
extrémité mâle filetée G1
extrémité embout
cannelé pour tuyau
DN

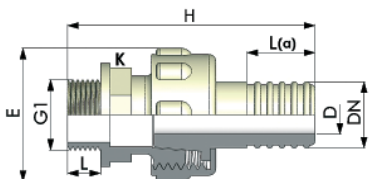

*** NEW**

codice / code / code	G1	DN mm(inch)	D	H	L(a)	E	L	K	
0200044.000516	3/4"	16 (5/8")	11	83	23	40	12	27	
0200044.000520	3/4"	20 (25/32")	15	81	24	40	12	27	
0200044.000720	1"	20 (25/32")	15	81	24	40	12	27	
0200044.000722	1"	22 (7/8")	17	88	24	49	12	32	
0200044.000725	1"	25 (1")	19	89	25	49	12	32	
0200044.000730	1"	30 (1 1/16)	23,5	97	28	55	12	32	
0200044.000732	1"	32 (1 1/4)	24	95	28	55	12	32	
0200044.000735	1"	35 (1 1/8)	28,5	110	35	59	15,5	38	
0200044.000740	1"	40 (1 9/16)	33	112	35	64	15,5	45	
0200044.000930	1 1/4	30 (1 3/16)	23,5	104	28	55	15	36	
0200044.000932	1 1/4	32 (1 1/4)	24	103	28	55	15	36	
0200044.000935	1 1/4	35 (1 3/8)	28,5	112	35	59	15	38	
0200044.000940	1 1/4	40 (1 9/16)	33	115	35	64	15	45	
0200044.000950	1 1/4	50 (2")	42,5	125	42	83	15	45	
0200044.001135	1 1/2	35 (1 3/8)	28,5	111	35	59	15,5	38	
0200044.001138	1 1/2	38 (1 1/2)	31	116	43,5	64	15,5	46	
0200044.001140	1 1/2	40 (1 9/16)	33	112	35	64	15,5	46	
0200044.001150	1 1/2	50 (2")	42,5	125	42	83	15,5	45	
0200044.001550	2"	50 (2")	42,5	133	42,5	83	15,5	56	
0200044.001560	2"	60 (2 3/8)	51	146	65	89	16,5	56	

0200046

RACCORDO TRE PEZZI CURVO a 90°

con accoppiamento conico
estremità maschio filettata G1
estremità portagomma per tubo DN

90° THREE-PIECE ELBOW FITTING

with taper connection - with a male threaded end G1
with hose nozzle end for DN hoses

RACCORD COUDÉ À 90° TROIS PIÈCES

avec jonction conique
extrémité mâle filetée G1
extrémité embout cannelé
pour tuyau DN

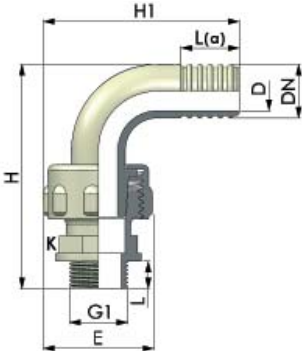

*** NEW**

codice / code / code	G1	DN mm(inch)	D	H	H1	L(a)	E	L	K
0200046.000520	3/4"	20 (25/32")	15	84	76	33	40	12	27
0200046.000720	1"	20 (25/32")	15	84	76	33	40	12	27
0200046.000722	1"	22 (7/8")	17	92	87	30	40	12	32
0200046.000725	1"	25 (1")	19,5	94	87	30	49	12	32
0200046.000730	1"	30 (1 1/16)	24,5	102	97	28	55	12	32
0200046.000732	1"	32 (1 1/4)	24,5	103	97	31	55	12	32
0200046.000735	1"	35 (1 1/8)	28,5	113	102	35	59	15,5	38
0200046.000740	1"	40 (1 9/16)	33	126	108	36	64	15,5	45
0200046.000930	1 1/4	30 (1 3/16)	24,5	97	111	28	55	15	36
0200046.000932	1 1/4	32 (1 1/4)	24,5	112	97	31	55	15	36
0200046.000935	1 1/4	35 (1 3/8)	28,5	114	102	35	59	15	38
0200046.000940	1 1/4	40 (1 9/16)	33	126	108	36	64	15	45
0200046.000950	1 1/4	50 (2")	42	139	128	35	83	15	45
0200046.001135	1 1/2	35 (1 3/8)	28,5	113	102	35	59	15,5	38
0200046.001138	1 1/2	38 (1 1/2)	33	126	108	36	64	15,5	46
0200046.001140	1 1/2	40 (1 9/16)	33	126	108	36	64	15,5	46
0200046.001150	1 1/2	50 (2")	42	139	128	35	83	15,5	45
0200046.001550	2"	50 (2")	42	147	128	35	83	16,5	56

0200030

NIPPLO DI PASSAGGIO

estremità femmina con accoppiamento conico filettata
maschio profilo metrico M
estremità maschio filettata G1

ADAPTER NIPPLE

Threaded female end with taper connection M metric
threaded male end - male threaded end G1

MAMELON DE PASSAGE

extrémité femelle filetée avec jonction conique
mâle profil métrique M
extrémité mâle filetée G1

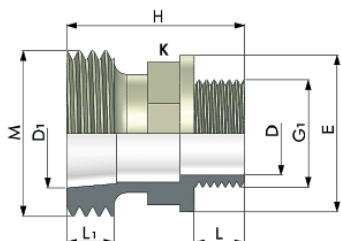

codice / code / code	G1	D1	M	D	H	E	L	L1	K
0200030.000520	3/4"	20	M29x1,75	19,5	34,5	30,5	12	8	27
0200030.000720	1"	20	M29x1,75	19	34	35	12	8	27
0200030.000725	1"	25	M36x3	24,5	42,5	41	12	14	32
0200030.000730	1"	30	M42x3	24,5	42,5	41	12	14	32
0200030.000735	1"	35	M45x3	24,5	51	45	15,5	15	38
0200030.000740	1"	40	M52x3	24,5	51	51	15,5	14,5	45
0200030.000930	1 1/4	30	M42x3	24,5	50,5	48,5	15	14	36
0200030.000935	1 1/4	35	M45x3	32	51,5	48,5	15	14,5	38
0200030.000940	1 1/4	40	M52x3	32	52	51	15	15	45
0200030.000950	1 1/4	50	M66x3	32	53,5	51	15	17	45
0200030.001135	1 1/2	35	M45x3	32	52	53	15,5	15	38
0200030.001140	1 1/2	40	M52x3	38	52,5	53	15,5	15	45
0200030.001150	1 1/2	50	M66x3	38	54	53	15,5	17	45
0200030.001550	2"	50	M66x3	48,5	61	66	16,5	16	56
0200030.001560	2"	60	M72x4	48,5	65	66	16,5	19,5	56

0200042

PORTAGOMMA TRE PEZZI DIRITTO

con accoppiamento conico per tubo DN

STRAIGHT THREE-PIECE HOSE NOZZLE

with taper connection for DN hoses

EMBOUIT CANNELÉ DROIT TROIS PIÈCES

avec jonction conique pour tuyau DN

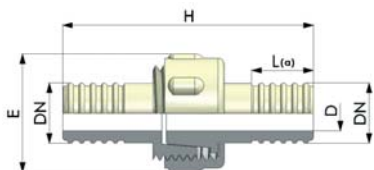

codice / code / code	DN mm(inch)	D	H	L(a)	E
0200042.001313	13 (1/2")	8	84	21	27,5
0200042.001616	16 (5/8")	11	100	24	40
0200042.002020	20 (25/32")	15	97	24	40
0200042.002222	22 (7/8")	17	100	24	49
0200042.002525	25 (1")	19	101	25	49
0200042.003030	30 (1"3/16)	23,5	114	28	55
0200042.003232	32 (1"1/4)	24	112	28	55
0200042.003535	35 (1"3/8)	28,5	126	35	59
0200042.004040	40 (1"9/16)	33	129	35	64
0200042.005050	50 (2")	42,5	156	42	83
0200042.006060	60 (2"3/8)	51	176	62	89

0200040

PORTAGOMMA CURVO a 90°

per tubo DN

estremità maschio con accoppiamento conico

e ghiera mobile filettata M

90° ELBOW - with hose nozzle

for DN hoses

male end with taper connection and M threaded movable ring nut

EMBOUIT CANNELÉ DROIT

DROIT

pour tuyau DN

extrémité mâle avec

jonction conique et écrou

mobile fileté M

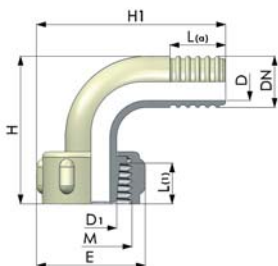

codice / code / code	DN mm(inch)	D1	M	D	H	H1	L(a)	E	L(1)
0200040.002020	20 (25/32")	20	M29x1,75	15	55	79	33	40	8,5
0200040.002522	22 (7/8")	25	M36x3	17	61	87	30	49	12,5
0200040.002525	25 (1")	25	M36x3	19,5	61	87	30	49	13,5
0200040.003030	30 (1"3/16)	30	M42x3	24,5	70	97	28	55	14
0200040.003032	32 (1"1/4)	30	M42x3	24,5	73	97	31	55	14
0200040.003535	35 (1"3/8)	35	M45x3	28,5	74	74	35	59	15
0200040.003838	38 (1"1/2)	38	M52x3	33	86	108	36	64	16
0200040.004040	40 (1"9/16)	40	M52x3	33	86	108	36	64	16
0200040.005050	50 (2")	50	M66x3	42	95	128	35	83	16,5

0200010

PORTAGOMMA DIRITTO

per tubo DN

estremità maschio con accoppiamento conico e ghiera mobile

filettata M

STRAIGHT FITTING - with hose nozzle

for DN hoses

male end with taper connection and M threaded movable ring nut

EMBOUIT CANNELÉ DROIT

pour tuyau DN

extrémité mâle avec

jonction conique et écrou

fileté

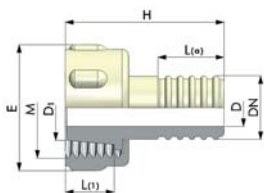

NEW

codice / code / code	DN mm(inch)	D1	M	D	H	L(a)	E	L(1)
0200010.002020	20 (25/32")	20	M29x1,75	15	52	24	40	8,5
0200010.002522	22 (7/8")	25	M36x3	17	57	24	49	8,5
0200010.002525	25 (1")	25	M36x3	19	57	25	49	12,5
0200010.003030	30 (1"3/16)	30	M42x3	23,5	64	28	55	14
0200010.003032	32 (1"1/4)	30	M42x3	24	64	28	55	14
0200010.003535	35 (1"3/8)	35	M45x3	28,5	71	35	59	14,5
0200010.003838	38 (1"1/2)	38	M52x3	31	80	43,5	64	16
0200010.004040	40 (1"9/16)	40	M52x3	33	73	35	64	16
0200010.005050	50 (2")	50	M66x3	42,5	82	42	83	17
0200010.006060	60 (2"3/8)	60	M72x4	51	93	65	89	17,5

0200020

PORTAGOMMA DIRITTO

per tubo DN

estremità femmina con accoppiamento conico filettata maschio

profilo metrico M

STRAIGHT FITTING - with hose nozzle

for DN hoses

threaded female end with taper connection M metric threaded male end

EMBOUIT CANNELÉ DROIT

pour tuyau DN

extrémité femelle avec

jonction conique fileté mâle

profil métrique M

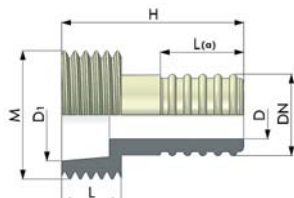

codice / code / code	DN mm(inch)	D1	M	D	H	L(a)	L
0200020.002020	20 (25/32")	20	M29x1,75	15	50	24	9
0200020.002525	25 (1")	25	M36x3	19	53	25	13
0200020.003030	30 (1"3/16)	30	M42x3	23,5	61	28	14
0200020.003535	35 (1"3/8)	35	M45x3	28,5	68	35	14,5
0200020.004040	40 (1"9/16)	40	M52x3	33,5	67,5	35	14
0200020.005050	50 (2")	42	M66x3	42	86,5	42	16
0200020.006060	60 (2"3/8)	60	M72x4	53	96,5	65	19

RACCORDI PORTAGOMMA con filettatura GAS, in poliammide 66 (PA) - (nylon) per tubi flessibili

Polyamide 66 (PA) - (nylon) HOSE NOZZLES with GAS thread for flexible hose

EMBOUS CANNELÉS avec filetage pas du GAZ, en polyamide 66 (PA) - (nylon) pour tuyaux flexibles

0200130**PORTAGOMMA DIRITTO**

per tubo DN

estremità maschio filettata G1

STRAIGHT HOSE NOZZLE

for DN hose

with male threaded end G1

EMBOUS CANNELÉ**DROIT**

pour tuyau DN

extrémité mâle filetée G1



Figura 1

estremità maschio filettata G1 (L a norma ISO 7/1)
con sede O-ring

with male thread end G1 (L as per ISO 7/1)

with place to fit O-ring

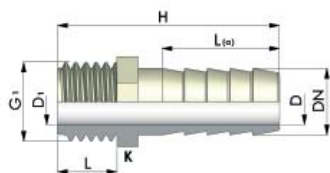
extrémité mâle filetée G1 (L selon la norme ISO 7/1)

avec siège joint torique

NEW

Figura 2

* disponibile nel 2011

* available in 2011

* disponible en 2011

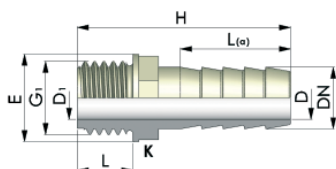
*** attualmente senza sede OR

*** no place to fit O-ring

*** actuellement sans siège joint torique

codice / code / code	G1	DN mm(inch)	D	D1	H	L(a)	L	K
0200130.000107	1/4"	7 (5/16")	4	7	39,5	17	12	15
0200130.000112	1/4"	12 (15/32)	7,5	8	48	27	12	15
0200130.000207	3/8"	7 (5/16")	4	10	41,5	17	13,5	20
0200130.000210	3/8"	10 (3/8")	6	10	47	22	13,5	20

codice / code / code	G1	DN mm(inch)	D	D1	H	L(a)	E	L	K
*** 0200130.000212	3/8"	12 (15/32")	7,5	10	51,5	25	23	11	20
*** 0200130.000216	3/8"	16 (5/8")	10	10,5	58,5	30	23	10,5	20
** 0200130.000310	1/2"	10 (3/8")	6	14	52,5	22,5	28	13	22
0200130.000313	1/2"	13 (1/2")	8	14	55,5	26	28	14,5	22
** 0200130.000315	1/2"	15 (19/32)	10	14	58	26	28	14,5	22
0200130.000316	1/2"	16 (5/8")	10	14	64,5	26	28	14,5	22
0200130.000320	1/2"	20 (25/32")	10	14	64	26	28	14,5	22
* 0200130.000325	1/2"	25 (1")	13,5	14,5	68,5	37	28	14,5	21
*** 0200130.000510	3/4"	10 (3/8")	6	19	50,5	22	31	14,5	19
*** 0200130.000512	3/4"	12 (15/32")	7,5	19	56	27	31	14,5	19
0200130.000513	3/4"	13 (1/2")	8	18	58,5	26	33	16	27
0200130.000516	3/4"	16 (5/8")	10	14	67	26	33	16	27
0200130.000520	3/4"	20 (25/32")	13	18	65	31	33	16	27
0200130.000525	3/4"	25 (1")	19	19	73,5	37	33	16	27
0200130.000720	1"	20 (25/32")	13	22,5	70	30	41,5	18,5	36
*** 0200130.000722	1"	22 (7/8")	17	24	69,5	37	38,5	14,5	30
0200130.000725	1"	25 (1")	19	22,5	75,5	36	41,5	18,5	36
0200130.000730	1"	30 (1"3/16)	22,5	23	79,5	36	41,5	18,5	36
0200130.000732	1"	32 (1"1/4)	22,5	23	79,5	36	41,5	18,5	36
0200130.000920	1"1/4	20 (25/32")	13	32,5	72,5	30	47,5	21	41
0200130.000925	1"1/4	25 (1")	19,5	32,5	75	37	47,5	21	41
0200130.000930	1"1/4	30 (1"3/16)	24,5	32,5	81	43	47,5	21	41
0200130.000932	1"1/4	32 (1"1/4)	25,5	32,5	81	43	47,5	21	41
0200130.000935	1"1/4	35 (1"3/8)	29	32,5	81	43	47,5	21	41
* 0200130.000938	1"1/4	38 (1"1/2)	31	32,5	83	43,5	47,5	21	41
0200130.000940	1"1/4	40 (1"9/16)	32	32,5	83	43,5	47,5	21	41
0200130.001138	1"1/2	38 (1"1/2)	31	38,5	83	43,5	54,5	21	50
0200130.001140	1"1/2	40 (1"9/16)	33	38,5	83	43,5	54,5	21	50
0200130.001150	1"1/2	50 (2")	42	38,5	84,5	44	54,5	21	50
0200130.001550	2"	50 (2")	42	48,5	88,5	44	65	25	60
0200130.001560	2"	60 (2"3/8)	51,5	48,5	91	46,5	65	25	60

0200138**PORTAGOMMA DIRITTO (0200130)**

con O-ring in NBR

STRAIGHT HOSE NOZZLE (0200130)

with NBR O-ring

EMBOUS CANNELÉ DROIT (0200130)

avec joint torique en NBR

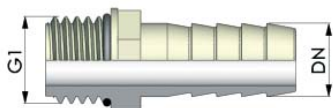

codice / code / code	G1	DN mm(inch)
0200138.000313	1/2"	13 (1/2")
0200138.000315	1/2"	15 (19/32")
0200138.000316	1/2"	16 (5/8")
0200138.000320	1/2"	20 (25/32")
0200138.000325	1/2"	25 (1")
0200138.000513	3/4"	13 (1/2")
0200138.000516	3/4"	16 (5/8")
0200138.000520	3/4"	20 (25/32")
0200138.000525	3/4"	25 (1")
0200138.000720	1"	20 (25/32")
0200138.000725	1"	25 (1")
0200138.000730	1"	30 (1"3/16)
0200138.000732	1"	32 (1"1/4)
0200138.000920	1"1/4	20 (25/32")
0200138.000925	1"1/4	25 (1")
0200138.000930	1"1/4	30 (1"3/16)
0200138.000932	1"1/4	32 (1"1/4)
0200138.000935	1"1/4	35 (1"3/8)
0200138.000938	1"1/4	38 (1"1/2)
0200138.000940	1"1/4	40 (1"9/16)
0200138.001138	1"1/2	38 (1"1/2)
0200138.001140	1"1/2	40 (1"9/16)
0200138.001150	1"1/2	50 (2")
0200138.001550	2"	50 (2")
0200138.001560	2"	60 (2"3/8)

O-ring

in NBR per i prodotti con i codici:

O-ring

made of NBR for products with the codes:

Joint torique

en NBR pour les produits avec les codes :

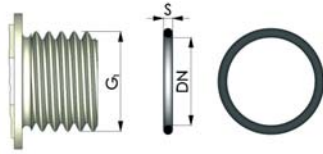

0200130

codice / code / code	G1	DN	S
8050123.14	1/2"	17,96	2,62
8053093.14	3/4"	23,47	2,62
8053118.14	1"	29,8	2,62
8054150.14	1"1/4	37,69	3,53
8054175.14	1"1/2	44,04	3,53
8050159.14	2"	55,56	3,53

Su richiesta viene fornito in EPDM
EPDM upon request
Fourni en EPDM à la demande

0200131

PORTAGOMMA CURVO a 90°

per tubo DN
estremità maschio filettata G1

90° ELBOW HOSE NOZZLE

for DN hose
with male threaded end G1

EMBOU CANNÉ

COUDÉ à 90°

pour tuyau DN
extrémité mâle filetée G1

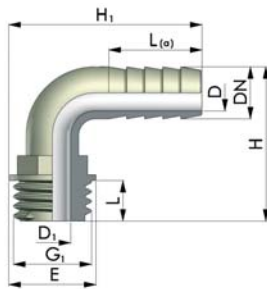

NEW

estremità maschio filettata G1 (L a norma ISO 7/1)

male thread end G1 (L as per ISO 7/1)

extrémité mâle filetée G1 (L selon la norme ISO 7/1)

mod. GOMITO a 90°

estremità maschio filettata G1

mod. 90° ELBOW

with male threaded end G1

mod. COUDE à 90°

extrémité mâle filetée G1

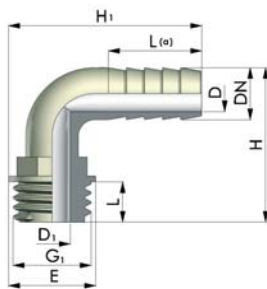

estremità maschio filettata G1 (L a norma ISO 7/1)

male thread end G1 (L as per ISO 7/1)

extrémité mâle filetée G1 (L selon la norme ISO 7/1)

codice / code / code	G1	DN mm(inch)	D	D1	H	H1	L(a)	E	L
0200131.000725	1"	25 (1")	19,5	21	66	81	30	39	14
0200131.000930	1"1/4	30 (1"3/16)	25,5	32,5	73	91	28	47	15,5
0200131.000932	1"1/4	32 (1"1/4)	24,5	32,5	74	91	32	47	15,5
0200131.001138	1"1/2	38 (1"1/2)	33	38,5	85	102	35	53,5	15
0200131.001140	1"1/2	40 (1"9/16)	33	38,5	85	102	35	53,5	15

0200131.000525	3/4"	25 (1")	19,5	19	64	78	30	30,5	14,5
0200131.000730	1"	30 (1"3/16)	24,5	24,5	68	87	28	39	14,5
0200131.000732	1"	32 (1"1/4)	24,5	24,5	69	87	32	39	14,5
0200131.001550	2"	50 (2")	42	48	111	120	32	70	22

0200131.000212	3/8"	12 (15/32")	7	10	43	55	30	21	12
----------------	------	-------------	---	----	----	----	----	----	----

0200131.000312	1/2"	12 (15/32")	7	14	44	57	30	25	13,5
0200131.000316	1/2"	16 (5/8")	11	14	47	57	30	25	13,5
0200131.000320	1/2"	20 (25/32")	15	15,5	61	70	33	25	13,5
0200131.000512	3/4"	12 (15/32")	7	19	45	60	30	31	14,5
0200131.000520	3/4"	20 (25/32")	15	19	64	72	33	30,5	14,5
0200131.000522	3/4"	22 (7/8")	17	20	62	78	30	30,5	14,5
0200131.000722	1"	22 (7/8")	17	21	65	80	30	39	14,5

0200120

PORTAGOMMA DIRITTO

per tubo DN
estremità femmina ghiera mobile filettata G con guarnizione
piana in EPDM

STRAIGHT HOSE NOZZLE

for DN hoses
with female threaded end for movable ring nut G and
EPDM flat gasket

EMBOU CANNELÉ DROIT

pour tuyau DN
extrémité femelle écrou
mobile fileté G avec joint
plat en EPDM

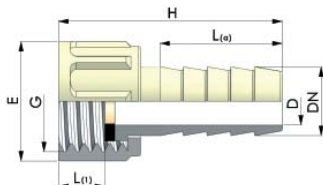

NEW

* disponibile nel 2011
* available in 2011
* disponible en 2011

codice / code / code	G	DN mm(inch)	D	H	L(a)	E	L(1)
0200120.000107	1/4"	7 (5/16")	4	38	17	20	8,5
0200120.000209	3/8"	9 (11/32")	5	47	22	23	9,5
0200120.000210	3/8"	10 (3/8")	6	45	22	23	10
0200120.000212	3/8"	12 (5/32")	7,5	47,5	27	23	9,5
0200120.000310	1/2"	10 (3/8")	8	50	25	28	10
** 0200120.000312	1/2"	12 (15/32")	7	52	25	27,5	9,5
0200120.000313	1/2"	13 (1/2")	8,5	49	25	27,5	9,5
0200120.000316	1/2"	16 (5/8")	10	58,5	30,5	27,5	10
0200120.000510	3/4"	10 (3/8")	6	47	22	33	11,5
0200120.000512	3/4"	12 (15/32")	7,5	53,5	27	33	10,5
0200120.000513	3/4"	13 (1/2")	8,5	49,5	25	33	11,5
0200120.000516	3/4"	16 (5/8")	10	56,5	30,5	33	11
0200120.000519	3/4"	19 (3/4")	14,5	62,5	33	33	11
0200120.000520	3/4"	20 (25/32")	13	55,5	30,5	33	11
0200120.000720	1"	20 (25/32")	13	57	30,5	40,5	11,5
0200120.000722	1"	22 (7/8")	17,5	68,5	37	40,5	12
0200120.000725	1"	25 (1")	19	63,5	36	40,5	12
0200120.000925	1"1/4	25 (1")	19	63,5	36	51	11,5
0200120.000930	1"1/4	30 (1"3/16)	19	64,5	36	51	11,5
0200120.000932	1"1/4	32 (1"1/4)	23	64,5	36	51	11,5
* 0200120.001138	1"1/2	38 (1"1/2)	32	81	43	57	12
0200120.001140	1"1/2	40 (1"9/16)	33	82	43	57,5	12
0200120.001550	2"	50 (2")	42	84,5	44	71	12

0200121

PORTAGOMMA CURVO a 90°

per tubo DN
estremità femmina ghiera mobile filettata G con guarnizione
piana in EPDM

90° ELBOW HOSE NOZZLE

for DN hoses
with female threaded end for
movable ring nut G and EPDM
flat gasket

EMBOU CANNELÉ

COUDÉ à 90°

pour tuyau DN
extrémité femelle écrou mobile
fileté G avec joint plat en
EPDM

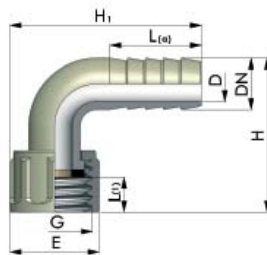

NEW

mod. GOMITO a 90°

mod. 90° ELBOW

mod. COUDE à 90°

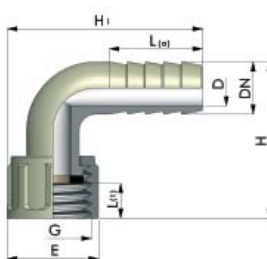

codice / code / code	G	DN mm(inch)	D	H	H1	L(a)	E	L(1)
0200121.000725	1"	25 (1")	19,5	61	82	30	40,5	10
0200121.000925	1"1/4	25 (1")	19,5	65	87	30	51	12
0200121.000930	1"1/4	30 (1"3/16)	24,5	72	94	28	51	12
* 0200121.000932	1"1/4	32 (1"1/4)	24	74	94	32	51	12
0200121.001138	1"1/2	38 (1"1/2)	33	90	106	35	57,5	11,5
0200121.001140	1"1/2	40 (1"9/16)	33	96	112	35	57,5	11,5
0200121.001550	2"	50 (2")	42,5	98	121	35	71	12,5
0200121.000312	1/2"	12 (15/32")	7	50	59	30	27,5	10,5
0200121.000512	3/4"	12 (15/32")	7	50	61	30	33	11,5
0200121.000516	3/4"	16 (5/8")	11	48	61	30	33	7
0200121.000520	3/4"	20 (25/32")	15,5	56	73	33	33	8
0200121.000722	1"	22 (7/8")	17	60	83	30	40,5	10

0200681

PORTAGOMMA GOMITO a 90°

per tubo DN
estremità femmina ghiera mobile filettata G con guarnizione
piana in EPDM

90° ELBOW HOSE NOZZLE

for DN hoses
with female threaded end for movable ring nut G
and EPDM flat gasket

EMBOU CANNELÉ COUDÉ à 90°

pour tuyau DN
extrémité femelle écrou mobile fileté G avec joint plat en EPDM

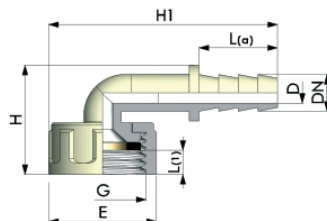

NEW

codice / code / code	G	DN mm(inch)	D	H	H1	L(a)	E	L(1)
0200681.000511	3/4"	11 (7/16")	7	32	70	22	33	8

0200136

PORTAGOMMA GOMITO a 90°

per tubo DN
estremità femmina per ghiera mobile filettata G
con sede con guarnizione piana

90° ELBOW HOSE NOZZLE

for DN hoses
with female threaded end for movable ring nut G with place
to fit a flat gasket

EMBOUIT CANNELÉ COUDÉ à 90°

pour tuyau DN
extrémité femelle pour
écrou mobile fileté G
avec siège avec joint plat

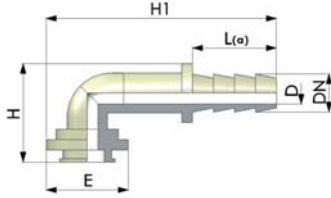

codice / code / code	G	DN mm (inch)	D	H	H1	L(a)	E
0200136.000511	3/4"	11(7/16")	7	27	65	22	23,5

Raccordo per lavatrice
Fitting for washing machines
Raccord pour lave-linge

Fornito a lotto minimo per quantità > a 25.000 pcs
Supplied as per minimum quantity > 25,000 pcs
Fourni avec quantité minimum > de 25.000 pcs

NEW

0200134

PORTAGOMMA DIRITTO

per tubo DN
estremità femmina per ghiera mobile filettata G con sede con
guarnizione piana

STRAIGHT HOSE NOZZLE

for DN hose
with female threaded end for movable ring nut G with place to fit
a flat gasket

EMBOUIT CANNELÉ DROIT

pour tuyau DN
extrémité femelle pour écrou mobile
fileté G avec siège avec joint plat

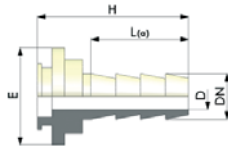

codice / code / code	G	DN mm(inch)	D	H	L(a)	E
0200134.000511	3/4"	11(7/16")	7	36,5	22	23,5

Raccordo per lavatrice
Fitting for washing machine
Raccord pour lave-linge

Fornito a lotto minimo per quantità > a 25.000 pcs
Supplied as per minimum quantity > 25,000 pcs
Fourni avec quantité minimum > de 25.000 pcs

NEW

200123

PORTAGOMMA DIRITTO

per tubo DN
estremità per ghiera mobile filettata G

STRAIGHT HOSE NOZZLE

for DN hoses
threaded end for movable ring nut G

EMBOUIT CANNELÉ DROIT

pour tuyau DN
extrémité pour écrou mobile fileté G

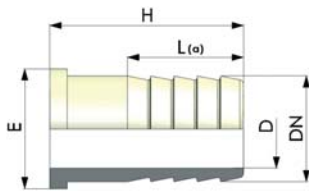

codice / code / code	G	DN mm(inch)	D	H	L(a)	E
0200123.000107	1/4"	7 (5/16")	4	28	17	11,5
0200123.000209	3/8"	9 (11/32")	5	36	22	15
0200123.000210	3/8"	10 (3/8")	6	33	22	15
0200123.000212	3/8"	12 (15/32")	7,5	36	27	15
0200123.000310	1/2"	10 (3/8")	6	33,5	22	18,5
** 0200123.000312	1/2"	12 (15/32")	7	36,5	25	18,5
0200123.000313	1/2"	13 (1/2")	8,5	38	25	18,5
0200123.000316	1/2"	16 (5/8")	10	46,5	30,5	18,5
0200123.000510	3/4"	10 (3/8")	6	33,5	22	24
0200123.000512	3/4"	12 (15/32")	7,5	40,5	27	24
0200123.000513	3/4"	13 (1/2")	8,5	35	25	24
0200123.000516	3/4"	16 (5/8")	10	44	30,5	24
0200123.000519	3/4"	19 (3/4")	14,5	50	33	24
0200123.000520	3/4"	20 (25/32")	13	43,5	30,5	24
0200123.000720	1"	20 (25/32")	13	43,5	30,5	30
0200123.000722	1"	22 (7/8")	17,5	55	37	30
0200123.000725	1"	25 (1")	19	49	36	30
0200123.000925	1"1/4	25 (1")	19	49	36	38,5
0200123.000930	1"1/4	30 (1"3/16)	23	49,5	36	38,5
0200123.000932	1"1/4	32 (1"1/4)	23	49,5	36	38,5
* 0200123.001138	1"1/2	38 (1"1/2)	32	66	43,5	44,5
0200123.001140	1"1/2	40 (1"9/16)	33	67	43,5	44,5
0200123.001550	2"	50 (2")	42	70	44	56,5

NEW

* disponibile nel 2011
* available in 2011
* disponible en 2011

0200124

PORTAGOMMA CURVO a 90°

per tubo DN
estremità per ghiera mobile filettata G

90° ELBOW HOSE NOZZLE

for DN hoses
threaded end for
movable ring nut G

EMBOUT CANNÉLÉ

COUDÉ À 90°
pour tuyau DN
extrémité pour écrou
mobile fileté G

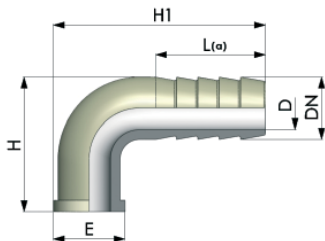

NEW

mod. GOMITO a 90°

mod. 90° ELBOW

mod. COUDE à 90°

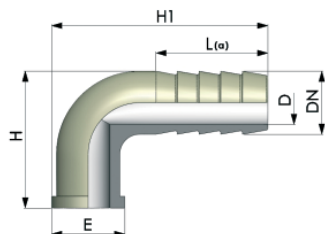

codice / code / code	G	DN mm(inch)	D	H	H1	L(a)	E
0200124.000725	1"	25 (1")	19,5	49	76	30	30,5
0200124.000925	1 1/4"	25 (1")	19,5	50	80	30	38,5
0200124.000930	1 1/4"	30 (1 3/16)	24,5	58	87	28	38,5
0200124.000932	1 1/4"	32 (1 1/4)	24	58	87	32	38
0200124.001138	1 1/2"	38 (1 1/2)	33	81	95	35	40
0200124.001140	1 1/2"	40 (1 9/16)	33	81	95	35	40
0200124.001550	2"	50 (2")	42,5	82	112	35	56

0200122

GHIERA

con filettatura G per i prodotti con i codici e DN:

RING NUT

thread G for products with the codes
and DN:

ÉCROU

avec filet G pour les produits avec les
codes et DN :

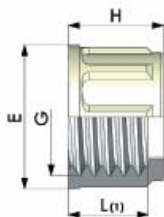

0200120, 0200121, 0200650, 0200685,
0200651

con i codici e DN:

with the codes and DN:

avec les codes et DN :

0200121.000516, 0200121.000520, 0200121.000725

con i codici e DN:

with the codes and DN:

avec les codes et DN :

0200136.000511, 0200134.000511,
0200681.000511

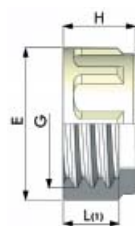

codice / code / code	G	DN mm(inch)	H	E	L(t)
0200122.000101	1/4"	7	15,5	20	13,5
0200122.000202	3/8"	9, 10, 12	18	23	15
0200122.000303	1/2"	10, 12, 13, 16	19	27,5	16
0200122.000505	3/4"	10, 12, 13, 16, 19, 20	20,5	33	17
0200122.000707	1"	20,22,25	21	40,5	18
0200122.000909	1 1/4"	25,30,32	23	50,5	18,5
0200122.001111	1 1/2"	38,40	23	55,5	18,5
0200122.001515	2"	50	23	70	18,5

0200122.000599	3/4"	16	15	33	12,5
0200122.000599	3/4"	20	15	33	12,5
0200122.000799	1"	25	18	40,5	15

0200137.000505	3/4"	11	16	33	13
----------------	------	----	----	----	----

Raccordo per lavatrice
Fitting for washing machines
Raccord pour lave-linge

0200125

GUARNIZIONE

piana in EPDM per i prodotti con i codici:

EPDM FLAT GASKET

for products with the codes:

JOINT

plat en EPDM pour les produits avec les codes:

0200120, 0200121, 0200180, 0200681, 0200650,
0200685, 0200651

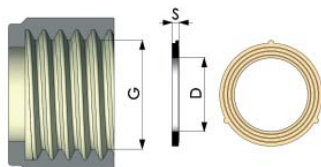

codice / code / code	G inch (mm)	D	S
0200125.160101	1/4" (11,4)	5,5	2,5
0200125.160202	3/8" (14,9)	7,5	2,5
0200125.160303	1/2" (18,6)	10,5	2,5
0200125.160505	3/4" (24,1)	15,5	2,5
0200125.160707	1" (30,2)	21	2,5
0200125.160909	1 1/4" (39,8)	26,5	2,5
0200125.161111	1 1/2" (44,8)	33,3	2,5
0200125.161515	2" (56,6)	43	2,5

0200132

CURVA a 90°

estremità maschio filettate G1

90° ELBOW

with male threaded ends G1

COUDE à 90°

extrémité mâle fileté G1

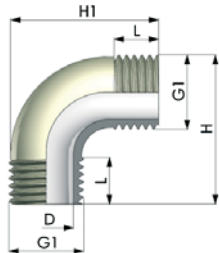

codice / code / code	G1	D	L	H	H1
0200132.000505	3/4"	20	15	65	56
0200132.000707	1"	24,5	15	70	68
0200132.000909	1"1/4	33	21	82	79

0200650

MEZZO RACCORDO DIRITTO RIDOTTO FEMMINA/MASCHIO

estremità femmina ghiera mobile filettata G con guarnizione piana in EPDM e l'altra maschio filettata G1

STRAIGHT REDUCING HALF FITTING

FEMALE / MALE

one female threaded movable ring nut G and EPDM flat gasket and one threaded male end G1

DEMI-RACCORD DROIT RÉDUIT

FEMELLE/MÂLE

extrémité femelle écrou mobile fileté G avec joint plat en EPDM et extrémité mâle fileté G1

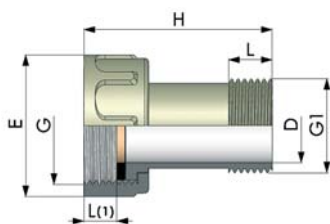

codice / code / code	G	G1	D	L(1)	L	E	H
0200650.000503	3/4"	1/2"	14,5	11,5	13	33	43
0200650.000705	1"	3/4"	19,5	12	14,5	40,5	48
0200650.000907	1"1/4	1"	25	13	16	50,5	53,5
0200650.001109	1"1/2	1"1/4	32,5	13	19	55,5	58

NEW

disponibile nel 2011
available in 2011
disponible en 2011

0200685

MEZZO RACCORDO CURVO a 90° FEMMINA/MASCHIO

estremità femmina ghiera mobile filettata G con guarnizione piana in EPDM e l'altra maschio filettata G1

ELBOW 90° HALF FITTING FEMALE/MALE

one female threaded movable ring nut G and EPDM flat gasket and one threaded male end G1

DEMI-RACCORD COUDÉ à 90°

FEMELLE/MÂLE

extrémité femelle écrou mobile fileté G avec joint plat en EPDM et extrémité mâle fileté G1

NEW

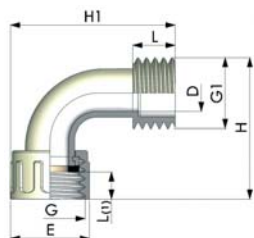

codice / code / code	G	G1	D	L(1)	L	E	H	H1
0200685.000707	1"	1"	19,5	11	16	40,5	75,5	68

mod. GOMITO a 90°

mod. 90° ELBOW

mod. COUDE à 90°

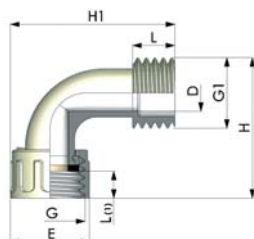

0200685.000505	3/4"	3/4"	15	10,5	14,5	33	65	66
----------------	------	------	----	------	------	----	----	----

0200651

MEZZO RACCORDO CURVO a 90° RIDOTTO FEMMINA/MASCHIO

estremità femmina ghiera mobile filettata G con guarnizione
piana in EPDM e l'altra maschio filettata G1

REDUCING ELBOW 90° HALF FITTING

FEMALE/MALE

one female threaded movable ring nut G and EPDM flat gasket
and one threaded male end G1

DEMI-RACCORD COUDÉ à 90° RÉDUIT

FEMELLE/MÂLE

extrémité femelle écrou mobile
fileté G avec joint
plat en EPDM et extrémité mâle
fileté G1

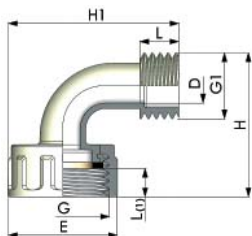

mod. GOMITO a 90°

mod. 90° ELBOW

mod. COUDE à 90°

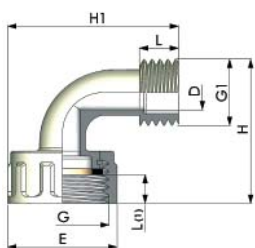

codice / code / code	G	G1	D	L(1)	L	E	H	H1	
0200651.000907	1"1/4	1"	24	12	17	50,5	73	79,5	
0200651.001109	1"1/2	1"1/4	33	11,5	19	55,5	97	90	

0200651.000503	3/4"	1/2"	19,5	15,5	8	33	57	54	
0200651.000705	1"	3/4"	19,5	10	15	40,5	64,5	62	

RACCORDI con filettatura GAS, in poliammide 66 (PA) - (nylon)

Polyamide 66 (PP) - (nylon) FITTINGS with GAS threading

RACCORDS avec filetage pas du GAZ, en polyamide 66 (PA) - (nylon)

0200180

CALOTTA

estremità femmina filettata G

CAP

with female threaded end G

BOUCHON

extrémité femelle filetée G

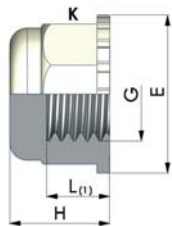

codice / code / code	G	L(1)	H	E	K
0200180.000202	3/8"	16	19	26,5	23
0200180.000303	1/2"	12	15	32	28
0200180.000505	3/4"	12,5	15,5	38	34
0200180.000707	1"	14	17,5	45,5	44

0200200

TAPPO

estremità maschio filettata G1

PLUG

with male threaded end G1

BOUCHON

extrémité mâle filetée G1

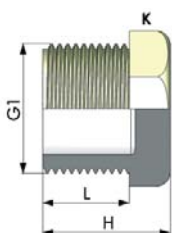

codice / code / code	G	L	H	K
0200200.000202	3/8"	13,5	21	22
0200200.000303	1/2"	14	22,5	27
0200200.000505	3/4"	15	24	34
0200200.000707	1"	15,5	25	40

0200210

NIPPLO

estremità maschio filettate G1

NIPPLE

with male threaded ends G1

MAMELON

extrémité mâle filetée G1

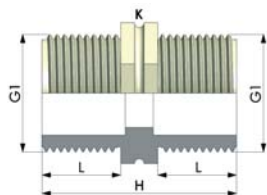

codice / code / code	G1	L	H	K
0200210.000202	3/8"	14,5	36	20
0200210.000303	1/2"	15,5	38	24
0200210.000505	3/4"	16	39	28
0200210.000707	1"	18	43	36
0200210.000909	1"1/4	20	57,5	46
0200210.001111	1"1/2	20	57,5	54
0200210.001515	2"	24	65,5	64

0200211

NIPPLO RIDOTTO

estremità maschio filettate G1 - G1(1)

REDUCING NIPPLE

with male threaded ends G1 - G1(1)

MAMELON RÉDUIT

extrémités mâles filetées G1 - G1(1)

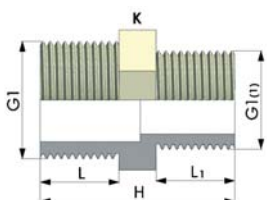

codice / code / code	G1	G1(1)	L	L1	H	K
0200211.000302	1/2"	3/8"	16	15	37	24
0200211.000503	3/4"	1/2"	16	15,5	38	27
0200211.000705	1"	3/4"	18	16	40,5	36
0200211.000907	1"1/4	1"	20	19	56	46
0200211.001107	1"1/2	1"	20	18,5	56	54
0200211.001109	1"1/2	1"1/4	20	20	57,5	54
0200211.001511	2"	1"1/2	24	20	61	63

0200178

RACCORDO A 5 VIE

estremità maschio filettate G1 - G1(1)

estremità femmina filettate G - G(1) - G(2)

5-WAY FITTING

with male threaded ends G1-G1(1)

with female threaded ends G-G(1)-G(2)

RACCORD À 5 PASSAGES

extrémités mâles filetées G1 - G1(1)

extrémités femelle-femelle filetées G - G(1) - G(2)

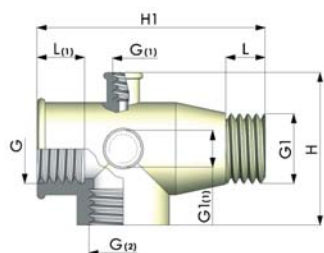

codice / code / code	G	G1	G1(1)	G(1)	G(2)	L	L(1)	H	H1
0200178.000507	3/4"	1"	1/4"	1/4"	1"	15	15	64	82
0200178.000707	1"	1"	1/4"	1/4"	1"	17	15	64	91

0200170

FILTRO

estremità femmina filettata G

FILTER

female threaded end G

CRÉPINE

extrémité femelle filetée G

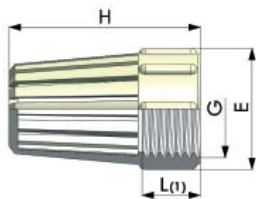

codice / code / code	G	L(1)	E	H
0200170.000707	1"	17,5	70	43
0200170.000909	1"1/4	17,5	77	52
0200170.001111	1"1/2	17,5	83	57,5
0200170.001515	2"	18,5	84	69

0200173

FILTRO

estremità maschio filettata G1

FILTER

with male threaded end G1

CRÉPINE

extrémité mâle filetée G1

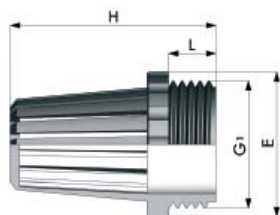

Colore nero
Black colour
Noir

codice / code / code	G	L	E	H
0200173.020303	1/2"	14	26	57
0200173.050505	3/4"	14,5	33,5	63
0200173.050707	1"	14,5	38,5	69

0200190

COLLARE di serraggio

con filettatura cilindrica G

Clamping COLLAR

with parallel female thread G

COLLIER de serrage

avec filet cylindrique G

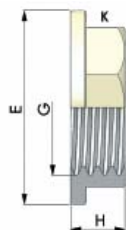

codice / code / code	G	H	E	K
0200190.000202	3/8"	14	33	25
0200190.000303	1/2"	15	38	28
0200190.000505	3/4"	15	43	32
0200190.000707	1"	14	50	41
0200190.000909	1"1/4	15	57	50
0200190.001111	1"1/2	15	63	57
0200190.001515	2"	16	77	70

VALVOLE ANTIRIFLUSSO, di fondo, di ritegno "YURI" con filettatura GAS, in resina acetalica (POM)

Acetal resin (POM) "YURI" BACKFLOW, foot, and check VALVES with GAS threading

CLAPETS DE NON-RETOUR, de pied, de retenue "YURI" avec filetage pas du GAZ, en résine acétalique (POM)

0200730

VALVOLA DI FONDO
con attacco femmina filettato G
FOOT VALVE
with female threaded connection G
CLAPET DE PIED
avec raccord femelle fileté G

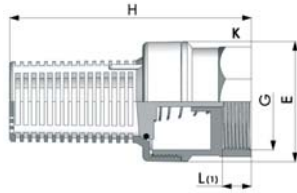

codice / code / code	G	L(1)	H	E	K
0200730.030909	1"1/4	18	122	57	50
0200730.031111	1"1/2	18	122	64	55
0200730.031515	2"	18	150	73,5	68

0200720

VALVOLA DI FONDO
"YURI"
con attacchi femmina filettati G
"YURI" FOOT VALVE
with female threaded connections G
CLAPET DE PIED "YURI"
avec raccords femelles filetés G

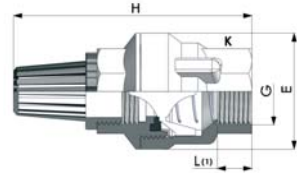

codice / code / code	G	L(1)	H	E	K
0200720.030303	1/2"	16	105	40	27
0200720.030505	3/4"	17	117	47	34
0200720.030707	1"	18	129	57	41

0200700

VALVOLA DI RITEGNO
"YURI"
con attacchi femmina filettati G
"YURI" CHECK VALVE
with female threaded connections G
CLAPET DE PIED "YURI"
avec raccords femelles filetés G

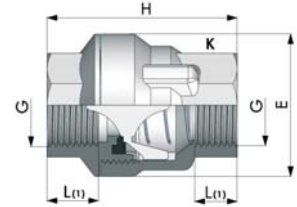

codice / code / code	G	L(1)	H	E	K
0200700.030303	1/2"	16	62	40	27
0200700.030505	3/4"	17	68	47	34
0200700.030707	1"	18	75	57	41

0200721

VALVOLA DI FONDO "YURI" in PP
con attacchi femmina filettati G
PP "YURI" FOOT VALVE
with female threaded connections G
CLAPET DE PIED "YURI" en PP
avec raccords femelles filetés G

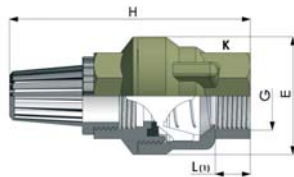

Fino ad esaurimento scorte
While stocks last
Jusqu'à épuisement des stocks

codice / code / code	G	L(1)	H	E	K
0200721.070707	1"	18	129	57	41

VALVOLE DI INTERCETTAZIONE, a sfera autoregistranti e monoghiera "ARIES" con filettatura GAS, in polipropilene (PP)

Polypropylene (PP) "ARIES" SHUT-OFF VALVES, self-adjusting and with one ring nut, GAS threading

VANNE DE SECTIONNEMENT, à bille autoréglables et avec un seul écrou "ARIES" avec filetage pas du GAZ, en polypropylène (PP)

0200320

VALVOLA A SFERA

con attacchi femmina filettati G

BALL VALVE

with threaded connections G

VANNE À BILLE

avec raccords femelles filetés G

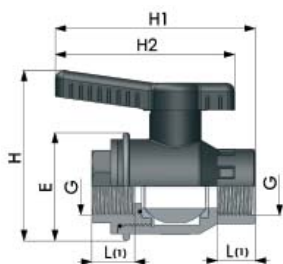

Tipo autoregistrante
Self-adjusting type
Auto-réglable

codice / code / code	G	L(1)	H	H1	H2	E
0200320.050303	1/2"	16	78	93	80	49
0200320.050505	3/4"	19	89	110	95	54
0200320.050707	1"	22	95	116	105	59

0200330

VALVOLA A SFERA

con attacchi: femmine filettato G e maschio filettato G1

BALL VALVE

with connections: threaded female end G and threaded male end G1

VANNE À BILLE

avec raccords: femelle fileté G et mâle fileté G1

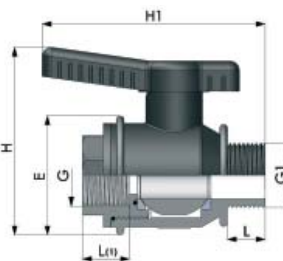

Tipo autoregistrante
Self-adjusting type
Auto-réglable

codice / code / code	G	G1	L	L(1)	H	H1	E
0200330.050303	1/2"	1/2"	16	16	78	97	49
0200330.050505	3/4"	3/4"	17	19	89	114	54
0200330.050707	1"	1"	19	22	95	124	59

0200350

VALVOLA A SFERA

con attacchi femmina filettati G

BALL VALVE

with female threaded connections G

VANNE À BILLE

avec raccords femelles filetés G

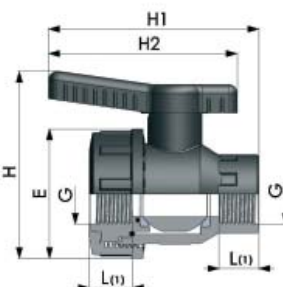

Tipo monoghiera
With one ring nut
Type avec un seul écrou

codice / code / code	G	L(1)	H	H1	H2	E
0200350.050303	1/2"	16	85	93	80	58
0200350.050505	3/4"	19	94	110	95	64
0200350.050707	1"	22	102	116	105	72

0200360

VALVOLA A SFERA

con attacchi femmina filettato G e maschio filettato G1

BALL VALVE

with female threaded G and male threaded G1

VANNE À BILLE

avec raccords femelle fileté G et mâle fileté G1

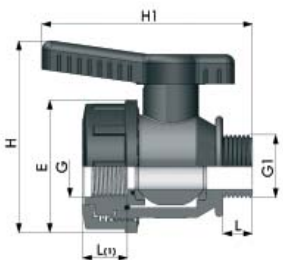

Tipo monoghiera
With one ring nut
Type avec un seul écrou

codice / code / code	G	G1	L	L(1)	H	H1	E
0200360.050303	1/2"	1/2"	16	17,5	85	97	58
0200360.050505	3/4"	3/4"	17	19	94	114	64
0200360.050707	1"	1"	19	22	102	124	72