

Cleco®

15G Series Horizontal Grinders

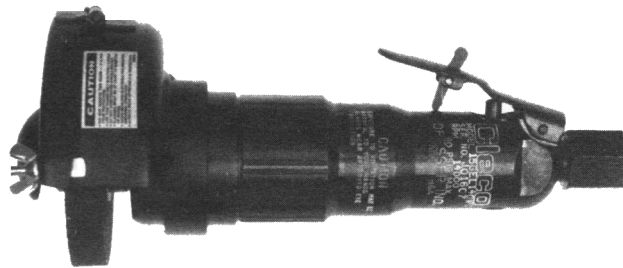

15 G L - XXX - X X X

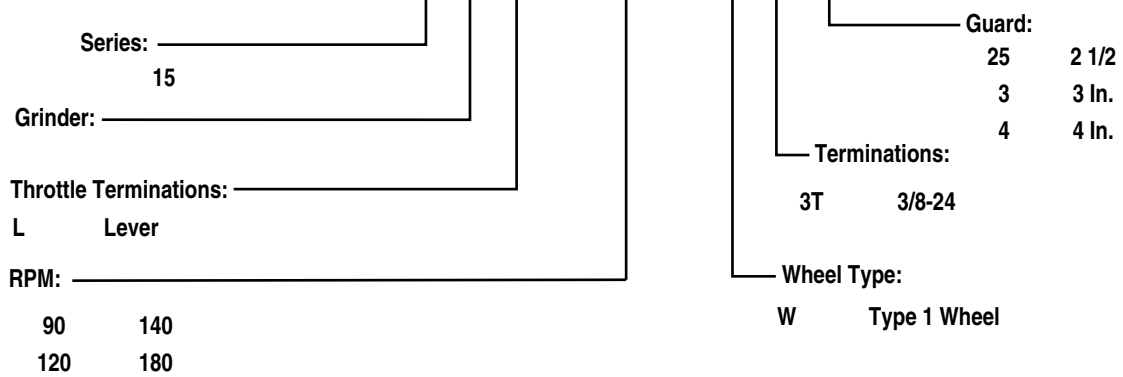

For additional product information visit our website at <http://www.clecotools.com>

NORTH AMERICA

CooperTools
P.O. Box 1410
Lexington, SC 29071

EUROPE

Cooper Power Tools GmbH & Co.
Postfach 30
D-73461 Westhausen

Safety Recommendations

For your safety and the safety of others, read and understand the safety recommendations before operating any grinder.

Always wear protective equipment and clothing.



Caution: Faceshields do not provide unlimited protection against flying particles and are not to be considered as eye protection. ANSI Z87.1 states that separate eyewear shall be used. For additional information on eye protection, refer to Federal OSHA Regulations, 29 CFR, Section 1910.133, Eye and Face Protection, and ANSI Z87.1, Occupational and Educational Eye and Face Protection. This standard is available from the American National Standards Institute, Inc., 11 West 42nd street, New York, NY 10036.

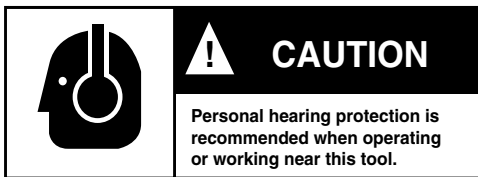

Hearing protection is recommended in high noise areas (above 85 dBA). Close proximity of additional tools, reflective surfaces, process noises, and resonant structures can substantially contribute to the sound level experienced by the operator. Proper hearing conservation measures, including annual audiograms and training in the use and fit of hearing protection devices may be necessary. For additional information on hearing protection, refer to Federal OSHA Regulations, 29 CFR, Section 1910.95, Occupational Noise Exposure, and American National Standards Institute, ANSI S12.6, Hearing Protectors.

- **Gloves and other protective clothing should be worn as required.**
- **Do not wear clothing that may restrict movement, become entangled or in any way interfere with the safe operation of grinders.**



Grinding or other use of this tool may produce hazardous fumes and/or dust. To avoid adverse health effects utilize adequate ventilation and/or a respirator. Read the material safety data sheet of any materials involved in the grinding process.

Cleco grinders are designed to operate on 90 psig (6.2 bar) max. air pressure. If the tool is properly sized and applied, higher air pressure is unnecessary. Excessive air pressure increases the loads and stresses on the tool parts and may result in breakage. Installation of a filter-regulator-lubricator in the air supply line is highly recommended.

Never use the air hose for supporting, lifting, or lowering the tool. Use a safety line or cable on the tool when working in elevated areas.

Before tool is connected to air supply, check throttle for proper operation, i.e., throttle moves freely and returns to closed position. Be careful not endanger adjacent personnel, clear air hose of accumulated dust and moisture. Use protective barriers where necessary — hot sparks can burn. Barriers also help reduce noise levels. Before removing tool from service or changing accessories, make sure air line is shut off and drained of air to prevent the tool from operating if the throttle is accidentally engaged. The use of a self-relieving valve for this purpose is highly recommended.

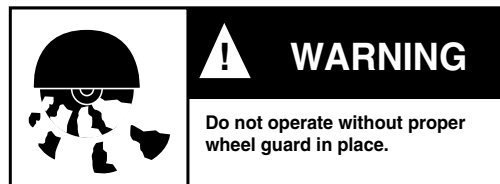

The wheel guard is designed to prevent serious injury to the operator in the event of wheel failure and must not be modified in any way. Any wheel guard that is damaged or bent must be replaced.

NOTE: The grinder must be held so that the opening in the guard is away from the operator.

Safety Recommendations

The guard must be securely attached to the grinder with all bolts, nuts and lockwashers in place and torqued to 30 to 40 in. lbs.

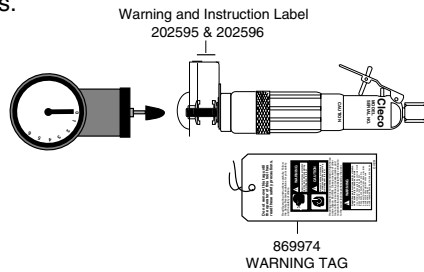

The speed rating and warnings are roll stamped on housing and should be replaced for legibility in the event of damage. Warning tags and warning labels should be maintained. Warning tags and warning labels are available from the manufacturer.

Before mounting a wheel, after all tool repairs, and whenever a grinder is issued for use, check the free speed of the grinder with a tachometer to make certain that the actual free speed at 90 psig (6.2 bar) does not exceed the rated free speed stamped on the tool. Grinders in use on the job must be similarly checked at least once every twenty hours of operation, or once every week, whichever is more frequent. Checking free speed after the removal of each worn wheel and before mounting a new wheel is highly recommended.

INSPECT THE GRINDING WHEEL!

Check the maximum safe RPM marked on the wheel. **Never use a wheel rated below the actual tool speed.** Inspect the wheel for cracks or chips, water stains, or signs of abuse or improper storage. **Cracked, chipped or faulty grinding wheels are dangerous and must not be used.** They must be destroyed rather than risk their use by someone who may not notice that they are damaged.



Causes of abrasive wheel failures have been traced to such factors as:

- Dropping, bumping, or abuse (careless handling of the grinder or wheel)

- Improper mounting
- Imbalance
- Improper shipment or storage
- Exposure to water, solvents, high humidity, freezing and extreme temperatures
- Mismatched speed ratings
- Age

Abrasive wheels known to have been subjected to any of the above conditions can burst violently. Never use an abrasive wheel known to have been subjected to any of the above conditions.

CHECK FLANGE

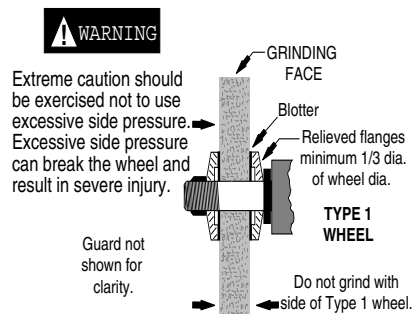

On Type 1 wheel grinders, the driving flanges must be the relieved-type, free of nicks and burrs or other flaws that might create stress concentrations on the grinding wheel. Spindles should be

checked for damage or abuse. Blotters must be used and be at least as large in diameter as the flanges. Diameters of both driving flange and outer flange must be identical and both must measure at least one-third the diameter of the grinding wheel mounted between them. Both flanges must be properly relieved as per ANSI Safety Code B7.1 and ANSI B186.1. (See page 6)

Select Type 1 wheels with proper hole size and speed rating. Never adapt wheels with an oversize hole to fit the spindle.

ABRASIVE WHEEL MOUNTING & BEGINNING GRINDING OPERATION

The spindle end nut should be tightened firmly against the outer flange of Type 1 wheels to assure the necessary friction against the blotter faces to drive the wheel.



Type 1 Wheel breakage can also occur if:

- Outer flange is left off
- Outer flange is reversed
- A washer is used in place of proper flange
- Outer flange and driving flange are of unequal diameters
- No wheel blotters are used

Safety Recommendations

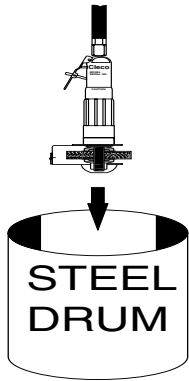

Before beginning operations or after mounting a wheel, the tool must be run for one (1) minute in a protected enclosure to check the integrity of the wheel. During this time or any other time, no one should stand in front of or in line of the wheel. When starting work with a cold wheel, apply it gradually to the workpiece until the wheel becomes warm.

before it becomes a debilitating injury. Any user suffering prolonged symptoms of tingling, numbness, blanching of fingers, clumsiness or weakened grip, nocturnal pain in the hand, or any other disorder of the shoulders, arms, wrists, or fingers is advised to consult a physician. If it is determined that the symptoms are job related or aggravated by movements and postures dictated by the job design, it may be necessary for the employer to take steps to prevent further occurrences. These steps might include, but are not limited to, repositioning the workpiece or redesigning the workstation, reassigning workers to other jobs, rotating jobs, changing work pace, and/or changing the type of tool used so as to minimize stress on the operator. Some tasks may require more than one type of tool to obtain the optimum operator/tool/task relationship.

DO NOT CONTINUE TO USE A GRINDER IF:

- It is not equipped with the proper wheel guard
- The speed rating of the wheel is less than the speed of the grinder
- It starts to vibrate
- You sense any changes in tool speed or an unusual increase in noise output that would indicate the tool is running at excessive speed.
- You notice excessive end play in the spindle
- You hear any unusual sound from the grinder

RETURN THE TOOL TO THE TOOL CRIB FOR SERVICE IMMEDIATELY!

⚠ WARNING

Repetitive work motions and/or vibration may cause injury to hands and arms.

Use minimum hand grip force consistent with proper control and safe operation. Keep body and hands warm and dry. Avoid anything that inhibits blood circulation. Avoid continuous vibration exposure. Keep wrists straight. Avoid repeated bending of wrists and hands.

Some individuals may be susceptible to disorders of the hands and arms when performing tasks consisting of highly repetitive motions and/or

exposure to extended vibration. Cumulative trauma disorders such as carpal tunnel syndrome and tendonitis may be caused or aggravated by repetitious, forceful exertions of the hands and arms. Vibration may contribute to a condition called Raynaud's Syndrome. These disorders develop gradually over periods of weeks, months, and years. It is presently unknown to what extent exposure to vibrations or repetitive motions may contribute to the disorders. Hereditary factors, vasculatory or circulatory problems, exposure to cold and dampness, diet, smoking and work practices are thought to contribute to the conditions. Any tool operator should be aware of the following warning signs and symptoms so that a problem can be addressed

The following suggestions will help reduce or moderate the effects of repetitive work motions and/or extended vibration exposure:

- Use a minimum hand grip force consistent with proper control and safe operation
- Keep body and hands warm and dry (cold weather is reported to be a major factor contributing to Raynaud's Syndrome)
- Avoid anything that inhibits blood circulation
 - Smoking Tobacco (another contributing factor)
 - Cold Temperatures
 - Certain Drugs

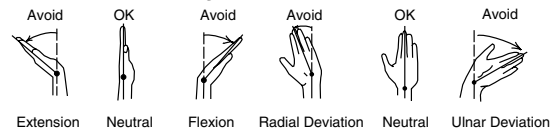

- Tasks should be performed in such a manner that the wrists are maintained in a neutral position, which is not flexed, hyperextended, or turned side to side
- Stressful postures should be avoided — select a tool appropriate for the job and work location
- Avoid highly repetitive movements of hands and wrists, and continuous vibration exposure (after each period of operation, exercise to increase blood circulation)
- Use quality abrasive wheels
- Keep tool well maintained and replace worn parts

Work gloves with vibration reducing liners and wrist supports are available from some manufacturers of industrial work gloves. Tool wraps and grips are also available from a number of different manufacturers. These gloves, wraps, and wrist supports are designed to reduce and moderate the effects of extended vibration exposure and repetitive

Safety Recommendations

wrist trauma. Since they vary widely in design, material, thickness, vibration reduction, and wrist support qualities, it is recommended that the glove, tool wrap, or wrist support manufacturer be consulted for items designed for your specific application. **WARNING! Proper fit of gloves is important. Improperly fitted gloves may restrict blood flow to the fingers and can substantially reduce grip strength.**

USE QUALITY ABRASIVE WHEELS

The primary source of vibration when using a portable grinder is an abrasive wheel that is out of balance, out of round, untrue, or possibly any combination of all three.

The use of quality abrasive wheels which are well balanced, round, and true is highly recommended as they have been found to significantly reduce vibration. Some abrasive wheels lose their balance, roundness, and trueness as they wear from use. Because of the abusive nature of the vibration caused by out of balance, out of round, and untrue condition of some abrasive wheels, it is felt that these wheels are more susceptible to failure. Excessive vibration may signal eminent wheel failure. Flat spotting of the abrasive wheel, caused by grinding the wheel to a stop after the power has been shut off can result in changes to the balance and shape of the wheel. Be sure the grinding wheel has stopped before setting the tool down. Set the tool in a tool rest or tool holder when not in use.

WIRE BRUSHES

If a grinder is used for wire brushing applications the same problems of balance, roundness, and trueness as experienced with abrasive wheels prevail. Use quality wire brushes. Wire brushes must be kept clean and stored properly to prevent bending, damage and corrosion. Excessive bending of wires during brushing causes breakage and flying wires. Wear full face protection, use guard and exercise caution.

USE A PREVENTIVE MAINTENANCE PROGRAM

Tool abuse or poor maintenance procedures can amplify and contribute to the vibration produced by the abrasive wheel. A preventive maintenance program featuring scheduled periodic inspections and proper maintenance is the best way to assure safety in your portable grinding operations. A well managed program can, for example, detect such things as speed variations due to wear, flanges or spindles that have been damaged from abuse, or bad bearings damaged by foreign matter or lack of lubrication. Problems such as these can affect the wheel trueness

when the grinder is running and contribute to the vibration. Rotor blades that are worn or chipped can lock up motor and result in grinding wheel spinoff and should be replaced. Rotor blades should be checked periodically and replaced if they measure less than $7/32"$ (5.6mm) at either end.

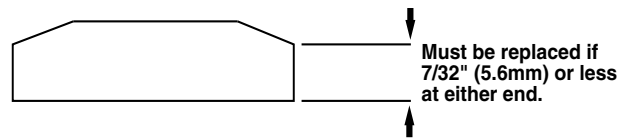

Proper repair procedures and the use of original Cleco service parts and bearings rather than substitutes will return the tool to factory specifications of precision and balance, and minimize vibration.

The governor should be checked periodically to be sure the governor mechanism is clean, in good operating condition, and functioning properly.

PROPER LUBRICATION

An automatic in-line filter-regulator-lubricator is recommended as it increases tool life and keeps the tool in sustained operation. The in-line lubricator should be regularly checked and filled with a good grade of 10W machine oil. Proper adjustment of the in-line lubricator is performed by placing a sheet of paper next to the exhaust ports and holding the throttle open approximately 30 seconds. The lubricator is properly set when a light stain of oil collects on the paper. Excessive amounts of oil should be avoided.

STORAGE

In the event that it becomes necessary to store the tool for an extended period of time (overnight, weekend, etc.), it should receive a generous amount of lubrication at that time and run for several seconds to distribute the oil before disconnecting from the air supply. This will reduce the possibility of corrosion and displace any water that may be trapped in the tool. Water trapped in the tool could cause the governor to freeze and malfunction if tool is exposed to freezing temperatures.

Note: Water in the air system increases tool maintenance costs and can cause the tool to malfunction when it is stored and/or operated in freezing conditions.

For more information, see the latest edition of ANSI B186.1, Safety Code for Portable Air Tools, and ANSI B7.1 Safety Requirements for the Use, Care, and Protection of Abrasive Wheels available from the American National Standards Institute, Inc., 11 West 42nd street, New York, NY 10036.

TYPE 1 WHEEL GUARD MOUNTING

Wheel Guard	
Wheel Dia.	Part No.
2-1/2"(62mm)	865787
3"(75mm)	865786
4"(100mm)	865988

Wheel Guard Retainer Bolt
Torque to 30 to 40 in. lbs.

Recessed Flanges (Driving)	
Wheel Dia.	Part No.
2-1/2"(62mm), 3"(75mm)	865653
4"(100mm)	865990

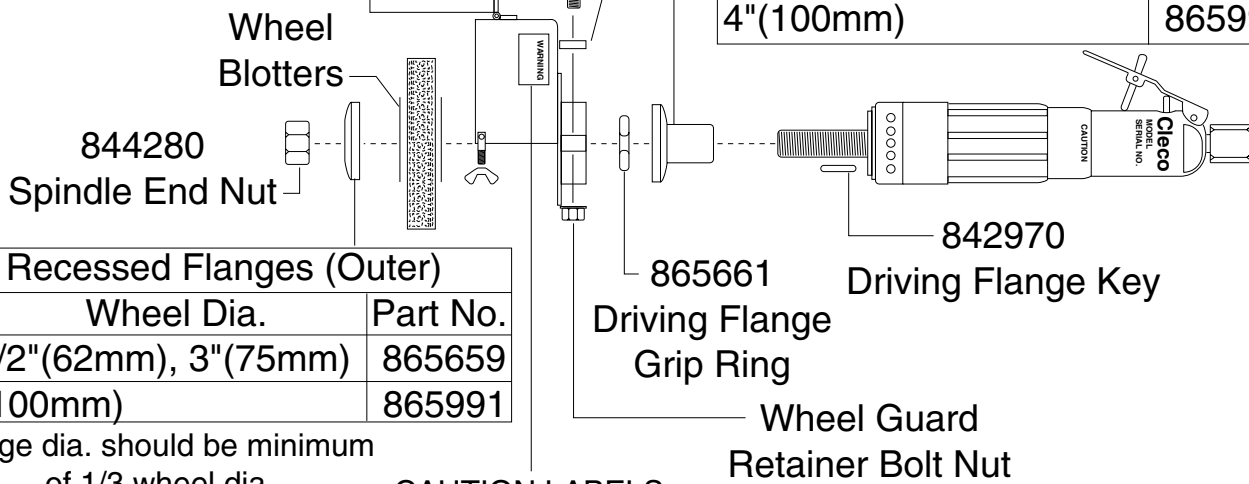

Recessed Flanges (Outer)	
Wheel Dia.	Part No.
2-1/2"(62mm), 3"(75mm)	865659
4"(100mm)	865991

Flange dia. should be minimum
of 1/3 wheel dia.

CAUTION LABELS

(2 Required 202595 and 202596)

- CAUTION**

 - DO NOT REMOVE THIS GUARD Ñ IT IS FOR YOUR PROTECTION
 - USE THIS GUARD ONLY WITH TYPE 1 WHEELS
 - DO NOT OVERTIGHTEN SPINDLE END NUT
 - FLANGES MUST BE AT LEAST 1/3 DIAMETER OF WHEEL
 - AVOID INHALING DUST RESULTING FROM THE GRINDING OPERATION
 - ALWAYS USE EYE AND HEARING PROTECTION

202595

- CAUTION**

 - DO NOT USE WHEELS THAT HAVE BEEN DROPPED, DAMAGED, OR IMPROPERLY STORED Ñ THEY ARE DANGEROUS
 - USE ONLY WHEELS WITH SPEED RATING EQUAL TO OR GREATER THAN ACTUAL FREE RUNNING TOOL SPEED
 - CHECK TOOL SPEED WITH TACHOMETER BEFORE EVERY WHEEL CHANGE
 - READ THE MANUFACTURER'S OPERATING INSTRUCTIONS AND SAFETY INSTRUCTIONS BEFORE USING THIS GRINDER

202596

TYPE 1 PROPER GRINDING WHEEL MOUNTING

Type 1 Wheel Capacity		
Model	Wheel Dia.	Wheel Thickness
15GL-180	2" - 3"	1/16" - 1/2"
15GL-140	2" - 4"	1/16" - 1/2"
15GL-120	2" - 4"	1/16" - 1/2"
15GL-90	2" - 4"	1/16" - 1/2"

Use Only Wheels With Speed
Rating Above Tool Speed

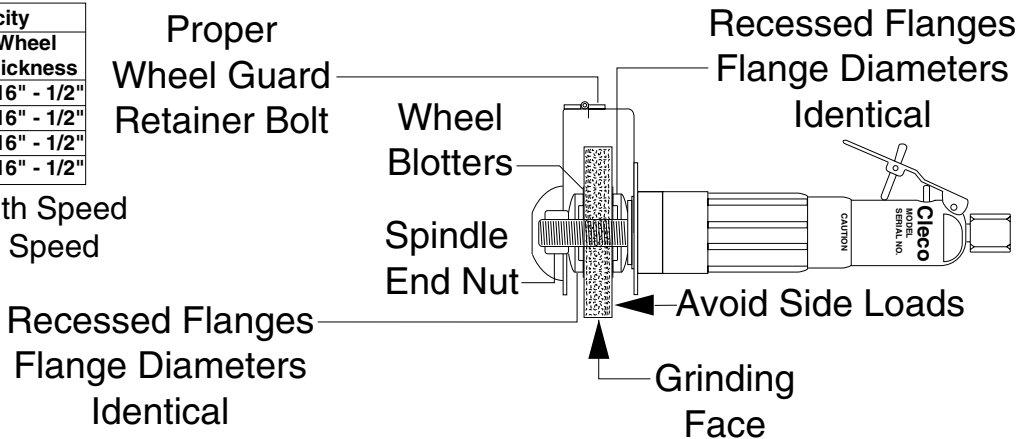

OPERATING AND SERVICE INSTRUCTIONS

READ SAFETY RECOMMENDATIONS BEFORE CONNECTING TOOL.

The 15G Series Grinders are designed to operate on 90 psig (6.2 bar) maximum air pressure, using a 3/8" hose up to 8' in length. If additional length is required, the next larger hose size may be connected to the 8' whip hose.

LUBRICATION

An automatic in-line filter- regulator- lubricator is recommended as it increases tool life and keeps the tool in sustained operation. The in-line lubricator should be regularly checked and filled with a good grade of 10W machine oil. Proper adjustment of the in-line lubricator is performed by placing a sheet of paper next to the exhaust ports and holding the throttle open approximately 30 seconds. The lubricator is properly set when a light stain of oil collects on the paper. Excessive amounts of oil should be avoided.

STORAGE

In the event that it becomes necessary to store the tool for an extended period of time (overnight, weekend, etc.), it should receive a generous amount of lubrication at that time and again when returned to service. The tool should be stored in a clean and dry environment.

DISASSEMBLY

To disassemble the 15G model, remove the retainer ring, driving flange, exhaust deflector retainer ring, exhaust deflector, and unscrew the front bearing retainer, No. 865697, (left hand threads). The motor assembly may now be slipped out the front of the backhead.

REASSEMBLY

If the tool has been completely disassembled, assemble the various subassemblies per their instructions. After assembly of the complete tool, the R.P.M. must be checked.

To change the R.P.M. setting on the 15G, the governor will have to be removed (left hand threads) and the governor adjusting screw rotated clockwise to decrease the speed, and counter-clockwise to increase the speed.

Check speed of tool before mounting wheel. Mount wheel guard before mounting wheel.

15G MOTOR & GOVERNOR

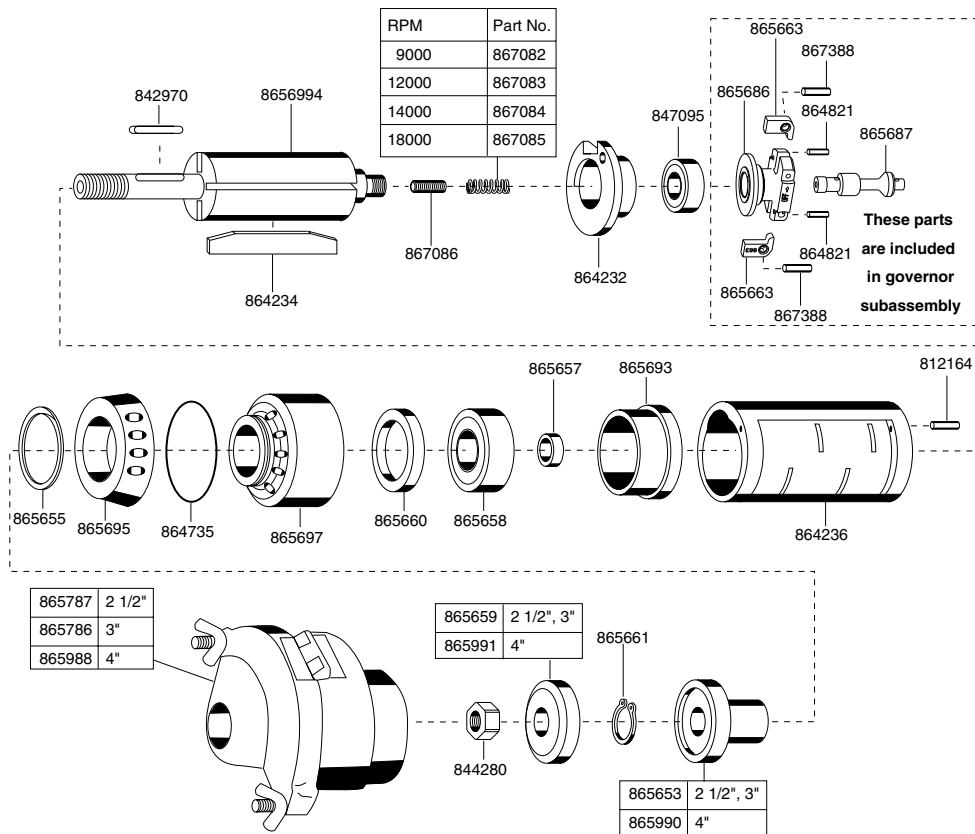

SERVICE INSTRUCTIONS FOR 15G MOTOR & GOVERNOR

DISASSEMBLY

Clamp the cylinder 864236, lightly in a soft jawed vise and tap the rotor 865694, out of the front rotor bearing 865658. This will allow the front rotor bearing, front bearing plate, 865693, rotor collar, 865657, cylinder, and rotor blades, 864234, to be removed from the rotor. Clamp the rotor in the vise and unscrew the governor (left hand threads). The governor adjusting screw, 867086, may now be removed from the rear of the rotor.

REASSEMBLY

The motor is reassembled in the reverse order of disassembly. Wash all parts thoroughly in a solvent and visually inspect for damage or wear. Check bearings for wear which can be detected by excessive end play, or roughness of the bearings which indicates a brinelled condition. Pack both rotor bearings with a good grade of No. 2 Moly Grease. Particular

attention should be paid to the governor assembly, replacing any of its' parts that show wear or damage. It is recommended that new rotor blades be installed at each repair cycle. If not replaced, the used ones must measure a minimum of 7/32" (5.5mm) at both ends. Failure of these parts could cause damage to more expensive components. Also, be sure that the blades are no longer than the rotor.

The rotor in this tool must be set by means of the rotor collar, 865657, so that when assembled, there is .0015" clearance between the front end of the rotor and the face of the front bearing plate. To properly set the rotor collar, assemble the front bearing (shield toward backhead) into the front bearing plate. Measure the depth of the inner race from the face of the bearing plate. Select, or fit by sanding, an rotor collar .0015" larger than this dimension. Governor center 865687, governor weights 865663, and governor pins No. 867388, should be checked periodically for wear and replaced if excessively worn.

PARTS LIST — 15G MOTOR & GOVERNOR

PART NO.	NAME OF PARTS	QTY.	PART NO.	NAME OF PARTS	QTY.
812164	Cylinder Pin	1	865686	Governor Spider *	1
842970	Key	1	865687	Governor Center *	1
844280	Arbor Nut	1	865693	Front Bearing Plate	1
847095	Rear Rotor Bearing	1	865694	Rotor	1
864232	Rear Bearing Plate	1	865695	Exhaust Deflector	1
864234	Rotor Blades	4	865697	Front Bearing Retainer	4
864236	Cylinder	1	865786	Wheel Guard (3")	1
864735	"O"-Ring	1	865787	Wheel Guard (2-1/2")	1
864821	Safety Lock Pin *	2	865988	Wheel Guard (4")	2
865653	Driving Flange	1	865990	Driving Flange (4")	1
865655	Exhaust Deflector Retainer Ring	1	865991	Outer Flange (4")	1
865657	Rotor Collar	1	867082	Governor Spring - See Chart	1
865658	Front Rotor Bearing	1	867083	Governor Spring - See Chart	1
865659	Outer Flange	1	867084	Governor Spring - See Chart	1
865660	Dust Seal	1	867085	Governor Spring - See Chart	1
865661	Arbor Collar Grip Ring	1	867086	Governor Adjustment Screw	1
865663	Governor Weight *	2	867388	Governor Weight Pin *	2

*These parts can be purchased as a subassembly using number: 861176

15G HANDLE

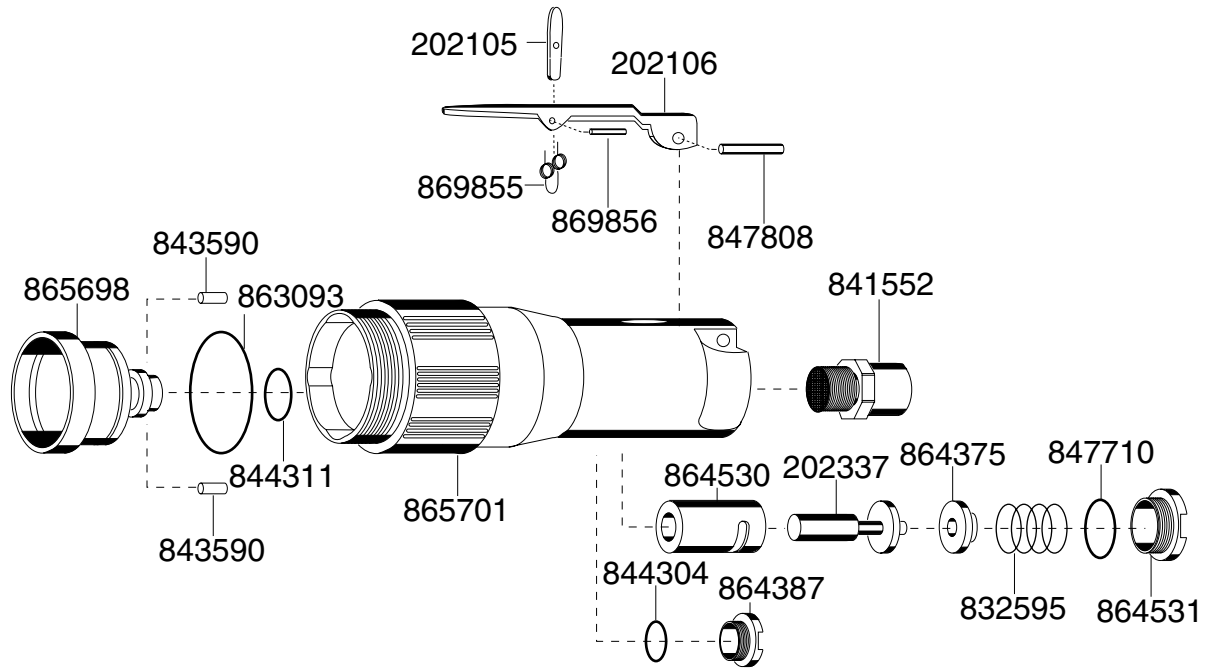

SERVICE INSTRUCTIONS FOR 15G HANDLE

DISASSEMBLY

To disassemble the lever throttle handle, unscrew the throttle valve cap 864531. This will allow the complete throttle valve assembly to be removed from the handle.

The oiler body on the handle may be removed from the front of the handle with the aid of spreaders.

REASSEMBLY

The handle is reassembled in the reverse order of disassembly. All parts should be inspected for damage or wear. Should a throttle valve bushing need replacing, be sure to align air ports. Air screens should be cleaned and replaced if torn.

PARTS LIST — 15G HANDLE

PART NO.	NAME OF PART	QTY.	PART NO.	NAME OF PART	QTY.
202105	Toggle	1	847808	Throttle Lever Pin	1
202106	Lock-Off Lever	1	863093	"O"-Ring 1" x 1-1/8"	1
202337	Throttle Valve	1	864375	Throttle Valve Seal	1
832595	Throttle Valve Spring	1	864387	Oil Fill Plug	1
841552	Inlet Bushing	1	864530	Valve Bushing	1
843590	Oiler Valve	2	864531	Valve Cap	1
844304	"O"-Ring 7/32" x 11/32"	1	865698	Oiler Body (Incl.843590)	1
844311	"O"-Ring 9/16" x 3/4"	1	865701	Backhead (Incl.864530)	1
845409	Toggle Pin	1	869855	Toggle Spring	1
847710	"O"-Ring 1/2" x 5/8"	1			

The complete handle assembly can be purchased using Part No. 201019.

The lock-off lever can be purchased as a subassembly using Part No. 861992.



CooperTools
670 Industrial Drive
Lexington, SC 29072
Phone: (803) 359-1200
Fax: (803) 359-2013
www.clecotools.com