

# Nokia E90 Communicator User Guide

---



**NOKIA**  
Eseries

**Nokia E90 Communicator**

DECLARATION OF CONFORMITY



Hereby, NOKIA CORPORATION declares that this RA-6 product is in compliance with the essential requirements and other relevant provisions of Directive: 1999/5/EC. A copy of the Declaration of Conformity can be found at [http://www.nokia.com/phones/declaration\\_of\\_conformity/](http://www.nokia.com/phones/declaration_of_conformity/).

© 2007 Nokia. All rights reserved.

Nokia, Nokia Connecting People, Nokia Care, Eseries and E90 are trademarks or registered trademarks of Nokia Corporation. Nokia tune is a sound mark of Nokia Corporation. Other product and company names mentioned herein may be trademarks or tradenames of their respective owners.

Reproduction, transfer, distribution, or storage of part or all of the contents in this document in any form without the prior written permission of Nokia is prohibited.



This product includes software licensed from Symbian Software Ltd © 1998-2007. Symbian and Symbian OS are trademarks of Symbian Ltd.

US Patent No 5818437 and other pending patents. T9 text input software Copyright © 1997-2007. Tegic Communications, Inc. All rights reserved.



Java and all Java-based marks are trademarks or registered trademarks of Sun Microsystems, Inc.

This product is licensed under the MPEG-4 Visual Patent Portfolio License (i) for personal and noncommercial use in connection with information which has been encoded in compliance with the MPEG-4 Visual Standard by a consumer engaged in a personal and noncommercial activity and (ii) for use in connection with MPEG-4 video provided by a licensed video provider. No license is granted or shall be implied for any other use. Additional information, including that related to promotional, internal, and commercial uses, may be obtained from MPEG LA, LLC. See <http://www.mpegla.com>.

Nokia operates a policy of ongoing development. Nokia reserves the right to make changes and improvements to any of the products described in this document without prior notice.

TO THE MAXIMUM EXTENT PERMITTED BY APPLICABLE LAW, UNDER NO CIRCUMSTANCES SHALL NOKIA OR ANY OF ITS LICENSORS BE RESPONSIBLE FOR ANY LOSS OF DATA OR INCOME OR ANY SPECIAL, INCIDENTAL, CONSEQUENTIAL OR INDIRECT DAMAGES HOWSOEVER CAUSED.

THE CONTENTS OF THIS DOCUMENT ARE PROVIDED "AS IS". EXCEPT AS REQUIRED BY APPLICABLE LAW, NO WARRANTIES OF ANY KIND, EITHER EXPRESS OR IMPLIED, INCLUDING, BUT NOT LIMITED TO, THE IMPLIED WARRANTIES OF MERCHANTABILITY AND FITNESS FOR A PARTICULAR PURPOSE, ARE MADE IN RELATION TO THE ACCURACY, RELIABILITY OR CONTENTS OF THIS DOCUMENT. NOKIA RESERVES THE RIGHT TO REVISE THIS DOCUMENT OR WITHDRAW IT AT ANY TIME WITHOUT PRIOR NOTICE.

The availability of particular products and applications and services for these products may vary by region. Please check with your Nokia dealer for details, and availability of language options.

Export controls

This device may contain commodities, technology or software subject to export laws and regulations from the US and other countries. Diversion contrary to law is prohibited.

FCC/INDUSTRY CANADA NOTICE

Your device may cause TV or radio interference (for example, when using a telephone in close proximity to receiving equipment). The FCC or Industry Canada can require you to stop using your telephone if such interference cannot be eliminated. If you require assistance, contact your local service facility. This device complies with part 15 of the FCC rules. Operation is subject to the following two conditions: (1) This device may not cause harmful interference, and (2) this device must accept any interference received, including interference that may cause undesired operation. Any changes or modifications not expressly approved by Nokia could void the user's authority to operate this equipment.

Model number: E90-1

9251240/Issue 2

# Contents

|   |           |  |           |
|---|-----------|--|-----------|
| <b>For your safety</b> .....                        | <b>6</b>  | Call and send messages from Log.....             | 25        |
| About your device.....                              | 6         | Log settings.....                                | 25        |
| Network services.....                               | 7         | <b>6. Messaging</b> .....                        | <b>26</b> |
| Enhancements, batteries, and chargers.....          | 7         | Organize messages.....                           | 26        |
| <b>1. Get started</b> .....                         | <b>8</b>  | Message reader.....                              | 26        |
| Insert the SIM card and battery.....                | 8         | Text messages.....                               | 26        |
| Insert the memory card.....                         | 9         | Sending options for text messages.....           | 27        |
| Eject the memory card.....                          | 10        | Text messages on the SIM card.....               | 27        |
| Charge the battery.....                             | 10        | Picture messages.....                            | 27        |
| Connect the headset.....                            | 10        | Multimedia messages.....                         | 27        |
| Keys and parts on the cover.....                    | 11        | Create and send multimedia messages.....         | 27        |
| Keys and parts on the communicator.....             | 12        | Create presentations.....                        | 28        |
| Camera.....   | 12        | Receive and reply to multimedia messages.....    | 28        |
| First start-up.....                                 | 13        | View presentations.....                          | 28        |
| About the display.....                              | 13        | View media objects.....                          | 28        |
| Display indicators.....                             | 13        | View and save multimedia attachments.....        | 29        |
| Antennas.....                                       | 14        | E-mail messages.....                             | 29        |
| Lock the keys.....                                  | 14        | Set up your e-mail with the mailbox guide.....   | 29        |
| Nokia support and contact information.....          | 14        | Connect to a remote mailbox.....                 | 29        |
| <b>2. Basic information about your device</b> ..... | <b>15</b> | Read and reply to e-mail.....                    | 30        |
| Welcome.....  | 15        | Delete messages.....                             | 30        |
| Switch from cover use to communicator.....          | 15        | Subfolders in your remote e-mail.....            | 30        |
| Menu.....   | 15        | Special messages.....                            | 30        |
| Common actions in several applications.....         | 15        | Send service commands.....                       | 30        |
| Standby modes.....                                  | 16        | Receive cell broadcast messages.....             | 31        |
| Active standby.....                                 | 16        | Instant messaging .....                          | 31        |
| Standby.....  | 16        | Define IM settings.....                          | 31        |
| Write text with the cover keypad.....               | 16        | Start a conversation.....                        | 31        |
| Traditional text input.....                         | 16        | IM groups.....                                   | 31        |
| Predictive text input.....                          | 17        | Block users.....                                 | 32        |
| Change the writing language.....                    | 17        | Cell broadcast.....                              | 32        |
| Volume control.....                                 | 17        | Service messages.....                            | 32        |
| Profiles .....                                      | 17        | Messaging settings.....                          | 32        |
| Select ringing tones.....                           | 17        | Text message settings.....                       | 33        |
| Themes .....  | 18        | Multimedia message settings.....                 | 33        |
| Memory.....   | 18        | E-mail account settings.....                     | 33        |
| Memory card .....                                   | 18        | User settings.....                               | 33        |
| MicroSD.....  | 18        | Retrieval settings.....                          | 34        |
| Use a memory card.....                              | 18        | Automatic retrieval settings.....                | 34        |
| Help and tutorial.....                              | 19        | Cell broadcast settings.....                     | 34        |
| Device help .....                                   | 19        | Other settings.....                              | 34        |
| Tutorial .....                                      | 19        | <b>7. Contacts</b> .....                         | <b>35</b> |
| Settings wizard .....                               | 19        | Copy contacts between SIM and device memory..... | 35        |
| Nokia PC Suite.....                                 | 19        | Manage contacts.....                             | 35        |
| <b>3. Transfer content between devices</b> .....    | <b>20</b> | Manage contact groups.....                       | 35        |
| Synchronize data with another device.....           | 20        | Add ringing tones for contacts.....              | 35        |
| <b>4. Telephone</b> .....                           | <b>21</b> | Business cards.....                              | 36        |
| Answer a call.....                                  | 21        | SIM directory and other SIM services.....        | 36        |
| Make a call.....                                    | 21        | <b>8. Calendar</b> .....                         | <b>37</b> |
| Make a conference call.....                         | 21        | Create calendar entries.....                     | 37        |
| Video calls.....                                    | 21        | To-do entries.....                               | 37        |
| Video sharing.....                                  | 22        | Calendar views.....                              | 38        |
| Share a video.....                                  | 22        | Month view.....                                  | 38        |
| Receive a video sharing invitation.....             | 22        | Week view.....                                   | 38        |
| Net calls .....                                     | 22        | Day view.....                                    | 38        |
| Create a net call profile.....                      | 22        | To-do view.....                                  | 38        |
| Connect to the net call service.....                | 23        | Calendar settings.....                           | 38        |
| Make net calls .....                                | 23        | <b>9. Clock</b> .....                            | <b>39</b> |
| Speed dialing .....                                 | 23        | Alarm clock.....                                 | 39        |
| Call divert.....                                    | 23        | World clock.....                                 | 39        |
| Define the number for call diverting.....           | 23        | Clock settings.....                              | 39        |
| Call barring.....                                   | 24        | <b>10. Office applications</b> .....             | <b>40</b> |
| Net call barring.....                               | 24        | File manager .....                               | 40        |
| Change the barring password.....                    | 24        | Search .....                                     | 40        |
| Send DTMF tones.....                                | 24        | Calculator .....                                 | 40        |
| Voice mail .....                                    | 24        | Nokia Team Suite .....                           | 40        |
| <b>5. Log</b> .....                                 | <b>25</b> | Edit teams.....                                  | 41        |
| Monitor all communications.....                     | 25        | Quickoffice .....                                | 41        |

## Contents

|   |           |   |           |
|---|-----------|---|-----------|
| Active notes .....  | 41        | Voice aid .....                                 | 58        |
| Create and edit notes.....  | 41        | Speech .....                                    | 58        |
| Settings for active notes.....                                      | 42        | Voice commands .....                            | 59        |
| Converter .....   | 42        | Make a call.....                                | 59        |
| Convert measurements.....   | 42        | Launch an application.....                      | 59        |
| Set base currency and exchange rate.....                            | 42        | Change profiles.....                            | 59        |
| PDF reader .....  | 42        | Voice command settings.....                     | 59        |
| Zip manager .....   | 42        | <b>16. Media applications.....</b>              | <b>60</b> |
| Print .....   | 42        | RealPlayer .....                                | 60        |
| Wireless keyboard .....   | 43        | Play video clips and stream links.....          | 60        |
| Notes .....   | 43        | Send audio files and video clips.....           | 60        |
| <b>11. Connectivity.....</b>  | <b>44</b> | View information about a media clip.....        | 60        |
| Modem .....   | 44        | RealPlayer settings.....                        | 60        |
| Cable connection .....  | 44        | Music player .....                              | 60        |
| Connection manager .....  | 44        | Listen to music.....                            | 61        |
| Search for WLAN.....  | 44        | Track lists.....                                | 61        |
| Bluetooth .....   | 45        | Equalizer.....                                  | 61        |
| Send and receive data with Bluetooth.....                           | 45        | Flash player .....                              | 61        |
| Pair devices.....   | 45        | Camera .....                                    | 61        |
| Security tips.....  | 46        | Capture an image.....                           | 62        |
| Bluetooth connectivity indicators.....                              | 46        | Camera toolbar.....                             | 62        |
| SIM access profile.....   | 46        | After capturing an image.....                   | 62        |
| Infrared .....  | 47        | Still image settings.....                       | 62        |
| Internet access points.....   | 47        | Record a video clip.....                        | 62        |
| Set up an internet access point for data calls.....                 | 47        | After recording a video clip.....               | 62        |
| Advanced internet access point settings for data calls.....         | 48        | Video settings.....                             | 63        |
| Set up an internet access point for packet data (GPRS).....         | 48        | Gallery .....                                   | 63        |
| Advanced internet access point settings for packet data (GPRS)..... | 48        | Images.....                                     | 63        |
| <b>12. Wireless local area network.....</b>                         | <b>49</b> | Manage image files.....                         | 63        |
| See WLAN availability.....  | 49        | Organize images.....                            | 63        |
| WLAN connections.....   | 49        | Radio .....                                     | 64        |
| WLAN wizard .....   | 49        | 3-D ringing tones .....                         | 64        |
| WLAN access points.....   | 50        | <b>17. Settings .....</b>                       | <b>65</b> |
| Set up an internet access point for WLAN manually.....              | 50        | General settings.....                           | 65        |
| Advanced internet access point settings for WLAN.....               | 50        | Personalization settings.....                   | 65        |
| WLAN settings.....  | 50        | Display settings.....                           | 65        |
| <b>13. Web .....</b>  | <b>51</b> | Standby mode settings.....                      | 65        |
| Access points.....  | 51        | Tone settings.....                              | 65        |
| Browse the web.....   | 51        | Language settings.....                          | 66        |
| Bookmarks.....  | 51        | Date and time settings.....                     | 66        |
| End a connection.....   | 51        | Enhancement settings.....                       | 66        |
| Clear the cache.....  | 51        | Device security .....                           | 66        |
| News feeds and blogs.....   | 52        | Device and SIM card security.....               | 66        |
| General settings.....   | 52        | Restore original settings.....                  | 67        |
| Page settings.....  | 52        | Telephone settings.....                         | 67        |
| Privacy settings.....   | 52        | Call settings.....                              | 67        |
| Web feed settings.....  | 52        | Network settings.....                           | 67        |
| <b>14. Global Positioning System (GPS) .....</b>                    | <b>53</b> | Connection settings.....                        | 67        |
| Nokia Maps .....  | 53        | Access points.....                              | 68        |
| Download maps.....  | 53        | Packet data settings.....                       | 68        |
| Satellite information.....  | 54        | WLAN settings.....                              | 68        |
| Browse maps.....  | 54        | Advanced WLAN settings.....                     | 68        |
| Search for locations.....   | 54        | WLAN security settings.....                     | 68        |
| Plan a route.....   | 54        | WEP security settings.....                      | 68        |
| Extra services for Maps.....  | 55        | WEP key settings.....                           | 69        |
| GPS data .....  | 55        | 802.1x security settings.....                   | 69        |
| Landmarks .....   | 56        | WPA security settings.....                      | 69        |
| Edit landmarks.....   | 56        | EAP.....  | 69        |
| Landmark categories.....  | 56        | Data call settings.....                         | 69        |
| Receive landmarks.....  | 56        | Session initiation protocol (SIP) settings..... | 70        |
| <b>15. Business voice applications.....</b>                         | <b>57</b> | Edit SIP profiles.....                          | 70        |
| Push to talk .....  | 57        | Edit SIP proxy servers.....                     | 70        |
| Push-to-talk settings.....  | 57        | Edit registration servers.....                  | 70        |
| Log in to push-to-talk service.....                                 | 57        | Net call settings.....                          | 70        |
| Make a push-to-talk call.....                                       | 57        | Configurations.....                             | 70        |
| Manage PTT contacts.....  | 57        | Application settings.....                       | 71        |
| Create a PTT channel.....   | 57        | <b>18. Device and data management.....</b>      | <b>72</b> |
| Exit push to talk.....  | 58        | Back up data.....                               | 72        |
| Recorder .....  | 58        | Remote configuration .....                      | 72        |
| Play a voice recording.....   | 58        | Application manager .....                       | 72        |
| Voice recorder settings.....  | 58        | Install applications.....                       | 72        |
|   |           | Installation settings.....                      | 73        |
|   |           | Java security settings.....                     | 73        |
|   |           | Activation keys .....                           | 73        |

## Contents

|   |           |
|---|-----------|
| Data synchronization .....                          | 74        |
| Create a synchronization profile.....               | 74        |
| Select applications to synchronize.....             | 74        |
| Synchronization connection settings.....            | 74        |
| Barcode reader .....                                | 75        |
| Download! .....                                     | 75        |
| Select catalogs, folders, and items.....            | 75        |
| Download! settings.....                             | 75        |
| <b>19. Security.....</b>                            | <b>76</b> |
| Fixed dialing.....                                  | 76        |
| Certificate manager.....                            | 76        |
| Certificate trust settings.....                     | 76        |
| View certificate details.....                       | 76        |
| Security modules.....                               | 77        |
| Security module codes.....                          | 77        |
| Memory card security.....                           | 77        |
| Lock the device.....                                | 77        |
| <b>20. Shortcuts.....</b>                           | <b>78</b> |
| <b>21. Glossary.....</b>                            | <b>80</b> |
| <b>Battery information.....</b>                     | <b>82</b> |
| <b>Nokia battery authentication guidelines.....</b> | <b>83</b> |
| Authenticate hologram.....                          | 83        |
| What if your battery is not authentic?.....         | 83        |
| <b>Care and maintenance.....</b>                    | <b>84</b> |
| Disposal.....                                       | 84        |
| <b>Additional safety information.....</b>           | <b>85</b> |
| Small children.....                                 | 85        |
| Operating environment.....                          | 85        |
| Medical devices.....                                | 85        |
| Implanted medical devices.....                      | 85        |
| Hearing aids.....                                   | 85        |
| Vehicles.....                                       | 85        |
| Potentially explosive environments.....             | 85        |
| Emergency calls.....                                | 86        |
| CERTIFICATION INFORMATION (SAR).....                | 86        |
| <b>Index.....</b>                                   | <b>87</b> |

## For your safety

---

Read these simple guidelines. Not following them may be dangerous or illegal. Read the complete user guide for further information.



### SWITCH ON SAFELY

Do not switch the device on when wireless phone use is prohibited or when it may cause interference or danger.



### ROAD SAFETY COMES FIRST

Obey all local laws. Always keep your hands free to operate the vehicle while driving. Your first consideration while driving should be road safety.



### INTERFERENCE

All wireless devices may be susceptible to interference, which could affect performance.



### SWITCH OFF IN HOSPITALS

Follow any restrictions. Switch the device off near medical equipment.



### SWITCH OFF IN AIRCRAFT

Follow any restrictions. Wireless devices can cause interference in aircraft.



### SWITCH OFF WHEN REFUELING

Do not use the device at a refueling point. Do not use near fuel or chemicals.



### SWITCH OFF NEAR BLASTING

Follow any restrictions. Do not use the device where blasting is in progress.



### USE SENSIBLY

Use only in the positions as explained in the product documentation. Do not touch the antenna areas unnecessarily.



### QUALIFIED SERVICE

Only qualified personnel may install or repair this product.



### ENHANCEMENTS AND BATTERIES

Use only approved enhancements and batteries. Do not connect incompatible products.



### WATER-RESISTANCE

Your device is not water-resistant. Keep it dry.



### BACK-UP COPIES

Remember to make back-up copies or keep a written record of all important information stored in your device.



### CONNECTING TO OTHER DEVICES

When connecting to any other device, read its user guide for detailed safety instructions. Do not connect incompatible products.



### EMERGENCY CALLS

Ensure the phone function of the device is switched on and in service. Press the end key as many times as needed to clear the display and return to the standby mode. Enter the emergency number, then press the call key. Give your location. Do not end the call until given permission to do so.

## ■ About your device

The wireless device described in this guide is approved for use on the GSM 850/900/1800/1900, WCDMA 2100 network. Contact your service provider for more information about networks.

When using the features in this device, obey all laws and respect local customs, privacy and legitimate rights of others, including copyrights.

Copyright protections may prevent some images, music (including ringing tones), and other content from being copied, modified, transferred, or forwarded.

Your device supports internet connections and other methods of connectivity. Like computers, your device may be exposed to viruses, malicious messages and applications, and other harmful content. Exercise caution and open messages, accept connectivity requests, download content, and accept installations only from trustworthy sources. To increase the security of your devices, consider installing, using, and regularly updating antivirus software, firewall, and other related software on your device and any connected computer.



**Warning:** To use any features in this device, other than the alarm clock, the device must be switched on. Do not switch the device on when wireless device use may cause interference or danger.

## For your safety

The office applications support common features of Microsoft Word, PowerPoint, and Excel (Microsoft Office 2000, XP, and 2003). Not all file formats can be viewed or modified.

### ■ Network services

To use the phone you must have service from a wireless service provider. Many of the features require special network features. These features are not available on all networks; other networks may require that you make specific arrangements with your service provider before you can use the network services. Your service provider can give you instructions and explain what charges will apply. Some networks may have limitations that affect how you can use network services. For instance, some networks may not support all language-dependent characters and services.

Your service provider may have requested that certain features be disabled or not activated in your device. If so, these features will not appear on your device menu. Your device may also have a special configuration such as changes in menu names, menu order, and icons. Contact your service provider for more information.

This device supports WAP 2.0 protocols (HTTP and SSL) that run on TCP/IP protocols. Some features of this device, such as e-mail, browsing, multimedia messages, and content downloading, require network support for these technologies.

### ■ Enhancements, batteries, and chargers

Always switch the device off and disconnect the charger before removing the battery.

Check the model number of any charger before use with this device. This device is intended for use when supplied with power from the AC-4 and DC-4 chargers.



**Warning:** Use only batteries, chargers, and enhancements approved by Nokia for use with this particular model. The use of any other types may invalidate any approval or warranty, and may be dangerous.

For availability of approved enhancements, please check with your dealer. When you disconnect the power cord of any enhancement, grasp and pull the plug, not the cord.

## 1. Get started

---



**Note:** The actual invoice for calls and services from your service provider may vary, depending on network features, rounding off for billing, taxes, and so forth.

Model number: Nokia E90-1.

Hereinafter referred to as Nokia E90 Communicator.

### ■ Insert the SIM card and battery

For availability and information on using SIM card services, contact your SIM card vendor. This may be the service provider or other vendor.

Always switch the device off and disconnect the charger before removing the battery.

1. With the back of the device facing you, press the release button (1) and slide the back cover off (2).

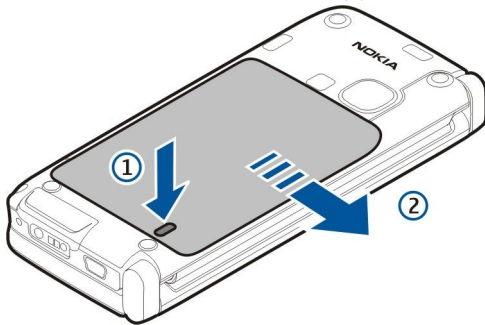

2. If the battery is inserted, lift the battery in the direction of the arrow to remove it.

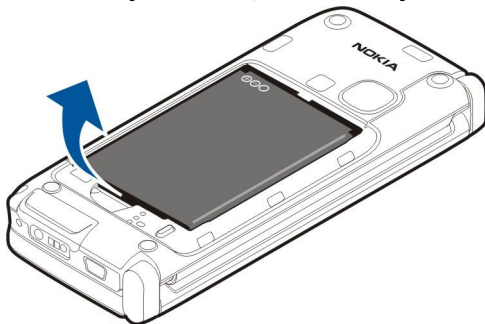

3. Insert the SIM card. Make sure that the contact area on the card is facing the connectors on the device and that the beveled corner is facing the bottom of the device.

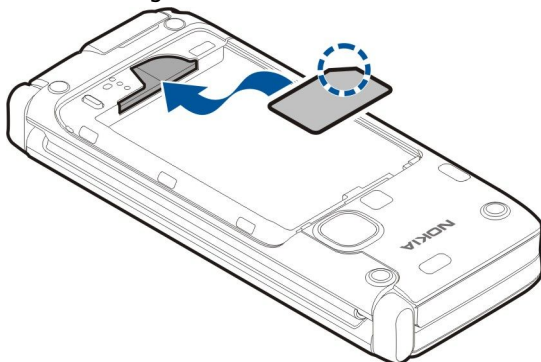

4. Insert the battery. Align the contacts of the battery with the corresponding connectors on the battery compartment and insert in the direction of the arrow.



## Get started

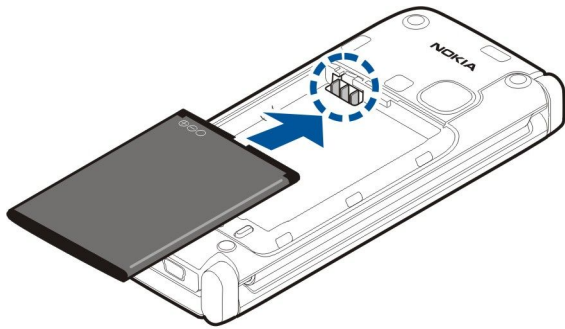

5. Place the hooks of the back cover to the slots.

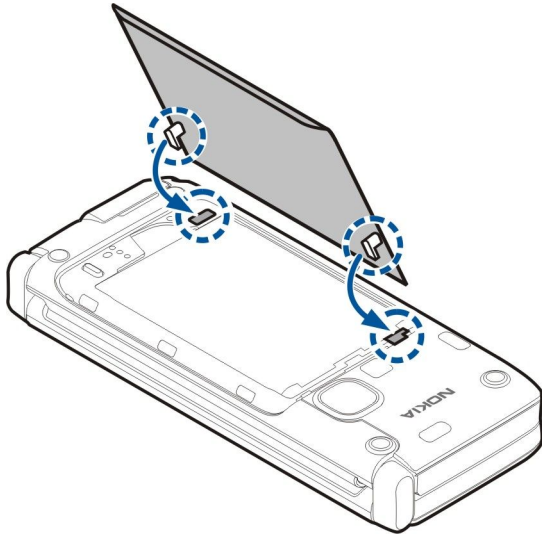

6. Slide the back cover back to place.

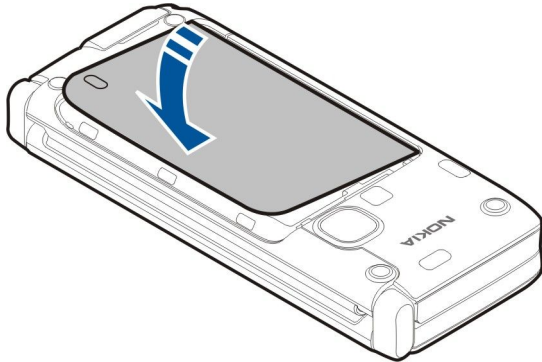

### ■ Insert the memory card

Use only compatible microSD cards approved by Nokia for use with this device. Nokia uses approved industry standards for memory cards, but some brands may not be fully compatible with this device. Incompatible cards may damage the card and the device and corrupt data stored on the card.

Use a memory card to save the memory on your device. You can also back up information from your device to the memory card. The sales package of your device may not include a memory card. Memory cards are available as separate enhancements.

[See "Memory" on page 18.](#)

1. Slide the cover of the memory card slot away from the device. The cover springs up.

## Get started

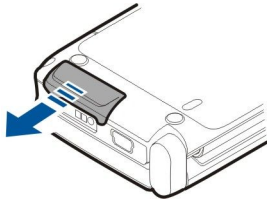

2. Insert the memory card in the slot with the contact area first. Make sure the contact area is towards the front cover of the device.

3.

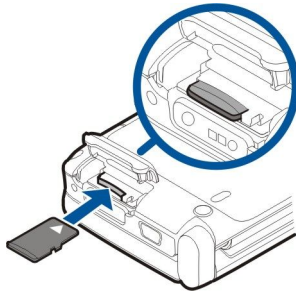

Push the card in. You hear a click when the card locks into place.

4. Close the cover.

### ■ Eject the memory card



**Important:** Do not remove the memory card in the middle of an operation when the card is being accessed. Removing the card in the middle of an operation may damage the memory card as well as the device, and data stored on the card may be corrupted.

1. Press the power key shortly, and select **Remove memory card**.
2. Slide the cover of the memory card slot away from the device. The cover springs up.
3. Press the end of the memory card to release it from the memory card slot.
4. Close the cover.

### ■ Charge the battery

1. Connect a compatible charger to a wall outlet.
2. Connect the power cord to the device. If the battery is completely discharged, it may take a while before the charging indicator starts scrolling.

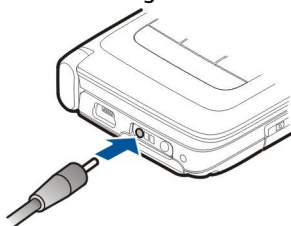

3. When the battery is fully charged, disconnect the charger from the device, then from the wall outlet.

Your battery has been precharged at the factory, but the charging levels may vary. To reach the full operation time, charge the battery until it has been fully charged according to the battery level indicator.



**Tip:** If you have old compatible Nokia chargers, you can use them with the Nokia E90 Communicator by attaching the CA-44 charger adapter to the old charger. The adapter is available as a separate enhancement.

### ■ Connect the headset



**Warning:** When you use the headset, your ability to hear outside sounds may be affected. Do not use the headset where it can endanger your safety.

Connect the compatible headset to the headset connector of your device.

## Get started

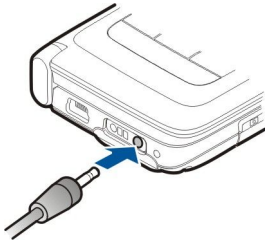

### ■ Keys and parts on the cover

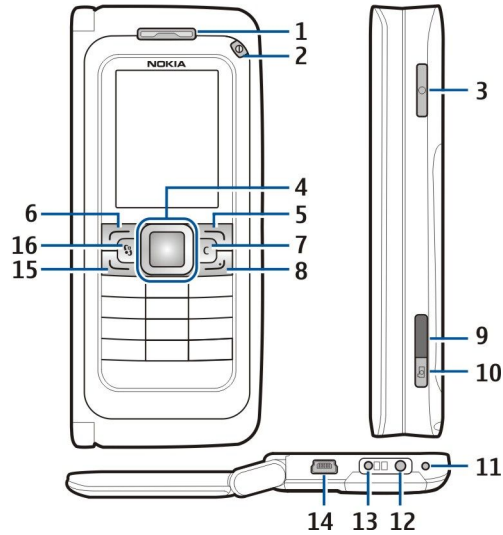

1 — Earpiece

2 — Power key

3 — Voice key

4 — Navi™ scroll key. Press the scroll key to enter a selection, to scroll left, right, up, and down on the display.

5 — Selection key. Press the selection key to perform the function shown above it on the display.

6 — Selection key

7 — Clear key

8 — End key. Press the end key to reject a call, end active calls and held calls, and with a long keypress, end data connections (GPRS, data call).

9 — Infrared port

10 — Capture key. Press the key to capture an image.

11 — Microphone

12 — Headset connector

13 — Charger connector

14 — Mini-USB port

15 — Call key

16 — Menu key. Press the menu key to access the applications installed in your device. Press and hold the menu key to access active applications.

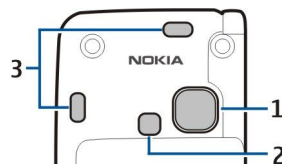

1 — Camera lens

2 — Camera flash

3 — Loudspeakers

The protective film on the display and the camera lens is removable.

## ■ Keys and parts on the communicator

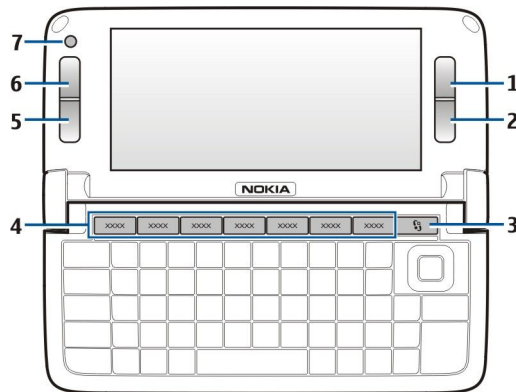



- 1 — Selection key
- 2 — Selection key
- 3 — Menu key
- 4 — Application keys
- 5 — End key
- 6 — Call key
- 7 — Camera (for video calls only)

 My own key. To configure the My own key to open an application, press the key. To change the selected application, press and hold the My own key. Your network operator may have assigned an application to the key, in which case you cannot change the application.

Chr +  Start an infrared connection.

Chr +  Start a Bluetooth connection.

Chr +  Increase the phone call volume.

Chr +  Decrease the phone call volume.

Chr +  Mute the phone call.

Chr +  Change the profile.

Chr +  adjust the display brightness.

 Switch on the backlight of the keyboard.

To find the type label, remove the battery cover and the battery.

## ■ Camera

The Nokia E90 Communicator has two cameras. The camera on the cover is used for capturing still images and recording videos. The camera on the communicator is used for video calls.

To capture an image, use the display as a viewfinder, hold the device horizontally, aim at your subject, and press the capture key half way down. The camera focuses on the subject. Then press the capture key all the way down.

To zoom the image before capturing, scroll left or right with the scroll key.

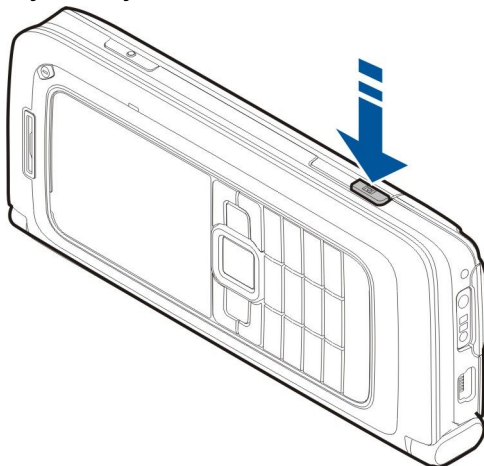

## ■ First start-up

1. Press and hold the power key.

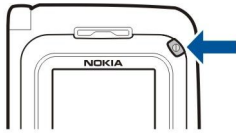

2. If the device asks for a PIN code or lock code, enter the code, and select **OK**.
3. When prompted, enter the current date, time, and the city in which you are located. To switch the time between a.m. and p.m., scroll up or down. To find your city, enter the first letters of the city name. It is important to select the correct city, because scheduled calendar entries may change if you change the city later and the new city is located on a different time zone.



**Tip:** When you switch the device on, it may recognize the SIM card provider and configure the correct text message, multimedia message, and GPRS settings automatically. If not, contact your service provider for the correct settings, or use the Settings wizard application.

When you switch the device off, the communicator part also switches off. To switch off the communications functions and use the communicator part only, press the power key briefly, and select **Offline**. The Offline profile prevents your device from accidentally switching on, sending or receiving messages, or using wireless LAN, Bluetooth, GPS, or FM radio; it also closes any internet connection that may be in operation when the profile is selected. The Offline profile does not prevent you from establishing a wireless LAN or Bluetooth connection at a later time, or from restarting the GPS or FM radio, so comply with any applicable safety requirements when establishing and using these features.









## ■ About the display

A small number of missing, discolored, or bright dots may appear on the screen. This is a characteristic of this type of display. Some displays may contain pixels or dots that remain on or off. This is normal, not a fault.

## ■ Display indicators

- The device is being used in a GSM network. The bar next to the icon indicates the signal strength of the network at your current location. The higher the bar, the stronger the signal.
- The battery charge level. The higher the bar, the stronger the charge in the battery.
- You have one or more unread messages in the Inbox folder in Messaging.
- You have received new e-mail in the remote mailbox.
- You have one or more missed phone calls.
- An alarm is active.
- You have selected the Silent profile, and the device does not ring for an incoming call or message.
- Bluetooth is active.
- An infrared connection is active. If the indicator blinks, your device is trying to connect to the other device, or the connection has been lost.
- A GPRS packet data connection is available.
- A GPRS packet data connection is active.
- A GPRS packet data connection is on hold.
- An EGPRS packet data connection is available.
- An EGPRS connection is active.
- An EGPRS packet data connection is on hold.
- You have set the device to scan for wireless LANs, and a wireless LAN is available.
- A wireless LAN connection is active in a network that does not have encryption.
- A wireless LAN connection is active in a network that has encryption.
- Your device is connected to a UMTS network.
- Your device is connected to a computer with a USB data cable.
- 1** and **2** Indicate the phone line that you have selected, if you have subscribed to two phone lines (network service).

## Get started

-  All calls are forwarded to another number.
-  A headset is connected to the device.
-  The connection to a headset with Bluetooth connectivity has been lost.
-  A hands-free car kit is connected to the device.
-  A loopset is connected to the device.
-  A text phone is connected to the device.
-  Your device is synchronizing.
-  You have an ongoing push-to-talk connection.

## ■ Antennas

Your device has internal antennas.



**Note:** As with any radio transmitting device, avoid touching an antenna unnecessarily when the antenna is in use. For example, avoid touching the cellular antenna during a phone call. Contact with a transmitting or receiving antenna affects the quality of the radio communication, may cause the device to operate at a higher power level than otherwise needed, and may reduce the battery life.



The picture shows the normal use of the device at the ear for voice calls.

## ■ Lock the keys

When the keypad lock is on, calls may be possible to the official emergency number programmed into your device.

Lock the keys to prevent the keys on the device from being accidentally pressed.

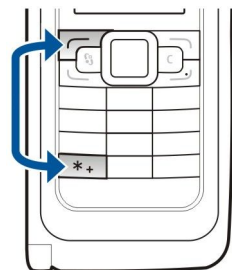

To lock the keys in the standby mode, press the left selection key and \*. To unlock, press the same keys again.



**Tip:** To lock the keys in the menu or in an open application, press the power key briefly, and select **Lock keypad**. To unlock, press the left selection key and \*.

To set the device to lock the keys automatically after a defined period, select  > **Tools** > **Settings** > **General** > **Security** > **Phone and SIM card** > **Keypad autolock period**.

## ■ Nokia support and contact information

Check [www.nokia.com/support](http://www.nokia.com/support) or your local Nokia web site for the latest version of this guide, additional information, downloads, and services related to your Nokia product.

On the web site, you can get information on the use of Nokia products and services. If you need to contact customer service, check the list of local Nokia contact centers at [www.nokia.com/customerservice](http://www.nokia.com/customerservice).

For maintenance services, check your nearest Nokia service center at [www.nokia.com/repair](http://www.nokia.com/repair).

## 2. Basic information about your device

---



### ■ Welcome

Select  > **Help** > **Welcome**.

When you switch on your device for the first time, the Welcome application opens. Select from the following:

- **Tutorial** provides information about your device and shows you how to use it. See "[Tutorial](#) " on page 19.
- **Transfer** enables you to transfer content, such as contacts and calendar entries, from a compatible Nokia device. See "[Transfer content between devices](#) " on page 20.
- **Settings wizard** helps you configure various settings. See "[Settings wizard](#) " on page 19.
- **Demo** contains a link to a presentation of the device features.
- **Operator** contains a link to your operator's home portal.

### ■ Switch from cover use to communicator

The applications and functions on the cover of your device are the same as on the communicator. If you use an application on the cover, and then open the communicator, the application shows on the communicator display in the same status as it was on the cover. The cover display switches off. If you switch back to the cover use, press  on the cover for a few seconds to open a list of active applications. Select the application you were using. If you want the application to continue automatically on the cover, select  > **Tools** > **Settings** > **General** > **Personalisation** > **Display** > **Cover display to Desk** > **Off**.

Some applications contain a preview pane when they are viewed from the communicator display. The preview pane is for viewing only; you cannot select or open items from it.

If you have an active phone or net call and switch from cover use to communicator, the loudspeaker activates automatically. When you close the communicator, the loudspeaker is muted and the audio comes through the earpiece. If you have an active video call and use the cover phone, the camera on the back of the device is used. When you open the communicator, the camera on the communicator is used.

### ■ Menu

The menu is a starting point from which you can open all applications in the device or on a memory card. The menu contains applications and folders, which are groups of similar applications.

All applications you install in the device yourself are by default saved in the **Installations** folder.

To open an application, scroll to it, and press the scroll key.

To view the applications in a list, select **Options** > **Change view** > **List view**. To return to the grid view, select **Options** > **Change view** > **Grid view**.

To view the memory consumption of different applications and data stored on the device or memory card and to check the amount of free memory, select **Options** > **Memory details**.

To create a new folder, select **Options** > **New folder**.

To rename a new folder, select **Options** > **Rename**.

To rearrange the folder, scroll to the application you want to move, and select **Options** > **Move**. A check mark is placed beside the application. Scroll to a new location, and select **OK**.

To move an application to a different folder, scroll to the application you want to move to another folder, and select **Options** > **Move to folder**, the new folder, and **OK**.

To download applications from the web, select **Options** > **Download applications**.

### ■ Common actions in several applications

You can find the following actions in several applications:

To change the profile, or switch off or lock the device, press the power key briefly.

If an application consists of several tabs, open a tab by scrolling right or left.

To save the settings that you have configured in an application, select **Back**.

To save a file, select **Options** > **Save**. There are different saving options depending on the application you use.

To send a file, select **Options** > **Send**. You can send a file in an e-mail or multimedia message, or using Bluetooth connectivity or infrared.

## Basic information about your device

To copy, press and hold the shift key, and select the text with the scroll key. Press and hold the shift key, and select **Copy**. To paste, scroll to where you want to paste the text, press and hold the shift key, and select **Paste**. This method may not work in applications that have their own copy and paste commands.

To select different items, such as messages, files, or contacts, scroll to the item you want to select. Select **Options** > **Mark/Unmark** > **Mark** to select one item or **Options** > **Mark/Unmark** > **Mark all** to select all items.



**Tip:** To select almost all items, first select **Options** > **Mark/Unmark** > **Mark all**, then select the items you do not want, and **Options** > **Mark/Unmark** > **Unmark**.

To select an object (for example, an attachment in a document) scroll to the object so that square markers appear on each side of the object.

## ■ Standby modes

Your device has two different standby modes: active standby mode and standby mode.

### Active standby

After you have switched on your device and it is ready for use, but you have not entered any characters or made other selections, the device is in the active standby mode. In the active standby mode, you can view different indicators such as network operator indicators or indicators for alarms, and applications you want to access fast.

To select applications that you want to access from active standby, select  > **Tools** > **Settings** > **General** > **Personalisation** > **Standby mode** > **Active standby apps..**

To change the functions of the selection keys in active standby, select  > **Tools** > **Settings** > **General** > **Personalisation** > **Standby mode** > **Shortcuts**.

To use the basic standby mode, select  > **Tools** > **Settings** > **General** > **Personalisation** > **Standby mode** > **Active standby** > **Off**.



**Tip:** To see the messages in a messaging folder such as Inbox or mailbox in the active standby mode, select  > **Messaging** > **Options** > **Settings** > **Other** and the folders in **Active standby mode**.

### Standby

In the basic standby mode, you can see your service provider, time, and different indicators, such as indicators for alarms.

To view the most recently dialed numbers, press the call key. Scroll to a number or name, and press the call key again to call the number.

To call your voice mailbox (network service), press and hold **1**.

To view calendar information, scroll right.

To write and send text messages, scroll left.

To change these shortcuts, select  > **Tools** > **Settings** > **General** > **Personalisation** > **Standby mode** > **Shortcuts**.

## ■ Write text with the cover keypad

### Traditional text input

**Abc** is shown on the top right of the display when you are writing text using traditional text input.

**ABC** and **abc** indicate the selected case. **Abc** indicates that the first letter of the sentence is written in uppercase and all the other letters are automatically written in lowercase. **123** indicates the number mode.

To write text with the keypad, press a number key **1–9** repeatedly until the desired character appears. There are more characters available for a number key than are printed on the key. If the next letter is located on the same key as the present one, wait until the cursor appears, and enter the letter.

To insert a number, press and hold the number key.

To switch between the letter and number mode, press and hold **#**.

To erase a character, press the clear key. Press and hold the clear key to clear more than one character.

To access the most common punctuation marks, press the **1** key. Press **1** repeatedly to reach the desired punctuation mark.

To add special characters, press **\***. Scroll to the desired character and press the scroll key.

To insert a space, press **0**. To move the cursor to the next line, press **0** three times.

To switch between the different character cases, press **#**.



## Predictive text input

1. To activate predictive text input, press **#** twice quickly. This activates predictive text input for all editors in the device. The indicator  is shown on the display.
2. To write the desired word, press **2–9**. Press each key only once for one letter.
3. When you have finished writing the word and it is correct, scroll right to confirm it, or press **0** to add a space.

If the word is not correct, press **\*** repeatedly to view the matching words the dictionary has found.

If the **?** character is shown after the word, the word you intended to write is not in the dictionary. To add a word to the dictionary, select **Spell**, enter the word (up to 32 letters) using traditional text input, and select **OK**. The word is added to the dictionary. When the dictionary is full, the new word replaces the oldest added word.

Write the first half of a compound word; to confirm it, scroll right. Write the last part of the compound word. To complete the compound word, press **0** to add a space.

To switch predictive text input off for all editors in the device, press **#** twice quickly.

## Change the writing language

When you are writing text, you can change the writing language. For example, if you press the **6** key repeatedly to reach a specific character, changing the writing language gives you access to characters in a different order.

If you are writing text using a non-Latin alphabet and want to write Latin characters, for example e-mail or web addresses, you may need to change the writing language. To change the writing language, select **Options** > **Writing language**, and a writing language that uses Latin characters.

## ■ Volume control



**Warning:** Do not hold the device near your ear when the loudspeaker is in use, because the volume may be extremely loud.

To adjust the earpiece volume during a phone call, scroll left or right.

To adjust the volume when using the loudspeaker, press **Chr + ▲** or **Chr + ▼** on the communicator.

To adjust the volume of Music player or the radio, scroll left or right.

## ■ Profiles



**Important:** In the offline profile you cannot make or receive any calls, or use other features that require cellular network coverage. Calls may still be possible to the official emergency number programmed into your device. To make calls, you must first activate the phone function by changing profiles. If the device has been locked, enter the lock code.

Select  > **Tools** > **Profiles**.

You can adjust and customize the ringing tones, alert tones, and other device tones for different events, environments, or caller groups. The profile currently in use is shown at the top of the display in the standby mode. However, if the active profile is **General**, only today's date is shown.

The **Offline** profile prevents your device from accidentally switching on, sending or receiving messages, or using wireless LAN, Bluetooth, GPS, or FM radio; it also closes any internet connection that may be in operation when the profile is selected. The Offline profile does not prevent you from establishing a wireless LAN or Bluetooth connection at a later time, or from restarting the GPS or FM radio, so comply with any applicable safety requirements when establishing and using these features.



**Tip:** To change the profile in any view, press the power key briefly. Select the profile you want to activate.

To create a new profile, select **Options** > **Create new**, and define the settings.

To customize a profile, select a profile and **Options** > **Personalise**.

To change a profile, select a profile and **Options** > **Activate**. If you select the Offline profile, you cannot send or receive messages.

To delete a profile that you created, select **Options** > **Delete profile**. You cannot delete the predefined profiles.

## Select ringing tones

To set a ringing tone, select **Options** > **Personalise** > **Ringing tone**. Select a ringing tone from the list, or select **Download sounds** to open a bookmark folder containing a list of bookmarks for downloading tones using the browser. Any downloaded tones are saved to Gallery.

To play the ringing tone for a selected contact group only, select **Options** > **Personalise** > **Alert for**, and select the desired group. Phone calls coming from outside that group have a silent alert.

To change the message tone, select **Options** > **Personalise** > **Message alert tone**.

## ■ Themes

Select  > **Tools** > **Themes**.

With Themes, you can change the look of the display of your device, such as the background image and colors.

To change the look of the display, open the **General** folder, select a theme and **Options** > **Set**.

To change the background image of the standby mode, select **Wallpaper** > **Image**, and select the desired image.

To change the screen saver, select **Power saver**, and select **Date and time** to display a date in the screen saver, **Text** to write a text for the screen saver, or **Animation file** to select an animation for the screen saver. When you have selected the desired screen saver, select **Options** > **Set**.

If you chose an animated screen saver, select **Options** > **Settings** to define the duration of the animation and the time-out period of the backlight.

To download a theme, select **Options** > **Download** > **Download themes**. Enter the link from which you want to download your theme. Once the theme is downloaded, you can preview, activate, or edit it.

To preview a theme, select **Options** > **Preview**.

To start using the selected theme, select **Options** > **Set**.

## ■ Memory

There are two types of memory into which you can save data or install applications: device memory and removable memory.

The device memory is a dynamic memory pool shared by many applications. The amount of internal memory available varies but cannot be increased past the maximum factory setting. Data stored on the device, such as software applications, images, and music, consume the device memory.

Removable memory is a data storage that is not built into your device, such as a SIM card or a memory card. A SIM card stores information about the network operator and contacts, for example. A memory card serves as an external storage for software applications, images, music, contacts, text, or any other form of electronic data. High-capacity memory cards are available.

To see how much memory is currently in use, how much free memory remains, and how much memory is consumed by each data type, select  > **Options** > **Memory details** > **Phone memory** or **Memory card**.



**Tip:** To ensure that you have adequate memory, delete or transfer data regularly to a memory card or computer.

## Memory card

Select  > **Tools** > **Memory**.

Your Nokia device supports the FAT16 and FAT32 file system for memory cards. If you use a memory card from another device or if you want to ensure compatibility of the memory card with your Nokia device, you may need to format the memory card with your Nokia device. Formatting a memory card destroys all data saved on the card.

You can insert and remove a memory card without removing the battery or powering off the device. Do not remove the memory card when the card is being accessed. Removing the card in the middle of an operation may damage the memory card as well as the device, and data stored on the card may be corrupted.

If you cannot use a memory card in your device, you may have the wrong type of memory card, the card may not be formatted for your device, or the card has a corrupted file system.

### MicroSD

Use only compatible microSD cards approved by Nokia for use with this device. Nokia uses approved industry standards for memory cards, but some brands may not be fully compatible with this device. Incompatible cards may damage the card and the device and corrupt data stored on the card.

This device uses a microSD memory card.

To ensure interoperability, use only compatible microSD cards with this device. Check the compatibility of a microSD card with its manufacturer or provider. Other memory cards than microSD cards are not compatible with this device.

Using an incompatible memory card may damage the memory card as well as the device, and data stored on the incompatible card may be corrupted.



### Use a memory card

To eject the memory card safely, select **Options** > **Remove memory card**.

To format a memory card for your device, select **Options** > **Format memory card**. When a memory card is formatted, all data on the card is lost permanently. Consult your retailer to find out if you must format the memory card before you can use it.

To change the name of the memory card, select **Options** > **Memory card name**.

## Basic information about your device

You can protect a memory card with a password to prevent unauthorized access. To set a password, select **Options** > **Set password**. The password can be up to eight characters long and is case-sensitive. The password is stored in your device. You do not need to enter it again while you use the memory card in the same device. If you use the memory card in another device, you are asked for the password. Not all memory cards support password protection.

To remove the memory card password, select **Options** > **Remove password**. When you remove the password, the data on the memory card is not protected against unauthorized use.

To open a locked memory card, select **Options** > **Unlock memory card**. Enter the password.

To check the memory consumption of applications and data, select **Options** > **Memory details**.

## ■ Help and tutorial

You can find answers to your questions while using the device even with no user guide present, because your device includes both a task-specific help and a tutorial.

### Device help

To read instructions for the current view of the open application, select **Options** > **Help**.

To browse the help topics and conduct searches, select  > **Help** > **Help**. You can select categories for which you want to see instructions. Select a category, such as Messaging, to see what instructions (help topics) are available. While you are reading the topic, scroll left or right to see the other topics in that category.

To switch between the application and help, press and hold .

### Tutorial

Select  > **Help** > **Tutorial**.

The tutorial provides you information about your device and shows you how to use it.

## ■ Settings wizard

Select  > **Tools** > **Sett. wizard**.

Settings wizard configures your device for operator (MMS, GPRS, and internet), e-mail, push-to-talk (network service), and video sharing (network service) settings based on your network operator information.

To use these services, you may have to contact your service provider to activate a data connection or other services.

If Settings wizard is not available from your wireless service provider, it may not appear in the menu of your device. For more information on the availability of Settings wizard, contact your service provider or dealer.

The availability of the different settings items in Settings wizard depends on the features of the device, SIM card, wireless service provider, and the availability of the data in the Settings wizard database.

To start the wizard, select **Start**. When you use the wizard for the first time, you are guided through the settings configuration. If there is no SIM card inserted, you need to select the home country of your wireless service provider, and your service provider. If the country or service provider suggested by the wizard is not correct, select the correct one from the list. If the settings configuration is interrupted, the settings are not defined. After closing the wizard, you can start to use the configured applications.

To access the main view of the Settings wizard after the wizard has finished the settings configuration, select **OK**.

In the main view, select **Options**, and from the following:

- **Operator** — Configure operator-specific settings such as, for example, MMS, Internet, WAP, and streaming settings.
- **E-mail settings** — Configure e-mail settings.
- **Push to talk** — Configure push-to-talk settings.
- **Video sharing** — Configure video sharing settings.

The available options may vary.

If you are not able to use Settings wizard, visit the Nokia phone settings web site at [www.nokia.com](http://www.nokia.com).

## ■ Nokia PC Suite

You can install Nokia PC Suite from the DVD or from the web. Nokia PC Suite can be used only with Windows 2000 and Windows XP. With Nokia PC Suite, you can make backups, synchronize your device with a compatible computer, move files between your device and a compatible computer, or use your device as a modem.

### 3. Transfer content between devices

---

Select  > **Tools** > **Transfer**.

You can transfer content, such as contacts, from a compatible Nokia device to your Nokia E90 Communicator using Bluetooth connectivity or infrared. The type of content that can be transferred depends on the device model. If the other device supports synchronization, you can also synchronize data between the other device and your Nokia E90 Communicator.

If you transfer data from your previous device, the device may require you to insert the SIM card. Your Nokia E90 Communicator does not need a SIM card when transferring data.

#### **Transfer data with Bluetooth**

1. In the information view, select **Continue**.
2. Select **Via Bluetooth**. Both devices must support the selected connection type.
3. Activate Bluetooth in your other device, and select **Continue** in your Nokia E90 Communicator to start searching for devices with active Bluetooth connectivity.
4. Select **Stop** in your Nokia E90 Communicator after it has found your other device.
5. Select your other device from the list. You are asked to enter a passcode (1 to 16 digits) on your Nokia E90 Communicator. The passcode is used only once to confirm this connection.
6. Enter the code on your Nokia E90 Communicator, and select **OK**. Enter the passcode on your other device, and select **OK**. The devices are now paired. [See "Pair devices" on page 45.](#)

For some phone models, the **Transfer data** application is sent to your other device as a message. To install **Transfer data** on your other device, open the message, and follow the instructions on the display.

7. From your Nokia E90 Communicator, select the content you want to transfer from your other device.

#### **Transfer data with infrared**

1. In the information view, select **Continue**.
2. Select **Via infrared**. Both devices must support the selected connection type.
3. Connect the two devices. [See "Infrared " on page 47.](#)
4. From your Nokia E90 Communicator, select the content you want to transfer from your other device, and select **OK**.

Content is copied from the memory of the other device to the corresponding location in your device. Copying time depends on the amount of data to be transferred. You can also cancel and continue later.

The necessary steps for data transfer may vary depending on your device, and whether you have interrupted data transfer earlier. The items that you can transfer vary depending on the other device.

### ■ Synchronize data with another device

If you have previously transferred data to your Nokia E90 Communicator, and your other device supports synchronization, you can use **Transfer data** to keep the data in the two devices up to date.

1. Select **Phones**.
2. Select the device from which you transferred data.
3. Select **Phones**. The devices start synchronizing using the same connection type that you selected when you originally transferred data. Only the data that you originally selected for data transfer is synchronized.

To modify the data transfer and synchronization settings, select **Phones**, then select the desired device, and **Edit**.

## 4. Telephone

---

### ■ Answer a call



**Note:** The actual invoice for calls and services from your service provider may vary, depending on network features, rounding off for billing, taxes, and so forth.

To make and receive calls, the device must be switched on, the device must have a valid SIM card installed, and you must be located in a service area of the cellular network.

To answer a call, press the call key.

To reject the call, press the end key.

To mute the ringing tone instead of answering a call, select **Silence**.

When you have an active call and the call waiting function is activated, press the call key to answer a new incoming call. The first call is put on hold. To end the active call, press the end key.

### ■ Make a call



**Important:** If the device has been locked, enter the lock code to activate the phone function. When the device is locked, calls may be possible to the official emergency number. Making an emergency call in the offline profile or when the device is locked requires that the device recognize the number to be an official emergency number. It is advisable to change the profile or unlock the device by entering the lock code before you make the emergency call.

To make a call, enter the phone number, including the area code, and press the call key.



**Tip:** For international calls, add the + character that replaces the international access code, and enter the country code, area code (omit the leading 0, if necessary), and phone number.

To end the call or cancel the call attempt, press the end key.

To make a call using the saved contacts, select **Contacts** in the standby mode. Enter the first letters of the name, scroll to the name, and press the call key. [See "Contacts " on page 35.](#)

To make a call using the log, press the call key to view up to 20 numbers that you last called or attempted to call. Scroll to the desired number or name, and press the call key. [See "Log " on page 25.](#)

To adjust the volume of an active call, scroll right or left.

To switch from a voice call to a video call, select **Options** > **Switch to video call**. The device ends the voice call and makes a video call to the recipient.

### ■ Make a conference call

1. To make a conference call, enter a participant's phone number, and press the call key.
2. When the participant answers, select **Options** > **New call**.
3. When you have made a phone call to all the participants, select **Options** > **Conference** to merge the calls into a conference call.

To mute the microphone of your device during the call, select **Options** > **Mute**.

To drop a participant from the conference call, scroll to the participant, and select **Options** > **Conference** > **Drop participant**.

To discuss privately with a conference call participant, scroll to the participant, and select **Options** > **Conference** > **Private**.

### ■ Video calls

To be able to make a video call, you need to be in the coverage of a UMTS network. For availability of and subscription to video call services, contact your network operator or service provider. While talking, you can see a real-time, two-way video between you and the recipient of the call, if the recipient has a compatible mobile phone. The video image captured by the camera in your device is shown to the video call recipient. A video call can only be made between two parties.



**Warning:** Do not hold the device near your ear when the loudspeaker is in use, because the volume may be extremely loud.

To make a video call, enter the phone number or select the recipient of the call from **Contacts**, and select **Options** > **Call** > **Video call**. When the video call starts, the camera on the back of the device is activated, if you use the cover phone. If the communicator is open, the camera on the communicator is activated. If the camera is already in use, video sending is disabled. If the recipient of the call does not want to send a video back to you, a still image is shown instead. You can define the still image in **Tools** > **Settings** > **Phone** > **Call** > **Image in video call**.

## Telephone

To disable the sending of audio, video, or video and audio, select **Options** > **Disable** > **Sending audio**, **Sending video**, or **Sending aud. & video**.

To use the loudspeaker for receiving audio, select **Options** > **Activate loudspeaker**. To mute the loudspeaker and use the earpiece, select **Options** > **Activate handset**.

To swap the places of images, select **Options** > **Change image order**.

To zoom the image on the display, select **Options** > **Zoom in** or **Zoom out**.

To end the video call and make a new voice call to the same recipient, select **Options** > **Switch to voice call**.

### ■ Video sharing

To share videos (network service) during a voice call, you need to configure the session initiation protocol settings at  > **Tools** > **Settings** > **Connection** > **SIP settings**. Contact your service provider for the correct settings.

You also need to set the network mode to **UMTS** at  > **Tools** > **Settings** > **Phone** > **Network**.

### Share a video

1. Make a phone call to the selected recipient. The recipient needs to have a compatible phone. You can start sharing a video once the phone call is established and your device has been registered to the SIP server.
2. To send live video or a video clip from your device, select **Options** > **Share video** > **Live video** or **Recorded clip**. To preview the clip, select **Options** > **Play**.
3. Select the recipient from Contacts, or enter the recipient's phone number or SIP address manually to send an invitation to the recipient. Sharing begins automatically when the recipient accepts the video sharing.
4. To end sharing the video, select **Stop**. The voice call continues normally.

### Receive a video sharing invitation

When you receive a video sharing invitation, a message is displayed showing the caller's name or SIP address.

To accept the invitation and begin the sharing session, select **Accept**.

To reject the invitation, select **Reject**. The voice call continues normally.

### ■ Net calls

Your device supports voice calls over the internet (net calls). Your device attempts emergency calls primarily over cellular networks. If an emergency call using cellular networks is not successful, your device attempts an emergency call through your net call provider. Due to the established nature of cellular telephony, you should use cellular networks for emergency calls, if possible. If you have cellular network coverage available, make sure that your cellular phone is switched on and ready to make calls before you attempt an emergency call. The capability for an emergency call using internet telephony depends on the availability of a WLAN network and your net call provider's implementation of emergency call capabilities. Contact your net call provider to check the internet telephony emergency call capability.

Select  > **Connectivity** > **Internet tel.**

With the net call service (network service), you can make and receive calls over the internet using the VoIP (voice over internet protocol) technology. Net calls can be established between computers, between mobile phones, and between a VoIP device and a traditional telephone. To make or receive a net call, your device must be within WLAN coverage, for example.

The availability of the net call service may vary according to your country or area.

### Create a net call profile

Before you can make net calls, you need to create a net call profile.

1. Select  > **Tools** > **Settings** > **Connection** > **SIP settings** > **Options** > **New SIP profile**, and enter the required information. Ensure that **Registration** is set to **Always on**. Contact your net call provider for the correct settings.
2. Select **Proxy server** > **Transport type** > **Auto**.
3. Select **Back** until you return to the **Connection** settings main view.
4. Select **Internet tel.** > **Options** > **New profile**. Enter a name for the profile, and select the SIP profile you just created.

To set the created profile to be used when connecting to the net call service automatically, select  > **Connectivity** > **Internet tel.** > **Preferred profile**.

To login to the net call service manually, select **Registration** > **When needed**, and **Transport type** > **UDP** or **TCP** in the SIP settings when creating a net call profile.

## Connect to the net call service

To make or receive a net call, your device must be connected to a net call service. If you have selected automatic login, your device automatically connects to the net call service. If you login to the service manually, choose an available network from the list, and select **Select**.

The list of networks is refreshed automatically every 15 seconds. To refresh the list manually, select **Options** > **Refresh**. Use this option, if your WLAN is not shown on the list.

To select a net call service for outgoing calls if the device is connected to more than one service, select **Options** > **Change service**.

To configure new services, select **Options** > **Configure service**. This option is shown only if there are services that have not been configured.

To save the network to which you are currently connected, select **Options** > **Save network**. The saved networks are marked with a star on the list of networks.

To connect to a net call service using a hidden WLAN, select **Options** > **Use hidden network**.

To end the connection to a net call service, select **Options** > **Disconnect from serv..**

## Make net calls

You can make a net call from all applications where you can make a regular voice call. For example in Contacts, scroll to the desired contact, and select **Call** > **Options** > **Internet call**.

To make a net call in the standby mode, enter the phone number or internet address, and press the call key.

To make a net call with the cover keypad to an address that does not start with a digit, press any number key when the device is in standby mode, then press **#** for a few seconds to clear the display and to switch the device from the number mode to the letter mode. Enter the address, and press the call key.

To set net call as the preferred call type for outgoing calls, select **☰** > **Connectivity** > **Internet tel.** > **Options** > **Settings** > **Default call type** > **Internet call**. When your device is connected to a net call service, all calls are made as net calls.

## ■ Speed dialing

Select **☰** > **Tools** > **Settings** > **Phone** > **Call** > **Speed dialing** > **On**.

Speed dialing allows you to make a call by pressing and holding a number key in the standby mode.

To assign a number key to a phone number, select **☰** > **Tools** > **Speed dial**. Scroll to the number key (2 - 9) on the display, and select **Options** > **Assign**. Select the desired number from Contacts.

To delete the phone number assigned to a number key, scroll to the speed dialing key, and select **Options** > **Remove**.

To modify a phone number assigned to a number key, scroll to the speed dialing key, and select **Options** > **Change**.

## ■ Call divert

Select **☰** > **Tools** > **Settings** > **Phone** > **Call divert**.

Divert incoming calls to your voice mailbox or to another phone number. For details, contact your service provider.

Select to divert voice, data, or fax calls, and select from the following options:

- **All voice calls, All data calls, or All fax calls** — Divert all incoming voice, data, or fax calls.
- **If busy** — Divert incoming calls when you have an active call.
- **If not answered** — Divert incoming calls after your device rings for a specified period of time. Select the time you let the device ring before diverting the call in the **Delay time:** list.
- **If out of reach** — Divert calls when the device is switched off or out of network coverage.
- **If not available** — Activate the last three settings at the same time. This option diverts calls if your device is busy, not answered, or out of reach.

To check the current diverting status, scroll to the diverting option, and select **Options** > **Check status**.

To stop diverting calls, scroll to the diverting option, and select **Options** > **Cancel**.

## Define the number for call diverting

Select **☰** > **Tools** > **Settings** > **Phone** > **Call divert**.

To divert calls to your voice mailbox, select a call type and a diverting option, then select **Options** > **Activate** > **To voice mailbox**.

## Telephone

To divert calls to another phone number, select a call type and a diverting option, then select **Options** > **Activate** > **Diverted to:**. Enter a number in the **Number:** field, or select **Find** to retrieve a number saved in Contacts.

### ■ Call barring

Select  > **Tools** > **Settings** > **Phone** > **Call barring**.

You can bar the calls that can be made or received with the device (network service). To change the settings, you need the barring password from your service provider. Call barring affects all calls, including data calls.

Call barring and call diverting cannot be active at the same time.

When calls are barred, calls may be possible to certain official emergency numbers.

To bar calls, select **Voice call barring** and select from the following options:

- **Outgoing calls** — Prevent making voice calls with your device.
- **Incoming calls** — Bar incoming calls.
- **International calls** — Prevent calling to foreign countries or regions.
- **Incoming calls when abroad** — Bar incoming calls when outside your home country.
- **International calls except to home country** — Prevent calls to foreign countries or regions, but allow calls to your home country.

To check the status of voice call barrings, select the barring option, and select **Options** > **Check status**.

To stop all voice call barrings, select a barring option, and select **Options** > **Cancel all barrings**.

### Net call barring

To bar net calls, select  > **Tools** > **Settings** > **Call barring** > **Internet call barring**.

To reject net calls from anonymous callers, select **Anonymous call barring** > **On**.

### Change the barring password

To change the password used for barring voice, fax, and data calls, select  > **Tools** > **Settings** > **Call barring** > **Voice call barring** > **Options** > **Edit barring password**. Enter the current code, then the new code twice. The barring password must be four digits long. For details, contact your service provider.

### ■ Send DTMF tones

You can send dual tone multi-frequency (DTMF) tones during an active call to control your voice mailbox or other automated phone services.

#### Send a DTMF tone sequence

1. Make a call, and wait until the other end answers.
2. Select  > **Options** > **Send DTMF**.
3. Enter the DTMF tone sequence, or select a predefined sequence.

#### Attach a DTMF tone sequence to a contact card

1. Select  > **Contacts**. Open a contact, and select **Options** > **Edit** > **Options** > **Add detail** > **DTMF**.
2. Enter the tone sequence. To insert a pause of about 2 seconds before or between DTMF tones, enter **p**. To set the device to send the DTMF tones only after you select **Send DTMF** during a call, enter **w**.
3. Select **Done**.

### ■ Voice mail

Select  > **Tools** > **Call mailbox**.

When you open the Voice mail application for the first time, you are asked to enter the number of your voice mailbox. To change the number, select **Options** > **Change number**.

To call your voice mail, select **Options** > **Call voice mailbox**.

To call your voice mailbox in the standby mode, press and hold **1**; or press **1** and then the call key.



## 5. Log

Select  > **Log**.

Log stores information about the communication history of the device. The device registers missed and received calls only if the network supports these functions, the device is switched on and within the network service area.

To view recently missed, received, and dialed calls, select **Recent calls**.



**Tip:** To open **Dialled numbers** in the standby modes, press the call key.

To view the approximate duration of calls to and from your device, select **Call duration**.

To view the amount of data transferred during packet data connections, select **Packet data**.

### ■ Monitor all communications

To monitor all voice calls, text messages, or data connections registered by the device, open the general log tab.

To view detailed information about a communication event, scroll to it, and press the scroll key.



**Tip:** Subevents, such as a text message sent in more than one part and packet data connections, are logged as one communication event. Connections to your mailbox, multimedia messaging center, or web pages are shown as packet data connections.

To add the phone number from a communication event to Contacts, select **Options** > **Save to Contacts**, and select a new or an existing contact.

To copy the number, for example to paste it to a text message, select **Options** > **Copy number**.

To view a single type of communication event or communication events with one other party, select **Options** > **Filter**, and select the desired filter.

To erase the contents of the log, recent calls register, and messaging delivery reports permanently, select **Options** > **Clear log**. To erase a single event, select the event and **Options** > **Delete**.

### ■ Call and send messages from Log

To call back a caller, select **Recent calls** and open **Missed calls**, **Received calls**, or **Dialled numbers**. Select the caller, and **Options** > **Call**.

To reply to a caller with a message, select **Recent calls** and open **Missed calls**, **Received calls**, or **Dialled numbers**. Select the caller, and select **Options** > **Create message**. You can send text messages and multimedia messages.

### ■ Log settings

Select **Options** > **Settings**.

To set the time for keeping all communication events in the log, select **Log duration**, and the time. If you select **No log**, all log contents are permanently deleted.

## 6. Messaging

Select  > **Messaging**.

In Messaging (network service), you can send and receive text messages, multimedia messages, and e-mail messages. You can also receive web service messages, cell broadcast messages, and special messages containing data, and send service commands. Before sending or receiving messages, you may need to do the following:

- Insert a valid SIM card in the device and be located in the service area of a cellular network.
- Verify that the network supports the messaging features you want to use and that they are activated on your SIM card.
- Define the internet access point (IAP) settings on the device. [See "Access points" on page 68.](#)
- Define the e-mail account settings on the device. [See "E-mail account settings" on page 33.](#)
- Define the text message settings on the device. [See "Text message settings" on page 33.](#)
- Define the multimedia message settings on the device. [See "Multimedia message settings" on page 33.](#)

The device may recognize the SIM card provider and automatically configure some of the message settings. If not, you may need to define the settings manually; or contact your service provider to configure the settings.

Messages and data received using Bluetooth connectivity or infrared are stored in the **Inbox** folder. E-mail messages are stored in **Mailbox**. Messages that you have been writing can be stored in the **Drafts** folder. Messages that are waiting to be sent are stored in the **Outbox** folder, and messages that have been sent, excluding Bluetooth and infrared messages, are stored in the **Sent** folder.



**Tip:** Messages are placed in Outbox, for example, when your device is outside network coverage. You can also schedule e-mail messages to be sent the next time you connect to your remote mailbox.

To request the network to send you a delivery report of the text messages and multimedia messages you have sent (network service), select **Options** > **Settings** > **Text message** or **Multimedia message** > **Receive report**. The reports are saved in the **Reports** folder.

### ■ Organize messages

To create a new folder to organize your messages, select **My folders** > **Options** > **New folder**.

To rename a folder, select **Options** > **Rename folder**. You can only rename folders that you have created.

To move a message to another folder, select **Options** > **Move to folder**, the folder, and **OK**.

To sort messages in a specific order, select **Options** > **Sort by**. You can sort the messages by **Date**, **Sender**, **Subject**, or **Message type**.

To view the properties of a message, select the message and **Options** > **Message details**.

### ■ Message reader

The message reader reads your received messages aloud.

To play a message, press and hold the left selection key when you receive a text message.

To start reading a message in Inbox or mailbox, select **Options** > **Listen**.

To start reading the next message in Inbox or mailbox, scroll down. To start reading the message again, scroll up. In the beginning of the message, scroll up to hear the previous message.

To adjust the volume, scroll left or right.

To pause the reading, press the left selection key briefly. To continue, press the left selection key briefly again.

To end the reading, press the end key.

To set the voice properties, select  > **Tools** > **Speech**.

### ■ Text messages

Select  > **Messaging**.

Your device supports the sending of text messages beyond the character limit for a single message. Longer messages are sent as a series of two or more messages. Your service provider may charge accordingly. Characters that use accents or other marks, and characters from some language options, take up more space, limiting the number of characters that can be sent in a single message.

1. To write a text message, select **New message** > **Text message**.

## Messaging

2. In the **To** field, enter a recipient's number, or press the scroll key to add a recipient from Contacts. If you enter more than one number, separate the numbers with a semicolon.
3. Enter the text of the message. To use a template, select **Options** > **Insert** > **Template**.
4. Select **Options** > **Send**.



**Note:** Your device may indicate that your message was sent to the message center number programmed into your device. Your device may not indicate whether the message is received at the intended destination. For more details about messaging services, contact your service provider.

### Sending options for text messages

To select a message center to send the message, select **Options** > **Sending options** > **Message centre in use**.

To have the network send you delivery reports on your messages (network service), select **Options** > **Sending options** > **Receive report** > **Yes**.

To define how long the message center resends your message (network service) if the first attempt fails, select **Options** > **Sending options** > **Message validity**. If the recipient cannot be reached within the validity period, the message is deleted from the message center.

To convert the message to another format, select **Options** > **Sending options** > **Message sent as** > **Text, Fax, Paging**, or **E-mail**. Change this option only if you are sure that your message center is able to convert text messages into these other formats. Contact your network operator.

### Text messages on the SIM card

Select **Options** > **SIM messages**.

Text messages may be stored on your SIM card. Before you can view SIM messages, you must copy the messages to a folder in the device. After copying the messages to a folder, you can view them in the folder or delete them from the SIM card.

1. Select **Options** > **Mark/Unmark** > **Mark** or **Mark all** to mark every message.
2. Select **Options** > **Copy**.
3. Select a folder and **OK** to begin copying.

To view SIM card messages, open the folder where you copied the messages, and open a message.

### Picture messages

Select  > **Messaging**.



**Note:** The picture message function can be used only if it is supported by your service provider. Only compatible devices that offer picture message features can receive and display picture messages. The appearance of a message may vary depending on the receiving device.

To view a picture message, open the message from the Inbox folder.

### Forward a picture message

1. To forward the message, select **Options** > **Forward**.
2. In the **To** field, enter a recipient's number, or press the scroll key to add a recipient from Contacts. If you enter more than one number, separate the numbers with a semicolon.
3. Enter the text of your message. The text can have 120 characters. To use a template, select **Options** > **Insert** > **Template**.
4. Select **Options** > **Send**.

## ■ Multimedia messages

Only devices that have compatible features can receive and display multimedia messages. The appearance of a message may vary depending on the receiving device.

Select  > **Messaging**.

A multimedia message (MMS) can contain text and objects such as images, sound clips, or video clips. Before you can send or receive multimedia messages on your device, you must define the multimedia message settings. Your device may have recognized the SIM card provider and automatically configured the multimedia message settings. If not, contact your service provider. [See "Multimedia message settings" on page 33.](#)

### Create and send multimedia messages

1. To create a new message, select **New message** > **Multimedia message**.
2. In the **To** field, enter a recipient's number or e-mail address, or press the scroll key to add a recipient from Contacts. If you enter more than one number or e-mail address, separate them with a semicolon.

## Messaging

3. In the **Subject** field, enter a subject for the message. To change the fields that are visible, select **Options** > **Address fields**.
4. Enter the text of the message, and select **Options** > **Insert object** to add media objects. You can add objects such as **Image**, **Sound clip**, or **Video clip**.  
The wireless network may limit the size of MMS messages. If the inserted picture exceeds this limit, the device may make it smaller so that it can be sent by MMS.
5. Each slide of your message can contain only one video or sound clip. To add more slides to your message, select **Options** > **Insert new** > **Slide**. To change the order of slides in your message, select **Options** > **Move**.
6. To preview a multimedia message before sending it, select **Options** > **Preview**.
7. Select **Options** > **Send**.

To delete an object from a multimedia message, select **Options** > **Remove**.

To set the sending options for the current multimedia message, select **Options** > **Sending options**.

### Create presentations

Creating multimedia presentations is not possible if the **MMS creation mode** setting is set to **Restricted**. To change the setting, select **Messaging** > **Options** > **Settings** > **Multimedia message** > **MMS creation mode** > **Free**.

1. To create a presentation, select **New message** > **Multimedia message**.
2. In the **To** field, enter a recipient's number or e-mail address, or press the scroll key to add a recipient from Contacts. If you enter more than one number or e-mail address, separate them with a semicolon.
3. Select **Options** > **Create presentation** and a presentation template. A template may define which media objects you can include in the presentation, where they appear, and which effects are displayed between images and slides.
4. Scroll to the text area and enter the text.
5. To insert images, sound, video, or notes in your presentation, scroll to the corresponding object area, and select **Options** > **Insert**.
6. To add slides, select **Insert** > **New slide**.

To preview the presentation, select **Options** > **Preview**. Multimedia presentations may only be viewed in compatible devices that support presentations. They may appear different in different devices.

To select the background color for the presentation and background images for different slides, select **Options** > **Background settings**.

To set effects between images or slides, select **Options** > **Effect settings**.

### Receive and reply to multimedia messages



**Important:** Exercise caution when opening messages. Multimedia message objects may contain malicious software or otherwise be harmful to your device or PC.



**Tip:** If you receive multimedia messages that contain objects unsupported by your device, you cannot open them. Try to send these objects to another device such as a computer, and open them there.

1. To reply to a multimedia message, open the message, and select **Options** > **Reply**.
2. Select **Options** and **To sender** to reply to the sender with a multimedia message, **Via text message** to reply with a text message, **Via audio message** to reply with an audio message, or **Via e-mail** to reply with an e-mail message.



**Tip:** To add recipients to your reply, select **Options** > **Add recipient** to select the recipients of the message from Contacts, or enter the recipients' phone numbers or e-mail addresses manually in the **To** field.

3. Enter the text of the message, and select **Options** > **Send**.

### View presentations

To view a presentation, open the multimedia message from the Inbox folder. Scroll to the presentation, and press the scroll key.

To pause the presentation, press either selection key.

To resume playing the presentation, select **Options** > **Continue**.

If the text or images are too large to fit on the display, select **Options** > **Activate scrolling**, and scroll to see the entire presentation.

To find phone numbers and e-mail or web addresses in the presentation, select **Options** > **Find**. You may use these numbers and addresses to make calls, send messages, or create bookmarks, for example.

### View media objects

Open a message from the Inbox folder, and select **Options** > **Objects**.

## Messaging

Media objects and message attachments may contain viruses or other harmful software. Do not open any objects or attachments unless you are sure of the trustworthiness of the sender.

To view or play a media object, press the scroll key.

To save a media object in its corresponding application, select **Options** > **Save**.

To send a media object to compatible devices, select **Options** > **Send**.

### View and save multimedia attachments

To view multimedia messages as complete presentations, open the message, and select **Options** > **Play presentation**.



**Tip:** To view or play a multimedia object in a multimedia message, select **View image**, **Play sound clip**, or **Play video clip**.

To view the name and size of an attachment, open the message, and select **Options** > **Objects**.

To save a multimedia object, select **Options** > **Objects**, the object, and **Options** > **Save**.

## E-mail messages

To receive and send e-mail, you must have a remote mailbox service. This service may be offered by an internet service provider, a network service provider, or your company. Your device is compliant with internet standards SMTP, IMAP4 (revision 1), and POP3, and with different vendor-specific e-mail solutions. Other e-mail providers may offer services with different settings or features than those described in this user guide. Contact your e-mail provider or service provider for more details.

Before you can send, receive, retrieve, reply to, and forward e-mail on your device, you must also do the following:

- Configure an internet access point (IAP). See "[Access points](#)" on page 68.
- Set up an e-mail account, and define the e-mail settings correctly. See "[E-mail account settings](#)" on page 33.

Follow the instructions from your remote mailbox and internet service providers. Contact your network and internet service providers or operator for the correct settings.

### Set up your e-mail with the mailbox guide

If you select **Messaging** > **Mailbox**, and have not set up your e-mail account, you are prompted to do so. To start setting up the e-mail account with the mailbox guide, select **Yes**.

1. To start entering the e-mail settings, select **Start**.
2. In **Mailbox type**, select **IMAP4** or **POP3**, and select **Next**.



**Tip:** POP3 is a version of the post office protocol that is used to store and retrieve e-mail or internet mail messages from a server. IMAP4 is a version of the internet message access protocol that lets you access and manage e-mail messages while the messages are still on the e-mail server. You can then choose which messages to download to your device.

3. In **My e-mail address**, enter your e-mail address. Select **Next**.
4. In **Incoming mail server**, enter the name of the remote server that receives your e-mail, and select **Next**.
5. In **Outgoing mail server**, enter the name of the remote server that sends your e-mail, and select **Next**. Depending on your mobile operator, you might have to use your mobile operator's outgoing mail server instead of your e-mail provider's.
6. In **Access point**, select the internet access point your device should use when it retrieves the e-mail. If you select **Always ask**, each time the device starts to retrieve e-mail, it asks which internet access point it should use. Select **Next**.
7. Enter a name for your new mailbox, and select **Finish**.

When you create a new mailbox, the name you give to the mailbox replaces **Mailbox** in the Messaging main view. You can have up to six mailboxes.

If you have defined several mailboxes, select one of them as your default mailbox. That mailbox is used every time you start composing a new e-mail message. To define the default mailbox, select **Options** > **Settings** > **E-mail** > **Default mailbox** and the mailbox.

### Connect to a remote mailbox

E-mail addressed to you is not automatically received by your device, but by your remote mailbox. To read your e-mail, you must first connect to the remote mailbox; then select the e-mail messages you wish to retrieve into your device.

1. To retrieve received e-mail messages to your device and view them, select your mailbox in the Messaging main view. When the device asks **Connect to mailbox?**, select **Yes**.
2. Select **Options** > **Retrieve e-mail** > **New** to retrieve new messages that you have neither read nor retrieved, **Selected** to retrieve only messages you select from the remote mailbox, or **All** to retrieve all messages not previously retrieved.

## Messaging

- To manage your e-mail offline to save in connection costs and work in conditions that do not allow a data connection, select **Options** > **Disconnect** to disconnect from the remote mailbox. Any changes you make in the remote mailbox folders while offline, take effect in your remote mailbox the next time you go online and synchronize.

### Read and reply to e-mail



**Important:** Exercise caution when opening messages. E-mail messages may contain malicious software or otherwise be harmful to your device or PC.

To read a received e-mail, open it from the mailbox.

To open an attachment, select **Options** > **Attachments**. Scroll to the attachment, and press the scroll key.

To reply only to the sender of an e-mail, select **Options** > **Reply** > **To sender**.

To reply to all recipients of an e-mail, select **Options** > **Reply** > **To all**.

To delete an attachment from an e-mail that you are sending, select the attachment and **Options** > **Remove**.



**Tip:** If you reply to an e-mail that contains attached files, the attachments are not included in the reply. If you forward the received e-mail, the attachments are included.

To set the message priority, select **Options** > **Sending options** > **Priority**.

To set the sending time for the e-mail message, select **Options** > **Sending options** > **Send message**. Select **Immediately**, or select **When conn. avail.** if you are working offline.

To call the sender of the e-mail message, if the sender can be found in Contacts, select **Options** > **Call**.

To reply to the sender of the e-mail with an audio message or multimedia message, select **Options** > **Create message**.

To forward an e-mail, select **Options** > **Forward**.

### Delete messages

To free up memory space on your device, regularly delete messages from the Inbox and Sent folders, and delete retrieved e-mail messages.

To delete e-mail from the device only, and keep the original on the server, select **Options** > **Delete** > **Phone (header remains)**.

To delete e-mail both from the device and the remote server, select **Options** > **Delete** > **Phone and server**.

To cancel the deleting, select **Options** > **Restore**.

### Subfolders in your remote e-mail

If you create subfolders in your IMAP4 mailboxes on a remote server, you can view and manage these folders with your device when you subscribe to them. You can only subscribe to folders in your IMAP4 mailboxes.

To view folders in your IMAP4 mailbox, establish a connection, and select **Options** > **E-mail settings** > **Retrieval settings** > **Folder subscriptions**.

To view a remote folder, select a folder and **Options** > **Subscribe**. Every time you go online, the subscribed folders are updated. This may take some time if the folders are large.

To update the list of folders, select a folder and **Options** > **Update folder list**.

### ■ Special messages

Select  > **Messaging**.

You can receive special messages that contain data, such as operator logos, ringing tones, bookmarks, or internet access or e-mail account settings.

To save the contents of these messages, select **Options** > **Save**.

### Send service commands

You can send a service request message (also known as a USSD command) to your service provider and request activation for certain network services. Contact your service provider for the service request text.

To send a service request message, select **Options** > **Service command**. Enter the service request text, and select **Options** > **Send**.

## Receive cell broadcast messages

To receive messages on various topics, such as weather or traffic conditions, from your service provider, select **Options** > **Cell broadcast** (network service). For available topics and relevant topic numbers, contact your service provider. Cell broadcast messages cannot be received in UMTS (3G) networks. A packet data connection may prevent cell broadcast reception.

## ■ Instant messaging

Select  > **Connectivity** > **IM**.

Instant messaging (IM) (network service) allows you to converse with other people using instant messages and join discussion forums (IM groups) with specific topics. Various service providers maintain IM servers that you can log in to after you register to an IM service. Service providers may differ in their support of features.

If IM is not available from your wireless service provider, it may not appear in the menu of your device. Contact your service provider for more information about signing up for IM services and costs of services. For more information on IM settings, contact your service provider.

You may receive the settings in a special text message from the service provider that offers the IM service. If not, enter the settings manually.

## Define IM settings

To define the IM application settings, select **Options** > **Settings** > **IM settings**. You can, for example, set your screen name and IM alert tones.

To converse with an IM user or users, and to view and edit your IM contacts, you must log into an instant messaging server. To add an IM server, select **Options** > **Settings** > **Server settings** > **Servers**. Ask your service provider for the correct settings. To set the server as the one to which your device automatically logs in, select **Options** > **Settings** > **Server settings** > **Default server**.

To define how your device connects to the IM server, select **Options** > **Settings** > **Server settings** > **IM login type**. To establish a connection between your device and the default server automatically, select **Automatic**. To automate the connection only when in your home network, select **Auto in home netw**. To connect to the server when you open the IM application, select **On app. start-up**. To connect to the server manually, select **Manual** and log into the server in the IM main view by selecting **Options** > **Log in**. Enter your user ID and password at the prompt. You can obtain the user name, password, and other settings to log in from your service provider when you register for the service.

## Start a conversation

Open **Conversations**.

To search for IM users and user IDs, select **IM contacts** > **Options** > **New IM contact** > **Search**. You can search by **User's name**, **User ID**, **Phone number**, and **E-mail address**.

To view a conversation, select a participant.

To continue the conversation, enter your message, and select **Options** > **Send**.

To return to the conversations list without closing the conversation, select **Back**. To close the conversation, select **Options** > **End conversation**.

To start a new conversation, select **Options** > **New conversation**. You can start a new conversation with a contact while you are inside an active conversation. However, you cannot have two active conversations with the same contact.

To insert an image to an instant message, select **Options** > **Send image**, and select the image you want to send.

To save a conversation participant to your IM contacts, select **Options** > **Add to IM contacts**.

To save a conversation, while in the conversation view, select **Options** > **Record chat**. The conversation is saved as a text file that can be opened and viewed in the Notes application.

## IM groups

Open **IM groups**. **IM groups** is available only if you are logged into an IM server, and the server supports IM groups.

To create an IM group, select **Options** > **Create new group**.

To join an IM group or to continue a group conversation, scroll to the group, and press the scroll key. Enter a message, and select **Options** > **Send**.

To join an IM group that is not on the list, but for which you know the group ID, select **Options** > **Join new group**.

To leave the IM group, select **Options** > **Leave IM group**.

## Messaging

To search for IM groups and group IDs, select **IM groups** > **Options** > **Search**. You can search by **Group name**, **Topic**, and **Members** (user ID).

To add an IM user to the group, select **Options** > **Add member**. Select a user from your IM contacts or enter the contact ID.

To remove a member from the IM group, select **Options** > **Remove**.

To provide members with editing rights to the group, select **Options** > **Add editor**. Select a user from your IM contacts or enter the ID of the user. IM users with editing rights can edit group settings and invite other users to join the group or ban them from the group.

To remove editing rights from a group member, select **Options** > **Remove**.

To prevent IM users from joining the group, select **Options** > **Add to banned list**. Select a user from your IM contacts or enter the ID of the user.

To allow a banned user to join the group, select **Options** > **Remove**.

### Block users

Select **IM contacts** > **Options** > **Blocking options** > **View blocked list**.

To find a blocked IM user, enter the first letters of the user's name. Matching names appear in a list.

To allow receiving messages from a blocked IM user, select **Options** > **Unblock**.

To prevent receiving messages from other IM users, select **Options** > **Block new contacts**. Select the IM user from your IM contacts, or enter the user ID.

### Cell broadcast

Select  > **Messaging** > **Options** > **Cell broadcast**.

With the cell broadcast network service, you can receive messages on various topics from your service provider, such as weather or traffic conditions in a particular region. For available topics and relevant topic numbers, contact your service provider. Cell broadcast messages cannot be received when the device is in the remote SIM mode. A packet data (GPRS) connection may prevent cell broadcast reception.

To receive cell broadcast messages, you may need to set the cell broadcast reception on. Select **Options** > **Settings** > **Reception** > **On**.

To view messages related to a topic, select the topic.

To receive messages related to a topic, select **Options** > **Subscribe**.



**Tip:** You can set important topics as hot topics. While the device is in the standby mode, you are notified when you receive a message related to a hot topic. Select a topic, and select **Options** > **Hotmark**.

To add, edit, or delete topics, select **Options** > **Topic**.

To cancel the reception of cell broadcast messages, to select the language of received messages, and to detect and display new cell broadcast topics, select **Options** > **Settings**.

### Service messages

Select  > **Messaging**.

Service messages are sent to your device by service providers. Service messages may contain notifications such as news headlines, services, or links through which the message content can be downloaded.

To define the service message settings, select **Options** > **Settings** > **Service message**.

To download the service or message content, select **Options** > **Download message**.

To view information about the sender, web address, expiration date, and other details of the message before downloading it, select **Options** > **Message details**.

### Messaging settings

Select  > **Messaging** > **Options** > **Settings**.

Fill in all fields marked with **Must be defined** or with a red asterisk.

Your device may recognize the SIM card provider and configure the correct text message, multimedia message, and GPRS settings automatically. If not, contact your service provider for the correct settings, order the settings from your service provider in a configuration message, or use the Settings wizard application.



## Text message settings

Select  > **Messaging** > **Options** > **Settings** > **Text message**.

Select from the following:

- **Message centres** — View the available message centers for your device.
- **Message centre in use** — Select a message center to send the message.
- **Character encoding** — Select **Reduced support** to use automatic character conversion to another encoding system when available.
- **Receive report** — Select **Yes** if you want the network to send you delivery reports on your messages (network service).
- **Message validity** — Select how long the message center resends your message if the first attempt fails (network service). If the recipient cannot be reached within the validity period, the message is deleted from the message center.
- **Message sent as** — Convert the message to another format, such as **Text**, **Fax**, **Paging** or **E-mail**. Change this option only if you are sure that your message center is able to convert text messages into these other formats. Contact your network operator.
- **Preferred connection** — Select the preferred method of connection when sending text messages from your device.
- **Reply via same centre** — Select whether you want the reply message to be sent using the same text message center number (network service).

## Multimedia message settings

Select  > **Messaging** > **Options** > **Settings** > **Multimedia message**.

Define the following settings:

- **Image size** — Select **Small** or **Large** to scale images in multimedia messages. Select **Original** to maintain the original image size.
- **MMS creation mode** — Select **Restricted** to have your device prevent you from including content in multimedia messages that may not be supported by the network or the receiving device. To receive warnings about including such content, select **Guided**. To create a multimedia message with no restrictions on attachment type, select **Free**. If you select **Restricted**, creating multimedia presentations is not possible.
- **Access point in use** — Select the default access point to connect to the multimedia message center. You may not be able to change the default access point if it is preset in your device by your service provider.
- **Multimedia retrieval** — Select **Always automatic** to receive multimedia messages always automatically, **Auto in home netw.** to receive notification of a new multimedia message that you can retrieve from the message center (for example, when you are traveling abroad and are outside your home network), **Manual** to retrieve multimedia messages from the message center manually, or **Off** to prevent receipt of any multimedia messages.
- **Allow anon. msgs.** — Select whether you want to receive messages from unknown senders.
- **Receive adverts** — Select whether you want to receive messages defined as advertisements.
- **Receive report** — Select **Yes** to have the status of the sent message to be shown in the log (network service). Receiving a delivery report of a multimedia message that has been sent to an e-mail address may not be possible.
- **Deny report sending** — Select **Yes** to not send delivery reports from your device for received multimedia messages.
- **Message validity** — Select how long the messaging center tries to send the message (network service). If the recipient of a message cannot be reached within the validity period, the message is removed from the multimedia messaging center. **Maximum time** is the maximum amount of time allowed by the network.

## E-mail account settings

Select  > **Messaging** > **Options** > **Settings** > **E-mail**.

If you try to edit mailbox settings but have not set up an e-mail account, the mailbox guide opens and helps you set up your e-mail account.

If you have defined a mailbox, scroll to it, and press the scroll key to edit the settings.

The settings available for editing may vary. Some settings may be preset by your service provider.

## User settings

Select the e-mail account, and **Options** > **Edit** > **User settings**, and define the following settings:

- **My name** — Enter a name to appear before your e-mail address when you send e-mail.
- **Reply-to** — Select whether you want replies to be redirected to a different address. Select **On**, and enter the e-mail address to which you want to direct the replies. You can only enter one address to which replies are directed.
- **Delete e-mails from** — Select whether you want to delete the e-mail messages only from the device or from both the device and the server. Select **Always ask** if you want to confirm from where the e-mail should be deleted every time you delete an e-mail.
- **Send message** — Select to send the e-mail immediately or when a connection is available.
- **Send copy to self** — Select whether you want to save a copy of the e-mail to your remote mailbox and to the address defined in **My e-mail address** in the **Outgoing e-mail** settings.
- **Include signature** — Select whether you want to attach a signature to your e-mail messages.

## Messaging

- **New e-mail alerts** — Select whether you want to be notified of a new received e-mail message with a tone and a note.

### Retrieval settings

Select the e-mail account, and **Options** > **Edit** > **Retrieval settings**, and define the following settings:

- **E-mail to retrieve** (for POP3 mailboxes only) — Select whether you want to retrieve only the e-mail header information such as sender, subject and date, e-mail, or e-mail with attachments.
- **Retrieval amount** — Select the number of e-mail messages you want to retrieve from the remote server to your mailbox.
- **IMAP4 folder path** (for IMAP4 mailboxes only) — Define the folder path for folders to be subscribed.
- **Folder subscriptions** (for IMAP4 mailboxes only) — Subscribe to other folders in the remote mailbox and retrieve content from those folders.

### Automatic retrieval settings

Select the e-mail account, select **Options** > **Edit** > **Automatic retrieval**, and define the following settings:

- **E-mail retrieval** — Select **Enabled** to retrieve new e-mail messages automatically from your remote mailbox, or **Only in home netw.** to retrieve new e-mail messages automatically from your remote mailbox only when you are in your home network and not, for example, traveling.
- **Retrieval days** — Select the days on which e-mail is retrieved to your device.
- **Retrieval hours** — Define the hours between which the e-mail is retrieved.
- **Retrieval interval** — Select the interval between retrieving new e-mail messages.
- **E-mail notifications** — Select whether you want to receive notifications on received e-mail.

### Cell broadcast settings

Select  > **Messaging** > **Options** > **Settings** > **Cell broadcast**.

Select from the following:

- **Reception** — Select **On** to receive cell broadcast messages.
- **Language** — Select the languages in which you want to receive cell broadcast messages.
- **Topic detection** — Select **On** to display new topics in the cell broadcast topics list.

### Other settings

Select  > **Messaging** > **Options** > **Settings** > **Other**.

Select from the following:

- **Save sent messages** — Select whether to store sent messages in the Sent folder.
- **Number of saved msgs.** — Enter the number of sent messages to save. When the limit is reached, the oldest message is deleted.
- **Memory in use** — Select where to save your messages. You can save messages to the memory card only if a memory card is inserted.
- **Folder view** — Define how you want the messages in the Inbox to be shown.

## 7. Contacts

Select  > **Contacts**.

You can save and update contact information, such as phone numbers, home addresses, or e-mail addresses of your contacts. You can add a personal ringing tone or a thumbnail image to a contact. You can also create contact groups, which allow you to send text messages or e-mail to many recipients at the same time. You can add received contact information (business cards) to Contacts. Contact information can only be sent to or received from compatible devices.

### ■ Copy contacts between SIM and device memory

If you already have contacts saved on your SIM card, you can copy them to the device memory.

To copy contacts from a SIM card to the device memory, select **Options** > **SIM contacts** > **SIM directory**. Mark the contacts to copy, or select **Options** > **Mark/Unmark** > **Mark all** to copy all contacts. Select **Options** > **Copy to Contacts**.

To copy contacts from the device memory to a SIM card, select **Options** > **Copy to SIM directory**. Mark the contacts you want to copy, or select **Options** > **Mark/Unmark** > **Mark all** to copy all contacts. Select **Options** > **Copy to SIM directory**.



**Tip:** If you have saved contacts on your previous device, you can use the Transfer application to copy them. See "[Transfer content between devices](#)" on page 20.

To search for a contact, enter the first letters of the name to the search field. A list of the contacts starting with the letters appear on the display.

### ■ Manage contacts

To add a contact, select **Options** > **New contact**.

To attach a small thumbnail image to a contact, select **Options** > **Edit** > **Options** > **Add thumbnail**. The thumbnail image is shown when the contact calls.

To listen to the voice tag assigned to the contact, select **Options** > **Play voice tag**.

To edit information in a contact, select **Options** > **Edit**.



**Tip:** You can also use Nokia PC Suite to add and edit contacts.

To send contact information, select **Options** > **Send**.

You can assign a default number or address to a contact so you can easily call or send a message to the default number or address, even if several numbers or addresses are saved to that contact. The default number is also used in voice dialing.

To change the default information for a contact, open the contact, and select **Options** > **Defaults**. Select the number or address you want to set as a default. The default number or address is underlined in the contact.

To add a contact to a group, select **Options** > **Add to group** (shown only if you have created a group).



**Tip:** To check to which groups a contact belongs, select **Options** > **Belongs to groups**.

To add a speed dial key to the contact's phone number, select **Options** > **Assign speed dial**.

To change the display order of the first and last names of your contacts, select **Options** > **Settings**, and **Last name First name**, or **First name Last name**.

### ■ Manage contact groups

You can create a contact group so that you can send text or e-mail messages to several recipients at the same time.

1. Open the contact groups tab, and select **Options** > **New group**.
2. Enter a name for the group, and select **OK**.
3. Open the group, and select **Options** > **Add members**.
4. Scroll to each contact you want to add to the group, and press the scroll key to mark it.
5. Select **OK** to add all marked contacts to the group.

To remove a contact from a contact group, scroll to the contact that you want to remove, and select **Options** > **Remove from group**.

To rename a group, select **Options** > **Rename**.

### ■ Add ringing tones for contacts

## Contacts

You can select a ringing tone for a contact or contact group. If the caller's phone number is sent with the incoming call and your device recognizes the number, the ringing tone plays when the contact calls you.

To select a ringing tone for a contact or contact group, open the contact or contact group, and select **Options** > **Ringing tone**. A list of ringing tones opens. Select the ringing tone you want to use.

To remove the assigned ringing tone, select **Default tone** from the list of ringing tones.

### ■ Business cards

You can send, receive, view, and save contacts as business cards in vCard or Nokia compact business card format.

To send a business card, select the contact from Contacts, select **Options** > **Send**, and the sending method. Enter the phone number or address, or add a recipient from Contacts. Select **Options** > **Send**. If you select text message as the sending method, business cards are sent without thumbnail images.

To view a received business card, select **Open** from the displayed notification, or open the message from the Inbox folder in the Messaging application.

To save a received business card, select **Options** > **Save business card**.

### ■ SIM directory and other SIM services

For availability and information on using SIM card services, contact your SIM card vendor. This may be the service provider or other vendor.

Select **Options** > **SIM contacts** > **SIM directory**.

In the SIM directory, you can see the names and numbers stored on the SIM card; add, edit, or copy numbers to contacts and make calls.

To add contacts to your SIM directory, select **Options** > **New SIM contact**. Enter the contact information and select **Done**.

To view the list of fixed dialing numbers, select **Options** > **SIM contacts** > **Fixed dial contacts**. This setting is only shown if supported by your SIM card.

To restrict calls from your device to selected phone numbers, select **Options** > **Activate fixed dialling**. You need your PIN2 code to activate and deactivate fixed dialling or edit your fixed dialling contacts. Contact your service provider if you do not have the code. To add new numbers to the fixed dialling list, select **Options** > **New SIM contact**. You need the PIN2 code for these functions. When you use fixed dialling, packet data connections are not possible, except when sending text messages over a packet data connection. In this case, the message center number and the recipient's phone number must be included on the fixed dialling list. When fixed dialling is activated, calls may be possible to the official emergency number programmed into your device.

To check the amount of free memory on your SIM card, select **Options** > **SIM card details**.

## 8. Calendar

Select  > **Calendar**.

You can create and view scheduled events and appointments. You can also set alarms for calendar entries.

You can synchronize your calendar data with a compatible computer using Nokia PC Suite. For information on synchronization, see the Nokia PC Suite guide.

### ■ Create calendar entries

You can create the following types of calendar entries:

- **Meeting** entries have a specific date and time.
- **Memo** entries are related to the whole day but not to a specific time of the day.
- **Anniversary** entries remind you of birthdays and special dates. They refer to a certain day but not a specific time of the day. Anniversary entries are repeated every year.
- **To-do** entries remind you of a task that has a due date but not a specific time of the day.

To create a calendar entry, scroll to a date, and select **Options** > **New entry**.

Select from the following:

- **Subject** or **Occasion** — Enter a description for the entry.
- **Location** — Enter the location information.
- **Start time** — Enter the start time.
- **End time** — Enter the end time.
- **Start date** or **Date** — Enter the start date or date the event occurs.
- **End date** — Enter the end date.
- **Alarm** — Set an alarm for meeting and anniversary entries. The alarm is displayed in the day view.
- **Repeat** — Specify whether you want the entry to be repeated and when. Define the repeat type, frequency, and possible ending date.
- **Synchronisation** — If you select **Private**, the calendar entry can be seen only by you and is not shown to others with online access to view the calendar. If you select **Public**, the calendar entry is shown to others who have access to view your calendar online. If you select **None**, the calendar entry is not copied to your computer when you synchronize.



**Tip:** Make sure you have selected the correct city in the Clock application, because scheduled calendar entries may change when the current city is changed and is on another time zone.

To edit an existing entry, scroll to the entry, and select **Options** > **Open**. Edit the details in the various fields.



**Tip:** When you edit or delete a repeated entry, choose how you want the change to take effect. If you select **All calendar entries deleted**, all repeated entries are deleted. If you select **Delete entry**, only the current entry is deleted.

To delete a calendar entry, select **Options** > **Delete**, and select **Before date** to delete all entries before the selected date, or **All entries** to delete all calendar entries from the device.

To send a calendar entry to a compatible device, select **Options** > **Send** > **Via text message**, **Via multimedia**, **Via e-mail**, **Via Bluetooth**, or **Via infrared**.

To add a received calendar entry, open the calendar entry attachment in the message, and select **Options** > **Save to Calendar**.

To respond to a received calendar entry, select **Accept**, **Tentative**, or **Decline**. If you accept the entry or mark it as tentative, the entry is added to your calendar. You can send a response to the sender of the calendar entry by e-mail. Select **Yes**, and the message is saved in Outbox to wait for sending.

### ■ To-do entries

You can create and maintain a task or list of tasks that must be done by a certain day. Each task can be assigned a due date, and an alarm.

#### Create a to-do entry

1. Scroll to a date, and select **Options** > **New entry** > **To-do**.
2. Enter the subject in the **Subject** field.
3. Enter the due date.
4. To set an alarm for the to-do entry, select **Alarm** > **On**. Enter the alarm time and date.
5. Specify a priority. The priority icons are (!) **High** and (-) **Low**. There is no icon for **Normal**.

## Calendar

6. Define how the entry is handled during synchronization in the **Synchronisation** field. Select **Private** to hide the entry from viewers if the calendar is available online, **Public** to make the entry visible to viewers if the calendar is available online, or **None** to not copy the entry to your computer when you synchronize.

To mark a task as completed, select **Options** > **Mark as done**.

To restore a task, select **Options** > **Mark as not done**.

### ■ Calendar views

To switch between the different calendar views, select **Options** in any calendar view. Select the type of view from the list.

To set the default calendar view, select **Options** > **Settings** > **Default view**, and the view you want.

To view a specific date, select **Options** > **Go to date**, and enter the date.

### Month view

In the month view, you can see the entire month at one time. Each row shows one week of dates. The active month is displayed, and the active day is either today or the last day that was viewed. The active day is marked with a colored square. Days that have scheduled events are marked with a small triangle in the bottom right corner. Scroll to switch between the days of the month and day entries.

### Week view

The week view shows the events for the selected week in seven day boxes. Today's date is marked with a colored square. Memos and anniversaries are placed before 8:00 a.m.

To change the starting day of the week, select **Options** > **Settings** > **Week starts on**.

### Day view

The day view shows the events for the selected day. Entries are grouped into time slots according to their starting time. To view the previous or next day, scroll left or right.

### To-do view

The to-do view shows the to-do items for the selected day.

To mark a task as completed, select **Options** > **Mark as done**.

To restore a task, select **Options** > **Mark as not done**.

### ■ Calendar settings

Select **Options** > **Settings**.

To change the alarm tone, select **Calendar alarm tone**.

To change the view displayed when you open the calendar, select **Default view**.

To change the first day of the week, select **Week starts on**.

To change the week view title, select **Week view title** and **Week number** or **Week dates**.

## 9. Clock

---

Select  > **Clock**.

In Clock, you can view your local time and time zone information, set and edit alarms, or modify date and time settings.

### ■ Alarm clock

Open the alarm clock tab.

To set an alarm, select **Options** > **Set alarm**, and enter the alarm time. When an alarm is active,  is displayed.

To switch off the alarm, select **Stop**, or to stop the alarm for 5 minutes, select **Snooze**. If the alarm time is reached while the device is switched off, the device switches itself on and starts sounding the alarm tone. If you select **Stop**, the device asks whether you want to activate the device for calls. Select **No** to switch off the device or **Yes** to make and receive calls. Do not select **Yes** when wireless phone use may cause interference or danger.

To change the alarm time, select **Options** > **Reset alarm**.

To remove the alarm, select **Options** > **Remove alarm**.

### ■ World clock

Open the world clock tab to check the time in different cities.

To add a city to the world clock view, select **Options** > **Add city**.

To change the city that determines the time and date in your device, select **Options** > **Set as current city**. The city is displayed in the Clock main view, and the time in your device is changed according to the city selected. Check that the time is correct and matches your time zone.

To remove a city from the list, select **Options** > **Remove**.

### ■ Clock settings

Select **Options** > **Settings**.

To change the time or date, select **Time** or **Date**.

To change the clock shown in the standby modes, select **Clock type** > **Analogue** or **Digital**.

To allow the mobile phone network to update the time, date, and time zone information to your device (network service), select **Network operator time** > **Auto-update**.

To change the alarm tone, select **Clock alarm tone**.

## 10. Office applications

---

Select  > **Office**.

Some office applications may not be available in all languages, in which case the application is in English in your device. Opening a large file may not be possible or it may take a while.

### ■ File manager

Select  > **Office** > **File mgr.**

With File manager, you can manage the contents and properties of files and folders on your device memory and memory card. You can open, create, move, copy, rename, send, and search for files and folders. Copyright protection may prevent sending some files.

Open the device tab or the memory card tab.

To select multiple files, scroll to each file, and select **Options** > **Mark/Unmark** > **Mark**.

To send the selected files, select **Options** > **Send**.

To move or copy files or folders to another folder, select **Options** > **Move to folder** or **Copy to folder**. Default folders such as Sound clips in Gallery cannot be moved.

To search for files, select **Options** > **Find**. Enter the search text, and press the scroll key. The folders and files whose names contain the search text are displayed.

To view information about the selected file, select **Options** > **Details**. To view additional information about the file online, select **Options** > **Additional details**.

### ■ Search

Select  > **Office** > **In-device search**.

With Search, you can search for information in your contacts, notes, calendar appointments, to-do notes, e-mail messages, multimedia messages, and text messages. You can also search for files by the file names in your device memory and memory card.

1. Select the content types you want to search in. To remove the selection, select it again. To include all content types in your search, select **Select all**. To remove all content types, select **Unselect all**.
2. Enter your search keywords or some part of the keywords. To include two words in your search, separate them with a space. You only find items that contain both keywords.
3. Select **Search**.

 **Tip:** Wildcards may help you find items. In your search keyword, use **?** to substitute a single character, and **\*** to substitute zero or more characters. If you use the **?** or **\*** wildcard, you must add **\*** to the beginning and end of a search keyword, for example **\*s?all\*** ("shall") or **\*dev\*ment\*** ("development").

To view the search results from your previous search, select **Options** > **Previous results**.

### ■ Calculator

Select  > **Office** > **Calculator**.

 **Note:** This calculator has limited accuracy and is designed for simple calculations.

To make a calculation, enter the first number of the calculation. Select a function such as add or subtract from the function map. Enter the second number of the calculation, and select **=**.

The calculator performs operations in the order they are entered. The result of the calculation remains in the editor field and can be used as the first number of a new calculation.

To save the results of a calculation, select **Options** > **Memory** > **Save**. The saved result replaces the previously stored result in the memory.

To retrieve the results of a calculation from the memory and use them in a calculation, select **Options** > **Memory** > **Recall**.

To view the last saved result, select **Options** > **Last result**. Exiting the Calculator application or switching off the device does not clear the memory. You can recall the last saved result the next time you open the Calculator application.

### ■ Nokia Team Suite

Select  > **Office** > **Teams**.



## Office applications

With Nokia Team Suite, you can create, edit, and delete teams, and send messages, view teams' web pages and communication history, and make phone calls to teams.

To create a new team, select **Options** > **Team** > **Create new**. Give a name for the team and enter the conference call service information, if needed. Then select the members for the team.

To select an action, first select the team to which you want to apply the action, then scroll right to the action bar, and select the desired action. If you do not want to apply the action to all team members, open the team, and select the desired members. Then select the action.

To find more actions than are shown on the action bar, select **Options** > **Actions**. The following actions are available:

- **Call** — Make a phone call to the team or selected team members. The team members are called one by one and put on hold until the calls can be merged into a conference call (network service). The maximum number of participants depends on the network service.
- **Create message** — Send a text message, a multimedia message, or an e-mail to the team or selected team members.
- **Call conference service** — Start a call to the conference call service (network service) defined for the selected team.
- **Communication log** — View the communication log for the team or selected team members.
- **Active notes** — Write and read notes related to the team.
- **Team search** — Search for content related to the team or selected team members.
- **Push to talk** — Communicate through push to talk (network service) with the team or selected team members.
- **Team Web bookmarks** — Open the bookmark folder that contains the team web pages.

To select which actions are shown in the action bar and in which order, select **Options** > **Settings** > **Action bar icons**.

### Edit teams

To add team members, select **Options** > **Members** > **Add**.

To remove team members, select **Options** > **Members** > **Remove**.

To edit the details of a member, select **Options** > **Members** > **Edit**.

To select whether to see the team members' pictures on the display, select **Options** > **Settings** > **View contact image**.

To see to which teams a member belongs, select **Options** > **Members** > **Belongs to teams**.

### ■ Quickoffice

Select  > **Office** > **Quickoffice**.

Quickoffice consists of Quickword for Microsoft Word, Quicksheet for Microsoft Excel, Quickpoint for Microsoft PowerPoint, and Quickmanager for purchasing software. You can create, view, and edit Microsoft Office 2000, XP, and 2003 documents (\*.doc, \*.xls and \*.ppt) and plain text files (\*.txt) with Quickoffice. All file formats or features are not supported. Apple Macintosh is not supported.

To open a file, press the scroll key. Quickoffice opens the file in the correct application.

### ■ Active notes

Select  > **Office** > **Active notes**.

Active notes allows you to create, edit, and view different kinds of notes, for example, meeting memos, hobby notes, or shopping lists. You can insert images, videos, and sound in the notes. You can link notes to other applications, such as Contacts, and send notes to others.

To create a note, start writing.

To create a folder, select **Options** > **Organise** > **New folder**.

To sort the notes by date and time, name, or size, select **Options** > **Organise** > **Sort**.

To move the notes or folders, select the desired item and **Options** > **Organise** > **Move to**. Select the folder to which you want to move the item.

To edit the settings, select **Options** > **Settings**.

To send the note using a short message, multimedia message, e-mail, Bluetooth, or infrared, select **Options** > **Send**.

### Create and edit notes

To edit a note, scroll to it, and press the scroll key.

To insert images, sound clips, video, business cards, web bookmarks, and files, select **Options** > **Insert object**.

To add new items to the note, select **Options** > **Insert new**. You can record sound and video clips, and capture images.

## Office applications

To add boldface, italics, or underlining to your text or change the font color, press and hold the shift key and use the scroll key to select the text. Then select **Options** > **Text**.

To link a note to a contact, select **Options** > **Link note to call** > **Add contacts**. You can see the note on the display of your device when making a call to or receiving a call from the contact.

### Settings for active notes

Select **Settings**.

To save notes to your device memory, select **Memory in use** > **Phone memory**. To save them to a memory card, select **Memory in use** > **Memory card**.

To change the layout of active notes, select **Change view** > **Grid**. To view the notes as a list, select **Change view** > **List**.

To see a note in the background when making or receiving phone calls, select **Show note during call** > **Yes**.



**Tip:** If you temporarily do not want to see the notes during phone calls, select **Show note during call** > **No**. This way you do not have to remove the links between notes and contact cards

### ■ Converter

Select  > **Office** > **Converter**.

The converter has limited accuracy, and rounding errors may occur.

### Convert measurements

1. Scroll to the **Type** field, and select **Options** > **Conversion type** to open a list of measures. Select the measure to use, and select **OK**.
2. Scroll to the first **Unit** field, and select **Options** > **Select unit**. Select the unit from which to convert, and select **OK**. Scroll to the next **Unit** field, and select the unit to which to convert.
3. Scroll to the first **Amount** field, and enter the value to convert. The other **Amount** field changes automatically to show the converted value.

### Set base currency and exchange rate



**Note:** When you change base currency, you must enter new exchange rates because all previously set exchange rates are cleared.

Before you can make currency conversions, you must choose a base currency and add exchange rates. The rate of the base currency is always 1. The base currency determines the conversion rates of the other currencies.

1. To set the rate of exchange for the unit of currency, scroll to the **Type** field, and select **Options** > **Currency rates**.
2. Scroll to the currency type and enter the exchange rate you would like to set per single unit of currency.
3. To change the base currency, scroll to the currency, and select **Options** > **Set as base currency**.
4. Select **Done** > **Yes** to save the changes.

After you have inserted all the necessary exchange rates, you can make currency conversions.

### ■ PDF reader

Select  > **Office** > **Adobe Reader**.

With PDF reader you can read PDF documents on the display of your device; search for text in the documents; modify settings, such as zoom levels and page views; and send PDF files using e-mail.

### ■ Zip manager

Select  > **Office**.

With Zip manager, you can create new archive files to store compressed ZIP formatted files; add single or multiple compressed files or directories to an archive; set, clear, or change the archive password for protected archives; and change settings, such as compression level, and file name encoding.

You can store the archive files on the device memory or on a memory card.

### ■ Print

You can print a message or file from the device, preview a print job, define page layout options, select a printer, or print to a file. You may not be able to print all messages, such as multimedia messages or other special messages.

## Office applications

To configure a printer for your device, select **☰** > **Office** > **Printers** > **Options** > **Add**. To set the printer as the default printer, select **Options** > **Set as default**.

Before you print, make sure your device is properly connected to the printer.

To print a message or a file, select **Options** > **Print**.

To print to a file, select **Options** > **Printing options** > **Print to file**, and determine the location for the file.

To change the printing options, select **Options** > **Printing options**. You can select the printer you want to use, the number of copies and the range of pages you want to print.

To change the page layout before printing, select **Options** > **Printing options** > **Page setup**. You can change the paper size and orientation, define the margins, and insert a header or a footer. The maximum length of the header and footer is 128 characters.

To preview a file or message before you print, select **Options** > **Printing options** > **Preview**.

### ■ Wireless keyboard

Select **☰** > **Office** > **Wireless keybd.**

Use the Wireless keyboard application to set up a Nokia Wireless Keyboard or other compatible wireless keyboard supporting the Bluetooth Human Interface Devices (HID) profile for use with your device.

#### Connect to the keyboard

1. Activate Bluetooth connectivity on your device: select **☰** > **Connectivity** > **Bluetooth** > **Bluetooth** > **On**.
2. Switch on the wireless keyboard.
3. Select **☰** > **Office** > **Wireless keybd.** > **Options** > **Find keyboard** to start searching for devices with Bluetooth connectivity.
4. Select the keyboard from the list, and press the scroll key to start the connection.
5. To pair the keyboard with your device, enter a passcode of your choice (1-9 digits) on the device and the same passcode on your keyboard.
6. If you are asked for a keyboard layout, select it from the list on your device.

When the name of the keyboard appears on the device display, its status changes to **Keyboard connected**, and the green indicator of your keyboard blinks slowly; the keyboard is ready for use.

#### Disconnect the keyboard

To close the Bluetooth connection but keep the Wireless keyboard application running, select **Options** > **Keyboard disconnected**.

To disconnect the keyboard and end the Bluetooth connection, select **☰** > **Connectivity** > **Bluetooth** > **Bluetooth** > **Off**.

For details on the operation and maintenance of your keyboard, see its user guide.

### ■ Notes

Select **☰** > **Office** > **Notes**.

You can create and send notes to other compatible devices, and save received plain text files (.txt format) to Notes.

To write a new note, select **Options** > **New note**.

To send the note to compatible devices, select **Options** > **Send**.

To view notes that are added as descriptions to calendar entries, open the calendar entry. Select **Description**.

To edit the note, select **Options** > **Edit**.

## 11. Connectivity

---

Your device offers several options to connect to the internet, a corporate intranet, or to another device or computer. Wireless methods include wireless LAN, Bluetooth, and infrared. Your device supports a wired solution with a USB (Universal Serial Bus) cable connection for Nokia PC Suite. Your device also allows you to communicate using net calls (Voice over IP), push to talk, instant messaging (chat), and modem-based connections.

### ■ Modem

Select  > **Connectivity** > **Modem**.

Together with a compatible computer, you can use your device as a modem to connect to the web.

#### **Before you can use your device as a modem**

- You need the appropriate data communications software on your computer.
- You must subscribe to the appropriate network services from your service provider or internet service provider.
- You must have the appropriate drivers installed on your computer. You must install drivers for the cable connection, and you may need to install or update Bluetooth or infrared drivers.

To connect the device to a compatible computer using infrared, press the scroll key. Make sure the infrared ports of the device and computer are directly facing each other with no obstacles between them.

To connect your device to a computer using Bluetooth wireless technology, initiate the connection from the computer. To activate Bluetooth in your device, select  > **Connectivity** > **Bluetooth** and select **Bluetooth** > **On**.

If you use a cable to connect your device to a computer, initiate the connection from the computer.

You may not be able to use some of the other communication features when the device is used as a modem.

### ■ Cable connection

Select  > **Connectivity** > **USB**.

Using a USB data cable, you can connect your device to a compatible computer. Connect the USB data cable to the USB connector of the device. To change the device type you normally connect to your device with the data cable, press the scroll key.

Install Nokia PC Suite to your computer before you use a cable connection, as Nokia PC Suite automatically installs the USB data cable driver to your computer. You can use the **Data transfer** mode without installing the USB data cable drivers.

To use your device as a modem, start Nokia PC Suite on your computer, connect the computer to your device with the data cable, and select **PC Suite**.

#### **Transfer data from a computer**

1. Make sure that you have selected USB as a connection type in the Manage connections settings in Nokia PC Suite.
2. Insert a memory card to your device and connect the device to a compatible computer with the USB data cable.
3. When the device asks which mode is used, select **Data transfer**. In this mode, you can see your device as a removable hard drive in your computer.
4. End the connection from the computer (for example, from an Unplug or Eject Hardware wizard in Windows) to avoid damaging the memory card.

### ■ Connection manager

Select  > **Connectivity** > **Conn. mgr.**.

To see the open data connections, select **Active data connections**. You can see the data calls, packet data connections, and WLAN connections.

To view detailed information about network connections, select a connection from the list and **Options** > **Details**. The type of information shown depends on the connection type.

To end the selected network connection, select **Options** > **Disconnect**.

To end all active network connections simultaneously, select **Options** > **Disconnect all**.

#### **Search for WLAN**

To search for WLANs available within range, select **Available WLAN networks**. The available WLAN view shows a list of WLANs within range, their network mode (infrastructure or ad-hoc), signal strength and network encryption indicators, and if your device has an active connection with the network.

To view the details of a network, scroll to it, and press the scroll key.

To create an internet access point for a network, select [Options](#) > [Define access point](#).

### ■ Bluetooth

This device is compliant with Bluetooth Specification 2.0 supporting the following profiles: Dial-up Networking Profile, Object Push Profile, File Transfer Profile, Handsfree Profile, Headset Profile, Basic Imaging Profile, SIM Access Profile, Generic Object Exchange Profile, Generic Access Profile, Generic Audio/Video Distribution Profile, Advanced Audio Distribution Profile, and Audio/Video Remote Control Profile. To ensure interoperability between other devices supporting Bluetooth technology, use Nokia approved enhancements for this model. Check with the manufacturers of other devices to determine their compatibility with this device.

Select  > [Connectivity](#) > [Bluetooth](#).

Bluetooth technology enables wireless connections between electronic devices within a range of 10 meters (33 feet). A Bluetooth connection can be used to send images, videos, text, business cards, calendar notes, or to connect wirelessly to devices using Bluetooth technology, such as computers.

Since devices using Bluetooth technology communicate using radio waves, your device and the other devices do not need to be in direct line-of-sight. The two devices only need to be within a maximum of 10 meters of each other, although the connection can be subject to interference from obstructions such as walls or other electronic devices.

Several Bluetooth connections can be active at a time. For example, if your device is connected to a headset, you can also transfer files to another compatible device at the same time.

### Send and receive data with Bluetooth

There may be restrictions on using Bluetooth technology in some locations. Check with your local authorities or service provider. Features using Bluetooth technology, or allowing such features to run in the background while using other features, increase the demand on battery power and reduce the battery life.

1. When you activate Bluetooth for the first time, you are asked to give a name to your device. Give your device a unique name to make it easy to recognize if there are several Bluetooth devices in the vicinity.
2. Select [Bluetooth](#) > [On](#).
3. Select [My phone's visibility](#) > [Shown to all](#) or [Define period](#). If you select [Define period](#), you need to define the time during which your device is visible to others. Your device and the name you entered can now be seen by other users with devices using Bluetooth technology.
4. Open the application where the item you want to send is stored.
5. Select the item, and select [Options](#) > [Send](#) > [Via Bluetooth](#). The device searches for other devices using Bluetooth technology within range and lists them.



**Tip:** If you have sent data using Bluetooth before, a list of the previous search results is displayed. To search for more Bluetooth devices, select [More devices](#).

6. Select the device with which you want to connect. If the other device requires pairing before data can be transmitted, you are asked to enter a passcode.

When the connection has been established, [Sending data](#) is shown.

The Sent folder in the Messaging application does not store messages sent using Bluetooth connectivity.

To receive data using Bluetooth, select [Bluetooth](#) > [On](#) and [My phone's visibility](#) > [Shown to all](#) to receive data from a non-paired device or [Hidden](#) to receive data from a paired device only. When you receive data through Bluetooth, a tone sounds, and you are asked if you want to accept the message in which the data is included. If you accept, the message is placed in the Inbox folder in the Messaging application.



**Tip:** You can access the files in the device or on the memory card using a compatible accessory that supports the File Transfer Profile Client service (for example, a laptop computer).

A Bluetooth connection is disconnected automatically after sending or receiving data. Only Nokia PC Suite and some enhancements such as headsets may maintain a connection even if not actively used.

### Pair devices

Open the paired devices tab.

Before pairing, create your own passcode (1-16 digits), and agree with the user of the other device to use the same code. Devices that do not have a user interface have a fixed passcode. You need the passcode only when you connect the devices for the first time. After pairing, it is possible to authorize the connection. Pairing and authorizing the connection makes connecting quicker and easier, as you do not have to accept the connection between paired devices every time you establish a connection.

The passcode for remote SIM access must have 16 digits.

## Connectivity

1. Select **Options** > **New paired device**. The device starts to search for Bluetooth devices within range. If you have sent data using Bluetooth before, a list of the previous search results is displayed. To search for more Bluetooth devices, select **More devices**.
2. Select the device with which you want to pair, and enter the passcode. The same passcode must be entered to the other device as well.
3. Select **Yes** to make the connection between your device and the other device automatic, or **No** to confirm the connection manually every time a connection attempt is made. After pairing, the device is saved to the paired devices page.

To give a nickname to the paired device, select **Options** > **Assign short name**. The nickname is only displayed in your device.

To delete a pairing, select the device whose pairing you want to delete and **Options** > **Delete**. To delete all pairings, select **Options** > **Delete all**. If you are currently connected to a device and cancel the pairing with that device, pairing is removed immediately, and the connection is ended.

To allow a paired device to connect automatically to your device, select **Set as authorised**. Connections between your device and the other device can be made without your knowledge. No separate acceptance or authorization is needed. Use this status for your own devices, such as your compatible headset or computer, or devices that belong to someone you trust. If you want to accept connection requests from the other device separately every time, select **Set as unauthorised**.

To use a Bluetooth audio enhancement such as a Bluetooth handsfree or headset, you need to pair your device with the enhancement. See the enhancement user guide for the passcode and further instructions. To connect to the audio enhancement, switch on the enhancement. Some audio enhancements connect automatically to your device. Otherwise open the paired devices tab, scroll to the enhancement, and select **Options** > **Connect to audio device**.

### Security tips

When you are not using Bluetooth connectivity, select **Bluetooth** > **Off** or **My phone's visibility** > **Hidden**.

Do not pair with an unknown device.

### Bluetooth connectivity indicators

 Bluetooth is active.

 When the icon is blinking, your device is trying to connect to the other device. When the icon is shown continuously, the Bluetooth connection is active.

### ■ SIM access profile

When the wireless device is in the remote SIM mode, you can only use a compatible connected enhancement, such as a car kit, to make or receive calls. Your wireless device will not make any calls, except to the emergency numbers programmed into your device, while in this mode. To make calls from your device, you must first leave the remote SIM mode. If the device has been locked, enter the lock code to unlock it first.

With the SIM access profile, you can access the SIM card of your device from a compatible car kit device. This way, you do not need a separate SIM card to access SIM card data and connect to the GSM network.

To use the SIM access profile, you need the following:

- Compatible car kit device that supports Bluetooth wireless technology
- Valid SIM card in your Nokia E90 Communicator

For more information about car kit devices and compatibility with your Nokia E90 Communicator, see [www.nokia.com](http://www.nokia.com) and your car kit user guide.

#### Use the SIM access profile

1. Select  > **Connectivity** > **Bluetooth** > **Remote SIM mode** > **On**.
2. Activate Bluetooth in the car kit device.
3. Use your car kit device to start a search for compatible devices. For instructions, see the user guide of your car kit device.
4. Select your Nokia E90 Communicator from the list of compatible devices.
5. To pair the devices, enter the Bluetooth passcode shown on the display of the car kit device to your Nokia E90 Communicator.



**Tip:** If you have already accessed the SIM card from the car kit with the active user profile, the car kit searches automatically for a device with the SIM card. If it finds your Nokia E90 Communicator, and automatic authorization is activated, the car kit automatically connects to the GSM network when you switch on the car ignition.

When you activate the remote SIM access profile, you can use applications on your device that do not need network or SIM services.

To make connections between your device and the car kit device without separate acceptance or authorization, select  > **Connectivity** > **Bluetooth**, and open the paired devices tab. Scroll to the car kit device, press the scroll key, and enter the Bluetooth

## Connectivity

passcode. When the device asks to make the connection automatic, select **Yes**. If you select **No**, connection requests from this device must be accepted separately every time.

To end the remote SIM access connection from your device, select  > **Connectivity** > **Bluetooth** > **Remote SIM mode** > **Off**.

### ■ Infrared

Do not point the infrared (IR) beam at anyone's eye or allow it to interfere with other IR devices. This device is a Class 1 laser product.

Use infrared to connect two devices and transfer data between them. With infrared, you can transfer data such as business cards, calendar notes, and media files with a compatible device.

#### Send and receive data

1. Ensure that the infrared ports of the devices face each other. The positioning of the devices is more important than the angle or distance.
2. Select  > **Connectivity** > **Infrared** to switch on infrared on your device.
3. Switch on infrared on the other device and wait a few seconds until the infrared connection is established.
4. Locate the desired file in an application or File manager, and select **Options** > **Send** > **Via infrared**.

If the data transfer is not started within 1 minute after the activation of the infrared port, the connection is cancelled and must be started again.

All items received through infrared are placed in the Inbox folder in Messaging.

Positioning the devices away from each other breaks the connection, but the infrared light beam remains active on your device until it deactivates.

### ■ Internet access points

An access point is where your device connects to a network. To use e-mail and multimedia services or to connect to the internet and browse web pages, you must first define the internet access point for these services. You may need to set up several internet access points, depending on the sites you want to access. For example, browsing the web may require one access point, and accessing your company intranet may require another. To connect to the internet over GPRS, your device may have predefined, default internet access point settings.

When you switch on your device for the first time, the access points may be configured automatically based on the service provider information in your SIM card. You can also receive the access point settings in a message from your service provider. This might reduce the number of settings you need to enter yourself.

The available options may vary. Some or all access points may be preset for your device by your service provider. You may not be able to add, edit, or delete access points. Contact your service provider and e-mail service provider for more information on access points and their settings.

#### Set up an internet access point for data calls

1. Select  > **Tools** > **Settings** > **Connection** > **Access points**.
2. Select **Options** > **New access point** to create a new access point, or select an existing access point from the list and then **Options** > **Duplicate access point** to use the access point as a basis for the new one.
3. Define the following settings.
  - **Connection name** — Enter a descriptive name for the connection.
  - **Data bearer** — Select **Data call** or **High speed (GSM)**.
  - **Dial-up number** — Enter the modem telephone number of the access point. Use + before international numbers.
  - **User name** — Enter your user name if required by the service provider. User names are often case-sensitive and provided by your service provider.
  - **Prompt password** — Select **Yes** to enter your password each time you log into a server or **No** to save the password in your device memory and automate the login.
  - **Password** — Enter your password if required by the service provider. The password is often case-sensitive and provided by the service provider.
  - **Authentication** — Select **Secure** to send your password always encrypted or **Normal** to send your password encrypted when possible.
  - **Homepage** — Enter the web address of the page you want to display as the home page when you use this access point.
  - **Data call type** — Select **Analogue**, **ISDN v.110**, or **ISDN v.120**.
  - **Maximum data speed** — Select the limit to apply to the transfer speed. If you select **Automatic**, the data transfer rate is determined by the network and may be affected by network traffic. Some service providers may charge more for higher data rates.

4. After defining the basic settings, select **Options** > **Advanced settings** to define the advanced settings or **Back** to save the settings and exit.

### Advanced internet access point settings for data calls

After setting up a basic internet access point for **Data call** or **High speed (GSM)**, select **Options** > **Advanced settings**, and define the following advanced settings:

- **IPv4 settings** — Enter the device IP and name server addresses for the IPv4 internet protocol.
- **IPv6 settings** — Enter the device IP and name server addresses for the IPv6 internet protocol.
- **Proxy server address** — Enter the proxy server address.
- **Proxy port number** — Enter the proxy server port number. Proxy servers are intermediate servers between a browsing service and its users, which are used by some service providers. These servers may provide additional security and speed up access to the service.
- **Use callback** — Select **Yes** if you have a service that dials back to your device when you establish an internet connection.
- **Callback type** — Select **Use server number** or **Use other number**, according to instructions from your service provider.
- **Callback number** — Enter your device data call phone number, which the callback server uses.
- **Use PPP compression** — Select **Yes** to speed up the data transfer, if it is supported by the remote PPP server.
- **Use login script** — Select **Yes**, if your internet service provider requires a login script, or if you want to automate your login. A login script is a sequence of instructions that the system follows during the login process.
- **Login script** — Enter the login script. This setting is available only if you have selected **Use login script** > **Yes**.
- **Modem initialisat. string** — Enter a command string for the connection setup, if required by your service provider.

### Set up an internet access point for packet data (GPRS)

1. Select **Tools** > **Settings** > **Connection** > **Access points**.
2. Select **Options** > **New access point** to create a new access point, or select an existing access point from the list and then **Options** > **Duplicate access point** to use the access point as a basis for the new one.
3. Define the following settings.
  - **Connection name** — Enter a descriptive name for the connection.
  - **Data bearer** — Select **Packet data**.
  - **Access point name** — Enter the name for the access point. The name is usually provided by your service provider.
  - **User name** — Enter your user name if required by the service provider. User names are often case-sensitive and provided by your service provider.
  - **Prompt password** — Select **Yes** to enter your password each time you log into a server or **No** to save the password in your device memory and automate the login.
  - **Password** — Enter your password if required by the service provider. The password is often case-sensitive and provided by the service provider.
  - **Authentication** — Select **Secure** to send your password always encrypted, or **Normal** to send your password encrypted when possible.
  - **Homepage** — Enter the web address of the page you want to display as the home page when you use this access point.
4. After defining the settings, select **Options** > **Advanced settings** to define the advanced settings or **Back** to save the settings and exit.

### Advanced internet access point settings for packet data (GPRS)

After setting up a basic internet access point for packet data (GPRS), select **Options** > **Advanced settings**, and define the following advanced settings:

- **Network type** — Select **IPv4** or **IPv6** as the internet protocol type. The internet protocol defines how data is transferred to and from your device.
- **Phone IP address** — Enter the IP address of your device. Select **Automatic** to have the network provide the device IP address. This setting is shown only if you select **Network type** > **IPv4**.
- **DNS address** — Enter the IP addresses of the **Primary DNS address** and **Secondary DNS address** if required by your service provider. Otherwise, the name server addresses are provided automatically.
- **Proxy server address** — Enter the address of the proxy server. Proxy servers are intermediate servers used by some service providers between a browsing service and its users. These servers may provide additional security and speed up access to the service.



## 12. Wireless local area network

Some places, like France, have restrictions on the use of wireless LAN. Check with your local authorities for more information. Your device can detect and connect to a wireless local area network (WLAN). To use WLAN, a network must be available in the location and your device must be connected to it.

### ■ See WLAN availability

To have your device show WLAN availability, select  > **Tools** > **Settings** > **Connection** > **Wireless LAN** > **Show WLAN availability**.

If WLAN is available,  is shown on the display.



**Tip:** You can also scan for networks in range.

### ■ WLAN connections



**Important:** Always enable one of the available encryption methods to increase the security of your wireless LAN connection. Using encryption reduces the risk of unauthorized access to your data.

To use WLAN, you must create an internet access point (IAP) in a WLAN. Use the access point for applications that need to connect to the internet. A WLAN connection is established when you create a data connection using a WLAN internet access point. The active WLAN connection is ended when you end the data connection. You can also end the connection manually. [See "Connection manager" on page 44.](#)

You can use WLAN during a voice call or when packet data is active. You can only be connected to one WLAN access point device at a time, but several applications can use the same internet access point.

When the device is in the Offline profile, you can still use WLAN (if available). Remember to comply with any applicable safety requirements when establishing and using a WLAN connection.

If you move the device to another location within the WLAN and out of range of a WLAN access point, the roaming functionality can automatically connect your device to another access point that belongs to the same network. As long as you remain within range of access points that belong to the same network, your device can stay connected to the network.



**Tip:** To check the unique media access control (MAC) address that identifies your device, for example to configure the MAC address of your device to a WLAN router, enter \*#62209526# on the device keypad. The MAC address is shown on the device display.

### ■ WLAN wizard

Select  > **Connectivity** > **WLAN wiz.**

The WLAN wizard helps you find and connect to a wireless LAN. When you open the application, your device starts to scan for available WLANs and lists them.

To update the list of available WLANs, select **Options** > **Refresh**.

To start or continue browsing the web using the access point of the WLAN, scroll to the desired network, and select **Options** > **Start Web browsing** or **Cont. Web browsing**.

To disconnect the active connection to the WLAN, select **Options** > **Disconnect WLAN**.

To view the details of the WLAN, select **Options** > **Details**.

To define an internet access point for the selected WLAN, select **Options** > **Define access point**.

Always enable one of the available encryption methods to increase the security of your WLAN connection. Using encryption reduces the risk of unauthorized access to your data.

#### Use the wizard in the active standby mode

In the active standby mode, the WLAN wizard shows the status of your WLAN connections and network searches. To view the available options, scroll to the row showing the status, and press the scroll key. Depending on the status, you can start the Web browser using a WLAN connection, disconnect from a WLAN, search for WLANs, or set the network scanning on or off.

If WLAN scanning is off and you are not connected to any WLAN, **WLAN scanning off** is displayed in the active standby mode. To set scanning on and search for available WLANs, scroll to the row showing the status, and press the scroll key.

To start a search for available WLANs, scroll to the row showing the status, press the scroll key, and select **Search for WLAN**. To set WLAN scanning off, scroll to the row showing the status, press the scroll key, and select **Switch WLAN scan off**.

When **Start Web browsing** is selected, the WLAN wizard automatically creates an internet access point for the selected WLAN. The access point can also be used with other applications requiring WLAN connection.

## Wireless local area network

If you select a secured WLAN, you are asked to enter the relevant passcodes. To connect to a hidden network, you must enter the correct hidden service set identifier (SSID).

### ■ WLAN access points

To search for WLANs available within range, select [☰](#) > [Connectivity](#) > [WLAN wiz.](#) To create an internet access point in a WLAN, select [Options](#) > [Define access point](#). To view the details of a network shown in the list, select [Options](#) > [Details](#).

When an application asks you to select an access point, select the created access point. You can also create an internet access point by selecting [Search for WLAN](#), or use Connection manager to create internet access points. [See "Connection manager" on page 44.](#)

### ■ Set up an internet access point for WLAN manually

1. Select [☰](#) > [Tools](#) > [Settings](#) > [Connection](#) > [Access points](#).
2. Select [Options](#) > [New access point](#) to create a new access point, or select an existing access point from the list and then [Options](#) > [Duplicate access point](#) to use the access point as a basis for the new one.
3. Define the following settings.
  - **Connection name** — Enter a descriptive name for the connection.
  - **Data bearer** — Select [Wireless LAN](#).
  - **WLAN network name** — To enter the service set identifier (SSID), that is, the name that identifies the specific WLAN, select [Enter manually](#). To select the network from the WLANs in range, select [Search for networks](#).
  - **Network status** — Select [Hidden](#) if the network you are connecting to is hidden or [Public](#) if it is not hidden.
  - **WLAN network mode** — If you select [Infrastructure](#), devices can communicate with each other and with wired LAN devices through a WLAN access point. If you select [Ad-hoc](#), devices can send and receive data directly with each other, and no WLAN access point is needed.
  - **WLAN security mode** — You must select the same security mode that is used in the WLAN access point. If you select WEP (wired equivalent privacy), 802.1x, or WPA/WPA2 (Wi-Fi protected access), you must also configure the relevant additional settings.
  - **WLAN security settings** — Edit the security settings for the selected [WLAN security mode](#).
  - **Homepage** — Enter the web address of the page you want to display as the home page when you use this access point.

### ■ Advanced internet access point settings for WLAN

After setting up a basic internet access point for WLAN, select [Options](#) > [Advanced settings](#), and define the following advanced settings:

- **IPv4 settings** — Enter the device IP and name server addresses for the IPv4 internet protocol.
- **IPv6 settings** — Select or enter the name server addresses for the IPv6 internet protocol.
- **Ad-hoc channel** — The channel is usually chosen automatically. To enter the channel number (1-11) manually, select [User defined](#).
- **Proxy server address** — Enter the proxy server address.
- **Proxy port number** — Enter the proxy server port number.

The settings available for editing may vary. Contact your service provider for more information.

### ■ WLAN settings

[See "WLAN settings" on page 68.](#)

## 13. Web

Select  > **Web**.

To browse the web (network service), you need to configure the internet access point settings. If you are using a data call or GPRS connection, your wireless network must support data calls or GPRS, and the data service must be activated for your SIM card.

Check the availability of services, pricing, and fees with your service provider. Service providers also give you instructions on how to use their services.

### ■ Access points

Your device might have configured the internet access point settings automatically based on your SIM card. If not, contact your service provider for the correct settings.



**Tip:** You may receive the internet access point settings from your service provider as a special text message or from the web page of the service provider.

You can also enter the internet access point settings manually. [See "Internet access points" on page 47.](#)

### ■ Browse the web

To browse the web, select a bookmark or enter the web address manually. Use only services that you trust and that offer adequate security and protection against harmful software.



**Tip:** When you start to enter the address, the addresses of the pages you have previously visited that match your input are displayed. To open a page, scroll to its address, and press the scroll key.

To move on a web page, use the scroll key, which is shown as a pointer on the page. When you move the pointer over a link, the pointer changes into a hand. Press the scroll key to open the link. On a web page, new links usually appear underlined in blue and previously visited links in purple. Images that act as links have a blue border around them.

The addresses of the pages you visit are saved in the **Auto. bookmarks** folder.

### ■ Bookmarks

Your device may have preinstalled bookmarks and links for third-party internet sites. You may also access other third-party sites through your device. Third-party sites are not affiliated with Nokia, and Nokia does not endorse or assume liability for them. If you choose to access such sites, you should take precautions for security or content.

To view a bookmarked web page, scroll to the bookmark, and press the scroll key.

To browse to another web page, select **Options** > **Navigation options** > **Go to web address**, enter the page address, and select **Go to**.

To organize your bookmarks, select **Options** > **Bookmark manager** in the Web main view. You can move and edit bookmarks, and create new folders.

To add a bookmark, select **Options** > **Bookmark manager** > **Add bookmark**, and define the following:

- **Name** — Give a descriptive name for the bookmark.
- **Address** — Enter the web page address.
- **Access point** — Define the access point to connect to the web page.
- **User name** — Enter your user name, if required by the service provider.
- **Password** — Enter your password, if required by the service provider.

### ■ End a connection

To end the connection and view the browser page offline, select **Options** > **Tools** > **Disconnect**. To end the connection and close the browser, select **Options** > **Exit**.

### ■ Clear the cache

A cache is a memory location that is used to store data temporarily. If you have tried to access or have accessed confidential information requiring passwords, empty the cache after each use. The information or services you have accessed are stored in the cache.

To empty the cache, select **Options** > **Clear privacy data** > **Clear cache**.

## ■ News feeds and blogs

Select  > [Web](#) > [Web feeds](#).

Feeds usually contain headlines and articles, often about recent news or other topics. Blog is a shortening of weblog, which is a continuously updated web diary.

To download a feed or blog, scroll to it, and press the scroll key.

To add a feed or blog, select [Options](#) > [Manage feed](#) > [New feed](#).

To edit a feed or blog, select [Options](#) > [Manage feed](#) > [Edit](#).

## ■ General settings

Select [Options](#) > [Settings](#) > [General](#) and from the following:

- [Access point](#) — Select the access point to connect to web pages.
- [Homepage](#) — Select the page that you want to appear as your home page. Select [Default](#) to use the access point home page, [User defined](#) to enter the home page address, or [Use current page](#) to use the currently open web page.
- [Mini map](#) — Select whether you want to see an overview of the page as a miniature on top of the page you are viewing.
- [History list](#) — Select whether you want to see miniatures of the pages you have visited when you want to go back in your browsing history.
- [Java/ECMA script](#) — Some web pages may include program commands that affect the appearance of the page or interaction between the page and its browsers. To deny the use of such scripts, select [Disabled](#) (for example, if you have trouble downloading).
- [Security warnings](#) — Select [Show](#) or [Hide](#) to see or hide the security warnings you may receive during browsing.

## ■ Page settings

Select [Options](#) > [Settings](#) > [Page](#) and from the following:

- [Load images and sounds](#) — Select [No](#) to load pages faster when browsing by not loading the images on them.
- [Screen size](#) — Select [Full screen](#) to use the whole display area for viewing web pages. You can press the left selection key to open [Options](#) and use the available options while browsing in the full screen mode.
- [Font size](#) — Select the preferred font size for the displayed web pages.
- [Volume](#) — Set the volume level for the sounds on web pages.
- [Block pop-ups](#) — Select whether you want to allow pop-ups. Some pop-ups may be necessary (for example, smaller windows where you write e-mail messages in web-based mail systems), but they may also contain unwanted advertising.
- [Default encoding](#) — Select the correct character encoding for your language.
- [Automatic reload](#) — Select whether you want web pages to reload automatically.

## ■ Privacy settings

Select [Options](#) > [Settings](#) > [Privacy](#) and from the following:

- [Auto. bookmarks](#) — Select [On](#) to save the web page addresses that you visit automatically in the [Auto. bookmarks](#) folder. To hide the folder, select [Hide folder](#).
- [Form data saving](#) — Select whether to save form data on web pages. If you set this setting off, the previously saved data is deleted.
- [Cookies](#) — Select to allow or reject the sending and receiving of cookies. Cookies are information the network server collects about your visits to various web pages. They are necessary if you shop on the web (for example, to retain the items you buy until you reach the cashier page). However, the information may be misused (for example, you may receive unwanted advertisements in your device).
- [Serial no. sending](#) — Select whether to send the serial number (IMEI code) of your device to web sites.

## ■ Web feed settings

To select whether to update feeds and blogs automatically, select [Options](#) > [Settings](#) > [Web feeds](#) > [Automatic updates](#).

## 14. Global Positioning System (GPS)

Select  > [GPS](#).

The Global Positioning System (GPS) is a worldwide radio navigation system that includes 24 satellites and their ground stations that monitor the operation of the satellites.

A GPS terminal, such as the GPS receiver in the Nokia E90 Communicator, receives low-power radio signals from the satellites, and measures the travel time of the signals. From the travel time, the GPS receiver can calculate its location to the accuracy of meters.

Coordinates are expressed in degrees and decimal degrees format using the WGS-84 coordinate system.

The Global Positioning System (GPS) is operated by the government of the United States, which is solely responsible for its accuracy and maintenance. The accuracy of location data can be affected by adjustments to GPS satellites made by the United States government and is subject to change with the United States Department of Defense civil GPS policy and the Federal Radionavigation Plan. Accuracy can also be affected by poor satellite geometry. Availability and quality of GPS signals may be affected by your location, buildings, natural obstacles, and weather conditions. The GPS receiver should only be used outdoors to allow reception of GPS signals.

GPS should only be used as a navigation aid. It should not be used for precise location measurement and you should never rely solely on location data from the GPS receiver for positioning or navigation.

The trip meter has limited accuracy, and rounding errors may occur. Accuracy can also be affected by availability and quality of GPS signals.

### ■ **Nokia Maps**

Select  > [GPS](#) > [Maps](#).

With Maps, you can see your current location on the map, browse maps for different cities and countries, search for addresses and different points of interest, plan routes from one location to another, and save locations as landmarks and send them to compatible devices. You can also purchase extra services, such as guides and a turn-by-turn navigation service with voice guidance.

When you use Maps for the first time, you may need to define an internet access point for downloading map information for your current location. To change the default access point later, select [Options](#) > [Settings](#) > [Network](#) > [Default access point](#).

Almost all digital cartography is inaccurate and incomplete to some extent. Never rely solely on the cartography provided for use in this device.

### **Download maps**

When you browse the map on the display, for example, move to another country, a new map is downloaded automatically. These downloaded maps are free of charge, but downloading may involve the transmission of large amounts of data through your service provider's network. For more information on data transmission charges, contact your service provider.

You can view the amount of transferred data from the data counter (kB) shown on the display. The counter shows the amount of network traffic when you browse maps, create routes, or search for locations online.

To prevent the device from automatically downloading maps through the internet, for example, when you are outside your home cellular network, select [Options](#) > [Settings](#) > [Network](#) > [Use network](#) > [Off](#).

To receive a note when your device registers to a network outside your home cellular network, select [Options](#) > [Settings](#) > [Network](#) > [Roaming warning](#) > [On](#).

To adjust the size of the cache that is used for saving maps or voice guidance files, select [Options](#) > [Settings](#) > [Network](#) > [Max. memory card use \(%\)](#). This option is available only when a compatible memory card is inserted. When the memory is full, the oldest map data is deleted. The cache cannot be emptied.

### **Nokia Map Loader**

Nokia Map Loader is PC software that you can use to download and install maps for different countries from the internet to your device or a compatible memory card (if inserted). You can also use it to download voice files for turn-by-turn navigation.

To use Nokia Map Loader, you must first install it to a compatible PC. You can download the PC software from the internet at [www.nokia.com/maps](http://www.nokia.com/maps).

You must use Nokia Maps before using Nokia Map Loader. Nokia Map Loader uses the Maps history information to check the version of map data to be downloaded.

After you have installed the PC software to your PC, to download maps, do the following:

1. Connect your device to the PC by using a compatible USB data cable.
2. Open Nokia Map Loader on your PC. Nokia Map Loader checks the version of map data to be downloaded.

## Global Positioning System (GPS)

3. Select the maps or voice guidance files you want, and download and install them to your device.

### Satellite information

The GPS indicator  is shown on the display when you browse maps. When the device tries to establish a GPS connection, the circles are yellow and the icon is blinking. When the device receives enough data from the satellites to calculate the coordinates of your current location, the icon stops blinking and turns green.

To check how many satellites your device has found, and whether your device is receiving satellite signals from the satellites, select **Options** > **Map options** > **Satellite info**.

If your device has found satellites, a bar for each satellite is shown in the satellite info view. The longer the bar, the stronger the satellite signal. When your device has received enough data from the satellite signal to calculate the coordinates of your location, the bar turns black.

Initially your device must receive signals from at least four satellites to be able to calculate the coordinates of your location. When the initial calculation has been made, it may be possible to continue calculating the coordinates of your location with three satellites. However, the accuracy is generally better when more satellites are found.

### Browse maps

The map coverage varies by country.

When you open the Maps application, Maps zooms in to the location that was saved from your last session. If no position was saved from the last session, Maps zooms in to the capital city of the country you are in based on the information the device receives from the cellular network. At the same time, the map of the location is downloaded, if it has not been downloaded during previous sessions.

To establish a GPS connection and zoom in to your current location, select **Options** > **Find place** > **GPS position [0]**, or press **0**. Your current location is indicated on the map with .

To move on the map, scroll up, down, left, or right.

To switch between the 2D and 3D views, select **Options** > **Map options** > **2D/3D**.

To find a location, select **Options** > **Find place**.

To use a location on the map, for example, as a starting point for a nearby search, to plan a route, view its details, or start navigation (extra service), press the scroll key, and select the desired option.

To zoom in or out, press **\*** or **#**.

To define what kinds of points of interest are shown on the map, select **Options** > **Map options** > **Categories**.

To capture a screen shot of your location, select **Save** > **As image**. The screen shot is saved in Gallery.

To save a location as a landmark, press the scroll key and select **Save** > **As landmark**.

To view saved landmarks, select **Options** > **Find place** > **Landmarks**.

To send a landmark to a compatible device, press the scroll key, and select **Send**. If you send the landmark in a text message, the information is converted to plain text.

To adjust the network, routing, and general settings, select **Options** > **Settings**.

### Search for locations

To view points of interest near your current location or other locations on the map, select **Options** > **Find place** > **Nearby** and a category.

To search for a point of interest by name, select **Options** > **Find place** > **Keyword search** or start entering the first letters of the name, and select **Find**.

To search for a location by address, select **Options** > **Find place** > **By address**. You must enter the city and country. To use an address you have saved to a contact card in Contacts, select **Options** > **Find place** > **By address** > **Options** > **Select from contacts**.

To view a search result on the map, press the scroll key, and select **Show on map**.

To view a list of your previous locations, select **Options** > **Find place** > **Recent**.

### Plan a route

1. To plan a route from one location to another, scroll to a point on the map, press the scroll key, and select **Route from**.
2. Scroll to **Select**, and select **Options** > **Select** and the desired option. To adjust the routing settings, such as the mode of transportation, select **Options** > **Settings** > **Routing**.
3. To select the destination, scroll to **To**, and select **Options** > **Select**, and the desired option.

## Global Positioning System (GPS)

4. To view the route itinerary, select **Options** > **Show route**. The route is calculated using the selected routing settings.

To view the itinerary route on the map, select **Options** > **Show on map**.

To run a simulation of the route, select **Options** > **Start simulation**.



**Tip:** You can also use a compatible GPS receiver with Bluetooth connectivity with Maps. For example, in a car, an external GPS receiver can be positioned so that it has a clear view of the sky. Enable the use of an external GPS receiver in the positioning settings.

### Extra services for Maps

You can purchase a turn-by-turn navigation service with voice guidance to use in Maps. You can also purchase and download different kinds of guides, such as city and travel guides, for different cities. The downloaded guides are automatically saved to your device.

The licence you purchase for a guide or navigation is device-specific and cannot be transferred from your device to another device.

### Navigation

To purchase a navigation service with voice guidance, select **Options** > **Extra services** > **Add navigation**.

After creating a route in Maps, to start navigation to the desired destination with GPS using voice guidance, select **Options** > **Start navigation**. You can also start navigation by selecting any location on the map or in a results list, and **Navigate to**.

When you use navigation for the first time, you are prompted to select the language of the voice guidance and download the voice guidance files of the selected language. You can also download voice guidance files using Nokia Map Loader. To change the language later, in the Maps main view, select **Options** > **Settings** > **General** > **Voice guidance**.

To discard the created route and use another route, select **Options** > **Alternative route**.

To view only the next turns and hide the map, select **Options** > **Map options** > **Next turns**.

To stop navigation, select **Options** > **Stop navigation**.

### Guides

To purchase and download guides, select **Options** > **Extra services** > **Guides**. The guides provide information about attractions, restaurants, hotels, and other points of interest. The guides must be downloaded and purchased before use.

To download a new guide to your device, scroll to the nearest guides or all guides tab, select the desired guide, and **OK**. The purchase process starts automatically. You can pay for the guides through a credit card or have the amount charged to your phone bill, if supported by your cellular network service provider.

To confirm the purchase, select **OK** twice. To receive a confirmation of the purchase through e-mail, enter your name and e-mail address, and select **OK**.

To browse a downloaded guide, scroll to the my guides tab, select a guide and a subcategory, if available.

### ■ GPS data

This feature is not designed to support positioning requests for related calls. Contact your service provider for more information about how your phone complies with government regulations on location based emergency calling services.

GPS should only be used as a navigation aid. It should not be used for precise location measurement and you should never rely solely on location data from the GPS receiver for positioning or navigation.

Select  > **GPS** > **GPS data**.

With GPS data, you can view your current location, find your way to a desired location, and track distance.

Select **Navigation** to view navigating information to your trip destination, **Position** to view positioning information about your current location, or **Trip dist.** to view your traveling information such as the distance and duration you have traveled, and your average and maximum speeds.

The application must receive positioning information from at least three satellites to be used as a traveling aid.

To select a positioning method to detect the location of your device, select **Options** > **Positioning settings**, scroll to the desired positioning method, and select **Options** > **Enable**.

To check the signal strength of the satellites that provide the positioning information necessary for navigation, open any of the three views and select **Options** > **Satellite status**.

To set a landmark or location as the destination of your trip, select **Navigation** > **Options** > **Set destination**. You can also enter the destination latitude and longitude coordinates.

To remove the destination set for your trip, select **Navigation** > **Options** > **Stop navigation**.

To save your current position as a landmark, select **Navigation** or **Position**, and **Options** > **Save position**.

## Global Positioning System (GPS)

To activate the trip meter, select **Trip dist.** > **Options** > **Start**. To stop the trip meter, select **Options** > **Stop**.

To reset all fields and start calculating the trip again, select **Trip dist.** > **Options** > **Restart**.

To change the measuring system in use, select **Options** > **Settings** > **Measurement system** > **Metric** or **Imperial**.

To enter the altitude calibration to correct the altitude received from the positioning satellites, select **Options** > **Settings** > **Altitude calibration**.

### ■ Landmarks

Select  > **GPS** > **Landmarks**.

Landmarks are coordinates to geographic locations that you can save to your device for later use in different location-based services. You can create landmarks using the internal GPS receiver of your device or network (network service).

To create a landmark, select **Options** > **New landmark**. Select **Current position** to make a network request for the latitude and longitude coordinates of your current location, **Use map** to select the location from a map, or **Enter manually** to fill in necessary location information such as a name, category, address, latitude, longitude, and altitude.

To show the landmark on the map, select **Options** > **Show on map**.

### Edit landmarks

To edit a landmark, select **Options** > **Edit** > **Options** and from the following:

- **Select categories** — Organize the landmark to a group of similar landmarks. Select a category to modify landmark information such as a name, category, address, latitude, longitude, and altitude.
- **Retrieve current position** — Request and automatically fill in the geographical latitude and longitude coordinates to make a landmark of your current location.
- **Delete** — Remove the landmark.
- **Landmark icon** — Change the icon of the landmark.
- **Show on map** — Show the landmark on the map.
- **Send** — Send the landmark to compatible devices.
- **Editing options** — Edit the phone numbers and URL addresses assigned to the landmark.
- **Writing language** — Change the writing language.

### Landmark categories

You can see the landmark categories in two views: one lists categories that already contain landmarks, and the other lists all the categories your device has.

To view the landmarks that a category contains, scroll to the category, and press the scroll key.

To create a new category, select **Options** > **Edit categories** > **Options** > **New category**.

To move a landmark from one category to another, open the landmarks tab, select the landmark, and **Options** > **Add to category**. Select the old category to remove the mark next to it. Select the category or categories to which you want to add the landmark. Select **Accept**.

### Receive landmarks

Select  > **Messaging**.

Open a message that contains a landmark you have received from another device. Scroll to the landmark, and press the scroll key.

To save the landmark in your device, select **Options** > **Save**.

To forward the landmark to compatible devices, select **Options** > **Send**.

To show the received landmark on the map, select **Options** > **Show on map**.

To find out how to navigate to the received landmark, select **Options** > **Show route**.



## 15. Business voice applications

---

### ■ Push to talk

Select  > [Connectivity](#) > [PTT](#).

Push to talk (PTT) (network service) provides direct voice communication connected with the push of a key. With push to talk, you can use your device as you would use a walkie-talkie.

You can use push to talk to have a conversation with one person or with a group of people, or to join a channel. A channel is like a chat room: you can call the channel to see if anyone is online. The channel call does not alert the other users; the users just join the channel and start speaking with each other.

In push-to-talk communication, one person talks while the other users listen through the built-in loudspeaker. Users take turns responding to each other. Because only one user can talk at a time, the maximum duration of a speech turn is limited. For details of the speech turn duration for your network, contact your service provider.

Before you can use push to talk, you must define the push-to-talk access point and push-to-talk settings. You may receive the settings in a message from the service provider that offers the push-to-talk service.

Phone calls always take priority over push to talk.

#### Push-to-talk settings

Select [Options](#) > [Settings](#) and select [User settings](#) to define your preferences for push to talk, or [Connection settings](#) to change the connection details. Contact your service provider for the correct settings.

The settings available for editing may vary.

#### Log in to push-to-talk service

If you have set [Application start-up](#) on in [User settings](#), push to talk automatically logs in to the service when started. If not, you must log in manually.

To log in to push-to-talk service manually, select [Options](#) > [Log in to PTT](#).

When the [Ringing type](#) setting of your device is set to [Beep once](#) or [Silent](#), or there is an ongoing phone call, you cannot make or receive push-to-talk calls.

#### Make a push-to-talk call



**Warning:** Do not hold the device near your ear when the loudspeaker is in use, because the volume may be extremely loud.

To make a push-to-talk call, select [Options](#) > [Contacts](#), select one or several contacts from the list, and press the voice key. Remember to hold the device in front of you during a push-to-talk call so you can see the display. The display informs you when it is your turn to speak. Speak towards the microphone, and do not cover the loudspeaker with your hands. Press and hold the voice key the entire time you are talking. When you have finished talking, release the key.

To end the push-to-talk call, press the end key.

When you receive a push-to-talk call, press the call key to answer the call or the end key to dismiss the call.

#### Manage PTT contacts

To view, add, modify, delete, or call contacts, select [Options](#) > [Contacts](#). A list of names from the Contacts application is displayed with information about their login status.

To call a selected contact, select [Options](#) > [Talk 1 to 1](#).

To make a group call, select several contacts and [Options](#) > [Talk to many](#).

To send the contact a request to call you, select [Options](#) > [Send callback request](#).

To answer a callback request, select [Show](#) to open the callback request. To make a push-to-talk call to the sender, press the voice key.

#### Create a PTT channel

To create a channel, select [Options](#) > [New channel](#) > [Create new](#).

To register the channel to the push-to-talk service, select [Options](#) > [Register](#).

To join a channel, select the channel you want to talk to, and press the voice key.

To invite a user to a channel, select [Options](#) > [Send invitation](#).

## Business voice applications

To view the currently active users of a channel, select **Options** > **Active members**.

To view more information about a selected user, select **Options** > **Contact details**.

When you log in to push to talk, push to talk automatically connects to the channels that were active when the application was last closed.

### Exit push to talk

To exit push to talk, select **Options** > **Exit**. Select **Yes** to log out and close the service. Select **No** if you want to keep the application active in the background.

### ■ Recorder

Select  > **Media** > **Recorder**.

With Recorder, you can record up to 60 seconds of a voice memo, save the voice recording as a sound clip, and play the sound clip. Recorder supports the AMR file format.

Press the voice key to activate Recorder. If you have logged in to push to talk, the voice key works as a push-to-talk key and does not activate Recorder.

To record a voice memo, select **Options** > **Record sound clip**. Select **Pause** to pause the recording, and **Record** to resume recording. When you finish recording, select **Stop**. The sound clip is automatically saved to the Sound clips folder in Gallery.

The maximum length of a voice recording is 60 seconds, but it also depends on the storage space available in the device memory or on a memory card.

### Play a voice recording

To listen to a voice recording that you just recorded, select **Play**. The progress bar displays the playing time, position, and length of the voice recording. Select **Stop** to cancel the playback.

To pause the playback of a voice recording, select **Pause**. Playback resumes when you select **Play**.

### Voice recorder settings

Voice recordings are automatically saved to the device memory unless you change the default location. Voice recordings that you create or receive after you change the settings are affected.

To change the default location of saved voice recordings, select **Options** > **Settings** > **Memory in use**.

To define the recording quality, select **Options** > **Recording quality**.



**Tip:** Waveform files (.wav) are a more common audio file format, but adaptive multirate files (.amr) are smaller for comparable sound quality.

### ■ Voice aid

Select  > **Tools** > **Voice aid**.

The Voice aid application reads text on the screen, allowing you to use the basic functions of your device without looking at the display.

To hear the entries in your contacts list, select **Contacts**. Do not use this option if you have more than 500 contacts.

To hear information on your missed and received calls, dialed numbers, and frequent calls, select **Recent calls**.

To listen to your voice messages, select **Voice mailbox**.

To dial a telephone number, select **Dialler**.

To hear the current time, select **Clock** > **Time**. To hear the current date, select **Clock** > **Date**.

To hear more options, select **Options**.

### ■ Speech

Select  > **Tools** > **Speech**.

With Speech, you can set the language, voice, and voice properties for the message reader.

To set the language for the message reader, select **Language**.

To set the speaking voice, select **Voice**. The voice is language-dependent.

To set the speaking rate, select **Voice settings** > **Speed**.

To set the speaking volume, select **Voice settings** > **Volume**.

## Business voice applications

To listen to a voice, open the voice tab, select the voice, and select [Play voice](#).

### ■ Voice commands

Select [Voice](#) > [Tools](#) > [Voice comm..](#)

Use voice commands to make phone calls and launch applications, profiles, or other functions on the device.

The device creates a voice tag for the entries in Contacts and for the functions designated in the Voice commands application. When a voice command is spoken, the device compares the spoken words to the voice tag in the device. Voice commands are not dependent on a speaker's voice; however, the voice recognition in the device adapts to the main user's voice to recognize voice commands better.

#### Make a call

A voice tag for a contact is the name or nickname that is saved on the contact in Contacts.

To listen to a voice tag, open a contact, and select [Options](#) > [Play voice tag](#).

1. To make a call using a voice command, press and hold the voice key.
2. When you hear the tone or see the visual display, clearly speak the name saved on the contact.
3. The device plays a synthesized voice tag for the recognized contact in the selected device language, and displays the name and number. After a timeout of 1.5 seconds, the device dials the number. If the recognized contact was not correct, select [Next](#) to view a list of other matches or [Quit](#) to cancel dialing.

If several numbers are saved under the contact, the device selects the default number, if it has been set. Otherwise, the device selects the first available number of the following fields: [Mobile](#), [Mobile \(home\)](#), [Mobile \(business\)](#), [Telephone](#), [Tel. \(home\)](#), and [Tel. \(business\)](#).

#### Launch an application

The device creates voice tags for the applications listed in the Voice commands application.

To launch an application using a voice command, press and hold the voice key, and clearly speak the name of the application. If the recognized application was not correct, select [Next](#) to view a list of other matches or [Quit](#) to cancel.

To add more applications to the list, select [Options](#) > [New application](#).

To change the voice command of an application, select [Options](#) > [Change command](#), and enter the new command.

#### Change profiles

The device creates a voice tag for each profile. To set on a profile using a voice command, press and hold the voice key, and say the name of the profile.

To change the voice command, select [Profiles](#) > [Options](#) > [Change command](#).

#### Voice command settings

To switch off the synthesizer that plays recognized voice commands in the selected device language, select [Settings](#) > [Synthesiser](#) > [Off](#).

To reset voice recognition learning when the main user of the device has changed, select [Remove voice adapts..](#)

## 16. Media applications

---

Select  > **Media**.

Media contains different media applications that allow you to save and view images, record sounds, and play sound clips.

### ■ RealPlayer

Select  > **Media** > **RealPlayer**.

RealPlayer plays video clips and audio files that are stored in the device memory or on a memory card, transferred to your device from an e-mail message or a compatible computer, or streamed to your device over the web. Supported formats include MPEG-4, MP4 (not streaming), 3GP, RV, RA, AAC, AMR, and Midi. RealPlayer does not necessarily support all variations of a media file format.

#### Play video clips and stream links



**Warning:** Do not hold the device near your ear when the loudspeaker is in use, because the volume may be extremely loud.

To play a video clip or audio file, select **Options** > **Open** > **Most recent clips** to play one of the six video clips you most recently played, or **Saved clip** to play a video clip, or to open a web link. Select **Play**.

To play streaming media, select a web link that points to a media clip, and select **Play**; or connect to the web, browse to a video clip or audio file, and select **Play**. RealPlayer recognizes two kinds of links: an `rtsp://` URL and an `http://` URL that points to a RAM file. Before the content begins streaming, your device must connect to a web site and buffer the content. If a network connection problem causes a playback error, RealPlayer attempts automatically to reconnect to the internet access point.

To adjust the volume during playback, scroll right or left.

To fast-forward during playback, scroll up and hold. To rewind during play, scroll down and hold.

To stop the playback or streaming, select **Stop**. Buffering or connecting to a streaming site stops, the playback of a clip stops, and the clip rewinds to the beginning.

To download video clips from the web, select **Options** > **Download videos**.

To view the video clip in full-screen size, select **Options** > **Play in full screen**. Full screen increases the size of the video to cover the maximum video area possible while the aspect ratio is maintained.



**Tip:** To switch between the normal screen and full screen quickly, press **2** on the keypad.

#### Send audio files and video clips

To transfer a media clip to a compatible device, select **Options** > **Send**. Select the sending method.

To send a media clip inside a message, create a multimedia message, select a clip to attach and **Insert object** > **Video clip** or **Sound clip**.

To remove the media clip you inserted, select **Options** > **Remove** > **Yes**.

#### View information about a media clip

To view the properties of a video clip, audio file, or web link, select **Options** > **Clip details**. Information may include for example the bit rate or the internet link of a streaming file.

To set on file protection for a media clip, select **Options** > **Clip details** > **Status** > **Options** > **Change**. File protection prevents others from changing a file.

#### RealPlayer settings

You may receive RealPlayer settings in a message from your service provider.

To define the settings manually, select **Options** > **Settings** > **Video** or **Streaming**.

### ■ Music player



**Warning:** Do not hold the device near your ear when the loudspeaker is in use, because the volume may be extremely loud.

Select  > **Media** > **Music player**.

With Music player, you can play music files, and create and listen to track lists. Music player supports files with extensions such as MP3 and AAC.

## Listen to music



**Warning:** Listen to music at a moderate level. Continuous exposure to high volume may damage your hearing.

To select a music track, select **Options** > **Music library**. **All tracks** lists all music on your device. To view sorted songs, select **Albums**, **Artists**, **Genres**, or **Composers**.

To play the track, select **Options** > **Play**. To pause the playing, scroll to  and press the scroll key.

To select the previous or next track, scroll up or down.

To control the music volume, scroll right or left. To mute the volume, scroll left until the volume is muted.

To stop a track, scroll to  and press the scroll key.

To play the music tracks repeatedly, select **Options** > **Loop**. Select **All** to repeat all the tracks in the current folder, **One** to repeat the selected track, or **Off** to set off the repeating.

To play music in random order, select a folder and **Options** > **Random play**.

After you have added or removed music files in the device, update your music library. Select **Options** > **Update Music library**. Music player searches the device memory for music files and updates them to the music library.

To view music track information, select **Options** > **View details**.

## Track lists

You can create a new track list and add tracks to it, or edit a saved track list.

To create a new track list, select **Options** > **Music library** > **Track lists** > **Options** > **New track list**.

To add a track to a track list, open the track list, and select **Options** > **Add tracks**.

## Equalizer

Select  > **Media** > **Music player** > **Options** > **Equaliser**.

With Equalizer, you can personalize the sound of your music files. You can use preset frequency settings based on styles of music. You can also create customized settings based on your own listening preferences.

You cannot use the other functions of Music player while Equalizer is open.

To use a preset frequency setting when playing music, select the frequency setting you want to use, and select **Options** > **Activate**.

To modify the frequency of a preset setting, select **Options** > **Edit**, select a frequency band, and scroll up or down to increase or decrease its value. You hear your frequency adjustment immediately in the playback.

To reset the frequency bands to their original values, select **Options** > **Reset to defaults**.

To create your own frequency setting, select **Options** > **New preset**. Enter a name for the frequency setting. Scroll up or down to move between the frequency bands and set the frequency on each band.

## Flash player

Select  > **Media** > **Flash Player**.

With Flash player, you can view, play, and interact with flash files made for mobile devices.

To play a flash file, scroll to it, and press the scroll key.

To send a flash file to compatible devices, select **Options** > **Send**. Copyright protection may prevent the sending of some flash files.

To switch between flash files saved on your device memory or memory card, open the corresponding tabs.

To change the flash file quality, select **Options** > **Quality** when you are playing the flash file. If you select **High**, the playback of some flash files may appear uneven and slow due to their original settings. Change the quality setting of such files to **Normal** or **Low** for improved playback.

## Camera

Select  > **Media** > **Camera**.

You can capture images or record video clips with the built-in camera. The camera produces images in .jpeg format and video clips in .mp4 or .3gpp format.

## Capture an image

Your device supports an image capture resolution of up to 2048 x 1536 pixels.

To capture an image, use the display as a viewfinder, aim at your subject, and press the capture key half way down. The camera focuses on the subject. Then press the capture key all the way down. The device saves the image in Gallery.



**Tip:** To zoom in or out before capturing an image, scroll left or right.









## Camera toolbar

The toolbar provides you with shortcuts to different actions and settings before and after capturing an image or recording a video. Scroll to the desired action, and press the scroll key.

To show the toolbar before and after capturing an image or recording a video, select **Options** > **Show icons**.

To hide the toolbar, select **Options** > **Hide icons**. To show the toolbar again, press the scroll key.

The available actions are:

-  Switch between the video and image modes.
-  Select the scene. A scene helps you to find the right color and lighting settings for the current environment.
-  Use the flash (images only).
-  Activate the self-timer (images only).
-  Activate the sequence mode (images only).
-  Select a color effect.
-  Adjust the white balance.
-  Adjust the exposure compensation (images only).
-  Adjust the light sensitivity (images only).

The available options vary depending on the capture mode and view you are in.

## After capturing an image

To delete the captured image, select **Delete** from the toolbar. Select **Back** to return to the viewfinder to capture another image.

To print the image, select **Print** from the toolbar.

To set the image as the background image in the active standby, select **Options** > **Set as wallpaper**.

To assign the image for a contact, select **Set as contact call image**.

To view and modify images, select  > **Media** > **Gallery** > **Images**.

## Still image settings

To adjust the still image settings, select **Options** > **Settings** and from the following:

- **Image quality** — Select the desired image quality.
- **Add to album** — Select a folder where to save the image in Gallery.
- **Show captured image** — Select whether to see the image after it is captured, or to continue capturing images immediately.
- **Default image name** — Define the default name for the captured images.
- **Extended digital zoom** — Select whether to allow the zoom increments to be smooth and continuous between the digital and the extended digital zoom. If you want to limit the zoom to where the selected image quality is maintained, select **Off**.
- **Capture tone** — Select the tone you want to hear when you capture an image.
- **Memory in use** — Select where to store your images.
- **Restore camera settings** — Select whether to reset the camera settings to the default values.

## Record a video clip

Select **Video mode** from the toolbar. To start recording a video clip, press the capture key. To pause the recording, select **Pause**; to resume the recording, select **Continue**. To stop the recording, select **Stop**. The device saves the clip in Gallery.

## After recording a video clip

To play the video clip you just recorded, select **Play** from the toolbar.

To delete the video clip, select **Delete** from the toolbar.

To record a new video clip, select **New video** from the toolbar.

## Video settings

Select **Options** > **Settings** and from the following:

- **Video quality** — Select the video quality.
- **Video stabilisation** — Select whether to reduce camera shaking when recording the video.
- **Audio recording** — Select whether to include audio in the recording.
- **Add to album** — Select a folder where to save the video clip in Gallery.
- **Show captured video** — Select whether you want the first frame of the recorded video clip to be shown on the display after the recording stops.
- **Default video name** — Define the default name for the captured video clips.
- **Memory in use** — Define the default memory store for video clips.
- **Restore camera settings** — Select whether to reset the camera settings to the default values.

## ■ Gallery

Select  > **Media** > **Gallery**.

Use Gallery to access and use different types of media, including images, videos, music, and sounds. All viewed images and videos and all received music and sounds are automatically saved to Gallery. You can browse, open, and create folders and mark, copy, and move items to folders. Sound clips are opened in the Music player, and video clips and streaming links in the RealPlayer application. Images are opened in the image viewer.

To open a file or a folder, scroll to it, and press the scroll key.

To create a new folder, select **Options** > **Organise** > **New folder**.

To copy or move files, select a file and **Options** > **Organise** > **Move to folder**, **New folder**, **Move to memory card**, **Copy to memory card**, **Copy to phone mem.**, or **Move to phone mem.**

To download files into Gallery using the browser, select **Downl. graphics**, **Downld. videos**, **Downld. tracks**, or **Downld. sounds**. The browser opens, and you can choose a bookmark or enter the address for the download site.

To search for a file, select **Options** > **Find**. Write the item you are searching for. Files that match the search are shown.

## Images

Select  > **Media** > **Gallery** > **Images**.

Images consists of two views:

- In the image browser view you can organize, delete, and rename images stored in your device or memory card. You can also set images as wallpaper for your display, or add them to contacts.
- In the image viewer, which opens when you select an image in the image browser view, you can view and send individual images.

The following file formats are supported: JPEG, BMP, PNG, and GIF 87a/89a. The device does not necessarily support all variations of the file formats.

To open an image for viewing, select **Options** > **Open**.

To open the next or previous image for viewing, scroll right or left.

To enlarge the image on the display, select **Options** > **Zoom in**. To reduce the image on the display, select **Zoom out**.

To view the image in full screen size, select **Options** > **Full screen**. To return to normal view, select **Options** > **Normal screen**.

To rotate the image, select **Options** > **Rotate**. Select **Right** to rotate the image clockwise by 90 degrees, or select **Left** to rotate the image counterclockwise by 90 degrees.

### Manage image files

To view detailed information about the image, select **Options** > **View details**.

To send the image, select **Options** > **Send**, and the method for sending.

To rename the image, select **Options** > **Rename**.

To set the image as wallpaper, select **Options** > **Use image** > **Set as wallpaper**.

To add the image to a contact, select **Options** > **Add to contact**. The Contacts application opens, and you can select the contact for the image.

### Organize images

To create folders to organize your images, select **Options** > **Organise** > **New folder**.

## Media applications

To move the image to another folder, select **Options** > **Organise** > **Move to folder**. Scroll to the folder to which you want to move the image, and select **Move**.

### ■ Radio



Select  > **Media** > **Radio**.

With the radio, you can search for radio channels, listen to them, and save them on your device. You can leave the radio open in the background while using the device for other purposes. The wired headset works as an antenna, so always connect the headset when using the radio, even if you listen to it through the loudspeaker. When you make or receive a phone call, the radio stops playing, and resumes when you end the call. You cannot listen to the radio when the device is in the Offline profile.

To tune channels automatically, select the  or  button.

To tune channels manually, select **Options** > **Manual tuning**, and enter the frequency.

To save the found channel, select **Options** > **Save station**. Select the position for the channel in the list. The position corresponds to the number keys on the keypad. A short press of a number key opens the radio channel saved in that position. If you have a channel saved to position 10 or higher, first press 1 and then the second digit.

To listen to the next available channel, select the  button. To listen to the previous channel, select the  button. You can also go from channel to channel by pressing the answer button in your headset.

To adjust the volume, scroll left or right.

To switch from headset use to loudspeaker, select **Options** > **Activate loudspeaker**. To switch back to headset use, select **Options** > **Deactivate loudspeaker**.

To set the radio to play in the background while you are using your device for other purposes, select **Options** > **Play in background**.

To switch the radio off, select **Exit**.

### ■ 3-D ringing tones

Select  > **Media** > **3-D ringing tones**.

To enable three-dimensional sound effects for ringing tones, select **3-D ringing tone effects** > **On**. Not all ringing tones support 3-D effects.

To change the 3-D effect that is applied to the ringing tone, select **Sound trajectory** and the desired effect.

To modify the 3-D effect, select from the following:

- **Trajectory speed** — Select the speed at which sound moves from one direction to another. This setting is not available for all effects.
- **Reverberation** — To adjust the amount of echo, select the desired effect in the list.
- **Doppler effect** — Select **On** to have the ringing tone sound higher when you are closer to your device, and lower when you are farther away. This setting is not available for all effects.

To listen to the ringing tone with the 3-D effect applied, select **Options** > **Play tone**.

To adjust the volume of the ringing tone, select  > **Tools** > **Profiles** > **Options** > **Personalise** > **Ringling volume**.



## 17. Settings

Select  > **Tools** > **Settings**.

You can define and modify various settings of your device. Modifying these settings affects the operation of your device across several applications.

Some settings may be preset for the device or sent to you in a special message by your service provider. You may not be able to change such settings.

Select the setting you want to edit to do the following:

- Switch between two values, such as on or off.
- Select a value from a list.
- Open a text editor to enter a value.
- Open a slider to decrease or increase the value by scrolling left or right.

### ■ General settings

Select  > **Tools** > **Settings** > **General**.

Select from the following:

- **Personalisation** — Change the display settings and personalize the device.
- **Date and time** — Change the date and time.
- **Enhancement** — Define the settings for your enhancements.
- **Security** — Define the security settings.
- **Factory settings** — Restore the original settings of the device.

### Personalization settings

Select  > **Tools** > **Settings** > **General** > **Personalisation**.

#### Display settings

To define the level of light that the device needs before switching on the backlight, select **Display** > **Light sensor**.

To change the text size, select **Display** > **Font size**.

To adjust the length of time the display can be left idle before the screen saver is activated, select **Display** > **Power saver time-out**.

To select a welcome note or logo for the display, select **Display** > **Welcome note / logo**. You can either choose the default welcome note, enter your own text, or select an image.

To set how quickly the display dims after the last keypress, select **Display** > **Light time-out**.

To set the active application to continue on the cover display when you close the communicator, select **Display** > **Cover display to Desk** > **Off**.

#### Standby mode settings

To select whether to use the active standby, select **Standby mode** > **Active standby**.

To assign shortcuts for the scroll key and selection keys, select **Standby mode** > **Shortcuts**. These shortcuts are not available in the active standby.

To assign shortcuts to applications, select **Standby mode** > **Standby apps**.

To select whether to show or hide the operator logo, select **Operator logo** > **On** or **Off**.

To select the Inbox or the mailbox that is shown in the active standby, select **Standby mode** > **Active standby mailbox**.

To select the plug-ins that are shown in the active standby, select **Standby mode** > **Active standby plug-ins**. You can, for example, see how many voice mails you have. The available plug-ins may vary.

#### Tone settings

To select a ringing tone for voice or video calls, select **Tones** > **Ringing tone** or **Video call tone**.

To set the ringing type, select **Tones** > **Ringing type**. You can also set the device to sound a ringing tone that is a combination of the spoken name of the caller and the selected ringing tone, when someone from your contacts list calls you. Select **Tones** > **Say caller's name**.

To set the volume level of the ringing tone, select **Tones** > **Ringing volume**.

## Settings

To set the various alert tones, select **Tones** > **Message alert tone**, **E-mail alert tone**, **Calendar alarm tone**, or **Clock alarm tone**.

To set the device to vibrate when you receive a call, select **Tones** > **Vibrating alert**.

To set the volume level of the device keypad tones, select **Tones** > **Keypad tones**.

To set the warning tones on or off, select **Tones** > **Warning tones**.

### Language settings

To set the language used on the device display, select **Language** > **Phone language**.

To select the language in which you write notes and messages, select **Language** > **Writing language**.

To select whether to use the predictive text input, select **Language** > **Predictive text**. To reset the predictive text dictionary to its original state, select **Language** > **Reset predictiv. dict.**

### Date and time settings

Select  > **Tools** > **Settings** > **General** > **Date and time**.

Select from the following:

- **Time** — Enter the time.
- **Time zone** — Enter the time zone.
- **Date** — Enter the date.
- **Date format** — Change how the date is displayed.
- **Date separator** — Change the symbol that separates days, months, and years.
- **Time format** — Select the 12-hour or 24-hour clock system.
- **Time separator** — Select the symbol that separates hours and minutes.
- **Clock type** — Select **Analogue** or **Digital**.
- **Clock alarm tone** — Select the tone that you want to use for the alarm clock.
- **Workdays** — Select the days that are work days for you.
- **Network operator time** — Select **Auto-update** to update the time, date, and time zone information automatically (network service). This service may not be available in all networks.

### Enhancement settings

Select  > **Tools** > **Settings** > **General** > **Enhancement**.

With most enhancements, you can do the following:

To determine which profile is activated when you attach an enhancement to your device, select **Default profile**.

To let the device answer phone calls automatically after 5 seconds when an enhancement is attached, select **Automatic answer** > **On**. If the ringing type is set to **Beep once** or **Silent** in the selected profile, the automatic answer is disabled.

To illuminate the device while it is attached to an enhancement, select **Lights** > **On**.

### Device security

Select  > **Tools** > **Settings** > **General** > **Security**.

Define the following security settings:

- **Phone and SIM card** — Adjust the security settings for your device and SIM card.
- **Certificate management** — Manage your security certificates.
- **Track protected object** — Manage your transaction security.
- **Security module** — Manage your security module.

Avoid using codes that are similar to emergency numbers to prevent accidental dialing of the emergency number. Codes are shown as asterisks. When you change a code, enter the current code, then the new code twice.

### Device and SIM card security

To change the PIN/UPIN code, select **Phone and SIM card** > **PIN code**. The new code must be 4 to 8 digits long. The PIN/UPIN code protects your SIM/USIM card against unauthorized use and is provided with the SIM/USIM card. After three consecutive incorrect PIN/UPIN code entries, the code is blocked, and you need to use the PUK/UPIK code to unblock it before you can use the SIM/USIM card again.

To set the keypad to lock automatically after a defined period, select **Phone and SIM card** > **Keypad autolock period**.

To set a time-out after which the device is automatically locked and can be used only if the correct lock code is entered, select **Phone and SIM card** > **Phone autolock period**. Enter a number for the time-out in minutes, or select **None** to set off the autolock period. When the device is locked, you can still answer incoming calls, and calls may still be possible to the official emergency number programmed into your device.

## Settings

To set a new lock code, select **Phone and SIM card** > **Lock code**. The preset lock code is 12345. Enter the old code and then the new code twice. The new code can be 4-255 characters long. Both alphabets and digits can be used, and both uppercase and lowercase alphabets are possible. The device notifies you if the lock code is not properly formatted.

To set the device to ask for the lock code when an unknown, new SIM card is inserted into your device, select **Phone and SIM card** > **Lock if SIM card changed**. The device maintains a list of SIM cards that are recognized as the owner's cards.

### Restore original settings

To restore the original device settings, select **Factory settings**. To do this, you need your device lock code. After resetting, the device may take a longer time to power on. Documents, contact information, calendar entries, and files are unaffected.

## ■ Telephone settings

Select  > **Tools** > **Settings** > **Phone**.

Select from the following:

- **Call** — Define general call settings.
- **Call divert** — Define your call divert settings. [See "Call divert" on page 23.](#)
- **Call barring** — Define your call barring settings. [See "Call barring" on page 24.](#)
- **Network** — Adjust the network settings.

### Call settings

To display your phone number to the person you are calling, select **Call** > **Send my caller ID** > **Yes**. To let the network determine whether your caller ID is sent, select **Set by network**.

To display your net call address to the person you are calling using a net call, select **Call** > **Send my internet call ID** > **Yes**.

To be notified of a new incoming call while you have a call in progress, select **Call** > **Call waiting** > **Options** > **Activate**. To check if the function is active on the network, select **Options** > **Check status**.

To select whether net calls alert or not, select **Call** > **Internet call alert**. You are notified of missed net calls with a notification.

To set the default call type, select **Call** > **Default call type** and select **Voice call** if you make a GSM calls, or **Internet call** if you make net calls.

To send a text message automatically to the person who is calling you informing why you cannot answer the incoming call, select **Call** > **Reject call with SMS** > **Yes**. To set the text for the message, select **Call** > **Message text**.

### Network settings

Select  > **Tools** > **Settings** > **Phone** > **Network**.

To select the network mode, select **Network mode** and **Dual mode**, **UMTS**, or **GSM**. In the dual mode, the device switches automatically between networks.

To select the operator, select **Operator selection** and **Manual** to choose from available networks, or **Automatic** to have the device select the network automatically.

To set the device to indicate when it is used in Micro Cellular Network (MCN), select **Cell info display** > **On**.

## ■ Connection settings

Select  > **Tools** > **Settings** > **Connection**.

Select from the following:

- **Access points** — Set up new or edit existing access points. Some or all access points may be preset for your device by your service provider, and you may not be able to create, edit, or remove them.
- **Packet data** — Determine when packet data connections are used, and enter the access point if you use your device as a modem for a computer.
- **Wireless LAN** — Determine if the device displays an indicator when a WLAN is available, and how often the device searches for networks.
- **Data call** — Set the time-out period after which data call connections automatically end.
- **SIP settings** — View or create session initiation protocol (SIP) profiles.
- **Internet tel.** — Define settings for net calls.
- **Configurations** — View and delete trusted servers from which your device may receive configuration settings.

To obtain information about WLAN or subscribing to a packet data service and the appropriate connection and configuration settings, contact your service provider.

The settings available for editing may vary.

## Access points

Select [☰](#) > [Tools](#) > [Settings](#) > [Connection](#) > [Access points](#).

An access point is where your device connects to the network by way of a data connection. To use e-mail and multimedia services or to browse web pages, you must first define access points for these services.

Some or all access points may be preset for your device by your service provider, and you may not be able to create, edit, or remove them.

To create a new access point, select [Options](#) > [New access point](#) or select an existing access point from the list and then [Options](#) > [Duplicate access point](#) to use the access point as a basis for the new one.

## Packet data settings

Select [☰](#) > [Tools](#) > [Settings](#) > [Connection](#) > [Packet data](#).

Your device supports packet data connections, such as GPRS in the GSM network. When you are using your device in GSM and UMTS networks, it is possible to have multiple data connections active at the same time; access points can share a data connection, and data connections remain active, for example, during voice calls. See "[Connection manager](#)" on page 44.

To define the packet data settings, select [Packet data connection](#) and select [When available](#) to register the device to the packet data network when you switch the device on in a supported network, or [When needed](#) to establish a packet data connection only when an application or action requires it. Select [Access point](#) and enter the access point name provided by your service provider to use the device as a packet data modem to your computer.

These settings affect all access points for packet data connections.

## WLAN settings

Select [☰](#) > [Tools](#) > [Settings](#) > [Connection](#) > [Wireless LAN](#).

To have an indicator displayed when there is a WLAN available in your current location, select [Show WLAN availability](#) > [Yes](#).

To select the interval for your device to scan for available WLANs and update the indicator, select [Scan for networks](#). This setting is not visible unless you select [Show WLAN availability](#) > [Yes](#).

To check the unique media access control (MAC) address that identifies your device, enter \*#62209526# in the standby mode. The MAC address is shown on the device display.

## Advanced WLAN settings

Select [Options](#) > [Advanced settings](#). The advanced WLAN settings are normally defined automatically, and changing them is not recommended.

To edit the settings manually, select [Automatic configuration](#) > [Disabled](#), and define the following:

- [Long retry limit](#) — Enter the maximum number of transmission attempts if the device does not receive a receiving acknowledgement signal from the network.
- [Short retry limit](#) — Enter the maximum number of transmission attempts if the device does not receive a clear-to-send signal from the network.
- [RTS threshold](#) — Select the data packet size at which the WLAN access point device issues a request to send before sending the packet.
- [Show WLAN availability](#) — Set the device to indicate when WLAN is available.
- [TX power level](#) — Select the power level of your device when sending data.
- [Radio measurements](#) — Enable or disable the radio measurements.
- [Power saving](#) — Select whether to save the power in the device battery.

To restore all settings to their original values, select [Options](#) > [Restore defaults](#).

## WLAN security settings

Select [Access points](#) > [Options](#) > [New access point](#), or select an access point and [Options](#) > [Edit](#).

In the access point settings, select [WLAN security mode](#) and the desired mode.

## WEP security settings

Select [Access points](#) > [Options](#) > [New access point](#), or select an access point and [Options](#) > [Edit](#).

In the access point settings, select [WLAN security mode](#) > [WEP](#).

The wired equivalent privacy (WEP) encryption method encrypts data before it is transmitted. Access to the network is denied to users who do not have the required WEP keys. When the WEP security mode is in use, and your device receives a data packet not encrypted with the WEP keys, the data is discarded.

In an [Ad-hoc](#) network, all devices must use the same WEP key.

## Settings

Select **WLAN security settings** and from the following:

- **WEP key in use** — Select the desired WEP key.
- **Authentication type** — Select **Open** or **Shared**.
- **WEP key settings** — Edit the settings for the WEP key.

### WEP key settings

In the access point settings, select **WLAN security mode** > **WEP**.

Select **WLAN security settings** > **WEP key settings** and from the following:

- **WEP encryption** — Select the desired WEP encryption key length.
- **WEP key format** — Select whether you want to enter the WEP key data in **ASCII** or **Hexadecimal** format.
- **WEP key** — Enter the WEP key data.

### 802.1x security settings

In the access point settings, select **WLAN security mode** > **802.1x**.

**802.1x** authenticates and authorizes devices to access a wireless network, and prevents access if the authorization process fails.

Select **WLAN security settings** and from the following:

- **WPA/WPA2** — Select **EAP** (Extensible Authentication Protocol) or **Pre-shared key** (a secret key used for device identification).
- **EAP plug-in settings** — If you selected **WPA/WPA2** > **EAP**, select which EAP plug-ins defined in your device to use with the access point.
- **Pre-shared key** — If you selected **WPA/WPA2** > **Pre-shared key**, enter the shared private key that identifies your device to the WLAN to which you connect.

The settings available for editing may vary.

### WPA security settings

In the access point settings, select **WLAN security mode** > **WPA/WPA2**.

Select **WLAN security settings** and from the following:

- **WPA/WPA2** — Select **EAP** (Extensible Authentication Protocol) or **Pre-shared key** (a secret key used for device identification).
- **EAP plug-in settings** — If you select **WPA/WPA2** > **EAP**, select which EAP plug-ins defined in your device to use with the access point.
- **Pre-shared key** — If you select **WPA/WPA2** > **Pre-shared key**, enter the shared private key that identifies your device to the WLAN to which you connect.
- **WPA2 only mode** — To enable TKIP encryption, based on transient keys changed often enough to prevent misuse, select **Off**. All devices in the WLAN must either allow or prevent the use of TKIP encryption.

The settings available for editing may vary.

## EAP

Select  > **Tools** > **Settings** > **Connection** > **Access points**.

The EAP (extensible authentication protocol) plug-ins are used in wireless networks to authenticate wireless devices and authentication servers, and the different EAP plug-ins make possible the use of various EAP methods (network service).

You can view the EAP plug-ins currently installed in your device (network service).

1. To define the EAP plug-in settings, select **Options** > **New access point** and define an access point that uses WLAN as a data bearer.
2. Select **802.1x** or **WPA/WPA2** as the security mode.
3. Select **WLAN security settings** > **WPA/WPA2** > **EAP** > **EAP plug-in settings**.

To use an EAP plug-in when you connect to a WLAN using the access point, select the desired plug-in and **Options** > **Enable**. The EAP plug-ins enabled for use with this access point have a check mark next to them. To not use a plug-in, select **Options** > **Disable**.

To edit the EAP plug-in settings, select **Options** > **Edit**.

To change the priority of the EAP plug-in settings, select **Options** > **Raise priority** to attempt to use the plug-in before other plug-ins when connecting to the network with the access point, or **Options** > **Lower priority** to use this plug-in for network authentication after attempting to use other plug-ins.

See the device help for more information on EAP plug-ins.

### Data call settings

Select  > **Tools** > **Settings** > **Connection** > **Data call**.

## Settings

To set the time-out period after which data calls automatically end if no data has been transferred, select **Online time**. Select **User defined** to enter the time yourself or **Unlimited** to keep the connection active until you select **Options** > **Disconnect**.

### Session initiation protocol (SIP) settings

Select  > **Tools** > **Settings** > **Connection** > **SIP settings**.

Session initiation protocols (SIP) are used for creating, modifying, and terminating certain types of communication sessions with one or more participants (network service). SIP profiles include settings for these sessions. The SIP profile used by default for a communication session is underlined.

To create a SIP profile, select **Options** > **New SIP profile** > **Use default profile** or **Use existing profile**.

To select the SIP profile you want to use by default for communication sessions, select **Options** > **Default profile**.

### Edit SIP profiles

Select **SIP settings** > **Options** > **New SIP profile** or **Edit**, and select from the following:

- **Profile name** — Enter a name for the SIP profile.
- **Service profile** — Select **IETF** or **Nokia 3GPP**.
- **Default access point** — Select the access point to use for the internet connection.
- **Public user name** — Enter your user name received from your service provider.
- **Use compression** — Select if compression is used.
- **Registration** — Select the registration mode.
- **Use security** — Select if security negotiation is used.
- **Proxy server** — Enter the proxy server settings for this SIP profile.
- **Registrar server** — Enter the registration server settings for this SIP profile.

The settings available for editing may vary.

### Edit SIP proxy servers

Select **SIP settings** > **Options** > **New SIP profile** or **Edit** > **Proxy server**.

Proxy servers are intermediate servers between a browsing service and its users used by some service providers. These servers may provide additional security and speed up access to the service.

Select from the following:

- **Proxy server address** — Enter the host name or IP address of the proxy server in use.
- **Realm** — Enter the proxy server realm.
- **User name** and **Password** — Enter your user name and password for the proxy server.
- **Allow loose routing** — Select if loose routing is allowed.
- **Transport type** — Select **UDP** or **TCP**.
- **Port** — Enter the port number of the proxy server.

### Edit registration servers

Select **SIP settings** > **Options** > **New SIP profile** or **Edit** > **Registrar server**.

Select from the following:

- **Registrar server address** — Enter the host name or IP address of the registrar server in use.
- **Realm** — Enter the registrar server realm.
- **User name** and **Password** — Enter your user name and password for the registrar server.
- **Transport type** — Select **UDP** or **TCP**.
- **Port** — Enter the port number of the registrar server.

### Net call settings

Select  > **Tools** > **Settings** > **Connection** > **Internet tel..**

To create a new net call profile, select **Options** > **New profile**.

To edit an existing profile, select **Options** > **Edit**.

### Configurations

Select  > **Tools** > **Settings** > **Connection** > **Configurations**.

You can receive messages from your service provider or company information management containing configuration settings for trusted servers. These settings are automatically saved in **Configurations**. You may receive configuration settings for access points, multimedia, or e-mail services, and IM or synchronization settings from trusted servers.

## Settings

To delete configurations for a trusted server, select [Options](#) > [Delete](#). The configuration settings for other applications provided by this server are also deleted.

### ■ Application settings

Select  > [Tools](#) > [Settings](#) > [Applications](#).

Select an application from the list.

## 18. Device and data management

---

### ■ Back up data

It is recommended to back up device memory regularly to the memory card or a compatible computer.

To back up information from the device memory to a memory card, select  > **Tools** > **Memory** > **Options** > **Back up phone memory**.

To restore information from the memory card to the device memory, select  > **Tools** > **Memory** > **Options** > **Restore from card**.

You can also connect your device to a compatible computer and use Nokia PC Suite to back up data.

### ■ Remote configuration

Select  > **Tools** > **Device mgr.**.

With Device manager, you can manage data and software on your device.

You can connect to a server, and receive configuration settings for your device. You may receive server profiles and different configuration settings from your service providers or company information management department. Configuration settings may include connection and other settings used by different applications in your device. Available options may vary.

The remote configuration connection is usually started by the server when the device settings need to be updated.

To create a new server profile, select **Options** > **New server profile**.

Define the following settings:

- **Server name** — Enter a name for the configuration server.
- **Server ID** — Enter the unique ID to identify the configuration server.
- **Server password** — Enter a password to identify your device to the server.
- **Session mode** — Select the preferred connection type.
- **Access point** — Select the access point to use for the connection, or create a new access point. You can also choose to be asked for the access point every time you start a connection.
- **Host address** — Enter the web address of the configuration server.
- **Port** — Enter the port number of the server.
- **User name** — Enter your user ID for the configuration server.
- **Password** — Enter your password for the configuration server.
- **Allow configuration** — Select **Yes** to allow the server to initiate a configuration session.
- **Auto-accept all requests** — Select **Yes** if you do not want the server to ask for your confirmation when it initiates a configuration session.
- **Network authentication** — Select whether to use http authentication. This setting is available only if you have selected internet as the bearer type.
- **Network user name** — Enter your user ID for the http authentication. This setting is available only if you have selected internet as the bearer type.
- **Network password** — Enter your password for the http authentication. This setting is available only if you have selected internet as the bearer type.

To connect to the server and receive configuration settings for your device, select **Options** > **Start configuration**.

To view the configuration log of the selected profile, select **Options** > **View log**.

### ■ Application manager

Select  > **Installations** > **App. mgr.**.

With Application manager, you can see the software packages that have been installed, with their name, version number, type, and size. You can view the details of installed applications, remove them from your device, and specify installation settings.



**Important:** Only install and use applications and other software from trusted sources, such as applications that are Symbian Signed or have passed the Java Verified™ testing.

### Install applications

You can install two types of applications and software on your device:

- Applications and software specifically intended for your device or compatible with the Symbian operating system. These software installation files have the extension .sis.



## Device and data management

- J2ME™ applications compatible with the Symbian operating system. The Java application installation file extensions are .jad or .jar.

Installation files may be transferred to your device from a compatible computer, downloaded during browsing, or sent to you in a multimedia message, as an e-mail attachment, or with Bluetooth. If you use Nokia PC Suite to transfer a file to your device, save the file in the C:\nokia\installs folder on your computer.

During the installation, the device checks the integrity of the package to be installed. The device shows information about the checks being carried out, and you are given options to continue or cancel the installation.

If you install applications that require a network connection, note that the power consumption of your device may increase when you use these applications.



**Tip:** When browsing web pages, you can download an installation file and install it immediately. Note, however, that the connection runs in the background during the installation.

To download and install software from the web, select **Download applications**. Select the application and **Options** > **Install**.

To view the details of an installed software package, select the application and **Options** > **View details**.

To view the installation log, select **Options** > **View log**. A list shows what software has been installed and removed, and the date of the installation or removal. If you encounter problems with the device after installing a software package, use this list to find out which software package may be the cause of the problem. The information in this list may also help you pinpoint problems that are caused by software packages that are incompatible with each other.

To remove software, select **Options** > **Remove**. If you remove software, you can only reinstall it by using the original software package file, or by restoring a full backup that contains the removed software package. If you remove a software package, you may no longer be able to open files created with that software. If another software package depends on the software package that you removed, the other software package may stop working. Refer to the documentation of the installed software package for details.

## Installation settings

To modify installation settings, select **Options** > **Settings** and from the following:

- **Delete** — The software package installation file is deleted from the device after the installation. If you download software packages using the Web browser, this may help reduce the amount of storage space required. If you want to store the software package file for possible reinstallation, do not select this option, or make sure that you have a copy of the software package file stored on a compatible computer or on a CD-ROM.
- **Select language:** — If the software package contains several language versions of the software, select the language version that you want to install.
- **Type** — Specify what kind of applications you want installed. You may choose to install only applications with validated certificates. This setting applies only to Symbian operating system applications (.sis files).

## Java security settings

To specify security settings for a Java application, select  > **Installations** > **Application manager** > **Options** > **Settings**.

You can define which functions the Java application can access. The value that you can set for each functionality depends on the protection domain of the software package.

- **Network access** — Create a data connection to the network.
- **Messaging** — Send messages.
- **Application auto-start** — Open the application automatically.
- **Connectivity** — Activate a local data connection, such as a Bluetooth connection.
- **Multimedia** — Capture images or record videos or sound.
- **Read user data** — Read your calendar entries, contacts, or any other personal data.
- **Edit user data** — Add personal data, such as entries to Contacts.

You can define how you are prompted to confirm the Java application's access to the device functions. Select one of the following values:

- **Ask every time** — Require the Java application to ask for your confirmation each time it uses the functionality.
- **Ask first time** — Require the Java application to ask for initial confirmation to use the functionality.
- **Always allowed** — Allow the Java application to use the functionality without your confirmation. The security settings help protect your device against harmful Java applications that may use the functions of your device without your permission. Only select **Always allowed** if you know the supplier and trustworthiness of the application.
- **Not allowed** — Prevent the Java application from using the functionality.

## ■ Activation keys

Select  > **Tools** > **Actv. keys**.

## Device and data management

Some media files, such as images, music, or video clips, are protected by digital usage rights. The activation keys for such files may allow or restrict their usage. For example, with some activation keys you may listen to a music track only a limited number of times. During one playback session you may rewind, fast-forward, or pause the track, but once you stop it, you have used one of the instances allowed.

To view your activation keys by type, select [Valid keys](#), [Invalid keys](#), or [Not in use](#).

To view the key details, select [Options](#) > [Key details](#).

The following details are displayed for each media file:

- **Status** — The status is either [Activation key is valid](#), [Activation key expired](#), or [Activation key not yet valid](#).
- **Content sending** — [Allowed](#) means that you can send the file to another device. [Not allowed](#) means that you cannot send the file to another device.
- **Content in phone** — [Yes](#) means that the file is in the device and the path of the file is displayed. [No](#) means that the related file is not currently in the device.

To activate a key, go to the main view of the activation keys, and select [Invalid keys](#) > [Options](#) > [Get activation key](#). Establish a network connection at the prompt, and you are directed to a web site where you can purchase rights to the media.

To remove file rights, open the valid keys tab or the keys not in use tab, scroll to the desired file, and select [Options](#) > [Delete](#). If there are several rights related to the same media file, all the rights are deleted.

The group key view displays all of the files related to a group right. If you have downloaded multiple media files with the same rights, they are all displayed in this view. You can open the group view from either the valid keys or invalid keys tabs. To access these files, open the group rights folder.

To rename a group, select [Options](#) > [Rename](#). Enter the new name to change the name of the group rights.

## ■ Data synchronization

Select [Tools](#) > [Sync](#).

With Sync, you can synchronize your contacts, calendar entries, notes, or mailboxes with corresponding applications on a compatible computer or remote internet server. Your synchronization settings are saved in a synchronization profile. The Sync application uses SyncML technology for remote synchronization. For information on SyncML compatibility, contact the supplier of the applications with which you want to synchronize your device.

You may receive the synchronization settings as a message from your service provider. The available applications you can synchronize may vary. Contact your service provider for more information.

### Create a synchronization profile

To create a profile, select [Options](#) > [New sync profile](#) and assign a name for the profile, select the applications to synchronize with the profile, and specify the needed connection settings. Contact your service provider for details.

### Select applications to synchronize

1. To select the applications to synchronize with a synchronization profile, select [Options](#) > [Edit sync profile](#) > [Applications](#).
2. Select the desired application, and select [Include in sync](#) > [Yes](#).
3. Specify the [Remote database](#) and [Synchronisation type](#) settings.

### Synchronization connection settings

To define the connection settings of a new profile, select [New sync profile](#) > [Connection settings](#) and define the following settings:

- **Server version** — Select the SyncML version you can use with your e-mail server.
- **Server ID** — Enter the server ID of your e-mail server. This setting is only available if you select 1.2 as the SyncML version.
- **Data bearer** — Select the data bearer to connect to the remote database during synchronization.
- **Access point** — Select the access point to use for the synchronization connection, or create a new access point. You can also choose to be asked for the access point every time you start synchronizing.
- **Host address** — Enter the web address of the server that contains the database with which you want to synchronize your device.
- **Port** — Enter the port number of the remote database server.
- **User name** — Enter your user name to identify your device to the server.
- **Password** — Enter your password to identify your device to the server.
- **Allow sync requests** — To allow synchronization to start from the remote database server, select [Yes](#).
- **Accept all sync requests** — To have your device ask for your confirmation before accepting synchronization from the server, select [No](#).

## Device and data management

- **Network authentication** — To authenticate your device to the network before synchronization, select **Yes**. Enter your network user name and network password.

### ■ Barcode reader

Select  > **Tools** > **Barcode**.

Use the Barcode application to decode different types of codes, such as barcodes and codes in magazines. The codes may contain information such as web addresses, e-mail addresses, and phone numbers. These are indicated by icons on the top of the display in the direction they appear in the decoded information.

The Barcode application uses the camera in your device to scan codes.

To scan the code with the camera, select **Scan code**. Set the code between the red lines on the display. The decoded information appears on the display.

To save the scanned data, select **Options** > **Save**. The data is saved in .bcr format.

To view previously saved, decoded information, select **Saved data**. To open a code, press the scroll key.

The device reverts to the standby mode to save battery power if no keys are pressed for 1 minute. To continue scanning or viewing saved information, press the scroll key.

### ■ Download!

Select  > **Download!**

With Download! (network service), you can browse, download, and install items, such as latest applications and related documents, to your device from the web.

The items are categorized under catalogs and folders provided by Nokia or independent service providers. Some items may be chargeable, but you can usually preview them free of charge.

Only install and use applications and other software from sources that offer adequate security and protection against harmful software.

#### Select catalogs, folders, and items

To update the Download! content, select **Options** > **Refresh list**.

To hide a folder or a catalog from the list, for example, to view only items that you use frequently, select **Options** > **Hide**. To make the items visible again, select **Options** > **Show all**.

To buy the selected item, select **Options** > **Buy**. A submenu opens, where you can select the version of the item, and view price information.

To download an item that is free of charge, select **Options** > **Get**.

To view the details of the selected item, select **Options** > **View details**.

To return to the Download! main level, select **Options** > **Homepage**.

The available options may vary depending on your service provider, the selected item, and the view you are in.

#### Download! settings

To change the Download! settings, select **Options** > **Settings**, and from the following:

- **Access point** — Select an access point to use to connect to the service provider's server.
- **Automatic open** — Select whether you want the downloaded item or application to open automatically after the download is completed.
- **Preview confirmation** — Select whether you want the preview confirmation query to be shown before previewing an item.
- **Buy confirmation** — Select whether you want the purchase confirmation query to be shown before buying an item.

## 19. Security

---

### ■ Fixed dialing

Select  > [Contacts](#) > [Options](#) > [SIM contacts](#) > [Fixed dial contacts](#).

With the fixed dialing service, you can restrict calls from your device to certain phone numbers. Not all SIM cards support the fixed dialing service. Contact your service provider for more information.

When fixed dialing is activated, calls may be possible to the official emergency number programmed into your device.

1. To restrict calls from your device, select [Options](#) > [New SIM contact](#) and enter the contact name and phone number to the list of numbers to which calls are allowed, or select [Add from Contacts](#) to copy the contact from Contacts. To restrict calls by a country prefix, enter the country prefix in the list of numbers. All phone numbers to which calls are allowed must start with this country prefix.
2. Select [Options](#) > [Activate fixed dialing](#). You need your PIN2 code to activate and deactivate fixed dialing or edit your fixed dialing contacts. Contact your service provider if you do not have the code. To cancel the service, select [Options](#) > [Deactivate fixed dialing](#).



**Tip:** To send text messages to the SIM contacts while the fixed dialing service is active, you need to add the text message center number to the fixed dialing list.

### ■ Certificate manager



**Important:** Even if the use of certificates makes the risks involved in remote connections and software installation considerably smaller, they must be used correctly in order to benefit from increased security. The existence of a certificate does not offer any protection by itself; the certificate manager must contain correct, authentic, or trusted certificates for increased security to be available. Certificates have a restricted lifetime. If "Expired certificate" or "Certificate not valid yet" is shown even if the certificate should be valid, check that the current date and time in your device are correct.

Before changing any certificate settings, you must make sure that you really trust the owner of the certificate and that the certificate really belongs to the listed owner.

Select  > [Tools](#) > [Settings](#) > [General](#) > [Security](#) > [Certificate management](#).

Digital certificates are used to verify the origins of software but do not guarantee safety. There are three different types of certificates: authority certificates, personal certificates, and server certificates. During a secure connection, a server may send a server certificate to your device. Upon receipt, it is checked through an authority certificate stored on your device. You receive notification if the identity of the server is not authentic or if you do not have the correct certificate in your device.

Download a certificate from a web site, or receive a certificate as an e-mail attachment, or as a message sent through a Bluetooth or infrared connection. Certificates should be used when you connect to an online bank or a remote server to transfer confidential information. They should also be used if you want to reduce the risk of viruses or other malicious software, and to check the authenticity of software when you download and install software to your device.



**Tip:** When you add a new certificate, check its authenticity.

### Certificate trust settings

Trusting a certificate means that you authorize it to verify web pages, e-mail servers, software packages, and other data. Only trusted certificates can be used to verify services and software.

To change trust settings, select a certificate and [Options](#) > [Trust settings](#). Select an application field and [Yes](#) or [No](#). You cannot change the trust settings of a personal certificate.

Depending on the certificate, a list of applications that can use the certificate is displayed:

- [Symbian installation](#) — New Symbian operating system application.
- [Internet](#) — E-mail and graphics.
- [App. installation](#) — New Java™ application.
- [Online certif. check](#) — Online certificate status protocol.

### View certificate details

You can only be sure of the correct identity of a server when the signature and the validity period of a server certificate have been checked.

To view certificate details, select [View details](#).

One of the following notes may appear:

## Security

- **Certificate not trusted** — You have not set any application to use the certificate. You may want to change the trust settings.
- **Expired certificate** — The period of validity has ended for the selected certificate.
- **Certificate not valid yet** — The period of validity has not yet begun for the selected certificate.
- **Certificate corrupted** — The certificate cannot be used. Contact the certificate issuer.

### ■ Security modules

Select  > **Tools** > **Settings** > **General** > **Security** > **Security module**.

To view or edit a security module, scroll to it, and press the scroll key.

To view detailed information about a security module, select **Options** > **Security details**.

The key store contains the contents of the security module. To delete the key store, select **Key store**, select the desired key store, and **Options** > **Delete**. You may not be able to delete the key store of all security modules.

### Security module codes

Select  > **Tools** > **Settings** > **General** > **Security** > **Security module**.

To edit the PIN codes for the security module, select **Module PIN** to edit the PIN code for the security module or **Signing PIN** to edit the PIN code for digital signatures. You may not be able to change these codes for all security modules.

To view detailed information about the security module, select **Options** > **Security details**.

### ■ Memory card security

Select  > **Tools** > **Memory**.

You can protect a memory card with a password to prevent unauthorized access. To set a password, select **Options** > **Set password**. The password can be up to eight characters long and is case-sensitive. The password is stored in your device. You do not need to enter it again while you use the memory card on the same device. If you use the memory card on another device, you are asked for the password. Not all memory cards support password protection.

To remove the memory card password, select **Options** > **Remove password**. When you remove the password, the data on the memory card is not protected against unauthorized use.

To open a locked memory card, select **Options** > **Unlock memory card**. Enter the password.

If you cannot recall the password to unlock a locked memory card, you may reformat the card, in which case the card is unlocked and password removed. Formatting a memory card destroys all data stored on the card.

### ■ Lock the device

When the device is locked, calls may be possible to the official emergency number programmed into your device.

To prevent access to the contents of your device, lock the device in the standby mode. Press the power key, select **Lock phone**, and enter your lock code. The default lock code is 12345. To unlock, press the left selection key, enter your lock code, and press the scroll key.

You can also lock the device remotely by sending a text message to the device. To enable remote locking and to define the text for the message, select  > **Tools** > **Settings** > **General** > **Security** > **Phone and SIM card** > **Allow remote lock** > **Yes**. Enter the remote lock message and confirm the message. The message must be at least 5 characters long.

To change the lock code, select  > **Tools** > **Settings** > **General** > **Security** > **Phone and SIM card** > **Lock code**. Enter the old code and then the new code twice. The new code can be 4-255 characters long. Both alphabets and digits can be used, and both uppercase and lowercase alphabets are possible.

## 20. Shortcuts

Here are some of the available keyboard shortcuts in your device. Shortcuts can make the use of the applications more efficient.

### General shortcuts

|           |  |
|-----------|--|
| Power key | Press and hold to switch your device on and off.<br>Press once to switch between profiles.   |
| Menu key  | Press once to open the main menu for access to all applications.<br>Press and hold to bring up a list of open applications. To navigate between the open applications, select an application. To close open applications, select an application, and press the backspace key . |

### Active standby mode

|                        |   |
|------------------------|---|
| Left selection key + * | Lock and unlock the keypad.   |
| Call key               | Open the call log.  |
| 0                      | Press and hold to open your home page in the Web browser.   |
| #                      | Press and hold to switch between the <b>Silent</b> and <b>General</b> profiles.   |
| 1                      | Press and hold to call your voice mailbox.  |
| Number key (2–9)       | Call a phone number using speed dialing. You must first activate speed dialing at <a href="#">Tools</a> > <a href="#">Settings</a> > <a href="#">Phone</a> > <a href="#">Call</a> > <a href="#">Speed dialling</a> > <a href="#">On</a> . |

### Web

|   |   |
|---|---|
| * | Zoom in the page.                               |
| # | Zoom out the page.                              |
| 2 | Open the search dialog.                         |
| 5 | View the active pages.                          |
| 8 | View the page overview.                         |
| 9 | Open the dialog for entering a new web address. |
| 0 | Open the Bookmarks folder.                      |

### Image viewer

|          |  |
|----------|--|
| Call key | Send the image.                                      |
| 0        | Zoom out.  |
| 5        | Zoom in.   |
| 7        | Zoom in. Press twice for the full screen size.       |
| 4        | Scroll left in the zoomed image.                     |
| 6        | Scroll right in the zoomed image.                    |
| 2        | Scroll up in the zoomed image.                       |
| 8        | Scroll down in the zoomed image.                     |
| 3        | Rotate clockwise.                                    |
| 1        | Rotate counterclockwise.                             |
| *        | Switch between the full screen size and normal view. |

### Editing shortcuts

|           |   |
|-----------|---|
| Chr key   | Press once to view a table of special characters not found on the keypad. |
| Chr + tab | Switch between open applications.   |
| Ctrl+A    | Select all.   |
| Ctrl+C    | Copy.   |

## Shortcuts

|                             |  |
|-----------------------------|--|
| Ctrl+V                      | Paste.   |
| Ctrl+X                      | Cut.   |
| Ctrl+Z                      | Undo.  |
| Ctrl + scroll right         | Move the focus one word forward.                           |
| Ctrl + scroll left          | Move the focus one word backward.                          |
| Chr + scroll right          | Move to the end of the line.                               |
| Chr + scroll left           | Move to the start of the line.                             |
| Chr + scroll up             | Page up.   |
| Chr + scroll down           | Page down.   |
| Ctrl + chr + scroll up      | Move to the start of the document.                         |
| Ctrl + chr + scroll down    | Move to the end of the document.                           |
| Shift + scroll right        | Select the next character on the right.                    |
| Shift + scroll left         | Select the next character on the left.                     |
| Ctrl + shift + scroll right | Select the next word on the right.                         |
| Ctrl + shift + scroll left  | Select the next word on the left.                          |
| Shift + backspace           | Delete text from the right.                                |
| Chr + alphabet              | Insert an accented character.                              |
| Shift + chr                 | Change the writing language.                               |
| Shift + scroll up           | Select all the text on top and/or left side of the cursor. |
| Shift + scroll down         | Select all the text below and/or right side of the cursor. |

## 21. Glossary

---

|                               |  |
|-------------------------------|--|
| 3G                            | 3rd generation mobile communications. A digital system for mobile communications which aims at global use and provides increased bandwidth. 3G lets a mobile device user access a wide variety of services, such as multimedia.  |
| Ad-hoc operating mode         | In a wireless LAN, the ad hoc operating mode allows you to send and receive data from other devices with compatible wireless LAN support. These functions may require an additional third party application to work. No wireless LAN access point is required. Simply make the necessary configurations and start communicating. Ad hoc networking is easy to set up, but communication is limited to devices that are within range and support compatible wireless LAN technology.  |
| Cookies                       | Cookies are little pieces of information, given by the server to you, to store information about your visits to a web site. When you accept cookies, the server is able to evaluate your use of the web site, what you are interested in, what you want to read, and so on.  |
| DNS                           | Domain name service. An internet service that translates domain names such as www.nokia.com into IP addresses such as 192.100.124.195. Domain names are easier to remember but this translation is needed because the internet is based on IP addresses.   |
| DTMF tones                    | Dual Tone Multi-Frequency tones. The DTMF system is used by touch-tone telephones. DTMF assigns a specific frequency, or tone, to each key so that it can easily be identified by a microprocessor. DTMF tones allow you to communicate with voice mailboxes, computerized telephony systems, and so on.   |
| EAP                           | Extensible authentication protocol. EAP plug-ins are used in wireless networks to authenticate wireless devices and authentication servers.  |
| EGPRS                         | Enhanced GPRS. EGPRS is similar to GPRS, but it enables faster connection. For more information on the availability of EGPRS and data transfer speed, contact your service provider.   |
| GPRS                          | General packet radio service. GPRS enables wireless access for mobile phones to data networks (network service). GPRS uses packet data technology where information is sent in short bursts of data over the mobile network. The benefit of sending data in packets is that the network is occupied only when sending or receiving data. As GPRS uses the network efficiently, it allows for quick data connection setup and fast data transmission speeds.<br>You must subscribe to the GPRS service. For availability and subscription to GPRS, contact your service provider.<br>During a voice call, you cannot establish a GPRS connection, and any existing GPRS connection is put on hold unless the network supports dual transfer mode. |
| GPS                           | Global positioning system. GPS is a worldwide radio navigation system.   |
| HSDPA                         | High-speed downlink packet access. HSDPA brings high-speed data delivery to 3G terminals, ensuring that users requiring effective multimedia capabilities benefit from data rates previously unavailable because of limitations in the radio access network.   |
| HTTP                          | Hypertext transfer protocol. A document transfer protocol used in the web.   |
| HTTPS                         | HTTP over a secure connection.   |
| IMAP4                         | Internet mail access protocol, version 4. A protocol used for accessing your remote mailbox.   |
| Internet access point         | An access point is where your device connects to a network. To use e-mail and multimedia services or to connect to the internet and browse web pages, you must first define internet access points for these services.   |
| Infrastructure operating mode | The infrastructure operating mode allows two kinds of communication: wireless devices communicate with each other through a wireless LAN access point or wireless devices communicate with a wired LAN device through a wireless LAN access point. The advantage of the infrastructure operating mode is that you can have more control over network connections because they pass through an access point. A wireless device can access the services that are available in a regular wired LAN: company database, e-mail, the Internet, and other network resources, for example.   |
| PIN                           | Personal identity number. The PIN code protects your device from unauthorized use. The PIN code is supplied with the SIM card. If the PIN code request is selected, the code is required each time the device is switched on. The PIN code must be 4 to 8 digits long.   |



## Glossary

|              |  |
|--------------|--|
| PIN2         | The PIN2 code is supplied with some SIM cards. The PIN2 code is required to access certain functions supported by the SIM card. The length of the PIN2 code is 4 to 8 digits.  |
| POP3         | Post office protocol, version 3. A common mail protocol that can be used for accessing your remote mailbox.  |
| SIP          | Session initiation protocol. SIP is used for creating, modifying, and terminating certain types of communication sessions with one or more participants.   |
| SSID         | Service set identifier. SSID is the name that identifies the specific wireless LAN.  |
| Streaming    | Streaming audio and video files means playing them directly from the web without downloading them first to your device.  |
| UMTS         | Universal mobile telecommunications system. UMTS is a 3G mobile communication system. Besides voice and data, UMTS enables audio and video delivery to wireless devices.<br>When you use your device in GSM and UMTS networks, multiple data connections can be active at the same time, and access points can share a data connection. In the UMTS network, data connections remain active during voice calls. You can, for example, browse the web faster than previously possible while simultaneously speaking on the phone.   |
| UPIN         | PIN code used in UMTS network.   |
| USIM         | SIM card used in UMTS network.   |
| USSD command | A service request, such as request to activate an application or configure various settings remotely, that you can send to your operator or service provider with your device.   |
| VoIP         | Voice over internet protocol technology. VoIP is a set of protocols that facilitate phone calls over an IP network, such as the internet.  |
| VPN          | Virtual private network. VPN creates a secure connection to compatible corporate intranet and services, such as e-mail.  |
| WAP          | Wireless application protocol. WAP is an international standard for wireless communication.  |
| WEP          | Wired equivalent privacy. WEP is an encryption method that encrypts data before it is transmitted in WLAN.   |
| WLAN         | Wireless local area network. A wireless LAN connection is established when you create a data connection using a wireless LAN internet access point. The active wireless LAN connection is ended when you end the data connection.<br>If you move the device to another location within the wireless LAN and out of range of a wireless LAN access point, the roaming functionality can automatically connect your device to another access point that belongs to the same network. As long as you remain within range of access points that belong to the same network, your device can stay connected to the network. |
| WPA          | Wi-Fi Protected Access. Security method for WLAN.  |
| WPA2         | Wi-Fi Protected Access 2. Security method for WLAN.  |

## Battery information

---

Your device is powered by a rechargeable battery. The battery can be charged and discharged hundreds of times, but it will eventually wear out. When the talk and standby times are noticeably shorter than normal, replace the battery. Use only Nokia approved batteries, and recharge your battery only with Nokia approved chargers designated for this device.

If a replacement battery is being used for the first time or if the battery has not been used for a prolonged period, it may be necessary to connect the charger, then disconnect and reconnect it to begin charging the battery.

Unplug the charger from the electrical plug and the device when not in use. Do not leave a fully charged battery connected to a charger, since overcharging may shorten its lifetime. If left unused, a fully charged battery will lose its charge over time.

If the battery is completely discharged, it may take several minutes before the charging indicator appears on the display or before any calls can be made.

Use the battery only for its intended purpose. Never use any charger or battery that is damaged.

Do not short-circuit the battery. Accidental short-circuiting can occur when a metallic object such as a coin, clip, or pen causes direct connection of the positive (+) and negative (-) terminals of the battery. (These look like metal strips on the battery.) This might happen, for example, when you carry a spare battery in your pocket or purse. Short-circuiting the terminals may damage the battery or the connecting object.

Leaving the battery in hot or cold places, such as in a closed car in summer or winter conditions, will reduce the capacity and lifetime of the battery. Always try to keep the battery between 15°C and 25°C (59°F and 77°F). A device with a hot or cold battery may not work temporarily, even when the battery is fully charged. Battery performance is particularly limited in temperatures well below freezing.

Do not dispose of batteries in a fire as they may explode. Batteries may also explode if damaged. Dispose of batteries according to local regulations. Please recycle when possible. Do not dispose as household waste.

Do not dismantle or shred cells or batteries. In the event of a battery leak, do not allow the liquid to come in contact with the skin or eyes. In the event of such a leak, flush your skin or eyes immediately with water, or seek medical help.

## Nokia battery authentication guidelines

---

Always use original Nokia batteries for your safety. To check that you are getting an original Nokia battery, purchase it from an authorised Nokia dealer, and inspect the hologram label using the following steps:

Successful completion of the steps is not a total assurance of the authenticity of the battery. If you have any reason to believe that your battery is not an authentic, original Nokia battery, you should refrain from using it, and take it to the nearest authorised Nokia service point or dealer for assistance. Your authorised Nokia service point or dealer will inspect the battery for authenticity. If authenticity cannot be verified, return the battery to the place of purchase.

### ■ Authenticate hologram

1. When you look at the hologram on the label, you should see the Nokia connecting hands symbol from one angle and the Nokia Original Enhancements logo when looking from another angle.



2. When you angle the hologram left, right, down and up, you should see 1, 2, 3 and 4 dots on each side respectively.



### ■ What if your battery is not authentic?

If you cannot confirm that your Nokia battery with the hologram on the label is an authentic Nokia battery, please do not use the battery. Take it to the nearest authorised Nokia service point or dealer for assistance. The use of a battery that is not approved by the manufacturer may be dangerous and may result in poor performance and damage to your device and its enhancements. It may also invalidate any approval or warranty applying to the device.

To find out more about original Nokia batteries, visit [www.nokia.com/battery](http://www.nokia.com/battery).

## Care and maintenance

---

Your device is a product of superior design and craftsmanship and should be treated with care. The following suggestions will help you protect your warranty coverage.

- Keep the device dry. Precipitation, humidity, and all types of liquids or moisture can contain minerals that will corrode electronic circuits. If your device does get wet, remove the battery, and allow the device to dry completely before replacing it.
- Do not use or store the device in dusty, dirty areas. Its moving parts and electronic components can be damaged.
- Do not store the device in hot areas. High temperatures can shorten the life of electronic devices, damage batteries, and warp or melt certain plastics.
- Do not store the device in cold areas. When the device returns to its normal temperature, moisture can form inside the device and damage electronic circuit boards.
- Do not attempt to open the device other than as instructed in this guide.
- Do not drop, knock, or shake the device. Rough handling can break internal circuit boards and fine mechanics.
- Do not use harsh chemicals, cleaning solvents, or strong detergents to clean the device.
- Do not paint the device. Paint can clog the moving parts and prevent proper operation.
- Use a soft, clean, dry cloth to clean any lenses, such as camera, proximity sensor, and light sensor lenses.
- Use only the supplied or an approved replacement antenna. Unauthorized antennas, modifications, or attachments could damage the device and may violate regulations governing radio devices.
- Use chargers indoors.
- Always create a backup of data you want to keep, such as contacts and calendar notes.
- To reset the device from time to time for optimum performance, power off the device and remove the battery.

These suggestions apply equally to your device, battery, charger, or any enhancement. If any device is not working properly, take it to the nearest authorized service facility for service.

### ■ Disposal



The crossed-out wheeled-bin symbol on your product, literature, or packaging reminds you that in the European Union all electrical and electronic products, batteries, and accumulators must be taken to separate collection at the end of their working life. Do not dispose of these products as unsorted municipal waste.

Return the products to collection to prevent possible harm to the environment or human health from uncontrolled waste disposal and to promote the sustainable reuse of material resources. Collection information is available from the product retailer, local waste authorities, national producer responsibility organizations, or your local Nokia representative. For more information, see product Eco-Declaration or country-specific information at [www.nokia.com](http://www.nokia.com).

## Additional safety information

---

### ■ Small children

Your device and its enhancements may contain small parts. Keep them out of the reach of small children.

### ■ Operating environment

This device meets RF exposure guidelines when used either in the normal use position against the ear or when positioned at least 1,5 centimeters (5/8 inches) away from the body. When a carry case, belt clip, or holder is used for body-worn operation, it should not contain metal and should position the device the above-stated distance from your body.

To transmit data files or messages, this device requires a quality connection to the network. In some cases, transmission of data files or messages may be delayed until such a connection is available. Ensure the above separation distance instructions are followed until the transmission is completed.

Parts of the device are magnetic. Metallic materials may be attracted to the device. Do not place credit cards or other magnetic storage media near the device, because information stored on them may be erased.

### ■ Medical devices

Operation of any radio transmitting equipment, including wireless phones, may interfere with the functionality of inadequately protected medical devices. Consult a physician or the manufacturer of the medical device to determine if they are adequately shielded from external RF energy or if you have any questions. Switch off your device in health care facilities when any regulations posted in these areas instruct you to do so. Hospitals or health care facilities may be using equipment that could be sensitive to external RF energy.

### Implanted medical devices

Manufacturers of medical devices recommend that a minimum separation of 15.3 centimeters (6 inches) should be maintained between a wireless device and an implanted medical device, such as a pacemaker or implanted cardioverter defibrillator, to avoid potential interference with the medical device. Persons who have such devices should:

- Always keep the wireless device more than 15.3 centimeters (6 inches) from the medical device when the wireless device is turned on.
- Not carry the wireless device in a breast pocket.
- Hold the wireless device to the ear opposite the medical device to minimize the potential for interference.
- Turn the wireless device off immediately if there is any reason to suspect that interference is taking place.
- Read and follow the directions from the manufacturer of their implanted medical device.

If you have any questions about using your wireless device with an implanted medical device, consult your health care provider.

### Hearing aids

Some digital wireless devices may interfere with some hearing aids. If interference occurs, consult your service provider.

### ■ Vehicles

RF signals may affect improperly installed or inadequately shielded electronic systems in motor vehicles such as electronic fuel injection systems, electronic antiskid (antilock) braking systems, electronic speed control systems, and air bag systems. For more information, check with the manufacturer, or its representative, of your vehicle or any equipment that has been added.

Only qualified personnel should service the device or install the device in a vehicle. Faulty installation or service may be dangerous and may invalidate any warranty that may apply to the device. Check regularly that all wireless device equipment in your vehicle is mounted and operating properly. Do not store or carry flammable liquids, gases, or explosive materials in the same compartment as the device, its parts, or enhancements. For vehicles equipped with an air bag, remember that air bags inflate with great force. Do not place objects, including installed or portable wireless equipment in the area over the air bag or in the air bag deployment area. If in-vehicle wireless equipment is improperly installed and the air bag inflates, serious injury could result.

Using your device while flying in aircraft is prohibited. Switch off your device before boarding an aircraft. The use of wireless teledevices in an aircraft may be dangerous to the operation of the aircraft, disrupt the wireless telephone network, and may be illegal.

### ■ Potentially explosive environments

Switch off your device when in any area with a potentially explosive atmosphere, and obey all signs and instructions. Potentially explosive atmospheres include areas where you would normally be advised to turn off your vehicle engine. Sparks in such areas could cause an explosion or fire resulting in bodily injury or even death. Switch off the device at refueling points such as near

## Additional safety information

gas pumps at service stations. Observe restrictions on the use of radio equipment in fuel depots, storage, and distribution areas; chemical plants; or where blasting operations are in progress. Areas with a potentially explosive atmosphere are often, but not always, clearly marked. They include below deck on boats, chemical transfer or storage facilities, vehicles using liquefied petroleum gas (such as propane or butane), and areas where the air contains chemicals or particles such as grain, dust, or metal powders.

### ■ Emergency calls



**Important:** Wireless phones, including this device, operate using radio signals, wireless networks, landline networks, and user-programmed functions. Because of this, connections in all conditions cannot be guaranteed. You should never rely solely on any wireless device for essential communications like medical emergencies.

To make an emergency call:

1. If the device is not on, switch it on. Check for adequate signal strength.  
Some networks may require that a valid SIM card is properly inserted in the device.
2. Press the end key as many times as needed to clear the display and ready the device for calls.
3. Enter the official emergency number for your present location. Emergency numbers vary by location.
4. Press the call key.

If certain features are in use, you may first need to turn those features off before you can make an emergency call. If the device is in the offline or flight profile mode, you may need to change the profile to activate the phone function before you can make an emergency call. Consult this guide or your service provider for more information.

When making an emergency call, give all the necessary information as accurately as possible. Your wireless device may be the only means of communication at the scene of an accident. Do not end the call until given permission to do so.

### ■ CERTIFICATION INFORMATION (SAR)

**This mobile device meets guidelines for exposure to radio waves.**

Your mobile device is a radio transmitter and receiver. It is designed not to exceed the limits for exposure to radio waves recommended by international guidelines. These guidelines were developed by the independent scientific organization ICNIRP and include safety margins designed to assure the protection of all persons, regardless of age and health.

The exposure guidelines for mobile devices employ a unit of measurement known as the Specific Absorption Rate or SAR. The SAR limit stated in the ICNIRP guidelines is 2.0 watts/kilogram (W/kg) averaged over 10 grams of tissue. Tests for SAR are conducted using standard operating positions with the device transmitting at its highest certified power level in all tested frequency bands. The actual SAR level of an operating device can be below the maximum value because the device is designed to use only the power required to reach the network. That amount changes depending on a number of factors such as how close you are to a network base station. The highest SAR value under the ICNIRP guidelines for use of the device at the ear is 0.65 W/kg.

Use of device accessories and enhancements may result in different SAR values. SAR values may vary depending on national reporting and testing requirements and the network band. Additional SAR information may be provided under product information at [www.nokia.com](http://www.nokia.com).

# Index

---

## Symbols/Numerics

**3-D ringing tones** 64

**802.1x**

security settings 69

## A

**access points** 47

advanced settings 48

creating 67, 68

setting up 47

**activation keys** 73

**Active notes** 41

settings 42

**active standby** 16

**active standby mode**

WLAN wizard 49

**alarm clock** 39

**alert tones** 65

**altitude calibration** 55

**animated screen saver** 18

**antennas** 14

**application manager** 72

**application settings** 71

**applications**

common actions 15

installing 72

modifying installations 73

shortcuts 65

**attachments**

e-mail 30

multimedia messages 29

**audio files** 60

details 60

sending 60

**authority certificates** 76

**autolock period** 66

**automatic answer** 66

## B

**background**

color 18

image 18

**backing up data** 72

**Barcode reader** 75

**barring**

calls 24

net calls 24

password 24

**battery**

charge level 13

charging 10

inserting 8

**blogs** 52

**Bluetooth**

authorizing devices 45

connections 45

display indicators 46

pairing 45

passcode 45

receiving data 45

security 46

sending data 45

**bookmarks**

adding 51

browsing 51

deleting 51

**browsing**

offline 51

web 51

**business cards** 36

deleting 36

saving 36

sending 36

## C

**cable** 44

**cache**

emptying 51

**Calculator** 40

**Calendar** 37

adding received entries 37

changing the view 38

creating entries 37

day view 38

deleting entries 37

month view 38

sending entries 37

settings 38

to-do view 38

week view 38

**call divert settings** 23

**caller ID** 67

**calls**

answering 21

automatic answer 66

barring 24

barring net calls 24

call waiting 67

caller ID 67

conference call 21

data call settings 47, 48, 69

declining 21

diverting 23

diverting to a number 23

fixed dialing 36, 76

making 21

making a call from Log 25

making a net call 23

muting the ringing tone 21

net call alert 67

net calls 22

push to talk 57

rejecting 21

rejecting calls with text message 67

restricting outgoing calls 76

selecting call type 67

settings 67

speed dialing 23

video calls 21

voice commands 59

## Index

- voice dialing 59
- voice mail 24
- camera 61**
  - capturing an image 62
  - light sensitivity 62
  - recording a video clip 62
  - self-timer 62
  - sequence mode 62
  - still image settings 62
  - using the toolbar 62
- capture key 62**
- car kit**
  - remote SIM access 46
- cell broadcast 26, 32**
  - settings 34
- cell broadcast messages 31**
- Certificate manager 76**
- certificates 76**
  - details 76
  - settings 76
- changing the lock code 77**
- channels**
  - push to talk 57
  - radio 64
- charging the battery 10**
- chat**
  - See *IM*
- Clock 39**
  - alarms 39
  - settings 39
  - world clock 39
- conference calls 21**
- configuration messages 70**
- Connection manager 44**
- connection methods**
  - Bluetooth 45
  - cable 44
  - infrared 47
  - modem 44
- connection settings 67**
- connections**
  - data call 47, 48
  - ending 44
  - GPRS settings 48
  - internet 47
  - WLAN settings 50
- connectors 11**
- contact groups 35**
- contacts**
  - adding thumbnails 35
  - changing name order 35
  - copying information 35
  - creating 35
  - default information 35
  - editing 35
  - groups 35
  - ringing tones 35
  - searching 35
  - sending 35
  - SIM card contacts 35
  - SIM directory 36
  - voice tags 35
- converting**
  - currencies 42
  - measurements 42
- currency conversions 42**
- customer service 14**
- D**
- data and software management 72**
- data back-ups 72**
- data call settings 69**
- data synchronization 74**
- date**
  - changing 66
  - settings 66
- day view in Calendar 38**
- deleting**
  - pairing 45
- destination**
  - removing 55
  - setting 55
- device management 72**
- Device manager 72**
- digital certificates 76**
- display**
  - brightness 65
  - changing the look 18
  - contrast 65
  - indicators 13
  - language 66
  - light time-out 65
  - screen saver 65
  - settings 65
  - welcome note 65
- diverting calls 23**
- DTMF tones 24**
- E**
- e-mail**
  - accounts 33
  - automatic retrieval settings 34
  - connecting to mailbox 29
  - creating folders 30
  - deleting 30
  - messages 29
  - replying 30
  - retrieval settings 34
  - setting up 29
  - user settings 33
- EAP**
  - plug-in settings 69
  - using an EAP plug-in 69
- ending**
  - internet connections 51
  - network connections 44
- enhancements**
  - remote SIM access 46
  - settings 66
- equalizer 61**
  - frequency settings 61
- F**
- feeds 52**
- File manager 40**
  - managing files 40



## Index

### files

- audio files 60
- downloading 63
- file rights 73
- flash files 61
- image files 63
- sending 40
- video files 60

### find 40

### fixed dialing 36, 76

### Flash player 61

### frequency settings 61

## G

### Gallery 63

### general settings 65

### general Web settings 52

### Global positioning system

See *GPS*

### GPRS

- access point settings 48
- advanced access point settings 48
- settings 68

### GPS 53

- GPS data 55

## H

### headset

- connecting 10

### hearing

- call information 58
- contacts 58
- current time 58

### help 19

## I

### IM 31

- blocking users 32
- groups 31
- settings 31
- starting a conversation 31

### images 63

- adding to contacts 62, 63
- adjusting 62
- background images 62
- capturing 62
- color effect 62
- folders 63
- organizing 63
- printing 62
- renaming 63
- rotating 63
- sending 63
- settings 62
- timing 62
- wallpaper 63
- white balance 62
- zooming 63

### indicators 13

- alarm 13
- Bluetooth 13
- infrared 13
- missed calls 13

### infrared 47

### inserting

- battery 8
- memory card 9
- SIM card 8

### installation log 72

### installation software package

- settings 73

### installing

- applications 72
- software packages 72

### instant messaging

See *IM*

### internet 51

- access points 47
- browsing 51
- ending connections 51
- settings 47

### internet telephony

See *net calls*

## J

### jad files 72

### jar files 72

### Java applications 72, 73

## K

### key store 77

### keyguard 14

### keypad

- lock settings 66
- locking 14

### keypad tones 65

### keypress time-out 66

### keys 11

- shortcuts 65
- WEP keys 69

## L

### landmarks 56

- categories 56
- creating 56
- editing 56
- receiving 56
- sending 56

### language

- changing 17
- display language 66
- settings 66
- writing language 66

### lights 66

### listening to music 60

### lock code 66

- changing 77

### locking

- device autolock 66
- keypad 14, 66

### locking the device 77

### Log 25

- adding numbers to Contacts 25
- deleting 25
- making a call 25
- sending messages 25
- settings 25

## Index

### logos

- operator logo 65
- welcome logo 65

## M

**MAC address** 68

**mail**

See *e-mail*

**mailboxes**

- connecting 29
- creating 29

**maintenance services** 14

**making a call** 21

**Maps** 53

**measurements**

- converting 42

**measuring system**

- changing 55

**media applications** 60

**media objects** 28

**memory**

- details 18

**memory card** 18

- backing up data 72
- formatting 18
- inserting 9
- locking 77
- microSD 18
- passwords 77
- setting a password 18
- setting password 40
- unlocking 18

**menu** 15

**message reader** 26, 58

**messages** 26

- call rejection messages 67
- cell broadcast messages 31
- cell broadcast settings 34
- configuration messages 70
- e-mail 29
- folders 26
- multimedia messages 27
- other settings 34
- picture messages 27
- service messages 32
- special messages 30
- text message settings 33
- text messages 26
- writing 16

**Messaging** 26

- Drafts folder 26
- folders 26
- Outbox folder 26
- Sent folder 26

**microSD** 18

**MMS**

See *multimedia messages*

**modem** 44

**month view in Calendar** 38

**multimedia messages** 27

- attachments 29
- creating 27
- creating presentations 28

- receiving 28
- replying to 28
- sending 27
- settings 33
- viewing media objects 28

**Music player** 60

- track lists 61

## N

**navigation** 55

**net calls** 22

- alert settings 67
- barring 24
- connecting 23
- making a call 23
- profiles 22, 70
- settings 67, 70

**network**

- selecting mode 67
- settings 67

**news feeds** 52

**Nokia Maps** 53

**Nokia PC Suite** 19

**Nokia support and contact information** 14

**Nokia Team Suite** 40

- editing teams 41

**notes**

- editing 43
- writing 43

## O

**operator**

- logo 65
- selecting 67

**original settings** 67

## P

**packet data**

- access point settings 48
- advanced access point settings 48
- settings 68

**pairing**

- devices 45
- passcode 45

**passcode** 45

**passwords**

- barring password 24
- memory card password 18, 40

**PC Suite** 19

**PDF reader** 42

**personal certificates** 76

**personalization** 17

- background color 18
- background image 18
- changing language 66
- changing themes 18
- display 65
- settings 65
- standby modes 65
- tones 65

**phone**

See *calls*

**picture messages** 27

- viewing 27

## Index

### PIN code

- changing 66
- for security module 77

### playing

- messages 26
- music 60
- video and audio 60
- video clips 62
- voice recordings 58

### predictive text input 17, 66

### presentations

- creating 28
- viewing 28

### printing 43

### profiles 17

- creating 17
- customizing 17
- net call profile 22, 70
- selecting ringing tones 17

### PTT

See *push to talk*

### push messages 32

### push to talk 57

- contacts 57
- creating a channel 57
- exiting 58
- logging in 57
- making a call 57
- settings 57

## Q

### Quickoffice 41

## R

### radio 64

- adjusting volume 64
- saving channels 64
- tuning channels 64

### RealPlayer 60

- playing media clips 60
- sending files 60
- settings 60
- viewing clip details 60

### recorder 58

- playing voice memos 58
- recording a memo 58

### recording

- calls 58
- video clips 62
- voice 58

### remote configuration 72

### remote lock 77

### remote synchronization 74

### repair services 14

### restoring original settings 67

### rights 73

### ringing tones 35

- 3-D 64
- in profiles 17
- ringing type 65
- selecting 65
- vibrating alert 65
- volume 65

## S

### satellite signal strength 55

### saving

- current position 55
- files 15
- settings 15

### screen saver 18, 65

### Search 40

### searching

- available WLANs 44
- contacts 35

### security

- Bluetooth 46
- device and SIM card 66
- Java application 73
- memory card 77
- settings 66

### security module 77

- codes 77
- PIN code 77

### sending

- audio files 60
- contacts 35
- files 15, 40
- images 63
- messages from Log 25
- using Bluetooth 45
- video clips 60
- videos 22

### service commands 30

### service messages 32

### session initiation protocol

See *SIP*

### settings 65

- Active notes 42
- advanced WLAN 68
- applications 71
- Calendar 38
- call divert 23
- calls 67
- cell broadcast 34
- certificate 76
- clock 39
- connection 67
- data call 69
- date 66
- device security 66
- display 65
- e-mail retrieval 34
- e-mail user 33
- EAP plug-ins 69
- enhancements 66
- frequency 61
- general 65
- GPRS 48, 68
- IM 31
- internet 47
- Java application security 73
- keypad lock 66
- language 66
- Log 25
- multimedia messages 33
- net call 70

## Index

- network 67
- packet data 68
- personalization 65
- profiles 17
- push to talk 57
- RealPlayer 60
- restoring 67
- SIP 70
- standby mode 65
- telephone 67
- text messages 33
- time 66
- tones 65
- video clips 63
- voice commands 59
- voice recorder 58
- WEP security 68
- WLAN 68
- WLAN access point 50
- WLAN security 68
- Settings wizard 19**
- sharing videos 22**
- shortcuts 78**
  - applications 65
  - keys 65
- signal strength 13**
- SIM access profile 46**
- SIM card**
  - inserting 8
  - text messages 27
- SIM change lock 66**
- SIM directory 36**
- SIP**
  - creating profiles 67, 70
  - editing profiles 70
  - editing proxy servers 70
  - editing registration servers 70
  - settings 70
- sis files 72**
- SMS**
  - See *text messages*
- software packages**
  - details 72
  - installation settings 73
  - installing 72
  - removing 72
- special messages 30**
- Speech 58**
- speed dialing 23**
- standby modes 16**
  - active standby 16
  - basic standby mode 16
  - settings 65
- support information 14**
- switching device on and off 13**
- Symbian applications 72**
- Sync 74**
- synchronization 74**
  - settings 74
  - synchronization profiles 74
  - synchronizing data with another device 20

## T

- tabs 15**
- taking a picture 62**
- telephone**
  - See *calls*
- telephone settings 67**
- text**
  - letter mode 16
  - number mode 16
  - predictive input 17
  - traditional input 16
  - writing 16
- text messages**
  - messages on SIM card 27
  - sending 26
  - sending options 27
  - settings 33
  - writing 26
- text size**
  - changing 65
- themes 18**
  - changing 18
  - downloading 18
- time**
  - changing 66
  - settings 66
- to-do entries 37**
- to-do view in Calendar 38**
- tones**
  - alert tones 65
  - keypad tones 65
  - settings 65
  - warning tones 65
- track lists 61**
- traditional text input 16**
- Transfer 20**
- transferring data**
  - between devices 20
  - using Bluetooth 20
  - using infrared 20
- trip destination 55**
- trip meter 55**
- tutorial 19**

## U

- UPIN code**
  - changing 66
- USB data cable 44**

## V

- vibrating alert 65**
- video calls 21**
  - making a call 21
  - switching to voice call 21
- video clips 60, 62**
  - details 60
  - playing 60, 62
  - sending 60
  - settings 63
- video sharing 22**
  - receiving invitations 22
- Voice aid 58**

## Index

- voice commands** 59
  - launching an application 59
  - setting on a profile 59
  - settings 59
- voice dialing** 59
- voice mail** 24
  - calling 24
  - changing number 24
- voice memos** 58
- voice over IP**
  - See *net calls*
- voice recorder**
  - settings 58
- volume** 17
  - radio 64

## W

- wallpaper** 63
- WAP**
  - push messages 32
- warning tones** 65
- Web** 51
  - general settings 52
  - page settings 52
  - privacy settings 52
  - web feed settings 52
- web feeds** 52
- week view in Calendar** 38
- Welcome** 15
- welcome note** 65
- WEP**
  - security settings 68
- WEP keys** 69
- Wi-Fi**
  - See *WLAN*
- Wireless keyboard**
  - connecting 43
  - disconnecting 43
- wireless LAN**
  - See *WLAN*
- WLAN** 49
  - 802.1x security settings 69
  - access point settings 50
  - access points 50
  - advanced access point settings 50
  - advanced settings 68
  - availability 49
  - EAP 69
  - MAC address 68
  - searching for networks 44
  - security settings 68
  - settings 68
  - WEP keys 69
  - WPA security settings 69
- WLAN wizard** 49
- world clock** 39
- WPA security settings** 69
- writing language** 17

## Z

- Zip manager** 42