

Nokia C5-03 User Guide

Issue 1.0

Contents**Safety 5**

Battery removing	5
------------------	---

Find help 6

In-device help	6
Accessibility solutions	6
Support	6
Software updates over the air	7
Update device software using your PC	7
Settings	8
Access codes	8
Prolong battery life	8
Increase available memory	9

Get started 10

Insert the SIM card and battery	10
Insert the memory card	12
Remove the memory card	14
Charge the battery	14
Keys and parts	15
Switch the device on	16
Lock the keys and touch screen	17
Home screen	17
Access the menu	18
Touch screen actions	18
Change the ringing tone	20
Ovi by Nokia	20
About Ovi Store	20

Your device 21

Device setup	21
Settings wizard	21
Transfer content for the first time	21
Display indicators	22
Contacts bar	23
Antenna locations	24
Offline profile	24
Shortcuts	25

Volume and loudspeaker control	25
Sensor settings and display rotation	26
Remote lock	26
Headset	26
Attach a wrist strap	27

Make calls 27

Calls	27
During a call	28
Voice mailbox	29
Answer or reject a call	29
Make a conference call	29
Speed dial a phone number	30
Call waiting	30
Voice dialing	31
Log	32

Write text 33

Virtual keyboard	33
Handwriting	34
Enter text with the virtual keypad	35
Touch input settings	37

Contacts 37

Save phone numbers and mail addresses	37
Manage names and numbers	38
Assign default numbers and addresses	38
Ringing tones, images, and call text for contacts	38
Copy contacts	39
SIM services	39

Messaging 40

Messaging main view	40
Write and send messages	41
Messaging inbox	42
Set up your e-mail	44
E-mail service	44
Mailbox	44
Mail for Exchange	46

View messages on a SIM card	47	Web browser	67
Service commands	47	Browse the web	67
Messaging settings	48	Add a bookmark	67
About Ovi Contacts	49	Subscribe to a web feed	67
Connect to the service	50	Discover nearby events	68
Start using Ovi Contacts	50		
Customize your device	51	Positioning (GPS)	68
Change the look of your device	51	About GPS	68
Profiles	52	About assisted GPS (A-GPS)	69
		Hold your device correctly	69
Music folder	52	Tips on creating a GPS connection	70
Music player	52	Position requests	71
Ovi Music	54	Landmarks	71
Nokia Podcasting	55	GPS data	71
Radio	56	Positioning settings	71
Camera	57	Maps	72
Activate the camera	57	Maps overview	72
Image capture	57	View your location and the map	73
Video recording	60	Map view	74
		Change the look of the map	74
Gallery	60	Download and update maps	75
View and organize files	60	About positioning methods	75
View images and videos	61	Find a location	76
Organize images and video	62	View location details	77
		Save or view a place or route	77
Share online	62	Send a place to a friend	78
About Share online	62	Check in	78
Subscribe to an online sharing service	62	Synchronize your Favorites	79
Manage your accounts	62	Get voice guidance	79
Create a post	63	Use the compass	80
Post files from Gallery	63	Drive to your destination	81
		Navigation view	82
Nokia Video Center	63	Get traffic and safety information	82
View and download video clips	64	Walk to your destination	83
Video feeds	65	Plan a route	83
My videos	65		
Transfer videos from your PC	66	Connectivity	85
Video center settings	66	Data connections and access points	85
		Network settings	85
		Wi-Fi/WLAN connection	86
		Access points	89

4 Contents

Close a network connection	91
Synchronization	92
Synchronize data with Ovi Sync	92
Bluetooth connectivity	93
Transfer data using a USB cable	96
PC connections	97
Administrative settings	97

Search 98

About Search	98
Start a search	98

Other applications 99

Clock	99
Calendar	100
File manager	101
Application manager	102
RealPlayer	104
Recorder	105
Write a note	106
Make a calculation	106
Converter	106
Dictionary	106

Settings 107

Phone settings	107
Call settings	112

Protect the environment 114

Save energy	114
Recycle	114

Product and safety information 114

Safety

Read these simple guidelines. Not following them may be dangerous or illegal. Read the complete user guide for further information.

SWITCH OFF IN RESTRICTED AREAS



Switch the device off when cellular phone use is not allowed or when it may cause interference or danger, for example, in aircraft, near medical equipment, fuel, chemicals, or blasting areas.

ROAD SAFETY COMES FIRST



Obey all local laws. Always keep your hands free to operate the vehicle while driving. Your first consideration while driving should be road safety.

INTERFERENCE



All wireless devices may be susceptible to interference, which could affect performance.

QUALIFIED SERVICE



Only qualified personnel may install or repair this product.

KEEP YOUR DEVICE DRY



Your device is not water-resistant. Keep it dry.

PROTECT YOUR HEARING



Listen to a headset at a moderate level, and do not hold the device near your ear when the loudspeaker is in use.

Battery removing

Switch the device off and disconnect the charger before removing the battery.

Find help

In-device help

Your device contains instructions to help to use the applications in your device.

To open help texts from the main menu, select **Menu > Applications > Help** and the application for which you want to read instructions.

When an application is open, to access the help text for the current view, select **Options > Help**.

When you are reading the instructions, to change the size of the help text, select **Options > Decrease font size** or **Increase font size**.

You may find links to related topics at the end of the help text.

If you select an underlined word, a short explanation is displayed.

Help texts use the following indicators:



Link to a related help topic.



Link to the application being discussed.

When you are reading the instructions, to switch between help texts and the application that is open in the background, select **Options > Show open apps**, and the desired application.

Accessibility solutions

Nokia is committed to making mobile phones easy to use for all individuals, including those with disabilities. For more information, visit the Nokia website at www.nokiaaccessibility.com.

Support

When you want to learn more about how to use your product or you are unsure how your device should function, go to www.nokia.com/support, or using a cellular phone, www.nokia.mobi/support. You can also select **Menu > Applications > Help** in your device.

If this does not resolve your issue, do one of the following:

- Reboot your device. Switch off the device, and remove the battery. After about a minute, replace the battery, and switch on the device.
- Restore the original factory settings.
- Update your device software.

If your issue remains unsolved, contact Nokia for repair options. Go to www.nokia.com/repair, or in Latin America, www.nokia-latinoamerica.com/centrosdeservicio. Before sending your device for repair, always back up the data in your device.

Software updates over the air

Select **Menu > Applications > Tools > SW update**.

With Software update (network service), you can check if there are updates available for your device software or applications, and download them to your device.



Warning:

If you install a software update, you cannot use the device, even to make emergency calls, until the installation is completed and the device is restarted.

After updating your device software or applications using Software update, the instructions related to the updated applications in the user guide or the helps may no longer be up to date.

To download the available updates, select . To unmark specific updates that you do not want to download, select the updates from the list.

To view information on an update, select the update and .

To view the status of previous updates, select .

Select **Options** and from the following:

Update via PC — Update your device using a PC. This option replaces the Start update option when updates are only available using the Nokia Software Updater PC application.

View update history — View the status of previous updates.

Settings — Modify the settings, such as the default access point used for downloading updates.

Disclaimer — View the Nokia license agreement.

Update device software using your PC

You can use the Nokia Ovi Suite PC application to update your device software. You need a compatible PC, a high-speed internet connection, and a compatible USB data cable to connect your device to the PC.

To get more information and to download the Nokia Ovi Suite application, go to www.ovi.com/suite.

Settings

Your device normally has MMS, GPRS, streaming, and mobile internet settings automatically configured in the device, based on your network service provider information. You may have settings from your service providers already installed in your device, or you may receive or request the settings from the network service providers as a special message.

Access codes

PIN code — Protect your device and SIM card against unauthorized use. The PIN code (4 - 8 digits) is usually supplied with the SIM card.

PIN2 code — This code (4 - 8 digits) is supplied with some SIM cards, and is required to access some functions in your device.

If you forget an access code, contact the network service provider whose SIM card is in your device. After three consecutive incorrect PIN or PIN2 code entries, the code is blocked, and you need the PUK or PUK2 code to unblock it.

PUK code and PUK2 code — These codes (8 digits) are required to change a blocked PIN code or PIN2 code, respectively. If the codes are not supplied with the SIM card, contact the network service provider whose SIM card is in your device.

IMEI number — This number (15 digits) is used to identify valid devices in the GSM network. Devices that are, for example, stolen, can be blocked from accessing the network. The IMEI number for your device can be found under the battery.

Lock code (also known as security code) — The lock code helps you to protect your device against unauthorized use. You can create and change the code, and set the device to request the code. Keep the new code secret and in a safe place separate from your device. If you forget the code and your device is locked, your device will require service and additional charges may apply. Additional charges may apply, and all the personal data in your device may be deleted. For more information, contact a Nokia Care Point or your device dealer.

Prolong battery life

Many features in your device increase the demand on battery power and reduce the battery lifetime. To save battery power, note the following:

- Features that use Bluetooth connectivity, or allowing such features to run in the background while using other features, increase the demand on battery power. Deactivate Bluetooth connectivity when you do not need it.
- Features that use Wi-Fi, or allowing such features to run in the background while using other features, increase the demand on battery power. Wi-Fi connectivity is deactivated when you are not trying to connect, not connected to an access point, or not scanning for available networks. To further reduce battery consumption, you

can specify that your device does not scan, or scans less often, for available networks in the background.

- If you have selected **Packet data connection > When available** in the connection settings, and there is no packet data coverage (GPRS), the device periodically tries to establish a packet data connection. To prolong the operating time of your device, select **Packet data connection > When needed**.
- The Maps application downloads new map information when you move to new areas on the map, which increases the demand on battery power. You can prevent the automatic download of new maps.
- If the signal strength of the cellular network varies much in your area, your device must scan for the available network repeatedly. This increases the demand on battery power.

If the network mode is set to dual mode in the network settings, the device searches for the 3G network. To set the device to use only the GSM network, select **Menu > Settings and Connectivity > Network > Network mode > GSM**.

- The backlight of the display increases the demand on battery power. In the display settings, you can adjust the display brightness and change the time-out period after which the backlight is switched off. Select **Menu > Settings and Phone > Display > Brightness or Light time-out**.
- Leaving applications running in the background increases the demand on battery power. To access the applications you are not using, press and hold the menu key, and select an application.

Increase available memory

Do you need more available device memory for new applications and content?

View how much space is available for different data types

Select **Menu > Applications > Office > File mgr..**

Many features of the device use memory to store data. The device notifies you if the memory in different memory locations is low.

Increase available memory

Transfer data to a compatible memory card (if available) or to a compatible computer.

To remove data you no longer need, use File manager or open the respective application. You can remove the following:

- Messages in the folders in Messaging and retrieved e-mail messages in the mailbox
- Saved web pages
- Contact information

10 Get started

- Calendar notes
- Applications shown in Application manager that you do not need
- Installation files (.sis or .sisx) of applications you have installed. Transfer the installation files to a compatible computer.
- Images and video clips in Gallery. Back up the files to a compatible computer.

Get started

Insert the SIM card and battery

Safe removal. Always switch the device off and disconnect the charger before removing the battery.

 **Important:** Do not use a mini-UICC SIM card, also known as a micro-SIM card, a micro-SIM card with an adapter, or a SIM card that has a mini-UICC cutout (see figure) in this device. A micro-SIM card is smaller than the standard SIM card. This device does not support the use of micro-SIM cards and use of incompatible SIM cards may damage the card or the device, and may corrupt data stored on the card.



A SIM card may be already inserted in the device. If not, do the following:

- 1 Remove the back cover.

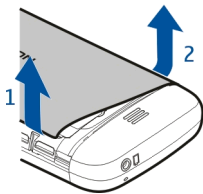

- 2 Remove the battery, if inserted.

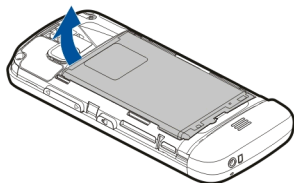

- 3 Slide the SIM card holder, to unlock it.

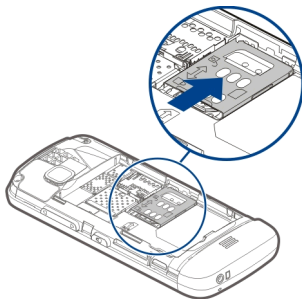

- 4 Lift the SIM card holder up.



- 5 Make sure the contact area of the SIM card is facing toward the device, and slide the SIM card into the SIM card holder.

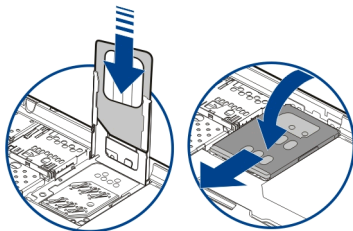

- 6 Lower the SIM card holder into place. Slide the SIM card holder, to lock it.
- 7 Line up the battery contacts, and insert the battery.

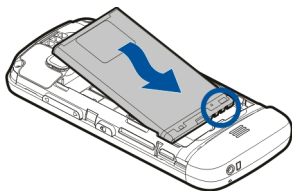

- 8 To replace the cover, direct the top locking catches toward their slots, and press down until the cover locks into place.

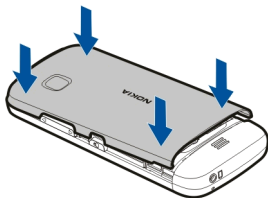

If the SIM card is not properly in place, the device can only be used in the offline profile.

Insert the memory card

Use only compatible memory cards approved by Nokia for use with this device. Incompatible cards may damage the card and the device and corrupt data stored on the card.



- 1 Remove the back cover.

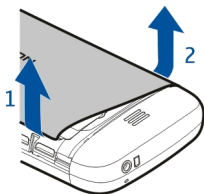

- 2 Make sure the contact area of a compatible memory card is facing down, and insert it into the memory card slot.

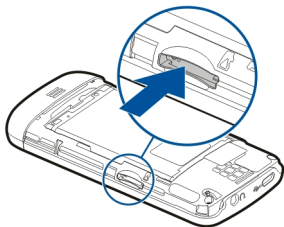

- 3 Push the card in, until you hear a click.

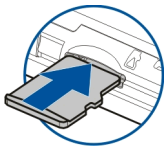

- 4 Replace the back cover.

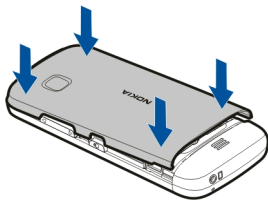

Remove the memory card

 **Important:** Do not remove the memory card when an application is using it. Doing so may damage the memory card and the device, and corrupt data stored on the card.

- 1 If the device is switched on, before you remove the card, press the power key, and select **Remove memory card**.
- 2 When **Remove memory card? Some applications will be closed.** is displayed, select **Yes**.
- 3 When **Remove memory card and press 'OK'** is displayed, remove the back cover of the device, and push the card in, until you hear a click.
- 4 Pull out the memory card, and replace the back cover. If the device is switched on, select **OK**.

Charge the battery

Your battery has been partially charged at the factory, but you may need to recharge it before you can switch on your device for the first time. If the device indicates a low charge, do the following:

- 1 Connect the charger to a wall outlet.
- 2 Connect the charger to the device.

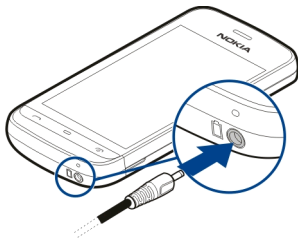

- 3 When the device indicates a full charge, disconnect the charger from the device, then from the wall outlet.

You do not need to charge the battery for a specific length of time, and you can use the device while it is charging. If the battery is completely discharged, it may take several minutes before the charging indicator appears on the display or before any calls can be made.

Tip: Disconnect the charger from the wall outlet when the charger is not in use. A charger that is connected to the outlet consumes power even when it is not connected to the device.

USB charging

You can use USB charging when a wall outlet is not available. Data can be transferred while charging the device. The efficiency of USB charging power varies significantly, and it may take a long time for charging to start and the device to start functioning.

- 1 Use a compatible USB data cable to connect your device to a compatible USB device. Depending on the type of the device that is used for charging, it may take a while for charging to start.
- 2 If the device is switched on, select the appropriate USB mode.

Keys and parts

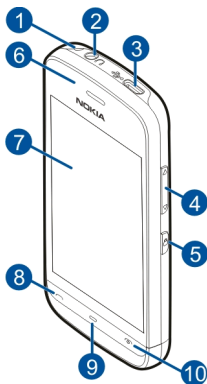

- 1 Wrist strap hole
- 2 Nokia AV connector (3.5 mm)
- 3 Micro USB connector
- 4 Volume/Zoom key

16 Get started

- 5 Lock key
- 6 Earpiece
- 7 Touch screen
- 8 Call key
- 9 Menu key
- 10 End/power key
- 11 Camera lens
- 12 Loudspeaker
- 13 Charger connector
- 14 Microphone

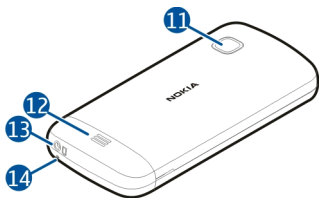

Switch the device on

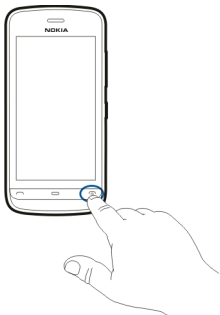

- 1 Press and hold the power key.
- 2 If the device asks for a PIN code or lock code, enter it, and select **OK**. To delete a number, select **X**. The factory setting for the lock code is **12345**.
- 3 Select your location. If you accidentally select the wrong location, select **Back**.
- 4 Enter the date and time. When using the 12-hour time format, to switch between a.m. and p.m., select any number.

Lock the keys and touch screen

To lock the touch screen and the keys, press the lock key on the side of the device.

To unlock, press the lock key on the side of the device, and select the unlock icon on the screen.

When the touch screen and keys are locked, the touch screen is switched off and the keys are inactive.

The screen and keys may be locked automatically after a period of inactivity.

To change the settings for automatic screen and key locking, select **Menu > Settings and Phone > Phone mgmt. > Auto. keyguard > Keypad autolock period.**

Home screen

The home screen is your starting point where you can collect all your important contacts or application shortcuts.

Interactive display elements

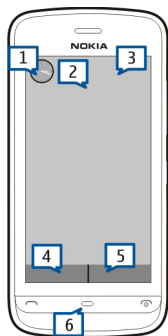

To open the clock application, tap the clock (1).

To open calendar or change profiles in the home screen, tap the date or the profile name (2).

18 Get started

To view or change connectivity settings () to see the available Wi-Fi networks if Wi-Fi scanning is enabled, or to view missed events, tap the top right corner (3).

To make a phone call, select  (4), or, if the contacts bar is active, select **Telephone**.

To open Contacts, select  (5), or, if the contacts bar is active, select **Contacts**.

To open the main menu, press the menu key (6).

Start using the contacts bar

To add a contact to the contacts bar, in the home screen, select  and a contact, and follow the displayed instructions.

Contacts need to be saved in the phone memory.

To add a new contact to your contacts list, select  > **Options** > **New contact**, and follow the displayed instructions.

Contacts added from the contacts bar are always saved to the phone memory.

Change the home screen theme

To change the home screen theme or the shortcuts, select **Menu** > **Settings and Personal** > **Home screen**.

Access the menu

To access the menu, press the menu key.

To open an application or folder in the menu, select the item.

Touch screen actions

Open an application or other screen element

Tap the application or element once.

To view the options available for the opened item, select **Options** or, if available, select an icon from a toolbar.

Access functions quickly

Tap and hold the item. A pop-up menu with available options opens. For example, to send an image, tap and hold the image, and from the pop-up menu, select the appropriate option.

Tip: To see the options available for an opened item, such as an image or a video, tap the screen.

Select

In this user documentation, opening applications or items by tapping them is called "selecting". If you need to select several items in a sequence, the menu items to select are separated by arrows.

For example, to select **Options** > **Help**, tap **Options**, and then tap **Help**.

Drag an item

Tap and hold the item, and slide your finger across the screen. The item follows your finger.

To scroll up or down on a web page, drag the page with your finger.

Swipe

Place a finger on the screen, and steadily slide your finger in the desired direction.

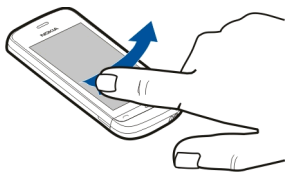

When viewing an image, to view the next or previous image, swipe the image left or right, respectively.

Scroll

To scroll up or down in lists that have a scroll bar, drag the slider of the scroll bar.

Place your finger on the screen, slide it quickly up or down the screen, then lift your finger. The content of the screen scrolls with the speed and direction it had at the moment of release. To select an item from a scrolling list and to stop the movement, tap the item.

Tip: To view a brief description of an icon, place your finger on the icon. Descriptions are not available for all icons.

Touch screen backlight

The touch screen backlight is turned off after a period of inactivity. To turn the screen backlight on, tap the screen.

If the touch screen and keys are locked, tapping the screen does not turn the screen backlight on.

Change the ringing tone

Select **Menu > Settings and Personal > Profiles**.

You can use profiles to set and customize the ringing tones, message alert tones, and other tones for different events, environments, or caller groups.

To customize a profile, go to the profile, and select **Personalise**.

Ovi by Nokia

 With Ovi by Nokia, you can find new places and services, and stay in touch with your friends. You can do, for example, the following:

- Download games, applications, videos, and ringing tones to your device
- Find your way with free walk and drive navigation, plan trips, and view locations on a map
- Get a free Ovi Mail account
- Buy music

Some items are free of charge, others you may need to pay for.

The available services may also vary by country or region, and not all languages are supported.

To access Nokia's Ovi services, go to www.ovi.com, and register your own Nokia account.

For more help and information, go to www.ovi.com.

About Ovi Store

 With Ovi Store, you can download mobile games, applications, videos, pictures, themes, and ringing tones to your device. Some items are free of charge; others you need to pay for with your credit card or in your phone bill. The availability of payment methods depends on your country of residence and your network service provider. Ovi Store offers content that is compatible with your mobile device and relevant to your tastes and location.

Your device

Device setup

 With the Phone setup application, you can do the following, for example:

- Define the regional settings, such as the language of the device.
- Transfer data from your old device.
- Customize your device.
- Set up your mail accounts.
- Activate Ovi services.

When you switch on your device for the first time, the Phone Setup application opens. To open the application later, select **Menu > Applications > Tools > Phone setup**.

Settings wizard

With Settings wizard, you can define e-mail and connection settings. The availability of the items in Settings wizard depends on the features of the device, SIM card, service provider, and the data in the Settings wizard database.

Select **Menu > Applications > Tools > Sett. wizard**.

To get the best results when using Settings wizard, keep your SIM card inserted in the device. If the SIM card is not inserted, follow the instructions on the display.

Select from the following:

Operator — Define the operator-specific settings, such as MMS, internet, WAP, and streaming settings.

E-mail setup — Set up a POP, IMAP, or Mail for Exchange account.

The settings available for editing may vary.

Transfer content for the first time





- 1 Select **Menu > Applications > Tools > Switch**.
- 2 Select the connection type you want to use to transfer the data, and connect the devices. Both devices must support the selected connection type.
If you select Bluetooth connectivity as the connection type, you may need to pair the devices.
- 3 On your device, select the content you want to transfer from the other device.

When the transfer has started, you can cancel it and continue later.



Content is transferred from the memory of the other device to the corresponding location in your device. The transfer time depends on the amount of data to be transferred.

Display indicators



General indicators

	The touch screen and keys are locked.
	The device alerts silently for incoming calls or messages.
	You have set a clock alarm.
	You are using a timed profile.

Call indicators















	Someone has tried to call you.
	You have set your device to forward incoming calls to another number (network service).
	Your device is ready for an internet call.

Messaging indicators







	You have unread messages. If the indicator is blinking, the SIM card memory for messages may be full.
	You have received new mail.
	You have messages waiting to be sent in the Outbox folder.

Network indicators

	Your device is connected to a GSM network (network service).
3G	Your device is connected to a 3G network (network service).
3.5G	High-speed downlink packet access (HSDPA) / high-speed uplink packet access (HSUPA) (network service) in the 3G network is activated.

	You have a GPRS packet data connection (network service).  indicates that the connection is on hold and  that a connection is being established.
	You have an EGPRS packet data connection (network service).  indicates that the connection is on hold and  that a connection is being established.
	You have a 3G packet data connection (network service).  indicates that the connection is suspended and  that a connection is being established.
	You have a high-speed downlink packet access (HSDPA) connection (network service).  indicates that the connection is suspended and  that a connection is being established.
	A Wi-Fi connection is available (network service).  indicates that the connection is encrypted and  that the connection is not encrypted.

Connectivity indicators

	Bluetooth is active.  indicates that your device is sending data. If the indicator is blinking, your device is trying to connect to another device.
	You have connected a USB cable to your device.
	GPS is active.
	The device is synchronizing.
	You have connected a compatible headset to the device.



Contacts bar

To add a contact to the home screen, in the home screen, select  > **Options** > **New contact**, and follow the instructions.

To communicate with a contact, select the contact and from the following:

 — Call the contact.

 — Send a message to the contact.

 — Add a link to an Ovi contact. If you want to chat to an Ovi contact, select the contact. The icon changes to . To start chatting, select the icon.

 — Refresh the contact's web feeds.

To view past communication events with a contact, select the contact. To view the details of a communication event, select the event.

To close the view, select **Options** > **Exit**.

Antenna locations

Avoid touching the antenna area unnecessarily while the antenna is transmitting or receiving. Contact with antennas affects the communication quality and may cause a higher power level during operation and may reduce the battery life.

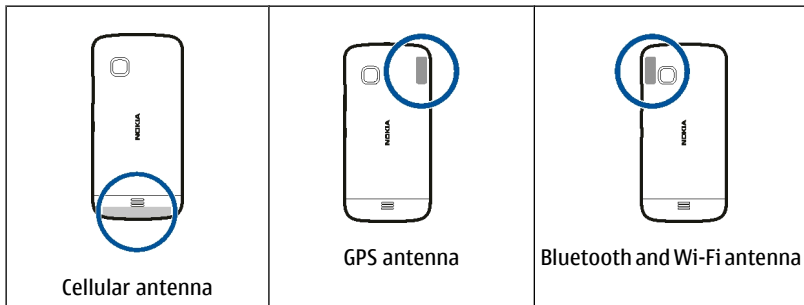

Offline profile

The offline profile lets you use the device without connecting to the wireless cellular network. When the offline profile is active, you can use your device without a SIM card.

Activate the offline profile

Press the power key briefly, and select **Offline**.

When you activate the offline profile, the connection to the cellular network is closed. All radio frequency signals to and from the device to the cellular network are prevented. If you try to send messages using the cellular network, they are placed in the Outbox folder to be sent later.

 **Important:** In the offline profile you cannot make or receive any calls, or use other features that require cellular network coverage. You may be able to call the official

emergency number programmed into your device. To make calls, you must first change to another profile.

When you have activated the offline profile, you can still use a wireless LAN (WLAN), for example, to read your e-mail or browse on the internet. You can also use Bluetooth connectivity while in the offline profile. Remember to comply with any applicable safety requirements when establishing and using WLAN or Bluetooth connections.

Shortcuts

To switch between open applications, press and hold the menu key.

Leaving applications running in the background increases the demand on battery power and reduces the battery life.

To change the profile, press the power key, and select a profile.

To call your voice mailbox (network service), in the dialer, tap and hold **1**.

To open a list of last dialed numbers, in the home screen, press the call key.

To use voice commands, in the home screen, press and hold the call key.

Volume and loudspeaker control

Adjust the volume of a phone call or sound clip

Use the volume keys.



The built-in loudspeaker allows you to speak and listen from a short distance without having to hold the device to your ear.

Use the loudspeaker during a call

Select **Activate loudsp..**

Turn off the loudspeaker.

Select **Activate handset**.

Sensor settings and display rotation

When you activate the sensors in your device, you can control certain functions by turning the device.

Select **Menu > Settings and Phone > Sensor settings**.

Select from the following:

Sensors — Activate the sensors.

Turning control — Select **Silencing calls** and **Snoozing alarms** to mute calls and snooze alarms by turning your device so that the display faces down. Select **Auto-rotate display** to rotate the display content automatically when you turn the device on its left side or back to a vertical position. Some applications and features may not support rotating the display content.

Remote lock

You can lock your device remotely using a predefined text message. You can also lock the memory card remotely.

Enable remote locking

- 1 Select **Menu > Settings and Phone > Phone mgmt. > Security > Phone and SIM card > Remote phone locking > Enabled**.
- 2 Enter the text message content (5-20 characters), verify it, and enter the lock code.

Lock your device remotely

Write the predefined text message, and send it to your device. To unlock your device, you need the lock code.

Headset

You can connect a compatible headset or compatible headphones to your device. You may need to select the cable mode.

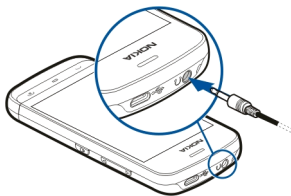

Attach a wrist strap

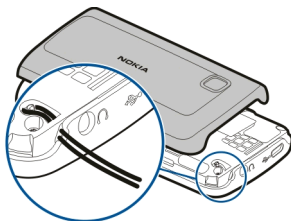

Make calls

Calls

- 1 In the home screen, select **Telephone** to open the dialer, and enter the phone number, including the area code. To remove a number, select . For international calls, select * twice for the + character (which replaces the international access code), and enter the country code, area code (omit the leading zero if necessary), and phone number. The + character as a replacement for the international access code may not work in all regions. In this case, enter the international access code directly.
- 2 To make the call, press the call key.
- 3 To end the call (or to cancel the call attempt), press the end key. Pressing the end key always ends a call, even if another application is active.

To make a call from the contacts list, select **Menu > Contacts**.

Go to the desired name. Or, select the search field, enter the first letters or characters of the name, and go to the name.

To call the contact, press the call key. If you have saved several numbers for a contact, select the desired number from the list, and press the call key.

During a call

To use the following options, first press the lock key to unlock the device.

Mute or unmute the microphone

Select  or .

Put an active voice call on hold

Select  or .

Activate the loudspeaker

Select . If you have attached a compatible headset with Bluetooth connectivity, to route the sound to the headset, select **Options** > **Activate BT handsfree**.

Switch back to the handset

Select .

End a call

Select .

Switch between active and held calls

Select **Options** > **Swap**.

Tip: To put an active call on hold, press the call key. To activate the held call, press the call key again.

Send Touch tone strings

- 1 Select **Options** > **Send DTMF**.
- 2 Enter the Touch tone string or search for it from the contacts list.
- 3 To enter a wait character (w) or a pause character (p), press * repeatedly.
- 4 To send the tone, select the tone. You can add Touch tones to the phone number or Touch field in contact details.

End an active call and replace it with another incoming call

Select **Options** > **Replace**.

End all calls

Select **Options** > **End all calls**.

Many of the options that you can use during a voice call are network services.

Voice mailbox

To call your voice mailbox (network service), in the home screen, select **Telephone**, and select and hold **1**.

- 1 To change the phone number of your voice mailbox, select **Menu > Settings and Calling > Call mailbox**, and a mailbox. Select and hold the current number.
- 2 Enter the number (obtained from your network service provider), and select **OK**.

Answer or reject a call

Answer a call

Press the call key.

Mute the ringing tone of an incoming call

Select .

Send a reject call text message

Select **Send msg.**, edit the message text, and press the call key. With the reply message you can inform the caller that you cannot answer the call.

Reject a call

Press the end key. If you activate the **Call divert > Voice calls > If busy** function in phone settings, rejecting an incoming call also diverts the call.

Activate the reject call text message feature

Select **Menu > Settings and Calling > Call > Reject call with message > Yes**.

Write a standard reject call text message

Select **Menu > Settings and Calling > Call > Message text**, and write the message.

Make a conference call

Your device supports conference calls between a maximum of six participants, including yourself.

- 1 Make a call to the first participant.
- 2 To make a call to another participant, select **Options > New call**. The first call is put on hold.
- 3 When the new call is answered, to add the first participant to the conference call, select .

Add a new participant to a conference call

Make a call to another participant, and add the new call to the conference call.

Have a private conversation with a conference call participant

Select .

Go to the participant, and select . The conference call is put on hold on your device. The other participants can still continue the conference call.

To return to the conference call, select .

Drop a participant from a conference call

Select , go to the participant, and select .

End an active conference call

Press the end key.

Speed dial a phone number

To activate 1-touch dialing, select **Menu > Settings and Calling > Call > Speed dialling**.

- 1 To assign a phone number to one of the number keys, select **Menu > Settings and Calling > Speed dialling**.
- 2 Select and hold the key to which you want to assign the phone number, and from the pop-up menu, select **Assign** and the desired phone number from the contacts list.
1 is reserved for the voice mailbox.

To call in the home screen, select **Telephone** and the assigned key, and press the call key.

To call in the home screen when speed dialling is active, select **Telephone**, and select and hold the assigned key.

Call waiting

With call waiting (network service), you can answer a call when you have another call in progress.

Activate call waiting

Select **Menu > Settings and Calling > Call > Call waiting**.

Answer a waiting call

Press the call key. The first call is put on hold.

Swap between an active call and a call on hold

Select **Options** > **Swap**.

Connect the call on hold to the active call

Select **Options** > **Transfer**. You disconnect yourself from the calls.

End an active call

Press the end key.

End both calls

Select **Options** > **End all calls**.

Voice dialing

Your device automatically creates a voice tag for the contacts.

Listen to a voice tag for a contact

- 1 Select a contact and **Options** > **Voice tag details**.
- 2 Scroll to a contact detail, and select **Options** > **Play voice tag**.

Make a call with a voice tag



Note: Using voice tags may be difficult in a noisy environment or during an emergency, so you should not rely solely upon voice dialing in all circumstances.

When you use voice dialing, the loudspeaker is in use. Hold the device at a short distance away when you say the voice tag.

- 1 To start voice dialing, in the home screen, press and hold the call key. If a compatible headset with the headset key is attached, press and hold the headset key to start voice dialing.
- 2 A short tone sounds, and **Speak now** is displayed. Say clearly the name that is saved for the contact.
- 3 The device plays a synthesized voice tag for the recognized contact in the selected device language, and displays the name and number. To cancel the voice dialing, select **Quit**.

If several numbers are saved for a name, you can say also the name and the number type, such as mobile or telephone.

Log

The Log application stores information about the communication history of the device. The device registers missed and received calls only if the network supports these functions, and the device is switched on and within the network service area.

Recent calls

You can view information about your recent calls.

Select **Menu** > **Applications** > **Log and Recent calls**.

View missed, received, and dialed calls

Select **Missed calls**, **Received calls**, or **Dialed numbers**.

Tip: To open the dialed numbers list in the home screen, press the call key.

Select **Options** and from the following:

Save to Contacts — Save a phone number from a recent calls list to your contacts.

Clear list — Clear the selected recent calls list.

Settings — Select **Log duration** and the length of time that the communication information is saved in the log. If you select **No log**, no information is saved in the log.

Packet data

Select **Menu** > **Applications** > **Log**.

You may be charged for your packet data connections by the amount of data sent and received.

Check the amount of data sent or received during GPRS connections

Select **Data counter** > **All sent data** or **All received data**.

Clear both sent and received information

Select **Data counter** > **Options** > **Clear counters**. You need the lock code to clear the information.

Call duration

You can view the approximate duration of your last call, dialed and received calls, and all calls.



Select **Menu** > **Applications** > **Log and Call duration**.

Monitor all communication events

In the general log, you can view information on communication events, such as voice calls, text messages, or data and Wi-Fi connections registered by your device.

Select **Menu** > **Applications** > **Log**.

Open the general log

Open the general log tab   .

Subevents, such as a text message sent in more than one part and packet data connections, are logged as one communication event. Connections to your mailbox, multimedia messaging center, or web pages are shown as packet data connections.

View the packet data connection details

Go to an incoming or outgoing packet data connection event indicated with **GPRS**, and select the connection event.

Copy a phone number from the log

Select and hold the number, and from the pop-up menu, select **Use number** > **Copy**. You can, for example, paste the phone number to a text message.

Filter the log

Select **Options** > **Filter** and a filter.

Define the log duration

Select **Options** > **Settings** > **Log duration**. If you select **No log**, all the log contents, recent calls register, and messaging delivery reports are permanently deleted.

Write text

The on-screen keyboards allow you to enter characters by tapping them with your fingers.

Tap any text input field to enter letters, numbers, and special characters.

Your device can complete words based on the built-in dictionary for the selected text input language. The device also learns new words from your input.

Virtual keyboard

You can use the virtual keyboard in landscape mode.

To activate the virtual keyboard, select  > **Full screen QWERTY**.

When using the virtual keyboard in full screen mode, you can select keys with your fingers.

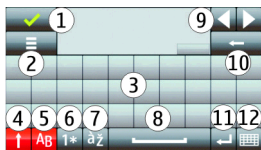

- 1 Close - Close the virtual keyboard.
- 2 Input menu - Open the touch input options menu to access commands such as **Writing language**.
- 3 Virtual keyboard
- 4 Shift and caps lock - To enter an uppercase character when writing in lowercase, or vice versa, select the key before entering the character. To activate the caps lock, select the key twice. A line under the key indicates that the caps lock is activated.
- 5 Letters
- 6 Numbers and special characters
- 7 Character accents
- 8 Space bar
- 9 Move - Move the cursor.
- 10 Backspace
- 11 Enter - Move the cursor to the next row or text input field. Additional functions are based on the current context (for example, in the web address field of the web browser, it acts as the Go button).
- 12 Input mode - Select the input method. When you tap an item, the current input method view closes, and the selected one opens.

Handwriting

The input methods and languages supported by the handwriting recognition vary by region and may not be available for all languages.

To activate handwriting mode, select  > **Handwriting**.

Write legible, upright characters on the text input area, and leave a space between each character.

To teach the device your handwriting style, select  > **Handwriting training**.

To enter letters and numbers (default mode), write words as you would normally. To select number mode, select . To enter non-Latin characters, select the corresponding icon, if available.

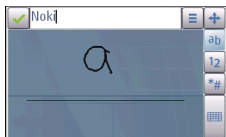

To enter special characters, write them as you would normally, or select ***#** and the desired character.

To delete characters or move the cursor back, swipe backwards (see Figure 1).

To insert a space, swipe forwards (see Figure 2).



Enter text with the virtual keypad

Virtual keypad

With the virtual keypad (**Alphanumeric keypad**), you can enter characters like you would with a traditional physical keypad with numbers on the keys.

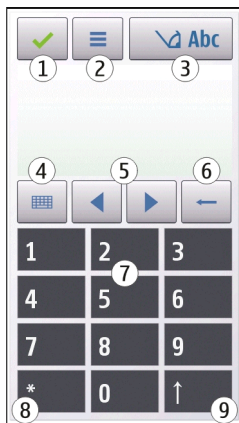

- 1 Close - Closes the virtual keypad (**Alphanumeric keypad**).
- 2 Input menu - Opens the touch input menu, which includes commands such as **Activate predictive text** and **Writing language**.
- 3 Text input indicator - Opens a pop-up window, in which you can activate or deactivate predictive text input modes, change the character case, and switch between letter and number modes.
- 4 Input mode - Opens a pop-up window, in which you can select the input mode. When you tap an item, the current input method view closes, and the selected one opens. The availability of input modes may vary depending on whether the automatic input mode (sensor settings) is activated or not.
- 5 Arrow keys - Scroll left or right.
- 6 Backspace
- 7 Numbers
- 8 Star - Opens a special characters table.
- 9 Shift - Changes the character case, activates or deactivates predictive text input modes, and switches between letter and number modes.

Traditional text input

Tap a number key (1-9) repeatedly until the desired character appears. There are more characters available for a number key than are visible on the key.

If the next letter is located on the same key as the present one, wait until the cursor appears (or move the cursor forward to end the time-out period), and enter the letter.

To insert a space, tap **0**. To move the cursor to the next line, tap **0** three times.

Predictive text input

With predictive text input, to enter a word, select one number key for each letter in the word. Predictive text input is based on a built-in dictionary to which you can add new words. Predictive text input is not available for all languages.

- 1 To activate predictive text input for all editors on the device, select  > **Activate prediction**.
- 2 Write a word. For example, to write "Nokia" when the English dictionary is selected, select **6** for N, **6** for o, **5** for k, **4** for i, and **2** for a.
The word suggestion changes after each key selection.
- 3 If the word is not correct, select ***** repeatedly, until the correct match is displayed. If the word is not in the dictionary, select **Spell**, enter the word using traditional text input mode, and select **OK**.

If **?** is displayed after the word, the word is not in the dictionary. To add a word to the dictionary, select *****, enter the word using traditional text input mode, and select **OK**.

- 4 To insert a punctuation mark, select *****.
- 5 To insert a space, select **0**.

Touch input settings

Select **Menu > Settings and Phone > Touch input**.

To modify text input settings for the touch screen, select from the following:

Handwriting training — Open the handwriting training application. Train the device to recognize your handwriting better. This option is not available in all languages.

Writing language — Define which language-specific characters in your handwriting are recognised and how the virtual keyboard is laid out.

Writing speed — Select the writing speed.

Guiding line — Display or hide the guiding line in the writing area. The guiding line helps you write in a straight line, and it also helps the device recognize your writing.

Pen trail width — Select the pen trail width for the text written with the stylus.

Writing colour — Select the color of the text written with the stylus.

Adaptive search — Activate adaptive search.

Touch screen calibration — Calibrate the touch screen.

Contacts

You can save and update contact information, such as phone numbers, home addresses, or e-mail addresses of your contacts. You can add a personal ringing tone or a thumbnail image to a contact. You can also create contact groups, which allow you to send text messages or e-mail to many recipients at the same time.

To open the contacts list, in the home screen, depending on the home screen theme, select **Contacts** or .

Save phone numbers and mail addresses

You can save your friends' phone numbers, mail addresses, and other information to your contacts list.

Select **Menu > Contacts**.

Add a contact to the contacts list

- 1 Select **Options > New contact**.
- 2 Select a field, and enter the details. To close the text input, select .

Edit contact information

Select a contact and **Options** > **Edit**.

Add details about a contact

Select a contact and **Options** > **Edit** > **Options** > **Add detail**.

Manage names and numbers

To send a contact as a business card to another device, select and hold the contact, and from the pop-up menu, select **Send as business card**.

To delete contacts, select **Options** > **Mark/Unmark** to mark the desired contacts, and to delete, select **Options** > **Delete**.

To listen to the voice tag assigned to a contact, select the contact and **Options** > **Voice tag details** > **Options** > **Play voice tag**.

When entering contacts or editing voice commands, do not use very short or similar names for different contacts or commands.

 **Note:** Using voice tags may be difficult in a noisy environment or during an emergency, so you should not rely solely upon voice dialing in all circumstances.

Assign default numbers and addresses

If a contact has several numbers or addresses, a default number or address makes it easier for you to call or send a message to the contact. The default number is also used in voice dialing.

- 1 Select **Menu** > **Contacts**.
- 2 Select a contact and **Options** > **Defaults**.
- 3 Select a default to which you want to add a number or an address.
- 4 Select a number or an address you want to set as a default.
- 5 To exit the Defaults view and save the changes, tap outside the view.

Ring tones, images, and call text for contacts

You can define a ringing tone for a contact or contact group, and an image and call text for a contact. When the contact calls you, the device plays the selected ringing tone and shows the call text or image (if the caller's phone number is sent with the call and your device recognizes it).

Select **Menu** > **Contacts**.

Add more fields to a contact details view

Select the contact and **Options** > **Edit** > **Options** > **Add detail**.

Define a ringing tone for a contact or contact group

Select the contact or contact group and **Options** > **Ringtone**, and select a ringing tone.

Remove the ringing tone from a contact

Select **Default tone** from the list of ringing tones.

Add an image for a contact

Select a contact saved in the device memory and **Options** > **Add image**, and select an image from **Gallery**.

Define a call text for a contact

Select the contact and **Options** > **Add call alert text**. Enter the call text, and select

**View, change or remove the image from a contact**

Select a contact and **Options** > **Image**, and the desired option.

Copy contacts

When you open the contacts list for the first time, the device asks if you want to copy names and numbers from the SIM card to your device.

To start copying, select **Yes**.

If you do not want to copy the contacts from the SIM card to your device, select **No**. The device asks if you want to view the SIM card contacts in the contacts directory. To view the contacts, select **Yes**. The contacts list opens, and the names stored on your SIM card are indicated with .

SIM services

For availability and information on using SIM card services, contact your SIM card vendor. This may be the network service provider or other vendor.

SIM contacts

The number of contacts that can be stored on the SIM card is limited.

Display contacts stored on the SIM card in the contacts list

Select **Options** > **Settings** > **Contacts to display** > **SIM memory**.

The numbers you save in the contacts list may not be automatically saved to your SIM card.

Copy contacts to the SIM card

Go to a contact, and select **Options** > **Copy** > **SIM memory**.

Select the default memory where to save the new contacts

Select **Options** > **Settings** > **Default saving memory** > **Phone memory** or **SIM memory**.

Contacts stored in the device memory can contain more than one phone number and an image.

Fixed dialling

With the fixed dialling service, you can restrict calls from your device to certain phone numbers. Not all SIM cards support the fixed dialling service. For more information, contact your service provider.

Select **Menu** > **Contacts and Options** > **SIM numbers** > **Fixed dial contacts**.

You need your PIN2 code to activate and deactivate fixed dialling or edit your fixed dialling contacts. Contact your service provider for your PIN2 code.

Select **Options** and from the following:

Activate fixed dialling or **Deactivate fixed dialling** — Activate or deactivate fixed dialling.

New SIM contact — Enter the contact name and phone number to which calls are allowed.

Add from Contacts — Copy a contact from the contacts list to the fixed dialling list.

To send text messages to the SIM contacts while the fixed dialling service is active, you need to add the text message centre number to the fixed dialling list.

Messaging

Messaging main view

Select **Menu** > **Messaging** (network service).

Create a new message

Select **New message**.

Tip: To avoid rewriting messages that you send often, use saved messages in the Templates folder in My folders. You can also create and save your own templates.

Messaging contains the following folders:

 **Inbox** — Received messages, except e-mail and cell broadcast messages.

 **My folders** — Organize your messages into folders.

 **Mailbox** — Connect to your remote mailbox to retrieve your new e-mail messages, or view your previously retrieved e-mail messages offline.

 **Drafts** — Draft messages that have not been sent.

 **Sent** — The last messages that have been sent, excluding messages sent using Bluetooth connectivity or infrared. You can define the number of messages that can be saved in this folder.

 **Outbox** — Messages waiting to be sent are temporarily stored in the Outbox, for example, when your device is outside network coverage.

 **Delivery reports** — Request the network to send you a delivery report of the text messages and multimedia messages you have sent (network service).

Write and send messages

Select Menu > Messaging.

Before you can create a multimedia message or write an e-mail, you must have the correct connection settings defined.

If the item you inserted in a multimedia message is too large for the network, the device may automatically reduce the size.

Only compatible devices can receive and display multimedia messages. Messages may look different in different devices.

Check the size limit of e-mail messages with your service provider. If you attempt to send an e-mail message that exceeds the size limit of the e-mail server, the message is left in the Outbox folder, and the device will attempt to resend it periodically. Sending an e-mail requires a data connection, and continuous attempts to resend the e-mail may incur charges from your service provider. In the Outbox folder, you can delete such message, or move it to the Drafts folder.

Messaging requires network services.

Send a text or multimedia message

Select **New message**.

Send an audio or e-mail message

Select **Options** > **Create message**, and the relevant option.

Select recipients or groups from the contacts list

Select  from the toolbar.

Enter the number or e-mail address manually

Tap the **To** field.

Enter the subject of the e-mail or multimedia message

Enter it in the **Subject** field, . If the **Subject** field is not visible, select **Options** > **Message header fields** to change the fields that are visible.

Write the message

Tap the message field.

Add an object to a message or e-mail

Select  and the relevant type of content.

The message type may change to multimedia message based on the inserted content.

Send the message or e-mail

Select , or press the call key.

You can send text messages that are longer than the character limit for a single message. Longer messages are sent as two or more messages. Your service provider may charge accordingly.

Characters with accents, other marks, or some language options, take more space, and limit the number of characters that can be sent in a single message.

Messaging inbox

Receive messages

Select **Menu** > **Messaging and Inbox**.



An unread text message



An unread multimedia message



An unread audio message



Data received through Bluetooth connectivity

When you receive a message,  and **1 new message** are displayed in the home screen.

Open a message from the home screen

Select **Show**.

Open a message in the Inbox folder

Select the message.

Reply to a received message

Select **Options** > **Reply**.

Multimedia messages

Select **Menu** > **Messaging**.

Retrieve multimedia messages

Select **Options** > **Retrieve**. A GPRS connection is opened to retrieve the message to your device. You may receive a notification that a multimedia message is waiting in the multimedia message center.

When you open a multimedia message () you may see an image and a message.  indicates that a sound clip is included.  indicates that a video is included.

Play the sound or video

Select the indicator.

View the media objects that have been included in a multimedia message

Select **Options** > **Objects**.

If the message includes a multimedia presentation,  is displayed.

Play the presentation

Select the indicator.

Data, settings, and web service messages

Your device can receive many kinds of messages that contain data, such as business cards, ringing tones, operator logos, calendar entries, and e-mail notifications. You may also receive settings from your service provider in a configuration message.

Save the data in a message

Select **Options** and the corresponding option.

Web service messages are notifications (for example, news headlines), and may contain a text message or a link. For availability and subscription, contact your service provider.

Set up your e-mail

To set up your e-mail, select **Menu > Messaging and Mailbox**.

You can set up several e-mail accounts, for example, a personal e-mail account and a corporate e-mail account.

To set up e-mail from your home screen, select the relevant plug-in. Alternatively, to set up an e-mail account, select **Menu > Applications > Tools > Sett. wizard**.

E-mail service

The e-mail service on your Nokia device automatically transfers e-mail from your existing e-mail address to your device. You can read, respond to, and organize your e-mails on the go. The service works with a number of internet e-mail providers that are often used for personal e-mail. Data charges may be applicable when using the service. For information on possible costs, contact your service provider

Set up e-mail on your Nokia device

- 1 Select **Menu > Applications > Tools > Sett. wizard**.
- 2 When the Settings wizard is opened for the first time, you are asked to define the e-mail settings after the service provider settings. If you have used the Settings wizard before, select **E-mail setup**.
- 3 Accept the terms and conditions to activate the e-mail service.

For more information, see nokia.com/messaging.

Mailbox

Define e-mail settings

Select **Menu > Messaging and Mailbox**.

To use e-mail, you must have defined a valid internet access point (IAP) in your device and have correctly defined your e-mail settings.

You must have a separate e-mail account. Follow the instructions given by your remote mailbox and internet service provider (ISP).

If you select **Messaging > Mailbox**, and have not set up your e-mail account, you are prompted to do so. To start defining the e-mail settings with the mailbox guide, select **Start**.

When you create a new mailbox, the name you give to the mailbox replaces Mailbox in the Messaging main view. You can have up to six mailboxes.

Open the mailbox

Select **Menu** > **Messaging** and a mailbox.

When you open the mailbox, the device asks if you want to connect to the mailbox.

Connect to your mailbox and retrieve new e-mail headers or messages

Select **Yes**. When you view messages online, you are continuously connected to a remote mailbox using a data connection.

View previously retrieved e-mail messages offline

Select **No**.

Create a new e-mail message.

Select **Options** > **Create message** > **E-mail**.

Close the data connection to the remote mailbox

Select **Options** > **Disconnect**.

Retrieve e-mail messages

Select **Menu** > **Messaging** and a mailbox.

If you are offline, select **Options** > **Connect** to open a connection to the remote mailbox.

Retrieve messages when you have an open connection to a remote mailbox

Select **Options** > **Retrieve e-mail** > **New** to retrieve all new messages, **Selected** to retrieve only selected messages, or **All** to retrieve all messages from the mailbox.

To stop retrieving messages, select **Cancel**.

Close the connection and view the e-mail messages offline

Select **Options** > **Disconnect**.

Open an e-mail message offline

To open an e-mail message, select the message. If the e-mail message has not been retrieved and you are offline, you are asked if you want to retrieve this message from the mailbox.

View e-mail attachments

Open the message, and select the attachment field indicated with . If the attachment has not been retrieved to the device, select **Options** > **Save**.

Retrieve e-mail messages automatically

Select **Options** > **E-mail settings** > **Automatic retrieval**.

Setting the device to retrieve e-mail automatically may involve the transmission of large amounts of data through your service provider's network. Contact your service provider for information about data transmission charges.

Delete e-mail messages

Select **Menu** > **Messaging** and a mailbox.

Delete the content of an e-mail from the device only

Select and hold the e-mail, and from the pop-up menu, select **Delete** > **Phone only**. The e-mail is not deleted from the remote mailbox.

The device mirrors the e-mail headers in the remote mailbox. If you delete the message content, the e-mail header stays in your device. If you want to remove the header as well, you must be connected to the server when deleting the message from your device and the remote mailbox. If there is no connection to the server, the header is deleted when you make a connection from your device to the remote mailbox again to update the status.

Delete an e-mail from the device and the remote mailbox

Select and hold the e-mail, and from the pop-up menu, select **Delete** > **Phone and server**.

Cancel deleting an e-mail that has been marked to be deleted from the device and server

Select **Options** > **Restore**.

Disconnect from the mailbox

When you are online, to end the data connection to the remote mailbox, select **Options** > **Disconnect**.

Mail for Exchange

With Mail for Exchange, you can receive your work e-mail to your device. You can read and reply to your e-mails, view and edit compatible attachments, view calendar information, receive and reply to meeting requests, schedule meetings, and view, add, and edit contact information.

Use of the Mail for Exchange is limited to over-the-air synchronization of PIM information between the Nokia device and the authorized Microsoft Exchange server.

Mail for Exchange can be set up only if your company has Microsoft Exchange Server. In addition, your company's IT administrator must have activated Mail for Exchange for your account.

Before starting to set up Mail for Exchange, ensure that you have the following:

- A corporate e-mail ID
- Your office network user name
- Your office network password
- Your network domain name (contact your company's IT department)
- Your Mail for Exchange server name (contact your company's IT department)

Depending on your company's Mail for Exchange server configuration, you may need to enter other information in addition to those listed. If you do not know the correct information, contact your company's IT department.

With Mail for Exchange, the use of the lock code may be mandatory. The default lock code of your device is 12345, but your company's IT administrator may have set a different one for you to use.

To access and edit the Mail for Exchange profile and settings, select **Menu > Settings > Phone > Application sett. > Messaging**.

View messages on a SIM card

You can view messages that are stored on a SIM card.

Select **Menu > Messaging and Options > SIM messages**.

Before you can view SIM messages, you must copy them to a folder in your device.

- 1 Mark the messages. Select **Options > Mark/Unmark > Mark** or **Mark all**.
- 2 Open a list of folders. Select **Options > Copy**.
- 3 Select a folder to copy.
- 4 To view the messages, open the folder .

Service commands

With service commands (network service) you can enter and send service requests (also known as USSD commands), such as activation commands for network services, to your service provider. This service may not be available for all regions.

Select **Menu > Messaging and Options > Service commands**.

Messaging settings

The settings may be preconfigured in your device, or you may receive them in a message. To enter settings manually, fill in all fields marked with **Must be defined** or an asterisk.

Some or all message centers or access points may be preset for your device by your service provider, and you may not be able to change, create, edit, or remove them.

Text message settings

Select **Menu > Messaging and Options > Settings > Text message**.

Select from the following:

Message centres — View a list of all text message centers that have been defined.

Message centre in use — Select which message center to use to deliver text messages.

Character encoding — To use character conversion to another encoding system when available, select **Reduced support**.

Receive report — Request the network to send you a delivery report of the text messages you have sent (network service).

Message validity — Select for how long the message center resends your message if the first attempt fails (network service). If the message cannot be sent within this time period, the message is deleted from the message center.

Message sent as — To find out if your message center is able to convert text messages into these other formats, contact your service provider.

Preferred connection — Select the connection to use.

Reply via same centre — Reply to messages using the same text message center number (network service).

Multimedia message settings

Select **Menu > Messaging and Options > Settings > Multimedia message**.

Select from the following:

Image size — Define the size of the image in a multimedia message.

MMS creation mode — If you select **Guided**, the device informs you if you try to send a message that may not be supported by the recipient. If you select **Restricted**, the device prevents you from sending messages that may not be supported. To include content in your messages without notifications, select **Free**.

Access point in use — Select which access point is used as the preferred connection.

Multimedia retrieval — Select how you want to receive messages, if available. To receive messages automatically in your home network, select **Auto in home netw..** Outside your home network, you receive a notification that there is a message to retrieve in the multimedia message center. If you select **Always automatic**, your device automatically makes an active GPRS connection to retrieve the message both in and

outside your home network. Select **Manual** to retrieve multimedia messages from the message center manually, or **Off** to prevent receipt of any multimedia messages. Automatic retrieval may not be supported in all regions.

Allow anonymous msgs. — Reject messages from anonymous senders.

Receive adverts — Receive multimedia message advertisements (network service).

Receive reports — Display the status of sent messages in the log (network service).

Deny report sending — Prevent your device from sending delivery reports of received messages.

Message validity — Select for how long the message center resends your message if the first attempt fails (network service). If the message cannot be sent within this time period, the message is deleted from the message center.

The device requires network support to indicate that a sent message has been received or read. Depending on the network and other circumstances, this information may not always be reliable.

Manage mailboxes

Select **Menu** > **Messaging and Options** > **Settings** > **E-mail**.

Select which mailbox you want to use to send and receive e-mail

Select **Mailbox in use** and a mailbox.

Remove a mailbox and its messages from your device

- 1 Select **Mailboxes**.
- 2 Select and hold the desired mailbox, and from the pop-up menu, select **Delete**.

Create a new mailbox

Select **Mailboxes** > **Options** > **New mailbox**. The name you give to the new mailbox replaces Mailbox in the Messaging main view. You can have up to six mailboxes.

Edit the connection settings, user settings, retrieval settings, and automatic retrieval settings

Select **Mailboxes** and a mailbox.

About Ovi Contacts

With Ovi Contacts, you can stay connected to the people who matter most. Search for contacts, and discover friends in the Ovi community. Keep in touch with your friends - chat, share your location and presence information, and easily follow what your friends are up to and where they are.

You can also sync your contacts, calendar, and other content between your Nokia device and Ovi. Your important information is stored and kept up to date both in your device and on the web. With Ovi Contacts, you can make your contacts list dynamic and be confident that your contacts are stored in Ovi.

You must have a Nokia account to use the service. Create an account on your cellular phone, or go to www.ovi.com on your PC.

Using Ovi Contacts may involve the transmission of large amounts of data through your service provider's network. For information about data transmission charges, contact your network service provider.

Connect to the service

Select **Menu** > **Contacts**, and open the Ovi tab.

Connect to Ovi Contacts

Select **Go online** and the connection method. Use a wireless LAN (WLAN) connection where available.

Close the connection

Select **Options** > **Sign out**.

A packet data connection may generate additional data transmission charges. For pricing details, contact your service provider.

Select **Go online** > **Options** and from the following:

Select — Select the item.

Go online — Connect to the service if you are offline.

My profile — Edit your profile information.

Recommend to friend — Invite a contact to join Ovi Contacts. The invitation is sent as a text message.

Settings — Change the Ovi Contacts settings.

Available options may vary.

Start using Ovi Contacts

Select **Contacts**, and open the Ovi tab.

The Ovi Contacts service is part of Ovi, and uses the same account information.

If you are new to Ovi and its services, to start using the Ovi Contacts application, you must register to Ovi by creating a Nokia account.

Create a Nokia account

- 1 Select **Ovi Chat**, and when prompted, connect to the internet.
- 2 Enter the required information.
- 3 In the My Profile view, enter your profile information. It is mandatory that you provide your first and last name.
- 4 Select **Done**.

If you have already registered with Ovi using your PC or mobile device, you can start using Ovi Contacts with the same account details.

Sign in to Ovi Contacts and activate the service

Select **Ovi Chat**, and enter your user name and password.

If you have not yet provided your profile information for Ovi Contacts, do so, and select **Done**. It is mandatory that you provide your first and last name.

Customize your device

You can customize your device by changing the home screen, tones, or themes.

Change the look of your device

 You can use themes to change the look of the display, such as background image and main menu layout.

Select **Menu > Settings and Personal > Themes**.

Activate a theme

Select **General** and the theme, and wait for a few seconds.

Change the layout of the main menu

Select **Menu**.

Change the look of the home screen

Select **Home scr. theme**.

Set an image or a slideshow as the background in the home screen

Select **Wallpaper > Image or Slide show**.

Change the image displayed in the home screen when a call is received

Select **Call image**.

Profiles

 You can use profiles to set and customize the ringing tones, message alert tones, and other tones for different events, environments, or caller groups. The name of the selected profile is displayed in the home screen. If the general profile is in use, only the date is displayed.

Select Menu > **Settings and Personal** > **Profiles**.

Music folder

Music player

Music player supports file formats such as AAC, AAC+, eAAC+, MP3, and WMA. Music player does not necessarily support all features of a file format or all the variations of file formats.

You can also use Music player to listen to podcasts. Podcasting is a method for delivering audio or video content over the internet using either RSS or Atom technologies for playback on cellular phones and computers.

Listen to music at a moderate level. Continuous exposure to high volume may damage your hearing.

Play music

Select Menu > **Music** > **Music player**.

Browse songs

Select the desired view. You can browse songs by artist, album, genre, or composer.

Play a song



Select the song.

Tip: To listen to the songs in a random order, select **Shuffle play**.

Pause and resume playback

To pause playback, select ; to resume, select .

Fast-forward or rewind a song

Select and hold  or .

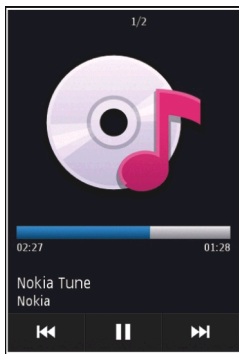

Tip: When listening to music, you can return to the home screen and leave the Music player application playing in the background.

Create a playlist

Want to listen to different music for different moods? With playlists, you can create selections of songs to play in a specific order.

Select **Menu** > **Music** > **Music player**.

- 1 Select **Playlists**.
- 2 Select **Options** > **New playlist**.
- 3 Enter a name for the playlist, and select **OK**.
- 4 Select the songs to add to the playlist, in the order you want them to play.

If a compatible memory card is inserted, the playlist is saved to the memory card.

Add a song to a playlist

Select and hold the song, and from the pop-up menu, select **Add to playlist**.

Remove a song from playlist

In the playlist view, select and hold the song, and from the pop-up menu, select **Remove**.

This does not delete the song from the device; it only removes it from the playlist.

Play a playlist

Select **Playlists** and the playlist.

Tip: Music player automatically creates a playlist for the most played songs, recently played songs, and recently added songs.

Podcasts

Select **Menu > Music > Music player and Podcasts**.

Podcast episodes have three states: never played, partially played, and completely played. If the state is partially played, the episode plays from the last playback position the next time it is played. If the state is never played or completely played, the episode plays from the beginning.

Nokia Ovi Player

With Nokia Ovi Player, you can download music from Ovi Music, transfer your music to your device from your computer, and manage and organize your music files. To download Nokia Ovi Player, go to www.ovi.com.

You need an internet connection to download music.

Download, transfer, and manage music between your computer and cellular phone

- 1 Open Nokia Ovi Player on your computer. If you want to download music, register or sign in.
- 2 Connect your device to the computer with a compatible USB data cable.
- 3 To select the connection mode on your device, select **Media transfer**.

Ovi Music

With Ovi Music (network service), you can search, browse, purchase, and download music to your device.

The Ovi Music service will eventually replace the Music store.

Select **Menu > Music > Ovi Music**.

To download music, you first need to register for the service.

Downloading music may involve additional costs and the transmission of large amounts of data (network service). For information about data transmission charges, contact your network service provider.

To access Ovi Music, you must have a valid internet access point in the device. You may be asked to select the access point to use when connecting to Ovi Music.

Select the access point

Select **Default access point**.

The availability and appearance of Ovi Music settings may vary. The settings may also be predefined and you may not be able to modify them. When browsing Ovi Music, you may be able to modify the settings.

Modify Ovi Music settings

Select **Options** > **Settings**.

Ovi Music is not available for all countries or regions.

Nokia Podcasting

With the Nokia Podcasting application (network service), you can search, discover, subscribe to, and download podcasts over the air, and play, manage, and share audio and video podcasts with your device.

Podcasting settings

Select **Menu** > **Music** > **Podcasting**.

To start using Podcasting, define your connection and download settings.

Connection settings

Select **Options** > **Settings** > **Connection** and from the following:

Default access point — Select the access point to use to connect to the internet.

Search service URL — Define the podcast search service web address, to use to search for podcasts.

Download settings

Select **Options** > **Settings** > **Download** and from the following:

Save to — Define where to save podcasts.

Update interval — Define how often podcasts are updated.

Next update time — Define the time of the next automatic update.

Automatic updates only occur if a specific default access point is selected and the Podcasting application is open.

Download limit (%) — Define the percentage of memory that is reserved for podcast downloads.

If limit exceeds — Define what to do if the download limit is exceeded.

Setting the application to retrieve podcasts automatically may involve the transmission of large amounts of data through your service provider's network. For information on data transmission charges, contact your service provider.

Restore default settings

Select **Options** > **Restore default**.

Download podcasts

After you have subscribed to a podcast, you can download, play, and manage the podcast episodes.

Select **Menu** > **Music** > **Podcasting**.

View a list of subscribed podcasts

Select **Podcasts**.

View individual episode titles

Select the podcast title.

An episode is a particular media file of a podcast.

Start a download

Select the episode title.

You can download multiple episodes at the same time.

Start playing a podcast before the download is complete

Select and hold a podcast, and from the pop-up menu, select **Play preview**.

Successfully downloaded podcasts are stored in the Podcasts folder, but may not be displayed immediately.

Radio

Listen to the radio

Select **Menu** > **Music** > **Radio**.

To listen to the radio, you need to attach a compatible headset to the device. The headset acts as an antenna.

When you open the application for the first time, you can choose to have the local stations tuned automatically.

To listen to the next or the previous station, select  or .

To mute the radio, select .

Select **Options** and from the following:

Stations — View saved radio stations.

Tune stations — Search for radio stations.

Save — Save the radio station.

Activate loudspeaker or **Deactivate loudspeaker** — Turn the loudspeaker on or off.

Alternative frequencies — Select whether you want the radio to automatically search for a better RDS frequency for the station if the frequency level becomes low.

Play in background — Return to the home screen with the radio playing in the background.

Manage radio stations

Select **Menu** > **Music** > **Radio**.

To listen to saved stations, select **Options** > **Stations**, and select a station from the list.

To remove or rename a station, select and hold the station, and from the pop-up menu, select **Delete** or **Rename**.

To set the desired frequency manually, select **Options** > **Tune stations** > **Options** > **Manual tuning**.

Camera

Your device supports an image capture resolution of 2592 x 1944 pixels. The image resolution in this guide may appear different.

Activate the camera

To activate the camera, select **Menu** > **Applications** > **Camera**.

Image capture

Capture an image

Select **Menu** > **Applications** > **Camera**.

When capturing an image, note the following:

- Use both hands to keep the camera steady.
- The quality of a digitally zoomed image is lower than that of a non-zoomed image.
- The camera goes into battery saving mode after about a minute of inactivity.

To switch from video mode to image mode, if necessary, select  > .

Zoom in or out when capturing an image

Use the zoom slider.

After capturing an image

After you capture an image, select from the following options (available only if you have selected **Options** > **Settings** > **Show captured image** > **Yes**):

 — Send the image in a multimedia or e-mail message, or through connection methods such as Bluetooth connectivity.

To send the image to the person you are talking to, select  during a call.

 — Upload the image to a compatible online album.

 **Delete** — Delete the image.

Use the image as wallpaper in the home screen

Select **Options** > **Use image** > **Set as wallpaper**.

Set the image as a default call image

Select **Options** > **Use image** > **Set as call image**.

Assign the image to a contact

Select **Options** > **Use image** > **Assign to contact**.

Return to the viewfinder to capture a new image

Select **Back**.

Scenes

A scene helps you to find the right color and lighting settings for the current environment. The settings of each scene have been set according to a certain style or environment.

The default scene in image and video modes is indicated with  (**Automatic**).

Change the scene

Select  > **Scene modes** and a scene.

Create your own scene suitable for a certain environment

Select **User defined** > **Change**. In the user defined scene, you can edit different lighting and color settings.

Copy the settings of another scene

Select **Based on scene mode** and the desired scene. To save the changes and return to the scenes list, select **Back**.

Activate your own scene

Select **User defined** > **Select**.

Location information



You can automatically add capture location information to the file details of the captured material.

Select **Menu** > **Applications** > **Camera**.

To add location information to all captured material, select **Options** > **Settings** > **Show GPS info** > **On**.

It may take several minutes to obtain the coordinates of your location. The availability and quality of GPS signals may be affected by your location, buildings, natural obstacles, and weather conditions. If you share a file that includes location information, the location information is shared and your location may be visible to third parties viewing the file. The device requires network services to acquire location information.

Location information indicators:

 — Location information unavailable. GPS stays on in the background for several minutes. If a satellite connection is found and the indicator changes to  within that time, all the images captured and video clips recorded during that time are tagged based on the received GPS positioning information.

 — Location information is available. Location information is added to the file details.

Location information can be added to an image or a video clip if location coordinates are found via the network. It may take several minutes to receive the coordinates. The best conditions are obtained in open areas away from high buildings.

If you share your image or video which has location information attached to it, the location information is also shared and your location may be visible to third parties that can view the image or the video.

You may disable the geotagging service in camera settings.

Self-timer

Use the self-timer to delay the capture, so that you can include yourself in the image.

Set the self-timer delay

Select  >  and the delay desired before the image is captured.

Activate the self-timer

Select **Activate**. The stopwatch icon on the screen blinks and the remaining time is displayed when the timer is running. The camera captures the image after the selected delay elapses.



Deactivate the self-timer

Select  > .

Tip: To keep your hand steady when capturing an image, try using a delay of 2 seconds.



Video recording**Record a video**

Select **Menu** > **Applications** > **Camera**.

- 1 To switch from image mode to video mode, if necessary, select  > .
- 2 To pause recording, select **Pause**. To resume, select **Continue**. If you pause recording and do not press any key within one minute, the recording stops. To zoom in or out, use the zoom keys.
- 3 To stop recording, select **Stop**. The video is automatically saved in Gallery.

After recording a video

After you record a video, select from the following (available only if you have selected **Options** > **Settings** > **Show last captured video** > **Yes**):

-  **Play** — Play the video you just recorded.
-  — Upload the image to a compatible online album.
-  **Delete** — Delete the video.

To return to the viewfinder to record a new video, select **Back**.

Gallery

To store and organise your images, videos, sound clips, and streaming links, select **Menu** > **Gallery**.

View and organize files

Select **Menu** > **Gallery**.

Select from the following:

 **Images & videos** — View images in the image viewer and videos in Video center.

 **Songs** — Open Music player.

 **Sound clips** — Listen to sound clips.

 **Other media** — View presentations.

 indicates files stored on your compatible memory card (if inserted).

Open a file

Select a file from the list. Videos and files with the .ram file extension open and play in Video center, and music and sound clips in Music player.

Copy or move files

To copy or move files to the memory card (if inserted) or device memory, select a file, **Options** > **Organise** > **Copy** or **Move**, and the appropriate option.

View images and videos

Select **Menu** > **Gallery** and **Images & videos**.

By default, the images, videos, and folders are organized by date and time.

To open a file, select a file from the list. To zoom in an image, use the volume key.

To edit a video or an image, select **Options** > **Edit**.

Select an image, **Options** > **Use image**, and from the following:

Set as wallpaper — Use the image as wallpaper in the home screen.

Set as call image — Set the image as a default call image

Assign to contact — Set the image as a call image for a contact.

Select a video, **Options** > **Use video clip**, and from the following:

Assign to contact — Assign the video as a ringing tone for a contact.

As ringing tone — Set the video as a ringing tone.

The toolbar helps you select frequently used functions with images, videos, and folders.

From the toolbar, select from the following:

 **Send** — Send your image or video.

 **Delete** — Delete an image or a video.

Organize images and video

Select **Menu** > **Gallery**.

Create a new folder

Select **Images & videos** > **Options** > **Folder options** > **New folder**.

Move a file

Select the file and **Options** > **Folder options** > **Move to folder**.

Share online

About Share online

Select **Menu** > **Applications** > **Share online**.

With Share online (network service), you can post your images, video clips, and sound clips from your device to compatible online sharing services, such as albums and blogs. You can also view and send comments to the posts in these services, and download content to your compatible Nokia device.

The supported content types and the availability of the Share online service may vary.

Subscribe to an online sharing service

Select **Menu** > **Applications** > **Share online**.

- 1 Go to the service provider's website, and make sure your Nokia device is compatible with the service.
- 2 Create an account as instructed on the website. You receive a username and password needed to set up your device with the account.

Activate a service

- 1 Select and hold the service, and from the pop-up menu, select **Activate**.
- 2 Allow the device to open a network connection. If prompted, select an internet access point from the list.
- 3 Sign in to your account as instructed on the service provider's website.

For the availability and cost of the third party services and data transfer costs, contact your service provider or the relevant third party.

Manage your accounts

To view your accounts, select **Options** > **Settings** > **My accounts**.

To create a new account, select **Options** > **Add new account**.

To change the user name or password for an account, select and hold the account name, and from the pop-up menu, select **Edit**.

To set an account as the default when sending posts from your device, select and hold the account name, and from the pop-up menu, select **Set as default**.

To remove an account, select and hold the account name, and from the pop-up menu, select **Delete**.

Create a post

Select **Menu** > **Applications** > **Share online**.

To post your images or video clips to a service, select and hold the service, and from the pop-up menu, select **New upload**. If the online sharing service provides channels for posting files, select the desired channel.

To add your image, video, or sound clip to the post, select **Options** > **Add**.

Enter a title or description for the post, if available.

To add tags to the post, select **Tags**.

To enable the posting of location information contained in the file, select **Location**.

To send the post to the service, select **Options** > **Upload**.

Post files from Gallery

You can post your images and videos from Gallery to an online sharing service.

- 1 Select **Menu** > **Gallery** and your images and videos to post.
- 2 Select **Options** > **Send** > **Upload** and the desired account.
- 3 Edit your post as required.
- 4 Select **Options** > **Upload**.

Nokia Video Center

With Nokia Video Center (network service), you can download and stream videos over the air from compatible internet video services using a packet data or Wi-Fi connection.

You can also transfer your video clips from a compatible PC to your device and view them in Video center.

Using packet data access points to download videos may involve the transmission of large amounts of data through your service provider's network. Contact your service provider for information about data transmission charges.

Your device may have predefined services.

Service providers may provide free content or charge a fee. Check the pricing in the service or from the service provider.

View and download video clips

Connect to video services

- 1 Select **Menu** > **Applications** > **Video centre**.
- 2 To connect to a service to install video services, select **Add new services** and the desired video service from the service catalog.

View a video clip

To browse the content of installed video services, select **Video feeds**.

The content of some video services is divided into categories. To browse video clips, select a category.

To search for a video clip in the service, select **Video search**. Search may not be available in all services.

Some video clips can be streamed over the air, but others must be first downloaded to your device. To download a video clip, select **Options** > **Download**. Downloads continue in the background if you exit the application. The downloaded video clips are saved in My videos.

To stream a video clip or view a downloaded one, select **Options** > **Play**.

When the video clip is playing, to use the control keys for controlling the player, tap the screen.

To adjust the volume, use the volume key.

Select **Options** and from the following:

Resume download — Resume a paused or failed download.

Cancel download — Cancel a download.

Preview — Preview a video clip. This option is available if supported by the service.

Feed details — View information about a video clip.

Refresh list — Refresh the list of video clips.

Open link in browser — Open a link in the web browser.

Schedule downloads

Setting the application to download video clips automatically may involve the transmission of large amounts of data through your service provider's network. For information about data transmission charges, contact your service provider.

To schedule an automatic download for video clips in a service, select **Options** > **Schedule downloads**.

Video center automatically downloads new video clips daily at the time you define.

To cancel scheduled downloads, select **Manual download** as the download method.

Video feeds

Select **Menu** > **Applications** > **Video centre**.

The content of the installed video services is distributed using RSS feeds. To view and manage your feeds, select **Video feeds**.

Select **Options** and from the following:

Feed subscriptions — Check your current feed subscriptions.

Feed details — View information about a video.

Add feed — Subscribe to new feeds. Select **Via Video directory** to select a feed from the services in the video directory.

Refresh feeds — Refresh the content of all feeds.

Manage account — Manage your account options for a particular feed, if available.

To view the videos available in a feed, select a feed from the list.

My videos

My videos is a storage place for all videos in the Video center application. You can list downloaded videos and video clips recorded with the device camera in separate views.

- 1 To open a folder and view video clips, select the folder. When a video clip is playing, to use the control keys for controlling the player, tap the screen.
- 2 To adjust the volume, press the volume key.

Select **Options** and from the following:

Resume download — Resume a paused or failed download.

Cancel download — Cancel a download.

Video details — View information about a video clip.

Find — Find a video clip. Enter a search term that matches the file name.

Memory status — View the amount of free and used memory.

Sort by — Sort video clips. Select the desired category.

Move and copy — Move or copy video clips. Select **Copy** or **Move** and the desired location.

Transfer videos from your PC

Transfer your own videos from compatible devices using a compatible USB data cable. Only videos which are in a format supported by your device are displayed.

- 1 To view your device on a PC as a mass memory device where you can transfer any data files, connect using a compatible USB data cable.
- 2 Select **Mass storage** as the connection mode. A compatible memory card needs to be inserted in the device.
- 3 Select the video clips you want to copy from your PC.
- 4 Transfer the videos to **E:\My Videos** on the memory card.
The transferred videos appear in the My videos folder.

Video center settings

In the Video center main view, select **Options** > **Settings** and from the following:

Video service selection — Select the video services that you want to appear in Video center. You can also add, remove, edit, and view the details of a video service. You cannot edit preinstalled video services.

Connection settings — To define the network destination used for the network connection, select **Network connection**. To select the connection manually each time Video center opens a network connection, select **Always ask**.

To set GPRS connection on or off, select **Confirm GPRS usage**.

To set roaming on or off, select **Confirm roaming**.

Parental control — Set an age limit to videos. The required password is the same as the device lock code. The factory setting for the lock code is **12345**. In video-on-demand services, videos which have the same or a higher age limit than you have set, are hidden.

Preferred memory — Select whether downloaded videos are saved in the device memory or on a compatible memory card.

Thumbnails — Select whether to download and view thumbnail images in video feeds.

Web browser

With the web browser, you can view hypertext markup language (HTML) pages on the web as originally designed (network service). You can also browse web pages that are designed specifically for cellular phones, and use extensible hypertext markup language (XHTML), or the wireless markup language (WML).

To browse the web, you need to have an internet access point defined in your device.

Browse the web

Select **Menu** > **Web**.

Tip: If you do not have a flat-rate data plan from your service provider, to save data costs in your phone bill, you can use a Wi-Fi network to connect to the internet.

Go to a web page

From the toolbar, select , and enter a web address.

A cache is a memory location that is used to store data temporarily. If you have, or have tried to, access confidential information or a secure service, requiring passwords, clear the cache after each use.



Empty the cache

Select **Options** > **Clear privacy data** > **Cache**.

Add a bookmark

If you visit the same websites all the time, add them to your Bookmarks view, so you can easily access them.

Select **Menu** > **Web**.

While browsing, select  > .

Go to a bookmarked website while browsing

Select  and a bookmark.

Subscribe to a web feed

You don't have to visit your favorite websites regularly to keep up with what's new on them. You can subscribe to web feeds and get links to latest content automatically.

Select **Menu** > **Web**.

Web feeds on web pages are usually indicated with . They are used to share, for example, the latest news headlines or blog entries.

Subscribe to a feed

Go to a blog or web page that contains a web feed, and select **Options > Subscribe to web feeds**.

Manually update a feed

In the Web feeds view, select the feed.

Set feeds to automatically update

In the Web feeds view, select and hold the feed, and from the pop-up menu, select **Edit > Automatic updates**.

Discover nearby events

Are you looking for interesting things to do near your current location? With Here and now, you can get information about, for example, the weather, events, cinema times, or restaurants nearby.

Select **Menu > Web**.

- 1 Select **Here and now**.
- 2 Browse the available services, and for more information, select the service.

Some content is generated by third parties and not Nokia. The content may be inaccurate and is subject to availability.

Some services may not be available in all countries, and may be provided only in selected languages. The services may be network dependent. For more information, contact your network service provider.

Using the service or downloading content may cause transfer of large amounts of data, which may result in data traffic costs.

Positioning (GPS)

You can use applications such as GPS data to calculate your location or measure distances. These applications require a GPS connection.

About GPS

The availability and quality of GPS signals may be affected by your location, satellite positions, buildings, natural obstacles, weather conditions and adjustments to GPS

satellites made by the United States government. GPS signals may not be available inside buildings or underground.

Do not use GPS for precise location measurement, and never rely solely on the location information provided by GPS and cellular networks.

The coordinates in the GPS are expressed using the international WGS-84 coordinate system. The availability of the coordinates may vary by region.

About assisted GPS (A-GPS)

Your device supports A-GPS (network service). When you activate A-GPS, your device receives useful satellite information from an assistance data server over the cellular network. With the help of assisted data, your device can obtain the GPS position faster.

Your device is preconfigured to use the Nokia A-GPS service, if no service provider-specific A-GPS settings are available. The assistance data is retrieved from the Nokia A-GPS service server only when needed.

You must have an internet access point defined in the device to retrieve assistance data from the Nokia A-GPS service over a packet data connection.

Define an access point for A-GPS

Select **Menu > Applications > Location and Positioning > Positioning server > Access point**. Only a packet data internet access point can be used for this service. Your device asks for the internet access point when GPS is used for the first time.

Hold your device correctly

When using the GPS receiver, ensure you do not cover the antenna with your hand.

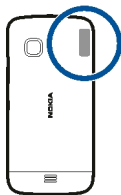

Establishing a GPS connection may take from a couple of seconds to several minutes. Establishing a GPS connection in a vehicle may take longer.

The GPS receiver draws its power from the device battery. Using the GPS receiver may drain the battery faster.

Tips on creating a GPS connection

Check satellite signal status

Select **Menu > Applications > Location and GPS data > Options > Satellite status.**

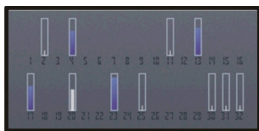

If your device has found satellites, a bar for each satellite is shown in the satellite info view. The longer the bar, the stronger the satellite signal. When your device has received enough data from the satellite signal to calculate your location, the bar color changes.

Initially your device must receive signals from at least four satellites to be able to calculate the coordinates of your location. When the initial calculation has been made, it may be possible to continue calculating the coordinates of your location with three satellites. However, the accuracy is generally better when more satellites are found.

To view the positions of found satellites, select **Chg. view.**

If no satellite signal can be found, consider the following:

- If you are indoors, go outdoors to receive a better signal.
- If you are outdoors, move to a more open space.
- If the weather conditions are bad, the signal strength may be affected.
- Some vehicles have tinted (athermic) windows, which may block the satellite signals.

Ensure you do not cover the antenna with your hand.

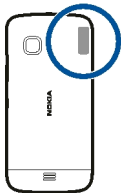

Establishing a GPS connection may take from a couple of seconds to several minutes. Establishing a GPS connection in a vehicle may take longer.

The GPS receiver draws its power from the device battery. Using GPS may drain the battery faster.

Position requests

You may receive a request from a network service to receive your position information. Service providers may offer information about local topics, such as weather or traffic conditions, based on the location of your device.

When you receive a position request, the service that is making the request is displayed. Select **Accept** to allow your position information to be sent or **Reject** to deny the request.

Landmarks

 With Landmarks, you can save the position information of locations in your device. You can sort the saved locations into different categories, such as business, and add details to them. You can use your saved landmarks in compatible applications.

Select **Menu** > **Applications** > **Location and Landmarks**.

Select **Options** and from the following:

New landmark — Create a new landmark. To request position information of your current location, select **Current position**. To enter the position information manually, select **Enter manually**.

Edit — Edit a saved landmark (for example, add a street address).

Add to category — Add a landmark to a category. Select each category to which you want to add the landmark.

Send — Send one or several landmarks to a compatible device.

Create a new landmark category

On the categories tab, select **Options** > **Edit categories**.

GPS data

GPS data is designed to provide route guidance information to a selected destination and traveling information, such as the approximate distance to the destination and approximate duration of travel. You can also view position information about your current location.

Select **Menu** > **Applications** > **Location and GPS data**.

Positioning settings

Positioning settings define the methods, server, and notation settings used in positioning.

Select **Menu > Applications > Location and Positioning**.

Define positioning methods

Use only the integrated GPS receiver of your device

Select **Integrated GPS**.

Use Assisted GPS (A-GPS) to receive assistance data from a positioning server

Select **Assisted GPS**.

Use information from the cellular network (network service)

Select **Network based**.

Define positioning server

Define an access point and positioning server for network-assisted positioning

Select **Positioning server**.

This is used for assisted GPS or network-based positioning. The positioning server may be preset by your service provider, and you may not be able to edit the settings.

Define notation settings

Select the measurement system to use for speeds and distances

Select **Measurement system > Metric or Imperial**.

Define in which format the coordinate information is displayed in your device

Select **Coordinate format** and the desired format.

Maps

Maps overview

 Select **Menu > Maps**.

Welcome to Maps.

Maps shows you what is nearby, helps you plan your route, and guides you where you want to go.

- Find cities, streets, and services.
- Find your way with turn-by-turn directions.

- Synchronize your favorite locations and routes between your cellular phone and the Ovi Maps internet service.
- Check weather forecasts and other local information, if available.

Some services may not be available in all countries, and may be provided only in selected languages. The services may be network dependent. For more information, contact your network service provider.

Using the service or downloading content may cause transfer of large amounts of data, which may result in data traffic costs.

Almost all digital cartography is inaccurate and incomplete to some extent. Never rely solely on the cartography that you download for use in this device.

Some content is generated by third parties and not Nokia. The content may be inaccurate and is subject to availability.

View your location and the map

See your current location on the map, and browse maps of different cities and countries.

Select **Menu** > **Maps** and **My position**.

 indicates your current position, if available. When searching for your position,  blinks. If your position is not available,  indicates your last known position.

If accurate positioning is not available, a red halo around the positioning icon indicates the general area you might be in. In densely populated areas, the accuracy of the estimate increases, and the red halo is smaller than in lightly populated areas.

Browse the map

Drag the map with your finger. By default, the map is oriented north.

View your current or last known location

Select .

Zoom in or out

Select **+** or **-**.

Tip: To zoom, you can also place two fingers on the map, and slide your fingers apart to zoom in or together to zoom out. Not all devices support this feature.

If you browse to an area not covered by the street maps that are stored on your device, and you have an active data connection, new street maps are automatically downloaded.

To prevent downloading new street maps automatically, in the main menu, select  > **Internet** > **Connection** > **Offline**.

Map coverage varies by country and region.

Map view



- 1 Selected location
- 2 Indicator area
- 3 Point of interest (for example, a railroad station or a museum)
- 4 Information area
- 5 Compass

Change the look of the map

View the map in different modes, to easily identify where you are.

Select **Menu** > **Maps and My position**.

Select  and from the following:

Map view — In the standard map view, details such as location names or highway numbers, are easy to read.

Satellite view — For a detailed view, use satellite images.

Terrain view — View at a glance the ground type, for example, when you are traveling off-road.

3D view — For a more realistic view, change the perspective of the map.

Landmarks — Display prominent buildings and attractions on the map.

Night mode — Dim the colors of the map. When traveling at night, the map is easier to read in this mode.

Transit lines — View selected public transportation services, such as metro and trolley routes.

The available options and features may vary by region. The unavailable options are dimmed.

Download and update maps

To avoid cellular data transfer costs, download the latest street maps and voice guidance files to your computer, and then transfer and save them to your device.

Use the Nokia Ovi Suite application to download the latest street maps and voice guidance files to your compatible computer. To download and install Nokia Ovi Suite, go to www.ovi.com.

Tip: Save new street maps to your device before a journey, so you can browse the maps without an internet connection when traveling abroad.

If you have an older version of the Maps application installed on your device, when you update to the latest version, the country or region maps are deleted. Before using Nokia Ovi Suite to download new country or region maps, open and close the Maps application.

Make sure you have the latest version of Nokia Ovi Suite installed on your computer.

About positioning methods

Maps displays your location on the map using GPS, A-GPS, Wi-Fi, or network (cell ID) based positioning.

The global positioning system (GPS) is a satellite-based navigation system used for calculating your location. Assisted GPS (A-GPS) is a network service that sends you GPS data, improving the speed and accuracy of the positioning.

Wi-Fi network positioning improves position accuracy when GPS signals are not available, especially when you are indoors or between tall buildings.

With network (cell ID) based positioning, the position is determined through the antenna system your cellular phone is currently connected to.

When you use Maps for the first time, you are prompted to define the internet access point to use to download map information, use A-GPS, or connect to a Wi-Fi network.

To avoid network service costs, you can disable A-GPS, Wi-Fi, and network (cell ID) based positioning in your device positioning settings, but calculating your location may take much longer. For more information about positioning settings, see the user guide of your device.

The availability and quality of GPS signals may be affected by your location, satellite positions, buildings, natural obstacles, weather conditions and adjustments to GPS satellites made by the United States government. GPS signals may not be available inside buildings or underground.

Do not use GPS for precise location measurement, and never rely solely on the location information provided by GPS and cellular networks.

The trip meter may not be accurate, depending on the availability and quality of your GPS connection.

 **Note:** Using WLAN may be restricted in some countries. For example, in France, you are only allowed to use WLAN indoors. For more information, contact your local authorities.

Depending on the available positioning methods, the accuracy of positioning may vary from a few metres to several kilometers.

Find a location

Maps helps you find specific locations and businesses.

Select **Menu** > **Maps** and **Search**.

- 1 Enter search words, such as a street address or place name.
- 2 Select .
- 3 Select an item from the list of proposed matches.
The location is displayed on the map.

Return to the list of proposed matches

Select **Search**.

Tip: In the search view, you can also select from the list of your previous search words.

Search for different types of nearby places

Select **Categories** and a category, such as shopping, accommodation, or transport.

If no search results are found, make sure the spelling of your search words is correct. Problems with your internet connection may also affect results when searching online.

If you have maps of the searched area stored on your device, you can also get search results without an active internet connection, to avoid data transfer costs, but the search results may be limited.

View location details

Find more information about a specific location or place, such as a hotel or restaurant, if available.

The available options may vary by region. To view all the available place details, you need an active internet connection.

Select **Menu** > **Maps and Search**.

View the details of a place

Search for a place. Select the place and its information area.

Rate a place

Search for a place. Select the place, its information area, **Rate**, and the star rating. For example, to rate a place as being 3 out of 5 stars, select the third star.

When you find a place that does not exist or contains inappropriate information or incorrect details, such as the wrong contact information or location, it is recommended that you report it to Nokia.

Report incorrect place information

Select the place, its information area, **Report**, and the appropriate option.

Save or view a place or route

Save an address, place of interest, or route, so it can be quickly used later.

Select **Menu** > **Maps**.

Save a place

- 1 Select **My position**.
- 2 Tap the location. To search for an address or place, select **Search**.
- 3 Tap the location's information area.
- 4 Select **Save**.

Save a route

- 1 Select **My position**.
- 2 Tap the location. To search for an address or place, select **Search**.
- 3 Tap the location's information area.
- 4 To add another route point, select **Navigate** > **Add to route**.
- 5 Select **Add new route point** and the appropriate option.
- 6 Select **Show route** > **Options** > **Save route**.

View a saved place

In the main view, select **Favourites** > **Places**, the place, and **Show on map**.

View a saved route

In the main view, select **Favourites** > **Routes** and the route.

Send a place to a friend

When you want to show your friends where a place is on the map, you can send the place to them.

Select **Menu** > **Maps** and **My position**.

To view the place on the map, your friends don't need to have a Nokia cellular phone, but an active internet connection is required.

- 1 Select a place and its information area.
- 2 Select **Share** > **Share via SMS** or **Share via Email**.

A mail or text message containing a link to the location on the map is sent to your friend.

Check in

With the Check in feature, you can keep a private record of where you have been. Keep your social networking friends and contacts up to date with what you are doing, and share your location on your favorite social networking services.

Select **Menu** > **Maps** and **Check in**.

To check in, you need a Nokia account. To share your location, you also need a social networking service account. The supported social networking services vary by country or region.

- 1 Sign in to your Nokia account, or, if you do not yet have one, create the account.
- 2 It is possible to share your location on the social networking services that you use. When you use Check in for the first time, you can set your account credentials for the services that you use. To later set up accounts, select .
- 3 Select your current location.
- 4 Write your status update.
You can post only to selected services that you have set up. To exclude a service, select the service logo. To exclude all the services, keeping your location and status update private, clear the **and post on** check box.
- 5 Select **Check in**.

You may also be able to attach a picture to your post, depending on the social networking service.

View your Check in history

Select .

Checking in and sharing your location requires an internet connection. This may involve the transmission of large amounts of data and related data traffic costs.

The terms of use of the social networking service apply to sharing your location on that service. Familiarize yourself with the terms of use and the privacy practices of that service.

Before sharing your location to others, always consider carefully with whom you are sharing it. Check the privacy settings of the social networking service you are using, as you might share your location with a large group of people.

Synchronize your Favorites

Plan a trip on your computer at the Ovi Maps website, synchronize the saved places and routes with your cellular phone, and access the plan on the go.

To synchronize places or routes between your cellular phone and the Ovi Maps internet service, you need to be signed in to your Nokia account.

Synchronize saved places and routes

Select **Favourites > Synchronise with Ovi**. If you do not have a Nokia account, you are prompted to create one.

You can set your device to synchronize your Favorites automatically when you open or close the Maps application.

Synchronize Favorites automatically

Select  > **Synchronisation > Synchronisation > At start-up and shut-d..**

Synchronizing requires an active internet connection, and may involve the transmission of large amounts of data through your service provider's network. For information about data transmission charges, contact your service provider.

To use the Ovi Maps internet service, go to www.ovi.com.

Get voice guidance

Voice guidance, if available for your language, helps you find your way to a destination, leaving you free to enjoy the journey.

Select **Menu** > **Maps** and **Drive** or **Walk**.

When you use drive or walk navigation for the first time, you are asked to select the language of the voice guidance, and download the appropriate files.

If you select a language that includes street names, also the street names are said aloud. Voice guidance may not be available for your language.

Change the voice guidance language

In the main view, select  and **Navigation** > **Drive guidance** or **Walk guidance** and the appropriate option.

Deactivate voice guidance

In the main view, select  and **Navigation** > **Drive guidance** or **Walk guidance** and **None**.

Repeat the voice guidance for car navigation

In the navigation view, select **Options** > **Repeat**.

Adjust the volume of the voice guidance for car navigation

In the navigation view, select **Options** > **Volume**.

Use the compass

When the compass is activated, both the arrow of the compass and the map rotate automatically in the direction to which the top of your device is pointing.

Select **Menu** > **Maps** and **My position**.

Activate the compass

Select .

Deactivate the compass

Select  again. The map is oriented north.

The compass is active when it is green. If the compass needs calibration, the compass is red.

Calibrate the compass

Rotate the device around all axes in a continuous movement until the compass turns green.

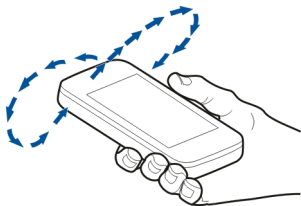

The compass has limited accuracy. Electromagnetic fields, metal objects, or other external circumstances may also affect the accuracy of the compass. The compass should always be properly calibrated.

Drive to your destination

When you need turn-by-turn directions while driving, Maps helps you get to your destination.

Select **Menu** > **Maps and Drive**.

Drive to a destination

Select **Set destination** and the appropriate option.



Drive to your home

Select **Drive home**.

You can start driving without a set destination. The map follows your location, and traffic information is automatically displayed, if available. To set the destination later, select **Destination**.

By default, the map rotates to your driving direction.

Orient the map to north

Select . To rotate the map back to your driving direction, select .

When you select **Drive home** or **Walk home** for the first time, you are prompted to define your home location.

Change your home location

- 1 In the main view, select .
- 2 Select **Navigation** > **Home Location** > **Redefine**.
- 3 Select the appropriate option.

Change views during navigation

Swipe left to select **2D view**, **3D view**, **Arrow view**, or **Route overview**.

Obey all local laws. Always keep your hands free to operate the device while driving. Your first consideration while driving should be road safety.

Navigation view

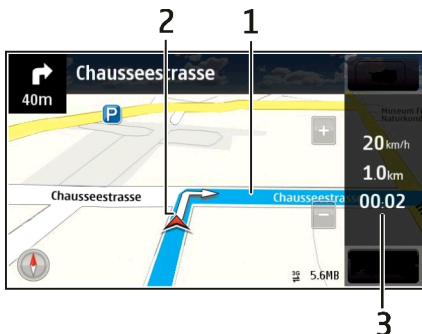

- 1 Route
- 2 Your location and direction
- 3 Information bar (speed, distance, time)

Get traffic and safety information

Enhance your driving experience with real-time information about traffic events, lane assistance, and speed limit warnings, if available for your country or region.

Select **Menu > Maps and Drive**.

View traffic events on the map

During drive navigation, select **Options > Traffic info**. The events are displayed as triangles and lines.

Update traffic information

Select **Options > Traffic info > Update traffic info**.

When planning a route, you can set the device to avoid traffic events, such as traffic jams or roadworks.

Avoid traffic events

In the main view, select  > **Navigation** > **Reroute due to traffic**.

The location of speed cameras may be shown on your route during navigation, if this feature is enabled. Some jurisdictions prohibit or regulate the use of speed camera location data. Nokia is not responsible for the accuracy, or the consequences of using speed camera location data.

Walk to your destination

When you need directions to follow a route on foot, Maps guides you over squares, and through parks, pedestrian zones, and even shopping centers.

Select **Menu** > **Maps and Walk**.

Walk to a destination

Select **Set destination** and the appropriate option.

Walk to your home

Select **Walk home**.

You can start walking without a set destination.

By default, the map is oriented to north.

Rotate the map to your walking direction

Select . To rotate the map back to north, select .

When you select **Drive home** or **Walk home** for the first time, you are prompted to define your home location.

Change your home location

- 1 In the main view, select .
- 2 Select **Navigation** > **Home Location** > **Redefine**.
- 3 Select the appropriate option.

Plan a route

Plan your journey, and create your route and view it on the map before setting off.

Select **Menu** > **Maps and My position**.

Create a route

- 1 Tap the location of your starting point. To search for an address or place, select **Search**.
- 2 Tap the location's information area.
- 3 Select **Add to route**.
- 4 To add another route point, select **Add new route point** and the appropriate option.

Change the order of the route points

- 1 Select a route point.
- 2 Select **Move**.
- 3 Tap the place where you want to move the route point to.

Edit the location of a route point

Tap the route point, and select **Edit** and the appropriate option.

View the route on the map

Select **Show route**.

Navigate to the destination

Select **Show route** > **Options** > **Start driving** or **Start walking**.

Change the settings for a route

The route settings affect the navigation guidance and the way the route is displayed on the map.

- 1 In the route planner view, open the **Settings** tab. To get to the route planner view from the navigation view, select **Options** > **Route points** or **Route points list**.
- 2 Set the transportation mode to **Drive** or **Walk**. If you select **Walk**, one-way streets are regarded as normal streets, and walkways and routes through, for example, parks and shopping centers, can be used.
- 3 Select the desired option.

Select the walking mode

Open the **Settings** tab, set the transportation mode to **Walk**, and select **Preferred route** > **Streets** or **Straight line**. **Straight line** is useful on off-road terrain as it indicates the walking direction.

Use the faster or shorter driving route

Open the Settings tab, set the transportation mode to **Drive**, and select **Route selection** > **Faster route** or **Shorter route**.

Use the optimized driving route

Open the Settings tab, set the transportation mode to **Drive**, and select **Route selection** > **Optimised**. The optimized driving route combines the advantages of both the shorter and the faster routes.

You can also choose to allow or avoid using, for example, highways, toll roads, or ferries.

Connectivity

Your device offers several options to connect to the internet or to another compatible device or PC.

Data connections and access points

Your device supports packet data connections (network service), such as GPRS in the GSM network. When you use your device in GSM and 3G networks, multiple data connections can be active at the same time, and access points can share a data connection. In 3G networks, data connections remain active during voice calls.

You can also use a Wi-Fi/WLAN data connection. Only one connection in one wireless LAN can be active at a time, but several applications can use the same internet access point.

To establish a data connection, an access point is required. You can define different kinds of access points, such as the following:

- MMS access point to send and receive multimedia messages
- Internet access point (IAP) to send and receive e-mail and connect to the internet

Check the type of access point you need with your service provider for the service you want to access. For availability and subscription to packet data connection services, contact your service provider.

Network settings

Select **Menu** > **Settings and Connectivity** > **Network**.

Your device can automatically switch between GSM and UMTS networks. GSM networks are indicated with **G**. UMTS networks are indicated with **3G**.

Select from the following:

Network mode — Select which network to use. If you select **Dual mode**, the device uses the GSM or UMTS network automatically, according to the network parameters and the roaming agreements between the wireless service providers. For details and roaming costs, contact your network service provider. This option is shown only if supported by the wireless service provider.

A roaming agreement is an agreement between two or more service providers to enable the users of one service provider to use the services of other service providers.

Operator selection — Select **Automatic** to set the device to search for and select one of the available networks, or **Manual** to manually select the network from a list. If the connection to the manually selected network is lost, the device sounds an error tone and asks you to reselect a network. The selected network must have a roaming agreement with your home network.

Cell info display — Set the device to indicate when it is used in a cellular network based on microcellular network (MCN) technology and to activate cell info reception.

Wi-Fi/WLAN connection

Your device can detect and connect to wireless local area networks (WLAN). Using a WLAN, you can connect your device to the internet and compatible devices that have WLAN support.

About Wi-Fi

To use a Wi-Fi connection, it must be available in the location, and your device must be connected to the Wi-Fi. Some Wi-Fi networks are protected, and you need an access key from the service provider to connect to them.

 **Note:** Using Wi-Fi may be restricted in some countries. For example, in France, you are only allowed to use Wi-Fi indoors. For more information, contact your local authorities.

Features that use Wi-Fi, or that are allowed to run in the background while using other features, increase the demand on battery power and reduce the battery life.

Your device supports the following Wi-Fi features:

- IEEE 802.11b/g and WAPI standards
- Operation at 2.4 GHz
- Wired equivalent privacy (WEP) with keys up to 128 bits, Wi-Fi protected access (WPA), and 802.1x authentication methods. These functions can be used only if they are supported by the network.



Important: Use encryption to increase the security of your WLAN connection. Using encryption reduces the risk of others accessing your data.

WLAN connections

To use a wireless LAN (WLAN) connection, you must create an internet access point (IAP) for WLAN. Use the access point for applications that need to connect to the internet.

A WLAN connection is established when you create a data connection using a WLAN internet access point. The active WLAN connection ends when you end the data connection.

You can use WLAN during a voice call or when packet data is active. You can only be connected to one WLAN access point device at a time, but several applications can use the same internet access point.

When the device is in the offline profile, you can still use WLAN (if available). Remember to comply with any applicable safety requirements when establishing and using a WLAN connection.

Tip: To check the unique media access control (MAC) address that identifies your device, open the dialer and enter ***#62209526#**.

Wi-Fi/WLAN wizard

Select **Menu > Settings and Connectivity > Wireless LAN**.

The Wi-Fi/ WLAN wizard helps you to connect to a wireless LAN (WLAN) and manage your Wi-Fi/ WLAN connections.

If the search finds Wi-Fi networks, to create an internet access point (IAP) for a connection and start the web browser using this IAP, select the connection, and from the pop-up menu, select **Start web browsing**.

If you select a secured WLAN, you are asked to enter the relevant password. To connect to a hidden network, you must enter the correct network name (service set identifier, SSID).

If you already have the web browser running using the currently active Wi-Fi/ WLAN connection, to return to the web browser, select **Continue web browsing**.

To end the active connection, select the connection, and from the pop-up menu, select **Disconnect WLAN**.

WLAN internet access points

Select **Menu > Settings and Connectivity > Wireless LAN**.

Filter out Wi-Fi networks from the list of found networks

Select **Options** > **Filter WLAN networks**. The selected networks are not displayed the next time the Wi-Fi wizard searches for Wi-Fi networks.

View the details of a network

Select the network, and from the pop-up menu, select **Details**. If you select an active connection, the connection details are displayed.

Operating modes

There are two operating modes in Wi-Fi WLAN: infrastructure and ad hoc.

The infrastructure operating mode allows two kinds of communication: wireless devices are connected to each other through a Wi-Fi/WLAN access point device, or wireless devices are connected to a wired LAN through a Wi-Fi/WLAN access point device.

In the ad hoc operating mode, devices can send and receive data directly with each other.

Wireless LAN settings

In the wireless LAN (Wi-Fi) settings, you can define whether the Wi-Fi indicator is displayed when a network is available and how often the network is scanned. You can also define whether and how the internet connectivity test is performed, and view advanced Wi-Fi settings.

Select **Menu** > **Settings and Connectivity** > **Wireless LAN** > **Options** > **Settings**.

Display when a Wi-Fi is available

Select **Show WLAN availability** > **Yes**.

Set how often the device searches for available Wi-Fi

Select **Show WLAN availability** > **Yes** and **Scan for networks**.

Define internet capability test settings

Select **Internet connectivity test** and whether to run the test automatically or after confirmation, or to never run the test. If the connectivity test is successful, the access point is saved to the internet destinations list.

View advanced settings

Select **Options** > **Advanced settings**.

It is recommended that you do not modify the advanced Wi-Fi settings.





Access points**Create a new access point**

Select **Menu** > **Settings and Connectivity** > **Destinations**.



You may receive access point settings in a message from a service provider. Some or all access points may be preset for your device by your service provider, and you may not be able to change, create, edit, or remove them.

- 1 Select  **Access point**.
- 2 The device asks you to check for available connections. After the search, connections that are already available are shown and can be shared by a new access point. If you skip this step, you are asked to select a connection method and to define the settings needed.

To view access points stored in your device, select an access point group. The different access point groups are the following:

-  Internet access points
-  Multimedia messaging access points
-  WAP access points
-  Uncategorized access points

The different access point group types are the following:

-  Protected access point
-  Packet data access point
-  Wireless LAN (Wi-Fi) access point

Manage access point groups

To avoid selecting a single access point every time the device makes a network connection, you can create a group that contains various access points to connect to that network and define the order in which the access points are used. For example, you can add Wi-Fi and packet data access points to an internet access point group, and use the group for browsing the web. If you give Wi-Fi the highest priority, the device connects to the internet through Wi-Fi, if available, and through a packet data connection if not.

Select **Menu** > **Settings and Connectivity** > **Destinations**.

Create a new access point group

Select **Options** > **New destination**.

Add access points to an access point group

Select the group and **Options** > **New access point**.

Copy an existing access point from another group

Select the group, and select and hold the access point to copy, and from the pop-up menu, select **Copy to other dest..**

Change the priority of an access point within a group

Select and hold the access point, and from the pop-up menu, select **Change priority.**

GPRS access point settings

Select **Menu > Settings and Connectivity > Destinations > Access point**, and follow the instructions.

Edit a GPRS access point

Select an access point group and access point marked with . Follow the instructions from your service provider.

Select from the following:

Access point name — The access point name is provided by your service provider.

User name — The user name may be needed to make a data connection, and is usually provided by your service provider.

Prompt password — If you must enter the password every time you log in to a server, or if you do not want to save your password in the device, select **Yes**.

Password — A password may be needed to make a data connection and is usually provided by your service provider.

Authentication — To always send your password encrypted, select **Secure**. To send your password encrypted when possible, select **Normal**.

Homepage — Depending on the access point you are setting up, enter the web address or the address of the multimedia message center.

Use access point — Set the device to connect to the destination using this access point after confirmation or automatically.

Modify advanced GPRS access point settings

Select **Options > Advanced settings**.

Select from the following:

Network type — Select the internet protocol type to transfer data to and from your device. The other settings depend on the selected network type.

Phone IP address (for IPv4 only) — Enter the IP address of your device.

DNS addresses — Enter the IP addresses of the primary and secondary DNS servers, if required by your service provider. To obtain these addresses, contact your internet service provider.

Proxy server address — Enter the address of the proxy server.

Proxy port number — Enter the port number of the proxy server.

Wi-Fi access point settings

Select **Menu > Settings and Connectivity > Destinations > Access point**, and follow the instructions.

Edit a wireless LAN (Wi-Fi) access point

Select an access point group and access point marked with . Follow the instructions from your WLAN service provider.

Select from the following:

WLAN network name — Select **Enter manually** or **Search for networks**. If you select an existing network, the Wi-Fi network mode and Wi-Fi security mode are determined by the settings of its access point device.

Network status — Define whether the network name is displayed.

WLAN network mode — Select **Ad-hoc** to create an ad hoc network and to allow devices to send and receive data directly; a WLAN access point device is not needed. In an ad hoc network, all devices must use the same WLAN network name.

WLAN security mode — Select the encryption used: **WEP**, **802.1x**, or **WPA/WPA2** (802.1x and WPA/WPA2 are not available for ad hoc networks). If you select **Open network**, no encryption is used. The WEP, 802.1x, and WPA functions can be used only if the network supports them.

Homepage — Enter the web address of the starting page.

Use access point — Set the device to create a connection using this access point automatically or after confirmation.



The available options may vary.

Close a network connection

If several applications are using an internet connection, you can use the Connection manager application to close some or all network connections.

Select **Menu > Settings and Connectivity > Connection mgr..**

In the active data connections view, you can see your current network connections.

 indicates a packet data connection, and  indicates a Wi-Fi connection.

View details for a connection

Select and hold the connection, and from the pop-up menu, select **Details**.

Details, such as the amount of transferred data and connection duration, are displayed.

Close a connection

Select and hold the connection, and from the pop-up menu, select **Disconnect**.

Synchronization

With the Sync application, you can synchronize your notes, messages, contacts, and other information with a remote server.

Select **Menu > Settings > Connectivity > Data transfer**.

You may receive synchronization settings as a configuration message from your service provider.

A synchronization profile contains the necessary settings for synchronization. When you open the application, the default or previously used synchronization profile is displayed.

Include or exclude content types

Select a content type.

Synchronize data

Select **Options > Synchronise**.

Create a new synchronization profile

Select **Options > New sync profile**.

Manage synchronization profiles

Select **Options** and the desired option.

Synchronize data with Ovi Sync

Select **Menu > Applications > Tools > Ovi sync**.

When you open the application for the first time, the synchronization wizard helps you define the settings and select the content to synchronize.

Select from the following:

Sync settings — Define the synchronization settings.

Retrieve backup — Restore contacts, calendar entries, and notes to your device from Ovi. Updates performed since the previous sync are preserved.

Unsubscribe Ovi sync — Deactivate Ovi sync.

The available options may vary.

Bluetooth connectivity

About Bluetooth connectivity

With Bluetooth connectivity, you can make a wireless connection to other compatible devices, such as mobile phones, computers, headsets, and car kits.

You can use the connection to send items from your device, transfer files from your compatible PC, and print files with a compatible printer.



Select **Menu** > **Settings and Connectivity** > **Bluetooth**.

Since devices with Bluetooth wireless technology communicate using radio waves, they do not need to be in direct line-of-sight. However, they must be within 10 meters (33 feet) of each other, although the connection may be subject to interference from obstructions such as walls or from other electronic devices.

This device is compliant with Bluetooth Specification 2.0 + EDR supporting the following profiles: Advanced Audio Distribution, Audio/Video Remote Control, Basic Imaging, Basic Printing, Device ID, Dial-up Networking, File Transfer, Generic Audio/Video Distribution, Generic Access, Generic Object Exchange, Handsfree, (Human Interface Device) Headset, Object Push, Phone Book Access, Serial Port, and SIM Access. To ensure interoperability between other devices supporting Bluetooth technology, use Nokia approved accessories for this model. Check with the manufacturers of other devices to determine their compatibility with this device.

When the device is locked, only connections to authorized devices are possible.

Bluetooth settings

Select **Menu** > **Settings and Connectivity** > **Bluetooth**.

Select from the following:

Bluetooth — Activate Bluetooth connectivity.

My phone's visibility — To allow your device to be visible to other Bluetooth devices, select **Shown to all**. To set a length of time, after which the visibility is set from shown to hidden, select **Set visibility period**. To hide your device from other devices, select **Hidden**.

My phone's name — Edit the name of your device. The name is shown to other Bluetooth devices.

Remote SIM mode — Allow another device, such as a compatible car kit accessory, to use the SIM card in your device to connect to the network.

Security tips

Select **Menu > Settings and Connectivity > Bluetooth**.

When you are not using Bluetooth connectivity, to control who can find your device and connect to it, select **Bluetooth > Off** or **My phone's visibility > Hidden**. Deactivating the Bluetooth function does not affect other functions in your device.





Do not pair with or accept connection requests from an unknown device. This helps to protect your device from harmful content. Operating the device in hidden mode is a safer way to avoid malicious software.

Send data using Bluetooth connectivity

You can have several Bluetooth connections active at a time. For example, if you are connected to a compatible headset, you can also transfer files to another compatible device.

- 1 Open the application where the item you want to send is stored.
- 2 Go to an item, and select **Options > Send > Via Bluetooth**.

Devices with Bluetooth wireless technology that are within range are displayed. Device icons are as follows:

	computer
	phone
	audio or video device
	other device

To interrupt the search, select **Cancel**.

- 3 Select the device with which you want to connect.
- 4 If the other device requires pairing before data can be transmitted, a tone sounds, and you are asked to enter a passcode. The same passcode must be entered in both devices.

When the connection is established, **Sending data** is displayed.

Tip: When searching for devices, some devices may show only the unique address (device address). To find the unique address of your device, in the dialer, enter ***#2820#**.

Pair devices

You can pair your device with a compatible device to make subsequent Bluetooth connections between the devices quicker. Before pairing, create your own passcode (1 to 16 digits), and agree with the owner of the other device to use the same code. Devices that do not have a user interface have a factory-set passcode. The passcode is used only once.

Select **Menu** > **Settings and Connectivity** > **Bluetooth**.

- 1 Open the Paired devices tab.
- 2 Select **Options** > **New paired device**. Devices that are within range are displayed.
- 3 Select the device.
- 4 Enter the passcode on both devices.

⌘ indicates a paired device in the device search view.

Connect to an accessory after pairing

Select the audio device, and from the pop-up menu, select **Connect to audio device**. Some audio accessories connect automatically to your device after pairing.

Set a device as authorized

Select **Set as authorised**. Connections between your device and the authorized device can be made without your knowledge. Use this only for your own devices, such as your compatible headset or PC, or devices that belong to someone you trust.  indicates authorized devices in the paired devices view.



Cancel a pairing with a device

Select the device, and from the pop-up menu, select **Delete**.

Cancel all pairings

Select **Options** > **Delete all**.

Receive data using Bluetooth connectivity

When you receive data using Bluetooth connectivity, a tone sounds, and the device asks you if you want to accept the message. If you accept,  is displayed, and you can find an informative message about the data in the Inbox folder in Messaging. Messages received using Bluetooth connectivity are indicated with .

Block a device

You can prevent devices from creating a Bluetooth connection to your device.

Select **Menu** > **Settings and Connectivity** > **Bluetooth**.

Open the Paired devices tab, select and hold the device you want to block, and from the pop-up menu, select **Block**.

Remove a device from the blocked devices list

Open the Blocked devices tab, select and hold the device you want to remove from the list, and from the pop-up menu, select **Delete**.

If you reject a pairing request from another device, you are asked if you want to add the device to the list of blocked devices.

Remote SIM mode

With remote SIM mode, you can use a compatible car kit accessory. Before remote SIM mode can be activated, the two devices must be paired and the pairing initiated from the other device. When pairing, use a 16-digit passcode, and set the other device as authorized.

Select **Menu > Settings and Connectivity > Bluetooth.**

Activate remote SIM mode

- 1 Activate Bluetooth connectivity. Select **Bluetooth.**
- 2 Activate remote SIM mode in your device. Select **Remote SIM mode.**
- 3 Activate remote SIM mode in the other device.

When remote SIM mode is activated, **Remote SIM mode** is displayed in the home screen. The connection to the wireless network is closed, and you cannot use SIM card services or features that require cellular network coverage.

When your device is in remote SIM mode, you can only make or receive calls using the connected accessory. Your device can only make calls to the emergency numbers programmed into your device.

Deactivate remote SIM mode

Press the power key, and select **Exit remote SIM mode.**

Transfer data using a USB cable



Select **Menu > Settings and Connectivity > USB.**

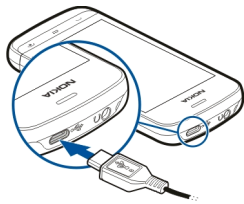

Select the USB mode every time a compatible data cable is connected

Select **Ask on connection > Yes.**

If the **Ask on connection** option is not active, or you want to change the USB mode during an active connection, select **USB connection mode** and from the following:

Ovi Suite — Use Nokia PC applications such as Nokia Ovi Suite or Nokia Software Updater.

Mass storage — Transfer data between your device and a compatible PC.

Image transfer — Print images using a compatible printer.

Media transfer — Synchronize music with Nokia Music or Windows Media Player.

PC connections

You can use your mobile device with a variety of compatible PC connectivity and data communications applications. With Nokia Ovi Suite you can, for example, transfer files and images between your device and a compatible computer.

To use Ovi Suite with USB connection mode, select **Ovi Suite**.

For more information about Ovi Suite, see the support area at www.ovi.com.

Administrative settings

Packet data settings

Select **Menu > Settings and Connectivity > Admin. settings > Packet data**.

The packet data settings affect all access points using a packet data connection.

Open a GPRS connection whenever the network is available

Select **Packet data connection > When available**.

It is quicker, for example, to send an e-mail, if the connection is always open. If there is no network coverage, the device periodically tries to open a GPRS connection.

Open a GPRS connection only when needed

Select **Packet data connection > When needed**.

Every time you, for example, send an e-mail, the connection needs to be opened first.

Use HSDPA (network service) in UMTS networks

Select **High speed packet access**.

You can use your device as a modem for your computer, to access the internet over a GPRS connection.

Define the access point to use when using your device as a modem

Select **Access point**.

SIP settings

Session Initiation Protocol (SIP) settings are needed for certain network services using SIP. You may receive the settings in a special text message from your service provider. You can view, delete, or create these setting profiles in SIP settings.

Select **Menu > Settings and Connectivity > Admin. settings > SIP settings.**

Access point name control

With the access point name control service, you can restrict packet data connections and allow your device to use only certain packet data access points.

Select **Menu > Settings and Connectivity > Admin. settings > APN control.**

This setting is only available if your SIM card supports the access point control service.

Activate the service, or set the allowed access points

Select **Options** and the appropriate option.

To modify the settings, you need to enter your PIN2 code. The code is provided by your service provider.

Search**About Search**

Select **Menu > Applications > Search.**

With Search you can find people, messages, music, and other content on your device, or search the internet (network service). The content and availability of the services may vary.

Start a search

Select **Menu > Applications > Search.**

To search the contents of your cellular device, enter search terms in the search field, or browse the content categories. While you enter the search terms, the results are organized into categories. The most recently accessed results appear at the top of the result list, if they match your search terms.

To search for web pages on the internet, select **Search the Internet** and a search provider, and enter your search terms in the search field. The search provider you selected is set as your default internet search provider.

If a default search provider is already set, select it to start a search, or select **More search services** to use another search provider.

To change the default search provider, select **Options > Settings > Search services**.

To change the country or region setting, to find more search providers, select **Options > Settings > Country or region**.

Other applications

Clock

Set time and date

Select **Menu > Applications > Clock**.

Select **Options > Settings** and from the following:

Time — Set the time.

Date — Set the date.

Automatic time update — Set the network to automatically update the time, date, and time zone information for your device (network service).



Alarm clock

Select **Menu > Applications > Clock**.

Set a new alarm

- 1 Select **New alarm**.
- 2 Set the alarm time.
- 3 Select **Repeat** to set whether and when the alarm is repeated.
- 4 Select **Done**.

View your alarms

Select **Alarms**.  indicates an active alarm.  indicates a repeated alarm.

Remove an alarm

Select **Alarms** and the alarm, and from the pop-up menu, select **Remove alarm**.

Stop the alarm

Select **Stop**. If your device is switched off when an alarm expires, your device switches itself on and starts sounding the alarm tone.

Set the alarm to snooze

Select **Snooze**.

Define the snooze time

Select **Options > Settings > Alarm snooze time**.

Change the alarm tone

Select **Options** > **Settings** > **Clock alarm tone**.

World clock

With the world clock, you can view the current time in different locations.

Select **Menu** > **Applications** > **Clock**.

View the time

Select **World clock**.

Add locations to the list

Select **Options** > **Add location**.

Set your current location

Select the location, and from the pop-up menu, select **Set as current location**. The time in your device is changed according to the selected location. Ensure that the time is correct and matches your time zone.

Calendar

To open the calendar, select **Menu** > **Calendar**.

Calendar views

To switch between the month, week, day, and to-do note views, select **Options** > **Change view** and the desired view.

To change the starting day of the week or the view that is displayed when you open the calendar, or to modify calendar alarm settings, select **Options** > **Settings**.

To go to a certain date, select **Options** > **Go to date**.

Calendar toolbar

Select **Menu** > **Calendar**.

From the calendar toolbar, select from the following:

 **Next view** — Select the month view.

 **Next view** — Select the week view.

 **Next view** — Select the day view.

 **Next view** — Select the to-do view.

 **New meeting** — Add a new meeting reminder.

 **New to-do note** — Create a new to-do entry.

File manager

About File manager

Select **Menu** > **Applications** > **Office** > **File mgr..**

With File manager, you can browse, manage, and open files on your device or a compatible external drive.

Find and organize files

Select **Menu** > **Applications** > **Office** > **File mgr..**

Search for a file

Select **Options** > **Find**. Enter search text that matches the file name.

Move and copy files and folders

Select **Options** > **Organise** and the desired option.

Sort files

Select **Options** > **Sort by** and the desired category.

Edit the memory card

You can format a memory card to erase the data on it, or you can protect the data on the memory card with a password.

Select **Menu** > **Applications** > **Office** > **File mgr..**

Rename or format a memory card

Select the memory card, **Options** > **Memory card options**, and the desired option.

Password protect a memory card

Select the memory card and **Options** > **Memory card password**.

These options are available only if a compatible memory card is inserted in the device.

Back up files

Select **Menu** > **Applications** > **Office** > **File mgr.** and **Backup**.

It is recommended that you back up the device memory regularly to a compatible computer or memory card.

Tip: If you have DRM-protected content, use Nokia PC Suite to back up both the licenses and the content to your computer.

Application manager

About Application manager

Select **Menu** > **Settings and Application mgr.**.

With Application manager you can view details of installed applications, remove applications, and define installation settings.

You can install the following types of applications:

- J2ME applications, based on Java™ technology, that have the .jad or .jar file extension
- Applications, compatible with the Symbian operating system, that have the .sis or .sisx file extension
- Widgets that have the .wgz file extension

Only install applications that are compatible with your device.

Install applications

You can transfer installation files to your device from a compatible computer, download them during browsing, or receive them in a multimedia message, as an e-mail attachment, or using other connectivity methods, such as Bluetooth connectivity.

You can use Nokia Application Installer in Nokia Ovi Suite to install an application to your device.

Select **Menu** > **Settings and Application mgr.**.

The installation files are located in the Installation files folder, and the installed applications in the Installed apps. folder.

Icons indicate the following:



SIS or SISX application



Java application



Widget



Application installed on the memory card

Before installing an application, check the following:

- View the application type, version number, and the supplier or manufacturer of the application. Select the application.
- View the security certificate details of the application. Select **Certificates: > View details**.

If you install a file that contains an update or repair to an existing application, you can only restore the original application if you have the original installation file or a full backup copy of the removed software package. To restore the original application, remove the application, and install the application again from the original installation file or the backup copy.

The JAR file is required for installing Java applications. If it is missing, the device may ask you to download it. If there is no access point defined for the application, you are asked to select one.

Install an application

- 1 Locate the installation file in the Installation files folder in Application manager, or search for it in File manager or your Inbox in Messaging.
- 2 In Application manager, select and hold the application you want to install, and from the pop-up menu, select **Install**. In other applications, select the installation file to start the installation.

During installation, the device shows information about the progress of the installation. If you install an application without a digital signature or certification, the device displays a warning. Continue installation only if you are sure of the origin and contents of the application.

Open an installed application

Select the application in the menu. If the application does not have a default folder defined, it is installed in the Installed apps. folder in the main menu.

See which software packages are installed or removed

Select **Options > View log**.

Remove an application from your device

You can remove installed applications that you no longer need or use, to increase the amount of available memory.

Select **Menu > Settings and Application mgr..**

- 1 Select **Installed apps..**
- 2 Select and hold the application to remove, and from the pop-up menu, select **Uninstall**.

If you remove an application, you can only reinstall it if you have the original installation file or a full backup of the removed application. You may not be able to open files created with a removed application.

If an installed application depends on a removed application, the installed application may stop working. For details, see the user documentation of the installed application.

After you install applications to a compatible memory card, installation files (.sis, .sisx) remain in the device memory. The files may use large amounts of memory and prevent you from storing other files. To maintain sufficient memory, use Nokia Ovi Suite to back up installation files to a compatible PC, then use the file manager to remove the installation files from the device memory. If the .sis file is a message attachment, delete the message from the Messaging inbox.

Application manager settings

Select **Menu > Settings and Application mgr..**

Select **Installation settings** and from the following:

Software installation — Allow or deny installation of Symbian software that does not have a verified digital signature.

Online certificate check — Check online certificates before installing an application.

Default web address — Set the default web address used to check online certificates.

RealPlayer

With RealPlayer, you can play video clips or stream media files over the air without saving them to the device first.

RealPlayer does not necessarily support all file formats or all the variations of file formats.

Select **Menu > Applications > RealPlayer.**

RealPlayer toolbar

Select **Menu > Applications > RealPlayer.**

In the Video clips, Streaming links, and Recently played views, the following toolbar icons may be available:

 **Send** — Send a video clip or streaming link.

 **Play** — Play a video or video stream.

 **Delete** — Delete a video or streaming link.

 **Remove** — Remove a file from the recently played list.

Play a video

Select **Menu > Applications > RealPlayer**.

Play a video

Select **Video clips** and a video.

List recently played files

In the main view, select **Recently played**.

Go to a video, and select **Options** and from the following:

Use video clip — Assign a video to a contact or set it as a ringing tone.

Mark/Unmark — Mark or unmark an item, to send or delete multiple items at the same time.

View details — View details, such as format, resolution, and duration.

Settings — Edit settings for video playback and streaming.

Stream content over the air

Select **Menu > Applications > RealPlayer**.

Streaming content over the air is a network service. Select **Streaming links** and a link. You can also receive a streaming link in a text or multimedia message, or open a link on a web page.

Before live content begins streaming, your device connects to the site and starts loading the content. The content is not saved in your device.

In RealPlayer, you can only open RTSP links. However, RealPlayer can also play a RAM file if you open a HTTP link to it in a browser.

Recorder

You can use the recorder to record voice memos and telephone conversations. You can also send sound clips to your friends.

Select **Menu > Applications > Office > Recorder**.

Record a sound clip

Select .

Stop recording a sound clip

Select .

Listen to the sound clip

Select .

Send a sound clip as a message

Select **Options** > **Send**.

Record a telephone conversation

Open the recorder during a voice call, and select . Both parties hear a tone at regular intervals during recording.

Select the recording quality or where to save sound clips

Select **Options** > **Settings**.

You cannot use the recorder during a data call or when a GPRS connection is open.

Write a note

- 1 Select **Menu** > **Applications** > **Office** > **Notes**.
- 2 Select **Options** > **New note**.
- 3 Enter text in the note field.
- 4 Select .

Make a calculation

- 1 Select **Menu** > **Applications** > **Office** > **Calculator**.
- 2 Enter the first number of the calculation.
- 3 Select a function, such as add or subtract.
- 4 Enter the second number of the calculation.
- 5 Select **=**.

Converter

With Converter, you can convert measures from one unit to another.

The converter has limited accuracy, and rounding errors may occur.

Select **Menu** > **Applications** > **Office** > **Converter**.

Dictionary

Select **Menu** > **Applications** > **Office** > **Dictionary**.

To translate words from one language to another, enter text in the search field. As you enter text, suggestions of words to translate are displayed. To translate a word, select the word from the list.

All languages may not be supported.

Select **Options** and from the following:

Listen — Listen to the selected word.

History — Find previously translated words from the current session.

Languages — Change the source or target language, download languages from the internet, or remove a language from the dictionary. You cannot remove the English language from the dictionary. You can have two additional languages installed, besides English.

Settings

Some settings may be preset for the device by your service provider, and you may not be able to change them.

Phone settings

Date and time settings

Select **Menu** > **Settings** and **Phone** > **Date and time**.

Select from the following:

Time — Enter the current time.

Time zone — Select your location.

Date — Enter the current date.

Date format — Select the date format.

Date separator — Select the symbol that separates days, months, and years.

Time format — Select the time format.

Time separator — Select the symbol that separates hours and minutes.

Clock type — Select the clock type.

Clock alarm tone — Select the tone for the alarm clock.

Alarm snooze time — Adjust the snooze time.

Workdays — Select your working days. You can then set an alarm only for working day mornings, for example.

Automatic time update — Set the device to update the time, date, and time zone automatically. This network service may not be available on all networks.

Change language

You can change the device language and the language in which you write your messages and mails. You can also activate predictive text input.

Select **Menu** > **Settings and Phone** > **Language**.

Change the device language

Select **Phone language**.

Change the writing language

Select **Writing language**.

Activate predictive text input

Select **Predictive text**.

Display settings

Select **Menu** > **Settings and Phone** > **Display**.

Select from the following:

Brightness — Adjust the brightness of your device display.

Font size — Select the size of text and icons on the display.

Welcome note / logo — Set a note or image to be displayed when you switch on the device.

Light time-out — Set how long the light stays on when you stop using the device.

Voice commands

Activate voice commands

Press and hold the call key in the home screen, and say a command. The voice command is the name of the application or profile displayed in the list.

To view the list of voice commands, select **Menu** > **Settings and Phone** > **Voice commands**.

Select **Options** and from the following:

Settings — Adjust the settings.

Voice command tutorial — Open the tutorial for voice commands.

Change or play a command

Select and hold the command, and from the pop-up menu, select **Change command** or **Playback**.

Delete a command

Select and hold the application or profile the command is assigned to, and from the pop-up menu, select **Remove**.

Accessory settings

Select **Menu > Settings and Phone > Accessories**.

Some accessory connectors indicate which type of accessory is connected to the device.

Select an accessory and from the following:

Default profile — Set the profile that you want activated each time you connect a certain compatible accessory to your device.

Automatic answer — Set the device to answer an incoming call automatically after 5 seconds. If the ringing type is set to **Beep once** or **Silent**, automatic answer is disabled.

Lights — Set the lights to remain on after the time-out.

The available settings depend on the type of accessory.

Application settings

Select **Menu > Settings and Phone > Application sett..**

In application settings, you can edit the settings of some of the applications in your device.

To edit the settings, you can also select **Options > Settings** in each application.

Device updates

With Device updates, you can connect to a server and receive configuration settings for your device, create new server profiles, view existing software version and device information, or view and manage existing server profiles.

Select **Menu > Settings and Phone > Phone mgmt. > Device updates**.

You may receive server profiles and different configuration settings from your service providers and company information management department. These configuration settings may include connection and other settings used by different applications in your device.

Receive configuration settings

- 1 Select **Options > Server profiles**.
- 2 Select and hold the profile, and from the pop-up menu, select **Start configuration**.

Create a server profile

Select **Options > Server profiles > Options > New server profile**.

Delete a server profile

Select and hold the profile, and from the pop-up menu, select **Delete**.

Security settings

Phone and SIM

Select **Menu > Settings and Phone > Phone mgmt. > Security > Phone and SIM card**.

Select from the following:

PIN code request — When active, the code is requested each time the device is switched on. Deactivating the PIN code request may not be allowed by some SIM cards.

PIN code and **PIN2 code** — Change the PIN and PIN2 code. These codes can only include numbers. Avoid using access codes similar to the emergency numbers to prevent accidental dialing of the emergency number. If you forget the PIN or PIN2 code, contact your service provider. If you forget the lock code, contact a Nokia Care point or your service provider.

Lock code — The lock code is used to unlock the device. To avoid unauthorised use of your device, change the lock code. The preset code is 12345. The new code can be 4-255 characters long. Alphanumeric characters and both uppercase and lowercase characters can be used. The device notifies you if the lock code is not properly formatted. Keep the new code secret and separate from your device.

Phone autolock period — To avoid unauthorized use, you can set a time-out after which the device automatically locks. A locked device cannot be used until the correct lock code is entered. To turn off autolock, select **None**.

Lock if SIM card changed — Set the device to ask for the lock code when an unknown SIM card is inserted into your device. The device maintains a list of SIM cards that are recognized as the owner's cards.

Remote phone locking — Enable or disable remote lock.

Closed user group — Specify a group of people to whom you can call and who can call you (network service).

Confirm SIM services — Set the device to display confirmation messages when you are using a SIM card service (network service).

Manage certificates

Digital certificates protect your content when transferring confidential information. Certificates should be used when connecting to an online bank or another site, or to a remote server for actions that involve transferring confidential information.

Certificates should also be used when you want to reduce the risk of viruses or other malicious software and be sure of the authenticity of software when downloading and installing software.

Select **Menu** > **Settings and Phone** > **Phone mgmt.** > **Security** > **Certificate management** and select the desired certificate type.

Digital certificates do not guarantee safety; they are used to verify the origin of software.



Important: The existence of a certificate considerably reduces risks involved in remote connections and software installation. To benefit from increased security, certificates must be used correctly, and they must be correct, authentic, or trusted. Certificates have a restricted lifetime. If they are expired or invalid, check that the current date and time in your device are correct.

Security module

The security module provides security services for different applications.

Select **Menu** > **Settings and Phone** > **Phone mgmt.** > **Security** > **Security module** and the desired security module.

View security module details

Select **Options** > **Security details**.

Restore original settings

You can reset some of the settings to their original values. All active calls and connections must be ended.

Select **Menu** > **Settings and Phone** > **Phone mgmt.** > **Factory settings**. To restore the settings, you need to enter the lock code.

After resetting, the device may take a longer time to power on. Documents and files are unaffected.

Protected content

Digital rights management (DRM) protected content, for example some media files, such as images, music, or videos, comes with an associated license that defines your rights to use the content.

You can view the details and status of the licenses, and reactivate and remove licenses.

Manage digital rights licenses.

Select **Menu** > **Settings** > **Phone** > **Phone mgmt.** > **Security** > **Protected content**.

Digital rights management

Content owners may use different types of digital rights management (DRM) technologies to protect their intellectual property, including copyrights. This device uses various types of DRM software to access DRM-protected content. With this device you can access content protected with WMDRM 10, OMA DRM 1.0, and OMA DRM 2.0. If certain DRM software fails to protect the content, content owners may ask that such DRM software's ability to access new DRM-protected content be revoked. Revocation may also prevent renewal of such DRM-protected content already in your device. Revocation of such DRM software does not affect the use of content protected with other types of DRM or the use of non-DRM-protected content.

Notification lights

Select **Menu > Settings and Phone > Notification lights.**

To turn the standby breathing light on or off, select **Standby br. light.**

When the standby breathing light is turned on, the menu key lights up periodically.

To turn the notification light on or off, select **Notification light.**

When the notification light is turned on, the menu key lights up for a period you define to notify of missed events, such as missed calls or unread messages.

Call settings

Call settings

With call settings, you can define call specific settings in your device.

Select **Menu > Settings and Calling > Call.**

Select from the following:

Send my caller ID — Select **Yes** to show your phone number to the person you are calling. To use the setting agreed upon with your service provider, select **Set by network** (network service).

Send my internet call ID — Select **Yes** to show your internet call ID to the person you are calling.

Call waiting — Set your device to notify you of incoming calls while you are in a call (network service), or check whether the feature is activated.

Internet call waiting — Set your device to notify you of a new incoming internet call while you are in a call.

Internet call alert — To set your device to alert for incoming internet calls, select **On**. If you select **Off**, you receive only a notification if you missed a call.

Reject call with message — Send a text message when you reject a call, informing the caller why you could not answer the call.

Message text — Write the standard text message that is sent when you reject a call.

Automatic redial — Set your device to make a maximum of 10 attempts to connect the call after an unsuccessful call attempt. To stop automatic redialing, press the end key.

Show call duration — Display the length of a call during a call.

Summary after call — Display the length of a call after a call ends.

Speed dialling — Activate 1-touch dialing.

Anykey answer — Activate anykey answer.

The available options may vary.

Call forward

You can forward incoming calls to your voice mailbox or to another phone number. For details, contact your service provider.

Select **Menu** > **Settings and Calling** > **Call divert**.

Forward incoming voice calls to your voice mailbox or to another phone number.

- 1 Select **Voice calls** > **All voice calls**.
- 2 To activate call forwarding, select **Activate**.
- 3 To divert calls to your voice mailbox, select **To voice mailbox**.
- 4 To divert calls to another phone number, select **To other number**, and enter the number, or select **Find** to retrieve a number saved in the contacts list.

Several diverting options can be active at the same time. In the home screen,  indicates that all calls are forwarded.

Call restrictions

With call restriction (network service), you can restrict the calls that you make or receive with the device. For example, you can restrict all outgoing international calls or incoming calls when you are abroad. To edit the settings, you need the restriction password from your service provider.

Select **Menu** > **Settings and Calling** > **Call barring**.

Restrict voice calls or check the restriction status

Select the desired restriction option and **Activate** or **Check status**. Call restriction affects all calls, including data calls.

Restrict anonymous internet calls

Select **Anonymous call barring**.

Protect the environment

Save energy

You do not need to charge your battery so often if you do the following:

- Close applications and data connections, such as Wi-Fi or Bluetooth, when not in use.
- Deactivate unnecessary sounds, such as touch screen and key tones.

Recycle



When this device has reached the end of its working life, all of its materials can be recovered as materials and energy. To guarantee the correct disposal and reuse, Nokia co-operates with its partners through a program called We:recycle. For information on how to recycle your old Nokia products and where to find collection sites, go to www.nokia.com/werecycle, or using a mobile device, nokia.mobi/werecycle, or call the Nokia Contact Center.

Recycle packaging and user guides at your local recycling scheme.

For more information on the environmental attributes of your device, go to www.nokia.com/ecodeclaration.

Product and safety information

Accessories



Warning:

Use only batteries, chargers, and accessories approved by Nokia for use with this particular model. The use of any other types may invalidate any approval or guarantee, and may be dangerous. In particular, use of unapproved chargers or batteries may present a risk of fire, explosion, leakage, or other hazard.

For availability of approved accessories, please check with your dealer. When you disconnect the power cord of any accessory, grasp and pull the plug, not the cord.

Network services and costs

Your device is approved for use on the WCDMA 2100/1900/850 MHz and GSM/EDGE 850/900/1800/1900 MHz networks. To use the device, you need a subscription with a service provider.

Using network services and downloading content to your device may result in data traffic costs. Some product features require support from the network, and you may need to subscribe to them.

Take care of your device

Handle your device, battery, charger and accessories with care. The following suggestions help you protect your warranty coverage.

- Keep the device dry. Precipitation, humidity, and all types of liquids or moisture can contain minerals that corrode electronic circuits. If your device gets wet, remove the battery, and allow the device to dry.
- Do not use or store the device in dusty or dirty areas. Moving parts and electronic components can be damaged.
- Do not store the device in high temperatures. High temperatures can shorten the life of the device, damage the battery, and warp or melt plastics.
- Do not store the device in cold temperatures. When the device warms to its normal temperature, moisture can form inside the device and damage electronic circuits.
- Do not attempt to open the device other than as instructed in the user guide.
- Unauthorized modifications may damage the device and violate regulations governing radio devices.
- Do not drop, knock, or shake the device. Rough handling can break internal circuit boards and mechanics.
- Only use a soft, clean, dry cloth to clean the surface of the device.
- Do not paint the device. Paint can clog the moving parts and prevent proper operation.
- Switch off the device and remove the battery from time to time for optimum performance.
- Keep your device away from magnets or magnetic fields.
- To keep your important data safe, store it in at least two separate places, such as your important device, memory card, or computer, or write down important information.

During extended operation, the device may feel warm. In most cases, this condition is normal. If you suspect the device is not working properly, take it to the nearest authorized service facility.

Recycle

Always return your used electronic products, batteries, and packaging materials to dedicated collection points. This way you help prevent uncontrolled garbage disposal and promote the recycling of materials. Check product environmental information and how to recycle your Nokia products at www.nokia.com/werecycle, or with a cellular phone, [nokia.mobi/werecycle](tel:nokia.mobi/werecycle).

About Digital Rights Management

When using this device, obey all laws and respect local customs, privacy and legitimate rights of others, including copyrights. Copyright protection may prevent you from copying, modifying, or transferring images, music, and other content.

Content owners may use different types of digital rights management (DRM) technologies to protect their intellectual property, including copyrights. This device uses various types of DRM software to access DRM-protected content. With this device you can access content protected with WMDRM 10 and OMA DRM 2.0. If certain DRM software fails to protect the content, content owners may ask that such DRM software's ability to access new DRM-protected content be revoked. Revocation may also prevent renewal of such DRM-protected content already in your device. Revocation of such DRM software does not affect the use of content protected with other types of DRM or the use of non-DRM-protected content.

Digital rights management (DRM) protected content comes with an associated license that defines your rights to use the content.

If your device has OMA DRM-protected content, to back up both the licenses and the content, use the backup feature of Nokia Ovi Suite.

116 Product and safety information

Other transfer methods may not transfer the licenses which need to be restored with the content for you to be able to continue the use of OMA DRM-protected content after the device memory is formatted. You may also need to restore the licenses in case the files on your device get corrupted.

If your device has WMDRM-protected content, both the licenses and the content will be lost if the device memory is formatted. You may also lose the licenses and the content if the files on your device get corrupted. Losing the licenses or the content may limit your ability to use the same content on your device again. For more information, contact your service provider.

Some licenses may be connected to a specific SIM card, and the protected content can be accessed only if the SIM card is inserted in the device.

Batteries and chargers

Battery and charger information

This device is intended for use with a BL-4U rechargeable battery. Nokia may make additional battery models available for this device. Always use original Nokia batteries.

This device is intended for use when supplied with power from the following chargers: AC-8. The exact charger model number may vary depending on the type of plug. The plug variant is identified by one of the following: E, X, AR, U, A, C, K, or B.

The battery can be charged and discharged hundreds of times, but it will eventually wear out. When the talk and standby times are noticeably shorter than normal, you need to replace the battery.

Battery safety

Always switch the device off and disconnect the charger before removing the battery. When you unplug a charger or an accessory, hold and pull the plug, not the cord.

When your charger is not in use, unplug it from the electrical plug and the device. Do not leave a fully charged battery connected to a charger, as overcharging may shorten the battery's lifetime. If left unused, a fully charged battery will lose its charge over time.

Always keep the battery between 15°C and 25°C (59°F and 77°F). Extreme temperatures reduce the capacity and lifetime of the battery. A device with a hot or cold battery may not work temporarily.

Accidental short-circuiting can happen when a metallic object touches the metal strips on the battery, for example, if you carry a spare battery in your pocket. Short-circuiting may damage the battery or the connecting object.

Do not dispose of batteries in a fire as they may explode. Dispose of batteries according to local regulations. Recycle when possible. Do not dispose as household garbage.

Do not dismantle, cut, open, crush, bend, puncture, or shred cells or batteries. If a battery leaks, do not let battery liquid touch skin or eyes. If this happens, immediately flush the affected areas with water, or seek medical help.

Do not modify, remanufacture, attempt to insert foreign objects into the battery, or immerse or expose it to water or other liquids. Batteries may explode if damaged.

Use the battery and charger for their intended purposes only. Improper use, or use of unapproved batteries or chargers may present a risk of fire, explosion, or other hazard, and may invalidate any approval or warranty. If you believe the battery or charger is damaged, take it to a service center for inspection before continuing to use it. Never use a damaged battery or charger. Only use the charger indoors.

Nokia battery authentication guidelines

Always use original Nokia batteries for your safety. To help ensure that you are getting an original Nokia battery, purchase it from a Nokia authorized service center or dealer, and check the hologram label.

Authenticate hologram

- 1 Look at the hologram. You should see the Nokia connecting hands symbol from one angle and the Nokia Original Accessories logo from the other angle.



- 2 Angle the hologram left, right, down, and up. You should see 1, 2, 3 and 4 dots on each side respectively.



However, this is not a total assurance of the authenticity of the battery. If you cannot confirm authenticity or if you have any reason to believe that your Nokia battery with the hologram on the label is not an authentic Nokia battery, stop using the battery and take it to the nearest Nokia authorized service center or dealer.

For additional information, refer to the warranty and reference leaflet included with your Nokia device.

Additional safety information

Emergency calls

Make an emergency call

- 1 Ensure the device is switched on.
- 2 Check for adequate signal strength. You may also need to do the following:
 - Insert a SIM card.
 - Remove call restrictions you have activated for your device, such as call restriction, fixed dialing, or closed user group.
 - Ensure your device is not in an offline or flight profile.
 - If the device screen and keys are locked, unlock them.
- 3 To clear the display, press the end key as many times as needed.
- 4 Select **Telephone**.
- 5 Enter the official emergency number for your present location. Emergency call numbers vary by location.
- 6 Press the call key.
- 7 Give the necessary information as accurately as possible. Do not end the call until given permission to do so.

118 Product and safety information



Important: Activate both cellular and internet calls, if your device supports internet calls. The device may attempt to make emergency calls both through cellular networks and through your internet call service provider. Connections in all conditions cannot be guaranteed. Never rely solely on any wireless device for essential communications like medical emergencies.

Small children

Your device, its battery and accessories are not toys. They may contain small parts. Keep them out of the reach of small children.

Medical devices

Operation of radio transmitting equipment, including wireless phones, may interfere with the function of inadequately protected medical devices. Consult a physician or the manufacturer of the medical device to determine whether they are adequately shielded from external RF energy. Switch off your device when regulations posted instruct you to do so, for example, in hospitals.

Implanted medical devices

Manufacturers of medical devices recommend a minimum separation of 15.3 centimeters (6 inches) between a wireless device and an implanted medical device, such as a pacemaker or implanted cardioverter defibrillator, to avoid potential interference with the medical device. Persons who have such devices should:

- Always keep the wireless device more than 15.3 centimeters (6 inches) from the medical device.
- Not carry the wireless device in a breast pocket.
- Hold the wireless device to the ear opposite the medical device.
- Turn the wireless device off if there is any reason to suspect that interference is taking place.
- Follow the manufacturer directions for the implanted medical device.

If you have any questions about using your wireless device with an implanted medical device, consult your health care provider.

Hearing



Warning:

When you use the headset, your ability to hear outside sounds may be affected. Do not use the headset where it can endanger your safety.

Some wireless devices may interfere with some hearing aids.

Nickel

The surface of this device is nickel-free.

Protect your device from harmful content

Your device may be exposed to viruses and other harmful content. Take the following precautions:

- Be cautious when opening messages. They may contain malicious software or otherwise be harmful to your device or computer.
- Be cautious when accepting connectivity requests, browsing the internet, or downloading content. Do not accept Bluetooth connections from sources you do not trust.
- Only install and use services and software from sources that you trust and that offer adequate security and protection.
- Install antivirus and other security software on your device and any connected computer. Only use one antivirus application at a time. Using more may affect performance and operation of the device and/or computer.

- If you access preinstalled bookmarks and links to third party internet sites, take the appropriate precautions. Nokia does not endorse or assume liability for such sites.

Operating environment

This device meets RF exposure guidelines in the normal use position at the ear or at least 1.5 centimeters (5/8 inch) away from the body. Any carry case, belt clip, or holder for body-worn operation should not contain metal and should position the device the above-stated distance from your body.

To send data files or messages requires a quality connection to the network. Data files or messages may be delayed until such a connection is available. Follow the separation distance instructions until the transmission is completed.

Vehicles

Radio signals may affect improperly installed or inadequately shielded electronic systems in motor vehicles such as electronic fuel injection, electronic antilock braking, electronic speed control, and air bag systems. For more information, check with the manufacturer of your vehicle or its equipment.

Only qualified personnel should install the device in a vehicle. Faulty installation or service may be dangerous and may invalidate your warranty. Check regularly that all wireless device equipment in your vehicle is mounted and operating properly. Do not store or carry flammable liquids, gases, or explosive materials in the same compartment as the device, its parts, or accessories. Remember that air bags inflate with great force. Do not place your device or accessories in the air bag deployment area.

Switch off your device before boarding an aircraft. The use of wireless devices in an aircraft may be dangerous to the operation of the aircraft and may be illegal.

Potentially explosive environments

Switch off your device in any area with a potentially explosive atmosphere. Obey all posted instructions. Sparks in such areas could cause an explosion or fire resulting in bodily injury or death. Switch off the device at refueling points such as near gas pumps at service stations. Observe restrictions in fuel depots, storage, and distribution areas; chemical plants; or where blasting operations are in progress. Areas with a potentially explosive atmosphere are often, but not always, clearly marked. They include areas where you would be advised to turn off your vehicle engine, below deck on boats, chemical transfer or storage facilities and where the air contains chemicals or particles such as grain, dust, or metal powders. You should check with the manufacturers of vehicles using liquefied petroleum gas (such as propane or butane) to determine if this device can be safely used in their vicinity.

Certification information (SAR)

This cellular device meets guidelines for exposure to radio waves.

Your cellular device is a radio transmitter and receiver. It is designed not to exceed the limits for exposure to radio waves recommended by international guidelines. These guidelines were developed by the independent scientific organization ICNIRP and include safety margins designed to assure the protection of all persons, regardless of age and health.

The exposure guidelines for cellular devices employ a unit of measurement known as the Specific Absorption Rate or SAR. The SAR limit stated in the ICNIRP guidelines is 2.0 watts/kilogram (W/kg) averaged over 10 grams of tissue. Tests for SAR are conducted using standard operating positions with the device transmitting at its highest certified power level in all tested frequency bands. The actual SAR level of an operating device can be below the maximum value because the device is designed to use only the power required to reach the network. That amount changes depending on a number of factors such as how close you are to a network base station.

The highest SAR value under the ICNIRP guidelines for use of the device at the ear is 1.18 W/kg .

Use of device accessories may result in different SAR values. SAR values may vary depending on national reporting and testing requirements and the network band. Additional SAR information may be provided under product information at www.nokia.com.

Your cellular device is also designed to meet the requirements for exposure to radio waves established by the Federal Communications Commission (USA) and Industry Canada. These requirements set a SAR limit of 1.6 W/kg averaged over one

gram of tissue. The highest SAR value reported under this standard during product certification for use at the ear is 1.29 W/kg and when properly worn on the body is 0.69 W/kg .

Copyright and other notices

DECLARATION OF CONFORMITY

CE 0434 Ⓢ

Hereby, NOKIA CORPORATION declares that this RM-719 product is in compliance with the essential requirements and other relevant provisions of Directive 1999/5/EC. A copy of the Declaration of Conformity can be found at http://www.nokia.com/phones/declaration_of_conformity/.

© 2011 Nokia. All rights reserved.

Nokia and Nokia Connecting People are trademarks or registered trademarks of Nokia Corporation. Nokia tune is a sound mark of Nokia Corporation. Other product and company names mentioned herein may be trademarks or tradenames of their respective owners.

Reproduction, transfer, distribution, or storage of part or all of the contents in this document in any form without the prior written permission of Nokia is prohibited. Nokia operates a policy of continuous development. Nokia reserves the right to make changes and improvements to any of the products described in this document without prior notice.



Java and all Java-based marks are trademarks or registered trademarks of Sun Microsystems, Inc.

This product is licensed under the MPEG-4 Visual Patent Portfolio License (i) for personal and noncommercial use in connection with information which has been encoded in compliance with the MPEG-4 Visual Standard by a consumer engaged in a personal and noncommercial activity and (ii) for use in connection with MPEG-4 video provided by a licensed video provider. No license is granted or shall be implied for any other use. Additional information, including that related to promotional, internal, and commercial uses, may be obtained from MPEG LA, LLC. See <http://www.mpegla.com>.

To the maximum extent permitted by applicable law, under no circumstances shall Nokia or any of its licensors be responsible for any loss of data or income or any special, incidental, consequential or indirect damages howsoever caused.

The contents of this document are provided "as is." Except as required by applicable law, no warranties of any kind, either express or implied, including, but not limited to, the implied warranties of merchantability and fitness for a particular purpose, are made in relation to the accuracy, reliability or contents of this document. Nokia reserves the right to revise this document or withdraw it at any time without prior notice.

Reverse engineering of software in the device is prohibited to the extent permitted by applicable law. Insofar as this user guide contains any limitations on Nokia's representations, warranties, damages and liabilities, such limitations shall likewise limit any representations, warranties, damages and liabilities of Nokia's licensors.

The availability of products, features, applications and services may vary by region. For more information, contact your Nokia dealer or your service provider. This device may contain commodities, technology or software subject to export laws and regulations from the US and other countries. Diversion contrary to law is prohibited.

Nokia does not provide a warranty for or take any responsibility for the functionality, content, or end-user support of third-party applications provided with your device. By using an application, you acknowledge that the application is provided as is.

Nokia does not make any representations, provide a warranty, or take any responsibility for the functionality, content, or end-user support of third-party applications provided with your device. The availability of Ovi services may vary by region.

FCC/INDUSTRY CANADA NOTICE

Your device may cause TV or radio interference (for example, when using a telephone in close proximity to receiving equipment). The FCC or Industry Canada can require you to stop using your telephone if such interference cannot be eliminated. If you require assistance, contact your local service facility. This device complies with part 15 of the FCC rules. Operation is subject to the following two conditions: (1) This device may not cause harmful interference, and (2) this device must accept any interference received, including interference that may cause undesired operation. Any changes or modifications not expressly approved by Nokia could void the user's authority to operate this equipment.

Some operations and features are SIM card and/or network dependent, MMS dependent, or dependent on the compatibility of devices and the content formats supported. Some services are subject to a separate charge.

/Issue 1.0 EN-US