



K-Bar Industries, Faribault, MN 55021

# M157300E

Item Numbers: 157300,157301  
157302

# Owner's Manual

## Pressure Washer: Machine that cleans dirty surfaces with high pressure water.



### ⚠ WARNING

**Read this manual.**

Serious injury or death can result if safety instructions are not followed.

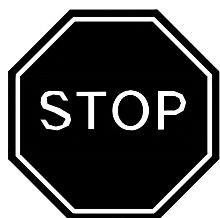

**Pump is shipped with oil.**

- Remove shipping tape from pump oil fill cap. (Cat Pumps)
- Remove shipping plug and install vented fill cap. (Comet Pumps)
- See pump oil cap section of this manual.

**Closely inspect all components.**

- If you have damaged components: Contact the freight company that delivered the unit and file a claim.
- If you have missing components: Contact Customer Service at 1-800-270-0810.

fig02342

**Any Questions, Comments, Problems or Parts Orders**

Call NorthStar Customer Service 1-800-270-0810

# Hazard Signal Word Definitions





	<p>This is the safety alert symbol. It is used to alert you to potential personal injury hazards. Obey all safety messages that follow this symbol to avoid possible injury or death.</p>
	<p>DANGER (red) indicates an imminently hazardous situation which, if not avoided, will result in death or serious injury.</p>
	<p>WARNING (orange) indicates a potentially hazardous situation which, if not avoided, could result in death or serious injury.</p>
	<p>CAUTION (yellow) indicates a potentially hazardous situation which, if not avoided, may result in minor or moderate injury.</p>
	<p>CAUTION (yellow) used without the safety alert symbol indicates a potentially hazardous situation which, if not avoided, may result in property damage.</p>

fig01453

# Table of Contents

▲ Important Safety Instructions.....	4-5
▲ Warning Label Locations.....	6
Assembly Instructions.....	7-9
Machine Component Identification.....	10
Pump Oil Cap and Pump Component Identification.....	11
▲ Operation Instructions.....	11-15
Water Supply.....	11
Start-Up/Shut-Down Instructions.....	12
Spray Gun Safety Lock and Attaching the Lance..	13
Installing Nozzles and Quick Connect hoses.....	14
Applying Chemicals.....	15
▲ Maintenance and Storage.....	16-18
Maintenance Mode and Maintenance Schedule...	16
Pump Oil Change.....	17
Winter Storage.....	18
Troubleshooting.....	19
Specifications.....	20
Parts Explosions.....	22

## **▲ Important Safety Instructions**

**WARNING** -Risk of Injection or Injury to Persons - Do Not Direct Discharge Stream at Persons. - Do not use a hose if exterior damage is evident.  
-Risk of explosion. - Do not spray flammable liquids. - Do not operate in a flammable environment.

**CAUTION** -Gun kicks back. Hold with both hands.  
-To reduce the risk of injury, read operating instructions carefully before use.

**WARNING** - When using this product basic precautions should always be followed, including the following:

- 1.) Read all the instructions before using the product.
- 2.) To reduce the risk of injury, close supervision is necessary when the product is used near children. Do not allow irresponsible use by children. Always stop the product and bleed pressures before leaving unattended, disconnecting hoses or servicing the pump.
- 3.) Know how to stop the product and bleed pressures quickly. Be thoroughly familiar with the controls.
- 4.) Stay alert - watch what you are doing.
- 5.) Do not operate the product when fatigued or under the influence of alcohol or drugs.
- 6.) Keep operating area clear of all persons.
- 7.) Do not overreach or stand on unstable support. Keep good footing and balance at all times. Wear footwear capable of maintaining a good grip on wet surfaces - Do not place the machine on soft or unstable ground.
- 8.) Follow the maintenance instructions specified in all manuals. Do not run machine without sufficient lubrication or sufficient water to cool the pump.
- 9.) Wear safety glasses, gloves, face protection and appropriate clothing when operating the machine.
- 10.) Do not operate this machine with broken or missing parts. - Never alter the manufacturer's original design or deactivate any safety device on the machine.
- 11.) Risk of exposure to dangerous chemicals. Wear protective gloves when handling and cleaning with chemicals. Follow the chemical manufacturer's directions. Understand all safety hazards and first aid for all chemicals being used. Check whether dangerous chemicals have been used and take any precautions that may have been recommended by the supplier of these chemicals when cleaning filters. Do not pump highly abrasive fluids or use with incompatible chemicals or solvents.
- 12.) Know the pressure and temperature limits of your machine. Be sure all high pressure accessories meet or exceed your machine's limits. Do not set the pressure relief valve above the machine's limit.
- 13.) Do not move this machine by pulling on the hose. Do not use the pump to support other items of equipment that impose unacceptable loads on the pump. Do not attempt to use this machine as a prop.
- 14.) To reduce risk of injury, do not secure the spray gun open. Your spray gun is equipped with a built-in trigger safety latch to guard against accidental trigger release and potentially dangerous high pressure spray. Rotate the safety latch to the locked position when not spraying.
- 15.) Do not clean this machine with its own spray. Cleaning should be done with a damp sponge with the motor OFF.
- 16.) Always make sure all switches and controls are in the OFF position prior to plugging in the electrical cord. Do not stand in water while plugging and unplugging electrical cord.
- 17.) This product is provided with a ground fault circuit interrupter built into the power cord plug. If replacement of the plug or cord is needed, use only identical replacement parts.

**SAVE THESE INSTRUCTIONS**

# Grounding Instructions

This product must be grounded. If it should malfunction or breakdown, grounding provides a path of least resistance for electric current to reduce the risk of electrical shock. This product is equipped with a cord having an equipment-grounding conductor and a grounding plug. The plug must be plugged into an appropriate outlet that is properly installed and grounded in accordance with all local codes and ordinances.

**DANGER** - Improper connection of the equipment - grounding conductor can result in a risk of electrocution. Check with a qualified electrician or service personnel if you are in doubt as to whether the outlet is properly grounded. Do not modify the plug provided with the product - if it will not fit the outlet, have a proper outlet installed by a qualified electrician. Do not use any type adapter with this product.

## 1. For a product rated 125 volts or less:

### **GROUND FAULT CIRCUIT INTERRUPTER PROTECTION**

This pressure washer is provided with a ground fault circuit interrupter (GFCI) built into the plug of the power supply cord. This device provides additional protection from the risk of electric shock. Should replacement of the plug or cord become necessary, use only identical replacement parts that include GFCI protection.

## 2. For a product rated more than 125 volts:

### **GROUND FAULT CIRCUIT INTERRUPTER PROTECTION**

To comply with the National Electric Code (NFPA 70) and to provide additional protection from the risk of electric shock, this pressure washer should only be connected to a receptacle that is protected by a ground fault circuit interrupter (GFCI).

# Extension Cords

Use only 3-wire extension cords that have 3 prong grounding-type plugs and 3-pole cord connectors that accept the plug from the product. Use only extension cords that are intended for outdoor use. These extension cords are identified by a marking "Acceptable for use with outdoor appliances; store indoors while not in use." Use only extension cords having an electrical rating not less than the rating of the product. Do not abuse extension cord and do not yank on any cord to disconnect. Keep cord away from heat and sharp edges. Always disconnect the extension cord from the receptacle before disconnecting the product from the extension cord.



Warning - To reduce the risk of electrocution, keep all connections dry and off the ground. do not touch plug with wet hands.

**SAVE THESE INSTRUCTIONS**

# ▲ Warning Label Locations

START-UP INSTRUCTIONS	SHUT-DOWN INSTRUCTIONS
1. Attach garden hose.	1. Turn motor OFF.
2. Attach pressure hose.	2. Unplug the power cord.
3. Attach gun and lance.	3. Turn water supply OFF.
4. Turn water supply ON.	4. Squeeze trigger to relieve system pressure.
5. Squeeze trigger to purge air from pump.	5. Remove garden hose.
6. Insert nozzle.	6. Remove pressure hose.
7. Plug in power cord, reset the GFCI, start motor.	



▲WARNING	
	•Gun kicks back. Hold with both hands.
	•Risk of injection or injury to persons. Do not direct discharge stream at persons.
	•Risk of fire and explosion. Do not spray flammable liquids.
	•To reduce the risk of injury, read owner's manual carefully before using.

©2005 NTH-E Co. 800-270-0810 Part No. 778069

Motor and pump not shown for clarity.

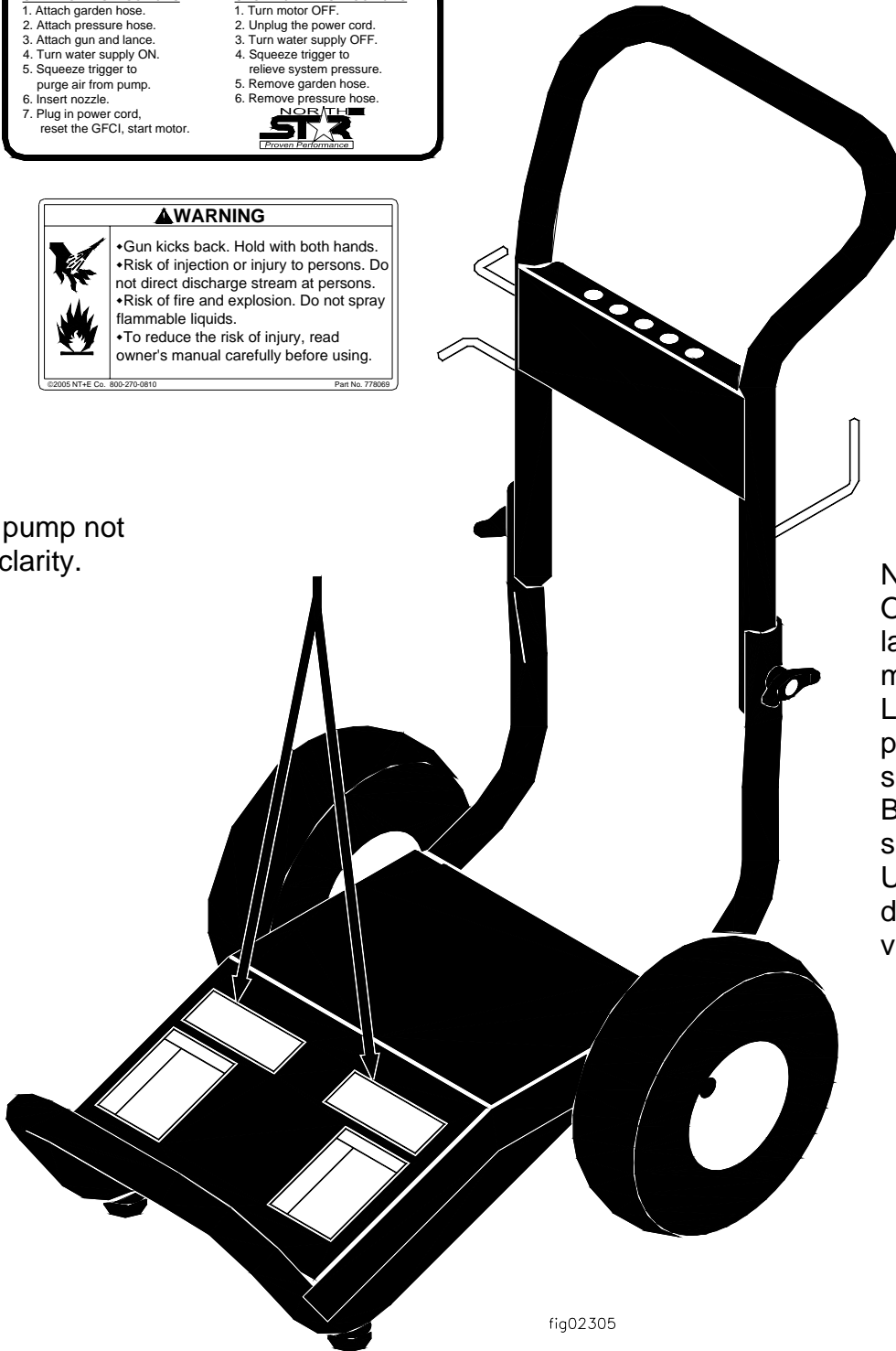

**NOTE:**  
 Only one set of labels is used per machine.  
 Labels may be placed on right or left side of machine.  
 Both locations are shown.  
 Use the location that does not obstruct viewing labels.

fig02305

**Call 1-800-270-0810 to order new labels.**  
Instruction Label: Part No. 778166  
Warning Label: Part No. 778069

# Machine Component Identification

## I.) Unpack

Your pressure washer is shipped in one box. Separate and identify the components found in both boxes.

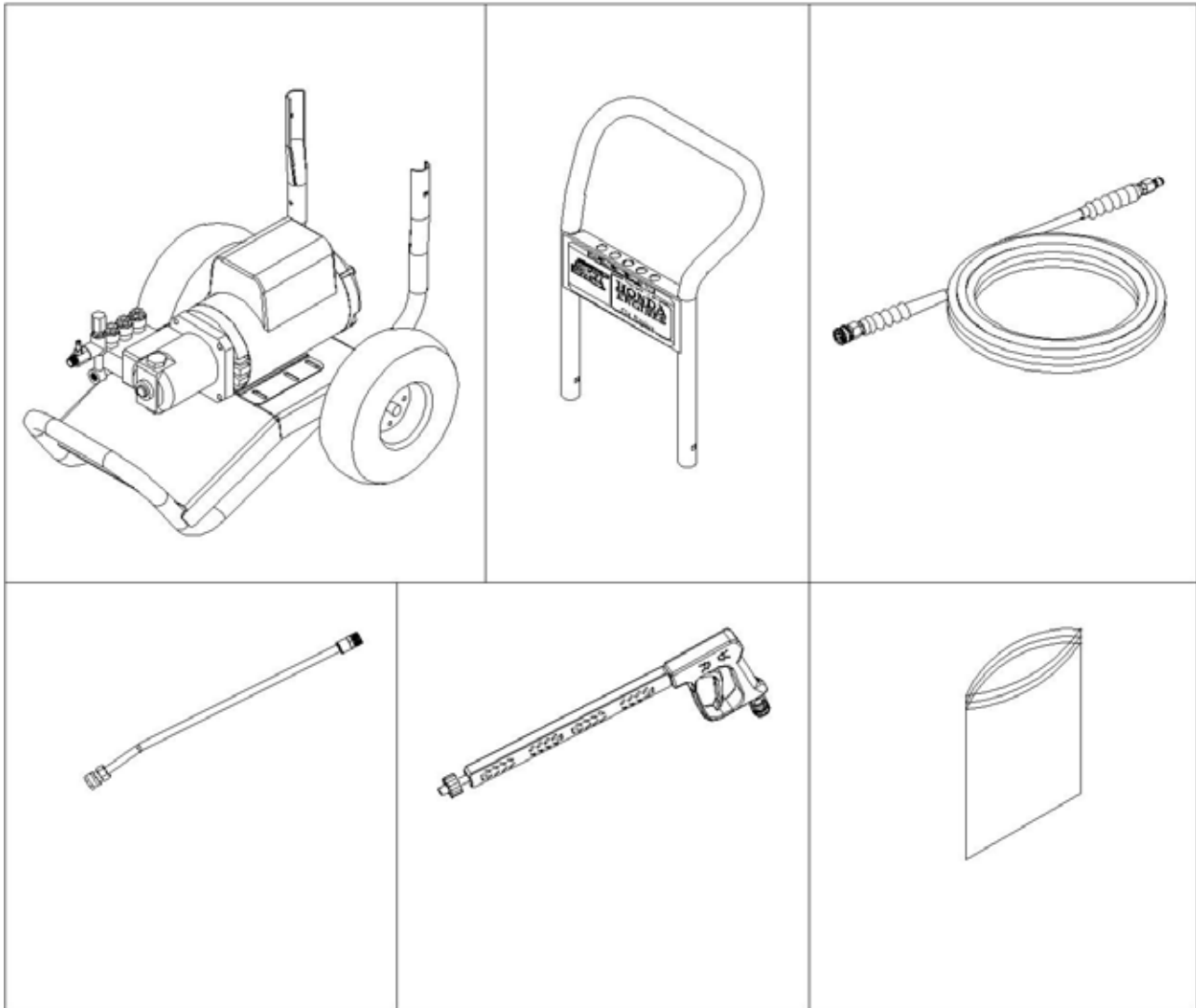

fig02299

\* Figures shown are for representation only. Actual components will vary by model.

**Any Questions, Comments, Problems or Parts Orders**  
**Call NorthStar Customer Service 1-800-270-0810**

# Machine Component Identification

## II.) Hardware Bag



Flange Nut – Qty 8  
Part # 82019



Washer – Qty 2  
Part # 82021



Lock Nut – Qty 2  
Part # 82013

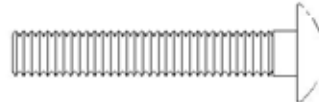

Carriage Bolt - Qty 2  
Part # 82233



T-Handle – Qty 2  
Part # 38578

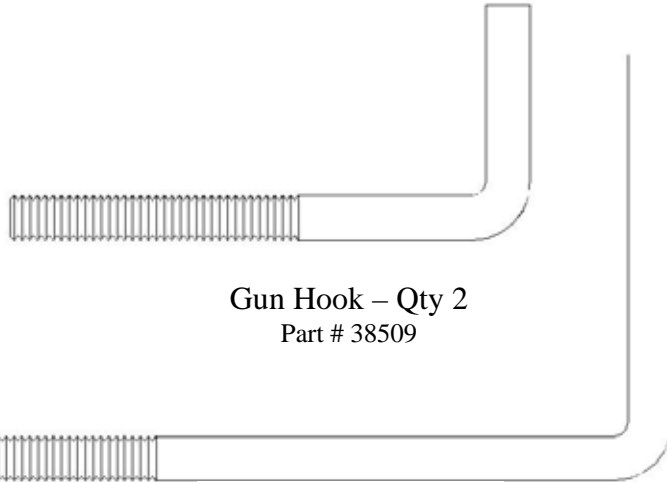

Gun Hook – Qty 2  
Part # 38509

Hose Hook – Qty 3  
Part # 38510

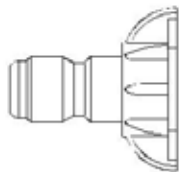

Nozzle – Qty 2  
Part # 778150



Grommet – Qty 5  
Part # 35198

fig02301



# Machine Component Identification

## III.) Handle Assembly

- 1.) Attach handle to base with two carriage bolts and t-handle knobs.
- 2.) Spin a flange nut backwards onto two hose hooks and each gun hook. (see hook detail)
- 3.) Mount the hose hooks and gun hooks onto the handle as shown.
- 4.) Make sure the top gun hook points back and the bottom gun hook points forward.
- 5.) Spin a lock nut onto the last hose hook and push on a washer (see top hook detail). Mount the top hose hook with another washer and lock nut. Tighten lock nut until it is tight enough to hold hose hook upright but it can still spin. This allows you to turn hook to remove the power cord quickly.
- 6.) Insert grommets into the holes on the handle nameplate.
- 7.) Press nozzles into grommets according to the colors indicated on the handle decal.

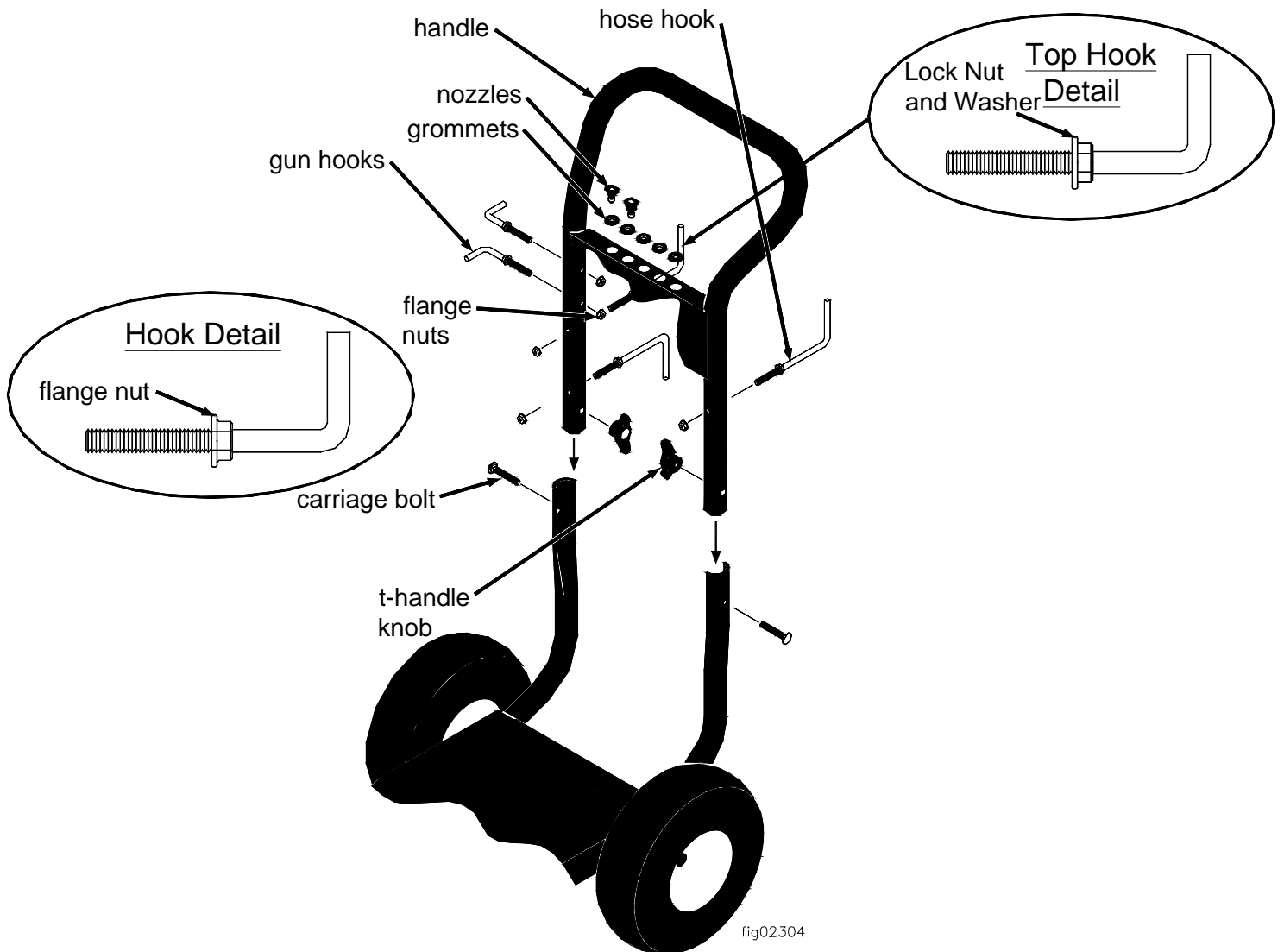

# Machine Component Identification

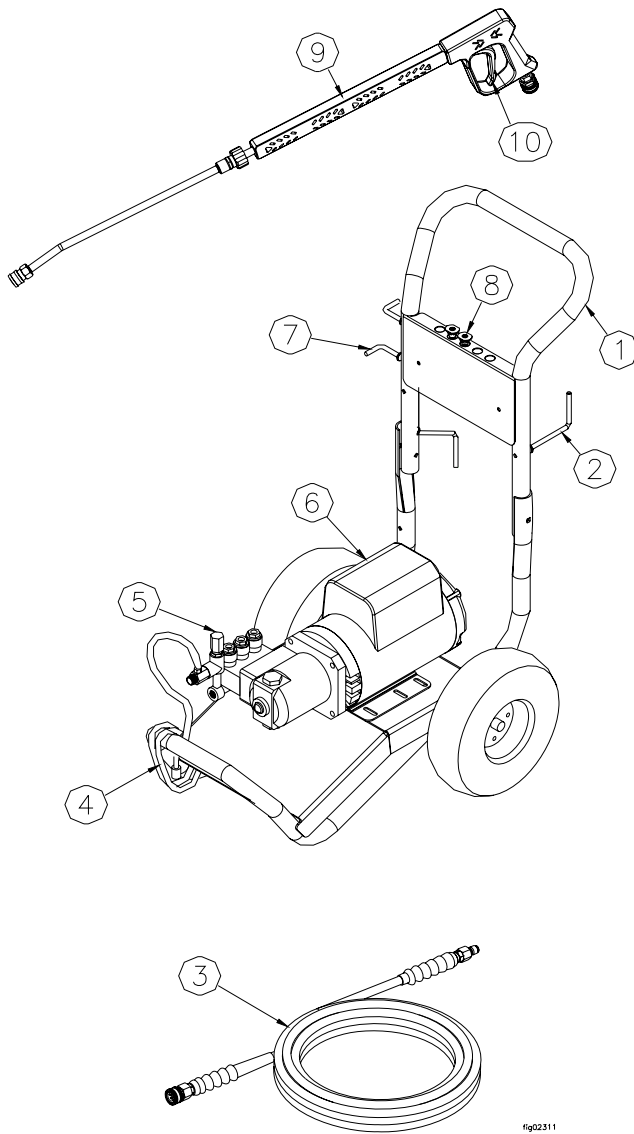

fig02311

- 1.) **Handle.** Designed for easy cart movement.
- 2.) **Hose Hook.** Store hose on hook.
- 3.) **Pressure Hose.** Attach quick couplers to gun and water outlet.
- 4.) **Chemical Hose.** Submerge in cleaning solution.
- 5.) **Water Pump.** Inspect for loose/broken parts prior to each use.
- 6.) **Motor.** Leeson motor provides years of reliable use.
- 7.) **Gun Hook.** Store gun on hook.
- 8.) **Nozzles.**
- 9.) **Spray Gun.** Always use two hands for safe operation.
- 10.) **Trigger.** Actuate to allow pressurized water to flow out of spray gun.

\*Note: 157301 shown, location of components on other models vary slightly.

# Pump Component Identification

## 157300

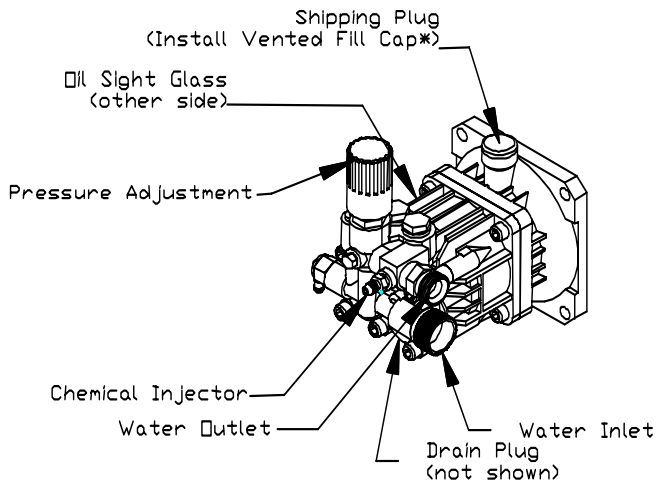

\*Note: Discard Shipping Plug and O-ring

## 157301 & 157302

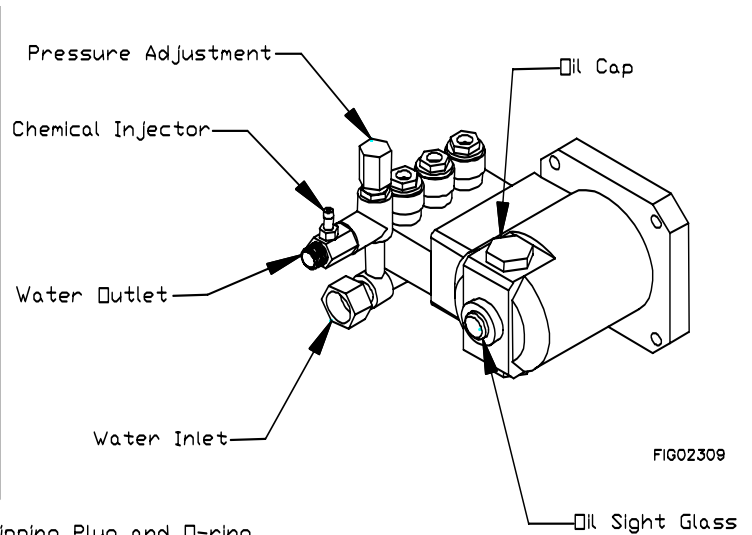

## ▲ Operation Instructions

### Water Supply

- 1.) Make sure the water supply is clean. Debris can cause excess pump wear and reduce performance.
- 2.) An insufficient water supply will damage your pump. Make sure the water supply is steady and is 20% over the rated flow of your pump. Use a stopwatch to time how long it takes to fill a 5 gallon bucket with your garden hose. The bucket must fill faster than the times listed in the table below.

Model	Time to fill 5 gallon bucket
157300	150 seconds
157301	160 seconds
157302	96 seconds

- 3.) The water supply garden hose must have an inside diameter of at least 5/8". If the hose is more than 100 ft. long, the diameter must be at least 3/4".
- 4.) Never use a reservoir tank as a water source. Drawing water out of a tank may cause pump cavitation and damage to your pump. This pressure washer is designed for a pressurized water source such as a city water faucet. However, the water source pressure must not exceed 115 psi (8 bar).
- 5.) Always use a flexible rubber hose for your water supply. Do not use rigid piping.

# ⚠ Operation Instructions

## **START-UP INSTRUCTIONS**

1. Attach garden hose.
2. Attach pressure hose.
3. Attach gun and lance.
4. Turn water supply ON.
5. Squeeze trigger to purge air from pump.
6. Insert nozzle.
7. Plug in power cord
8. Reset the GFCI button on the cord
9. Start motor.

## **SHUT-DOWN INSTRUCTIONS**

1. Turn motor OFF.
2. Unplug the power cord.
3. Turn water supply OFF.
4. Squeeze trigger to relieve system pressure.
5. Remove garden hose.
6. Remove pressure hose.

## ⚠ **WARNING**



### **Skin puncture hazard.**

High pressure fluid can inject under skin resulting in serious injury including amputation. Do not direct spray at people or animals.

-If skin injection happens, seek IMMEDIATE surgical treatment.

-Do not check for leaks with hand. Instead, use a piece of cardboard to check for leaks.

-Do not use unit if exterior hose damage is evident. Make sure all fittings are tight before starting. Relieve system pressure before servicing.

-Know how to stop engine and bleed pressures quickly. Be thoroughly familiar with the controls.

-Make sure accessories meet the unit's temperature and pressure limits.

-Stop engine and bleed pressures before leaving unit unattended.

fig01863

# ▲ Operation Instructions

## Spray Gun Safety Lock

When not spraying, use the spray gun safety lock to prevent accidental high pressure discharge.

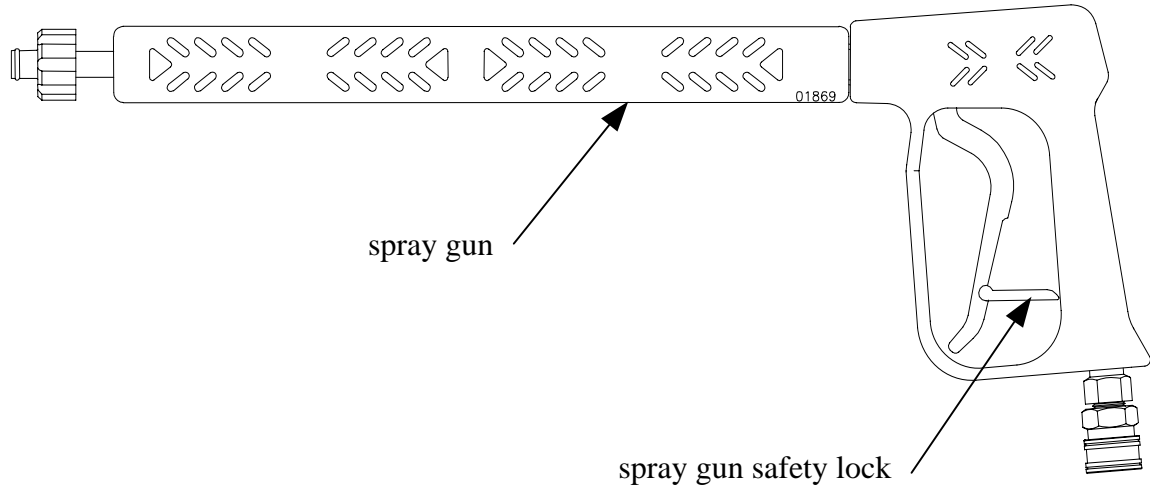

## Attaching the Lance

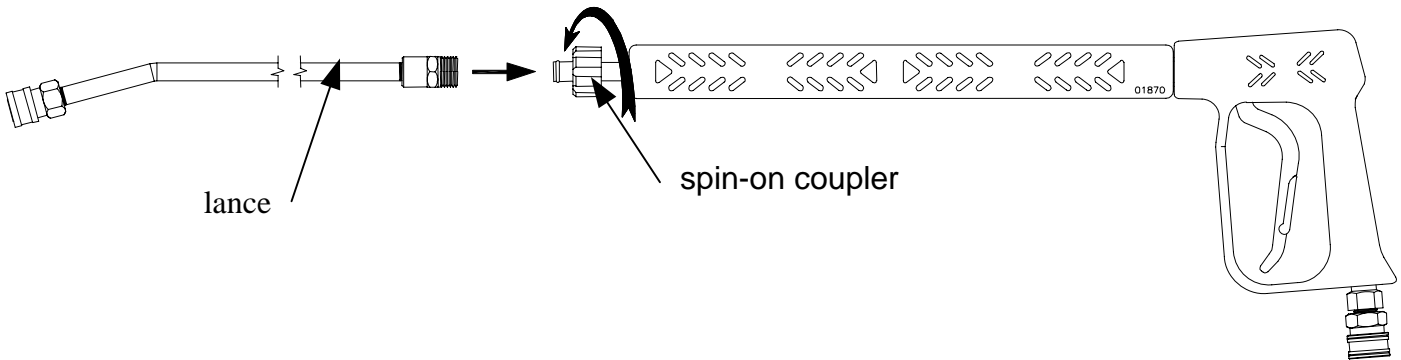

Tighten spin-on coupler hand tight.

Note: The o-rings make the seal so there is no need to tighten with a wrench.

## ⚠ Operation Instructions

### Installing Nozzles

To install a nozzle pull back the collar and push the nozzle into the coupler. Once the connection is made, pull on the nozzle to make sure it is secure.

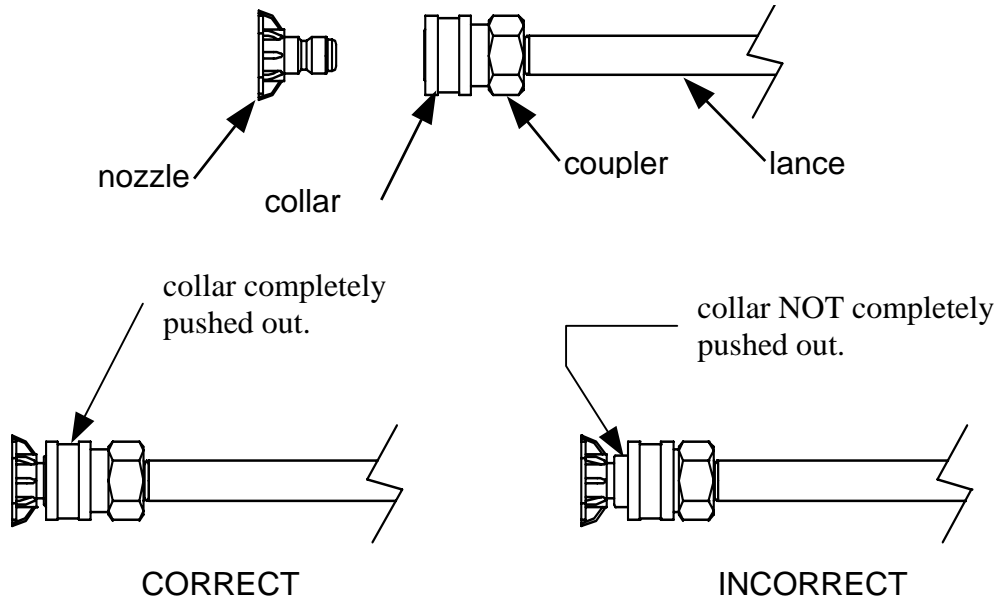

## ⚠ WARNING

### **Flying objects.**

Make sure nozzle is secure before squeezing trigger. If nozzle is not secure it will become a projectile. Serious injury can occur.

fig01864

### Attach Quick Connect Couplers

-To install the hose onto the pump, pull back the collar and push the hose into the coupler on the pump.

-To install the hose onto the spray gun, pull back the collar on the spray gun and push the hose into the coupler on the spray gun.

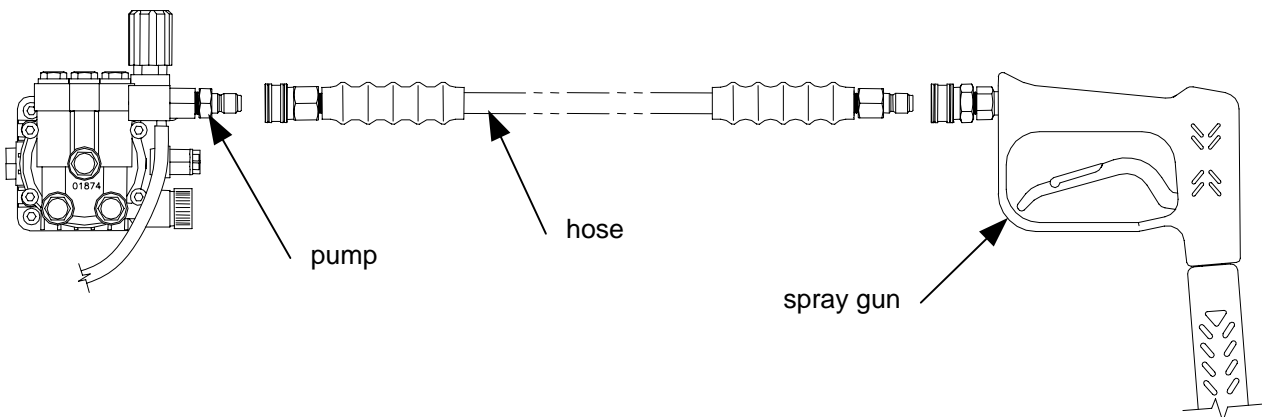

Once the connections are made, pull on the hose to make sure it is secure.

## ⚠ Operation Instructions

### Applying Chemicals

- 1.) Install the black nozzle when applying chemicals onto the cleaning surface.
- 2.) Start the pressure washer according to the start-up instructions.
- 3.) Submerge the chemical hose in cleaning solution.
- 4.) Squeeze the spray gun trigger. The chemical injector will draw the chemical into the water stream.
- 5.) Apply chemicals evenly onto the cleaning surface. Allow the chemicals to react with the dirt, then clean at high pressure with high pressure (green or yellow) nozzle.
- 6.) Never use more chemical than is necessary to clean the surface.
- 7.) To clean the chemical injector, draw water through the strainer until all the chemical is purged from the system.

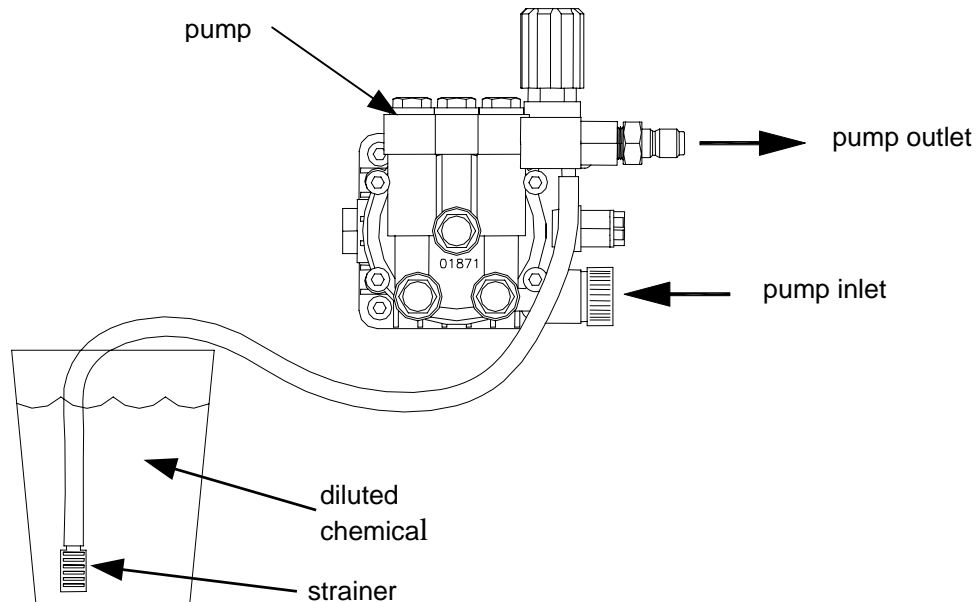

## ⚠ WARNING

### **Risk of exposure to dangerous chemicals.**

Serious injury or death can result if chemical manufacturer instructions are not followed.

- Wear protective gloves when handling and cleaning with chemicals.
- Understand all safety hazards and first aid for all chemicals being used.
- When cleaning filters, check if chemicals have been used and take any precautions that are recommended by the chemical manufacturer.
- Different chemicals may interact dangerously with each other, always follow chemical manufacturer directions before switching chemicals.
- Calculate the correct amount of chemical to mix, dispose of excess chemical per the manufacturer instructions.
- Never spray flammable liquids.



fig01846

## ⚠ Maintenance and Storage

### Maintenance Mode

Before performing any maintenance on the pressure washer, it must be placed in maintenance mode.

- 1.) Turn off motor and unplug cord.
- 2.) Turn off water supply.
- 3.) Squeeze trigger to relieve system pressure.

### Maintenance Schedule

What to Check	When To Check	What to Do
Inlet Filter	Each Use	Visually inspect and clean inlet filter with clear water.
Pressure Hose	Each Use	Visually inspect pressure hose and hose couplings. Replace hose if any of the following is evident: hose coupling is damaged, wire mesh is exposed or damaged, hose is permanently kinked or flattened, outer hose cover is blistered or loose.
Bolts	Each Use	Tighten any loose bolts.
Pump Oil	After 1 <sup>st</sup> 50hrs, then 3mo/500hr	Change pump oil. See pump oil change instructions on next page.

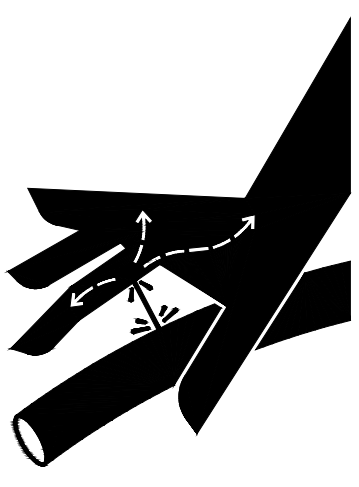

### ⚠ WARNING

**Skin injection hazard.**

High pressure fluid can inject under skin resulting in serious injury including amputation.

- Make sure all fittings are tight before applying pressure. Relieve system pressure before servicing.
- Do not check for leaks with hand. Instead, use a piece of cardboard to check for leaks.
- If skin injection happens, seek immediate "Surgical Treatment".

fig01454



## ▲ Maintenance and Storage

### Pump Oil Change

- 1.) Place a suitable container below the pump to catch the used oil, then remove the oil fill cap and oil drain plug.
- 2.) Allow the used oil to drain completely, then reinstall the drain plug and tighten securely.
- 3.) Please dispose of used oil in a manner that is compatible with the environment. We suggest you take used oil in a sealed container to your local recycling center or service station for reclamation. Do not throw it in the trash, pour it on the ground or down the drain.
- 4.) With the pump in a level position, fill to the halfway point on the oil sight glass (see pump oil capacities below). For Comet pumps use Universal Tractor Transmission Oil or Mobil 1 15W50 synthetic oil. For Cat pumps use SAE30 non-detergent oil or Cat Pump Oil Item# 22158.

<b>Comet BXD 1617E Pump</b>	<b>Cat 3DX25GSI Pump</b>	<b>Cat 2DX20ES Pump</b>
 <p>fill cap</p> <p>sight glass</p> <p>drain plug</p> <p><b>Oil capacity: 4.3oz. (.13L)</b></p>	 <p>fill cap</p> <p>sight glass</p> <p>drain plug</p> <p><b>Oil capacity: 8.5 oz. (.25L)</b></p>	 <p>fill cap</p> <p>sight glass</p> <p>drain plug</p> <p><b>Oil capacity: 8.5 oz. (.25L)</b></p>

FIG01854

## ▲ Maintenance and Storage

### Winter Storage

Protect your pump, hose and gun from freezing.

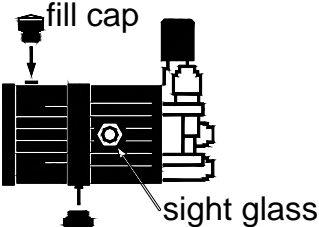
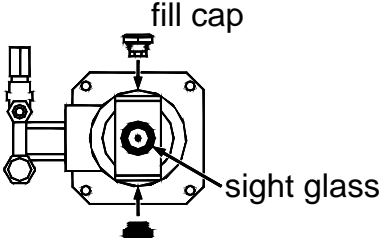
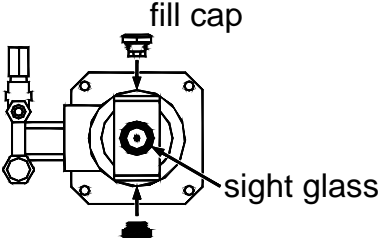
Items needed: 12" piece of garden hose or equivalent, funnel and RV antifreeze (approximately 6 oz.)

- 1.) Follow the storage instructions listed above.
- 2.) Make sure the motor start switch is OFF.
- 3.) Attach the garden hose with funnel to the pump inlet (see illustration).
- 4.) Pour RV antifreeze into the funnel, run motor until antifreeze comes out the pump outlet.
- 5.) Drain all water from the high pressure hose. Depress trigger on gun and drain all water out of gun/lance.

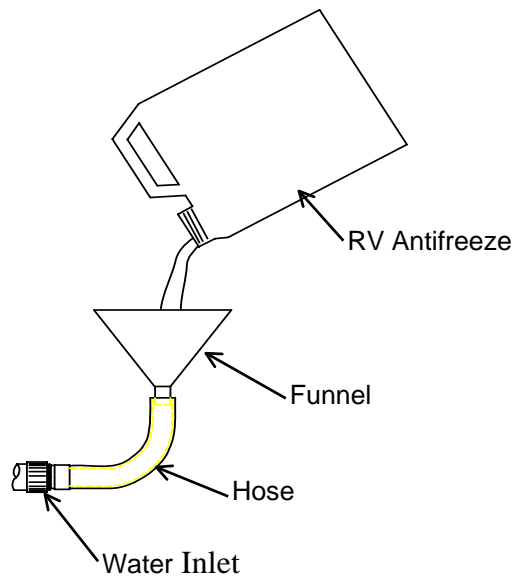

# Troubleshooting

<b>Problem</b>	
Motor will not start	SOLUTION: A,B
Low/Surging pressure or no water flow	SOLUTION: C,D,E,F,G,H
No chemical injection	SOLUTION: I,J,K,L
<b>Cause</b>	<b>Solution</b>
<b>A-</b> Tripped GFCI cord	Reset GFCI cord
<b>B-</b> Tripped motor relay	Reset motor
<b>C-</b> Insufficient water supply	See water supply section of this manual
<b>D-</b> Plugged pump inlet filter	See maintenance section of this manual
<b>E-</b> Wrong nozzle	Make sure high pressure nozzle is being used
<b>F-</b> Plugged nozzle	Remove nozzle, check for blockage
<b>G-</b> Worn nozzle	Replace nozzle
<b>H-</b> Leak in pressure hose	Replace pressure hose
<b>I-</b> Wrong nozzle	Make sure chemical nozzle is being used
<b>J-</b> Back pressure from extra long discharge hose	Try shorter hose
<b>K-</b> Leak in chemical siphon hose	Replace hose – use hose clamps if necessary
<b>L-</b> Chemical strainer not submerged	Make sure strainer is completely submerged

The manufacturer reserves the right to make improvements in design and/or changes in specifications at any time without incurring any obligation to install them on units previously sold.

**Any Questions, Comments, Problems or Parts Orders**

Call NorthStar Customer Service 1-800-270-0810

# Specifications

## 157300

PSI (bar)	1700 (117)
GPM (l/min)	1.5 (5.7)
Max Water Temp	140°F (60°C)
Dimensions L x W x H	33.5" X 20.9" X 38.6" (851mm x 531mm x 980mm)
Weight	95 lb (44kg)

## 157301

PSI (bar)	2000 (138)
GPM (l/min)	1.5 (5.7)
Max Water Temp	140°F (60°C)
Dimensions L x W x H	33.5" X 20.9" X 38.6" (851mm x 531mm x 980mm)
Weight	115 lb (44kg)

## 157302

PSI (bar)	2750 (190)
GPM (l/min)	2.5 (9.4)
Max Water Temp	140°F (60°C)
Dimensions L x W x H	33.5" X 20.9" X 38.6" (851mm x 531mm x 980mm)
Weight	139 lb (55kg)

# Wiring Diagram

157300

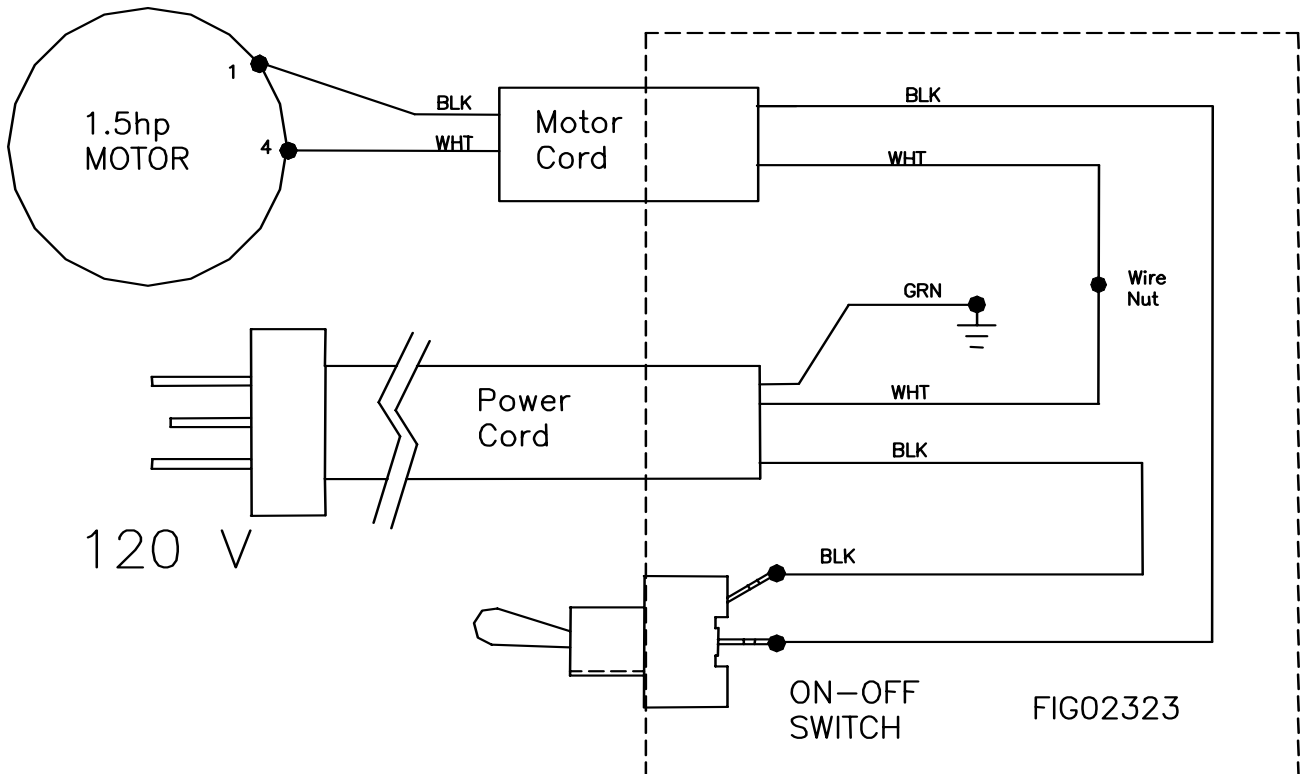

# Wiring Diagram

157301

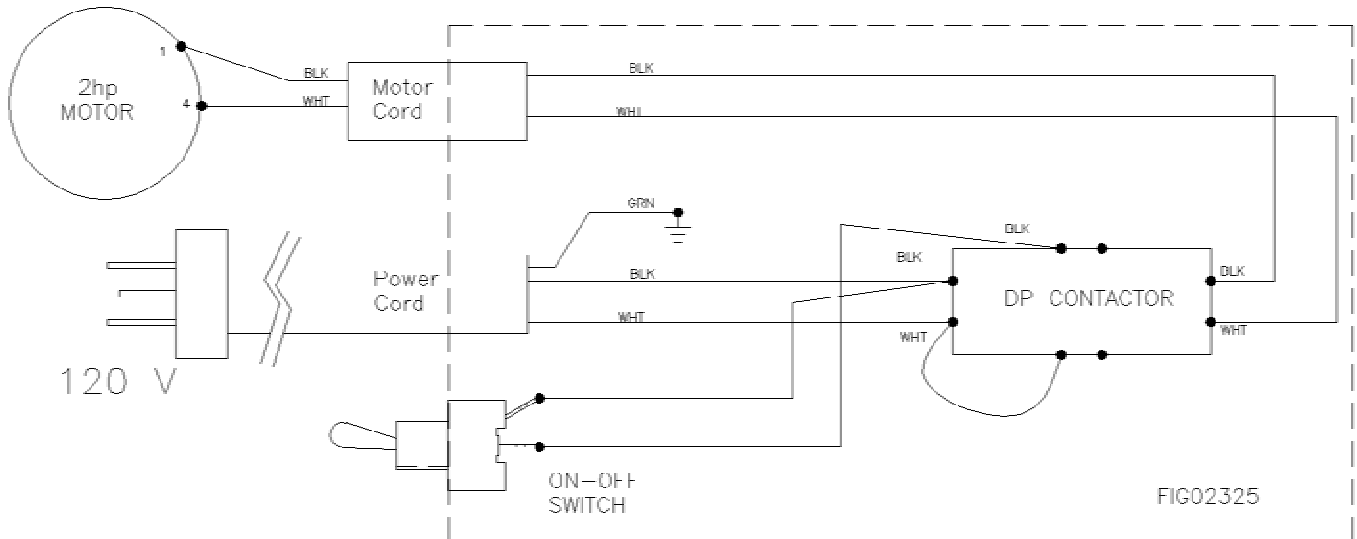

157302

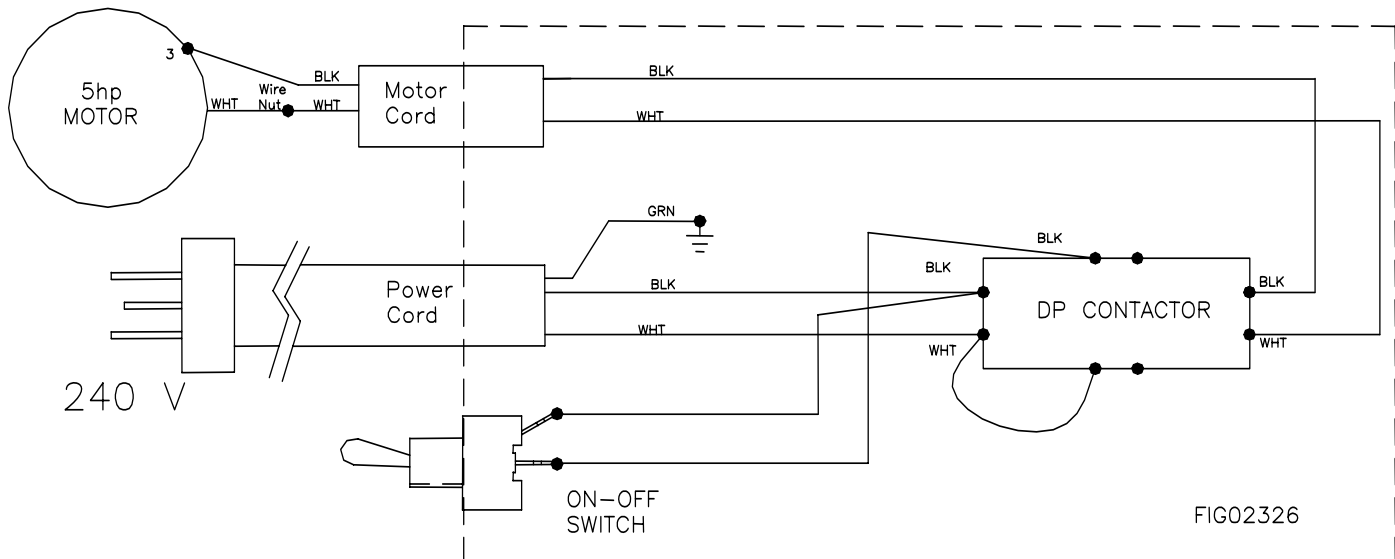

# Part Explosion M157300 Rev E

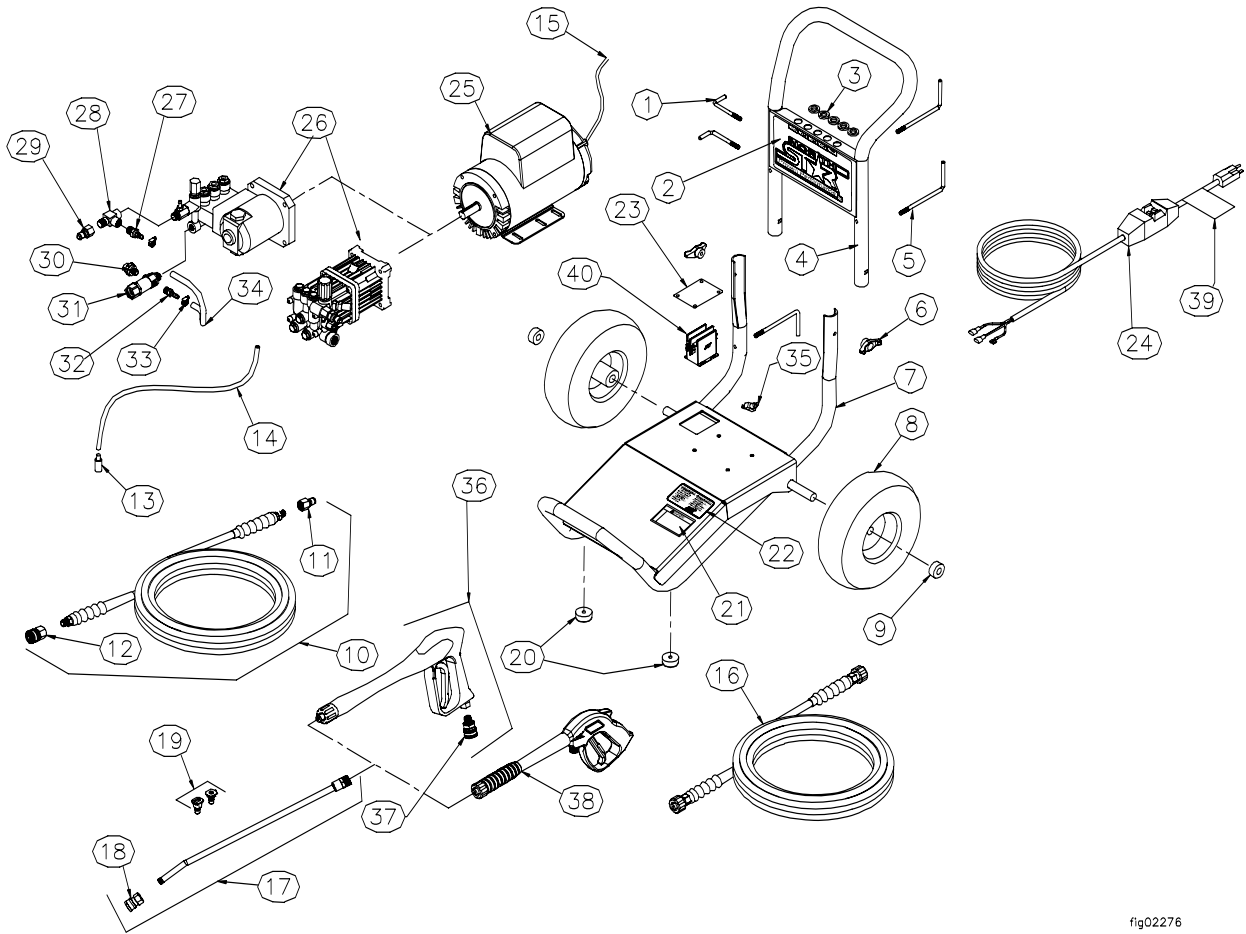

fig02276

ITEM	PART#	DESCRIPTION	QTY	Models
1	38509	Threaded Gun Hook	2	All
2	778065	NorthStar Decal	1	All
3	35198	7/16 ID Grommet	5	All
4	778059	Handle	1	All
5	38510	Threaded Hose Hook	3	All
6	38578	T-Handle Knob	2	All
7	778125	Base	1	157300
	778129	Base	1	157301,2
8	2278	Tire Wheel Assembly	2	All
9	305200	Wheel Retainer	2	All
10	38524	5/16 x 25' Gray Hose	1	157301,2
11	777915	3/8" Quick Connect Nipple	1	157301,2
12	777914	3/8" Quick Connect Coupler	1	157301,2
13	2212	Chemical Strainer	1	All
14	777165	1/4" Braided Chemical Hose	3 ft	All
15	778146	Motor Cord, 14-2 AWG SJTW	1	157300
	778147	Motor Cord, 12-2 AWG SJTW	1	157301,2
16	38523	1/4 x 25' Blk Hose	1	157300
17	779166	18.5" Lance	1	All
18	777904	1/4" Quick Connect	1	All
19	778150	Nozzle 2 pack #2.0	1	157300,1
	38530	Nozzle 2 pack #3.0	1	157302
20	2215	Bumpers	2	All
21	778069	Warning Decal	1	All
22	778166	Instruction Decal	1	All

ITEM	PART#	DESCRIPTION	QTY	Models
23	778128	Electric Control Box Cover	1	157300
	778132	Electric Control Box Cover	1	157301,2
24	778140	GFCI Cord, 120V/15A	1	157300
	778141	GFCI Cord 120V/ 20A	1	157301
	778142	GFCI Cord, 240V/30A	1	157302
	777616	Motor, 1.5 HP Leeson	1	157300
25	777617	Motor, 2.0 HP Leeson	1	157301
	778670	Motor, 5.0 HP Leeson	1	157302
	779402	Pump, Comet BXD 1617E	1	157300
26	778154	Pump, Cat 2DX	1	157301
	38518	Pump, Cat 3DX	1	157302
	38584	3/8" NPT Easy Start Valve	1	157302
27	38584	3/8" NPT Easy Start Valve	1	157302
28	777347	6MP-6FP-6FP Tee Forged	1	157302
29	777915	QC 3/8" Female Nipple	1	157301,2
30	35918	Thermal Protector	1	157301,2
31	38596	Inlet Filter	1	157301,2
32	777340	1/4 MPT x 1/4 Hose Barb	1	157302
33	777834	Hose Clamp - 1/4"	2	157302
34	777165	1/4" Braided Bypass Hose	1 ft	157302
35	777855	Toggle Switch	1	All
	5260	On-Off Plate	1	All
36	38527	Gun, Consumer, QC	1	157301,2
37	313107	3/8" Male NPT Coupler	1	157301,2
38	38526	Gun, 2700 PSI, 22mm	1	157300
39	778070	Cord Warning	1	All
40	778151	DP Contactor 120V/25A	1	157301
	778152	DP Contactor 230V/30A	1	157302

ITEM NUMBERS:

157300, 157301  
157302

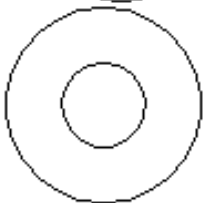
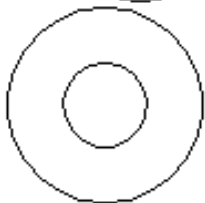
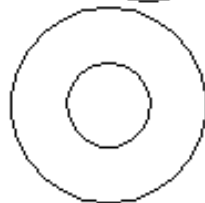
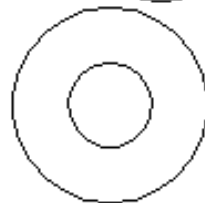
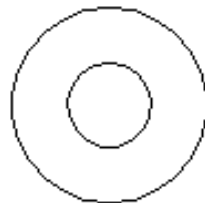
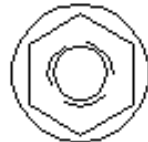
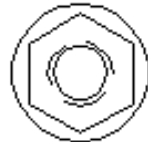
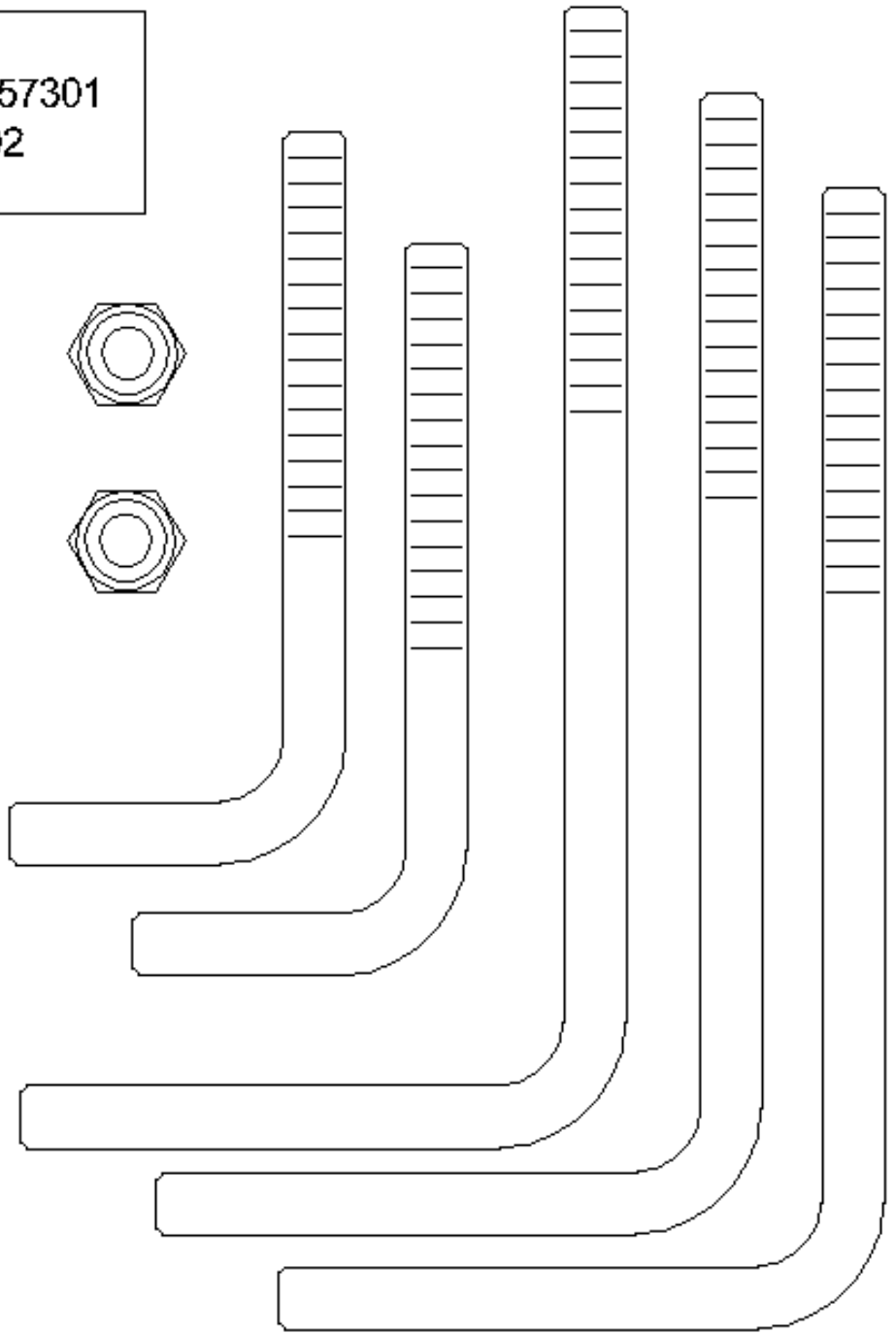
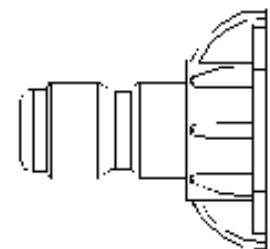
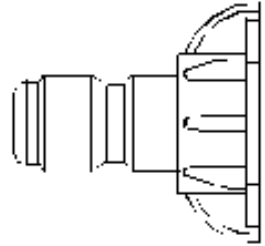
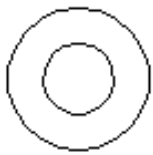
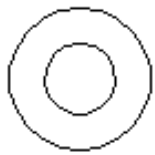
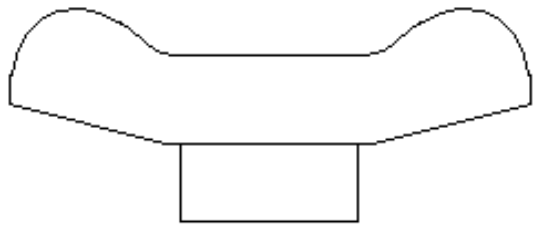
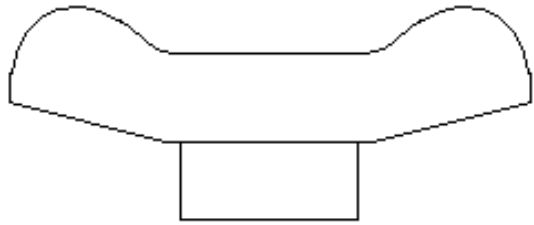
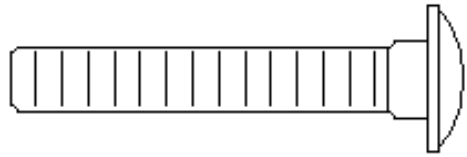
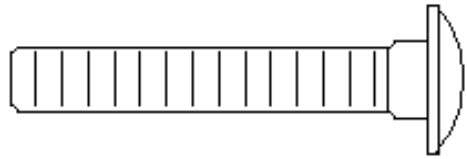

1.0279