

08.01.2007



Nilfisk-ALTO C 120.1



Nilfisk ALTO

Why Compromise

Ⓒ User manual

**Wap
KEW**

TECHNOLOGIES

1	Safety precautions and warnings	3
2	Description	4
3	Before you start using your pressure washer	5
4	Operating your pressure washer	6
5	Fields of Application and Working Methods.....	8
6	After using your pressure washer	10
7	Maintenance.....	11
8	Trouble Shooting	13
9	Further information.....	14
10	EC Declaration of Conformity.....	16

1 Safety Precautions and Warnings

Symbols used to mark instructions



Before starting up your high-pressure washer for the first time, this instruction manual must be read through carefully. Save the instructions for later use.



Safety instructions marked with this symbol must be observed to prevent danger to persons.



This symbol is used to mark safety instructions that must be observed to prevent damage to the machine and its performance.



This symbol indicates tips and instructions to simplify work and to ensure a safe operation.



Do not let children or people who have not read the instruction manual operate the machine.

Before starting up your machine please check it carefully for any defects. If you find any, do not start up your machine and contact your ALTO distributor.

Especially check:

- The insulation of the electric cable should be faultless and without any cracks. If the electric cable is damaged, an authorized Nilfisk-ALTO distributor should replace it.

WARNING!

- High pressure jets can be dangerous. Never direct the water jet at persons, pets, live electrical equipment or the machine itself.
- Never try to clean clothes or footwear on yourself or other persons.
- Hold the spray lance firmly with both hands. The spray lance is affected by a thrust of up to 26.5 Nm during operation.
- The operator and anyone in the immediate vicinity of the site of cleaning should take action to protect themselves from being struck by debris dislodged during operation. Wear goggles during operation.

- Never use the machine in an environment where there could be a danger of explosion. If any doubt arises, please contact the local authorities.
- It is not allowed to clean asbestos-containing surfaces with high pressure.
- This high pressure washer must not be used at temperatures below 0°C.
- Never let any persons stay under the product when stored on the wall.

WARNING!

Inadequate extension cables can be dangerous. Cables on drums should always be completely unwinded to prevent the cable from overheating.

Extension cables should be of a watertight construction and comply with the below-mentioned requirements for length and cable dimensions.

1.0 mm ²	max.	12.5 m
1.5 mm ²	max.	20 m
2.5 mm ²	max.	30 m

- Cable connections should be kept dry and off the ground.

Mains power connection



The following should be observed when connecting the high pressure washer to the electric installation:

- Only connect the machine to an installation with earth connection.
- The electric installation shall be made by a certified electrician.
- It is strongly recommended that the electric supply to this machine should include a residual current device (GFCI).

Water connection

Connection to the public mains according to regulations.

IMPORTANT! Only use water without any impurities. If there is a risk of running sands in the inlet water (i.e. from your own well), an additional filter should be mounted.

Repair and maintenance

Always remove the electric plug from the socket before carrying out maintenance work on the machine.

Safety devices

Locking device on spray gun (7a) (see foldout at the end of this manual):

The spray gun features a locking device. When the pawl is activated, the spray gun cannot be operated.

Thermal sensor:

A thermal sensor protects the motor against overloading. The machine will restart after a few minutes when the thermal sensor has cooled.

2 Description

2.1 Application

This high-pressure washer has been developed for domestic use within:

- Car, Motorbike, boat, caravan, trailer, patio/drive/flags-tones, woodwork, brickwork, barbecue, garden furniture, lawn mower

Section 5 describes the use of

the high-pressure washer for various cleaning jobs.

Only use the high-pressure washer for purposes described in this manual.

The safety precautions must be observed to prevent damage to the machine, the surface to be cleaned or severe personal injuries.

2.2 Operation elements and model survey



See foldout at the end of this manual.

- 1 Start/stop switch
- 2 Water inlet (with filter)
- 3 High pressure connection
- 4 High pressure hose
- 5 Electric cable
- 6 Click & Clean spray lance
- 7 Spray gun with lock
- 8 Click & Clean Tornado® PR nozzle
- 9 Click & Clean Powerspeed® nozzle
- 10 Click & Clean foam sprayer

- 11 Nozzle cleaning tool
- 12 Trolley Handle
- 13 Hose reel (not standard)
- 14 Hose hook
- 15 Model tag

Specifications: See model tag (15) of machine.

Sound pressure level measured in accordance with ISO 3744, EEC Directive 2000/14/EEC: L_{pA} = 71.3 dB(A), L_{WA} = 86 dB(A).

We reserve the right to alter the specifications.

3 Before you start using your pressure washer



3.1 Mounting of trolley handle (models with trolley handle)

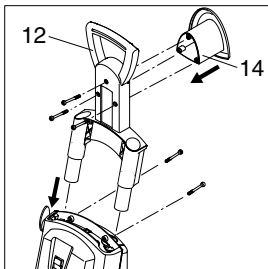

1. Remove the label on top of machine.
2. Push down the trolley handle (12) into the machine. Secure the handle by tightening the 2 screws.
3. Mount the hose hook (14) on the handle (3 screws).
Note: the hose hook can be mounted on the front as well as on the back. Front position is to be used if the product is used together with a special wall hook for wall storage.

3.2 Mounting of hose reel handle

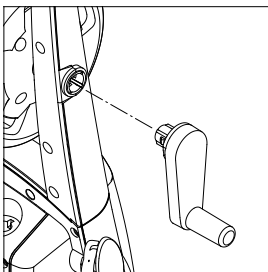

1. Click the hose reel handle on to the trolley handle (no screws).

3.3 Mounting of quick coupling

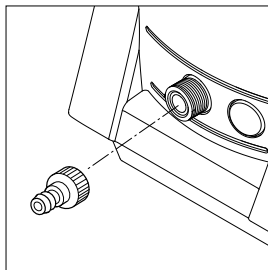

1. Screw the quick coupling tight on to the water inlet (2).
Note: The inlet filter must always be fitted in the water inlet pipe to filter out sand, limestone and other impurities as these will damage the pump valves.



Caution: Failure to fit the filter will invalidate the guarantee.

GB

3.4 Mounting of high pressure hose

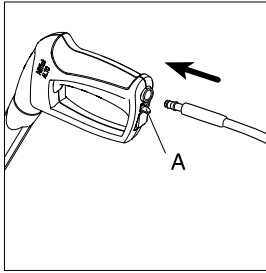

Attach the high pressure hose (4) to the spray gun (7).

Detach the high pressure hose by pressing the pawl (A).

4 Operating your pressure washer

4.1 Connection of high pressure hose

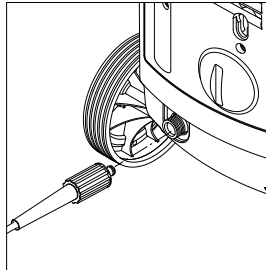

1. Mount the high pressure hose on the outlet (3).

4.2 Mounting of spray lance and Click & Clean nozzles

1. Push the spray lance (6) into the spray gun (7) and screw it on.

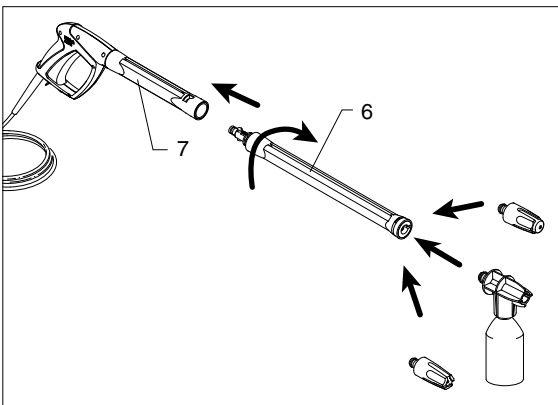

 **Note:** The spray lance (6) has a built-in low pressure nozzle that can be used for flushing away dirt.

2. Attach the nozzle.

 **Warning:** When attaching the Click & Clean nozzles, the pawl on the side of the spray lance should come out again.

 **Note:** The Tornado® PR nozzle and the foam sprayer feature a swivel lock, which must be positioned in the hole in the Click & Clean spray lance.

Press the pawl to detach the Click & Clean nozzle.

4.3 Water connection

An ordinary 1/2" garden hose of **min. 5 m** and **max. 25 m** will be suitable.

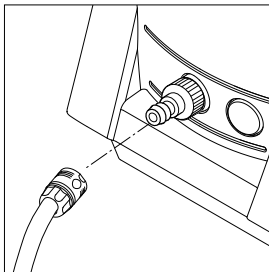

NOTE: Connection to the public mains according to regulations.

IMPORTANT! Only use water without any impurities. If there is a risk of running sands in the inlet water (i.e. from your own well), an additional filter should be mounted.

1. Let the water run through the water hose before connecting it to the machine to prevent sand and dirt from penetrating the machine.

Note: Check that the filter is fitted in the water inlet pipe and that it is not clogged up.

2. Connect the water hose to the water supply by means of the quick connector (inlet water, max. pressure: 10 bar, max. temperature: 50°C).
3. Turn on the water.

4.4 Start and stop of the machine (when connected to a water supply)



The machine must not be operated while hanging on the wall hook!

The spray lance is affected by a thrust during operation - therefore always hold it firmly with both hands. **IMPORTANT: Point the nozzle at the ground.**

1. Check that the machine is in upright position.

NOTE: Do not place the machine in high grass!

2. Release the trigger lock.
3. Activate the trigger of the spray gun and let the water run until all air has escaped from the water hose.
4. Press the Start/stop switch "I" (1).
5. Activate the trigger of the spray gun.

Always adjust the distance and thus the pressure of the nozzle to the surface, which is to be cleaned.

Do not cover the machine during operation.



Note: If the machine is left or not used for 5 minutes, it must be switched off on the start/stop switch "O" (1):

1. Press the start/stop switch "O".
2. Disconnect the electrical plug from the socket.
3. Shut off the water supply and activate the trigger to relieve the machine of pressure.
4. Lock the spray gun.

When releasing the trigger of the spray gun, the machine automatically stops. The machine will start again when you re-activate the spray gun.

4.5 Start the machine (when connected to open containers (suction mode))

The washer can take in water from a rain water tank as an example. The hose for the water supply must not be too long, approx. 5 m.

Make sure that the water tank is not placed on a lower level than the machine.

1. Place the other end of the water hose in the water tank. Use an external filter if the water contains impurities.
2. Press the start/stop switch "I".
3. Activate the trigger of the spray gun and let the water run, until the air has escaped from the water hose and the pump.
4. Mount spray lance and nozzle.

4.6 Pressure regulation on the TORNADO® PR-nozzle

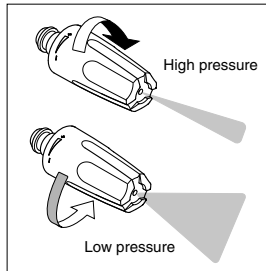

The pressure can be regulated on the TORNADO® PR nozzle.

5 Fields of application and working methods

5.1 General

Efficient high pressure cleaning is achieved by following a few guidelines, combined with your own personal experience of specific cleaning tasks. Accessories and detergents, when correctly chosen, can increase the efficiency of your pressure washer. Here is some basic information about cleaning.

5.1.1 Detergent and foam

Foam or detergent should be applied onto dry surfaces so that the chemical product is in direct contact with the dirt. Detergents are applied from bottom to top, for example on a car bodywork, in order to avoid "super clean" areas, where the detergent collects in higher concentration and streams downwards. Let the detergent work for several minutes before rinsing but never let it dry on the surface being cleaned. **Note:** It is important that the detergents do not dry up. Otherwise the surface that has to be cleaned can be damaged.

5.1.2 Mechanical effect

In order to break down tough layers of dirt, additional mechanical effect may be required. Special wash brushes offer this supplementary effect that cuts through dirt (especially by car washing).

5.2 Typical fields of application



Below you will find a description of a lot of cleaning tasks which can be solved by a pressure washer from Nilfisk-ALTO in association with accessories and detergents.

Task	Accessories 'Click & Clean'	Cleaning method
Car	Car nozzle, auto brush, underchassis nozzle, Foam sprayer, Car Combi Cleaner	<ol style="list-style-type: none"> 1. Apply Car Combi Cleaner with the foam sprayer. Always start from the bottom and work upwards. Let Car Combi Cleaner act for at least 5 min. 2. Wash the car with the car nozzle, which has been optimized for quick and gentle cleaning of enamelled surfaces (the jet is wider and not so sharp). Start at the front of the car and work backwards to avoid water from penetrating by the door mouldings. 3. Use the brush for removal of traffic film which is not removed by the nozzle. If the car is very dirty, apply Car Combi Cleaner again. 4. Attach the undercarriage nozzle and clean undercarriage and wheel arches. 5. Remove water from the surface of the car with the scraper on the car brush. Make sure that all grains of sand etc. have been removed before using the scraper. Wipe with a wash leather where the scraper cannot reach.
Rims, aluminium	Rim brush, auto nozzle, atomizer, Alu Cleaner	Apply Alu Cleaner with an atomizer. Let it act for approx. 5 min. and wash with the rim brush. For steel rims, use Car Combi Cleaner. Use the foam sprayer and wash with rim brush. Be careful! The high pressure jet may damage the tyres.
Flagstones, concrete floors and other hard surfaces	Powerspeed® nozzle, Stone & Wood Cleaner, Patio Cleaner	Wash towards outlets or the like. On surfaces with moss or algae you may start by applying Stone & Wood Cleaner with the foam sprayer. Wash before the soap dries. Another more effective and quicker method is to use the Patio Cleaner. Thus you will also avoid splashes.
Garden furniture, wood	Wood Cleaner Garden brush	Apply Wood Cleaner and wash before the soap dries. NOTE: Use the garden brush to clean off the dirt.
Brickwork, Wood work	Powerspeed® nozzle, Stone & Wood Cleaner, Patio Cleaner	Same method as for flagstones, but be careful - bad joints and wood may be damaged by high pressure. You may choose only to use the Tornado® nozzle. Adjust the distance (pressure) to the quality of the joints and the wood. Patio Cleaner can also be used on vertical surfaces.
Gutter	Underchassis spray lance	Wash the gutter with the nozzle. Always wash towards downpipes. Beware not to spray under the roofing.
Cleaning of drain pipes, outlets, down pipes etc.	Tube cleaner	Push the tube cleaner approx. ½ m (to mark) into a tube or drain and activate the trigger of the spray handle. The nozzle opening turning backwards will pull the cleaner through the tube. The nozzle will break down the „plug“ and flush the dirt backwards.
Rust, paint	Water/sandblasting equipment	Mount the water/sand blasting equipment and rust and paint is efficiently and quickly removed. Beware not to damage the surface to be sandblasted.
Greenhouse	Tornado® PR nozzle brush, Stone & Wood Cleaner	Wash with high pressure and maybe a brush. You may use Stone & Wood Cleaner to remove moss and algae.
Garden tools, lawn mover	Tornado® PR nozzle, Powerspeed® nozzle, multiangle adaptor, Metal Cleaner	Rinse the worst dirt off with the nozzle. Apply Metal Cleaner with the foam sprayer and let it act for approx. 5 min. Wash with the nozzle. You may use the multiangle adaptor for hard to get at areas to avoid splashing.

6 After using your pressure washer

6.1 Storing the washer



The machine should be stored in a frost-free room!

Pump, hose and accessories should always be emptied of water prior to storing as follows:

1. Stop the machine (press the start/stop switch "O" (1) and detach water hose and accessory).
2. Restart the machine and activate the trigger. Let the machine run until no more water runs through the spray gun.

3. Stop the machine, unplug and wind up hose and cable.
4. Place spray handle, nozzles and other accessories in the holders of the machine.

Should the machine by mistake be frozen, it will be necessary to check it for damage.

NEVER START-UP A FROZEN MACHINE.

Frost damages are not covered by the guarantee!

6.2 Winding up of electric cable and high pressure hose

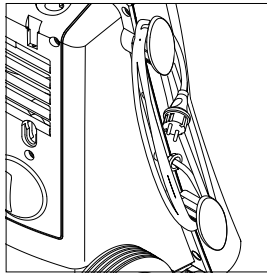

To avoid accidents, the electric cable and the high pressure hose should always be wound carefully up.

1. Wind up the electric cable on the appropriate hooks.

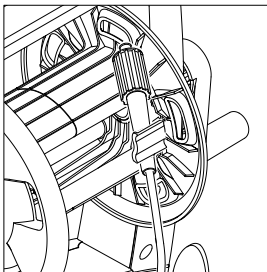

The high pressure washer comes in two models: A) with hook for storage of high pressure hose (14) - B) with a hose reel (13), where the hose is pushed into the reel and afterwards wound up.

6.3 Storage of accessories

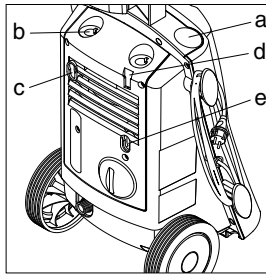

The standard accessories (spray gun and spray lance (a), nozzles (b) foam sprayer (c)) can be stored on the pressure washer. The nozzle cleaning tool (d) and a Click & Clean brush (e) can also be stored on the product.



6.4 Wall storage

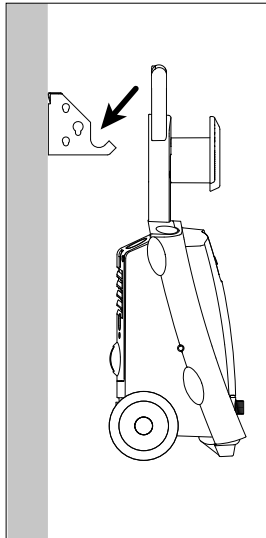
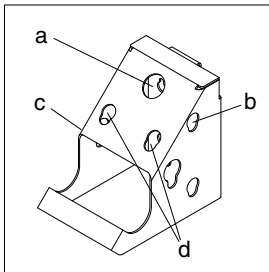

The pressure washer can be stored on a wall on a special wall hook (not standard).

Only mount the wall hook on a sturdy wall. Adjust the length of the screws and size of rawl-plugs to the type of wall.

On the wall hook garden/rim brush (a) foam sprayer (b), Click & Clean brush (c) and Click & Clean nozzles (d) can be stored.



Note: For this product the wall hook can only be used as storage.



Important: The bearing capacity of the wall hook is max. 30 kg.

7 Maintenance



WARNING! Always disconnect the electrical plug from the socket prior to maintenance or cleaning.

To ensure a long and problem free working life, please take the following advice:

- Wash out water hose, high pressure hose, spray lance and accessories before mounting.
- Clean the connectors of dust and sand.

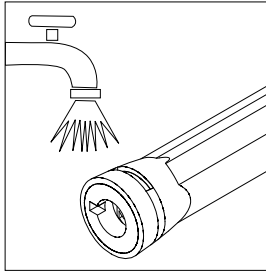

- Make sure that no sand or dirt is blocking the movement of the pawl on the Click & Clean spray lance. Rinse according to requirement.
- Rinse the detergent spraying attachment after use.
- Clean the nozzles.

Any repair should always be made in an authorized workshop with original spare parts.

7.1 Cleaning of water inlet filter

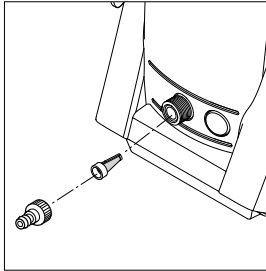

Clean the water inlet filter regularly once a month or more frequently according to use. Carefully loosen the filter with a screwdriver and clean it. Check that it is intact before re-mounting it.

The inlet filter must always be fitted inside the water inlet pipe to filter out sand, limestone and other impurities, as they will damage the pump valves.

CAUTION: Failure to fit the filter will invalidate the guarantee.

7.2 Cleaning of nozzle

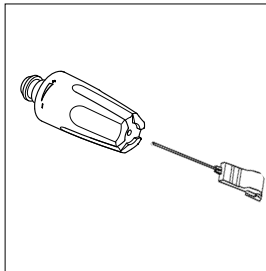

A clogging up in the nozzle causes a pump pressure which is too high. This is why cleaning is required immediately.

1. Stop the machine and disconnect the nozzle.
2. Clean the nozzle. **IMPORTANT:** The cleaning tool (11) should only be used when the nozzle is detached!
3. Flush the nozzle backwards with water.

7.3 Cleaning of machine vents

The machine should be kept clean so as to let cooling air pass freely through the machine vents.

7.4 Greasing of couplings

To ensure an easy connection and that o-rings do not dry up, the couplings should be greased regularly.

8 Trouble-shooting



To avoid unnecessary disappointments, you should check the following before contacting the Nilfisk-ALTO service organization:

Symptom	Cause	Recommended action
Machine refuses to start	Machine not plugged in Defective socket Fuse has blown Defective extension cable	Plug in machine. Try another socket. Replace fuse. Switch off other machines. Try without the extension cable.
Fluctuating pressure	Pump sucking air Valves dirty, worn out or stuck Pump seals worn out	Check that hoses and connections are air-tight. Clean and replace or refer to local Nilfisk ALTO distributor Clean and replace or refer to local Nilfisk-ALTO distributor.
Motor busses	Low voltage or low temperature	Activate the trigger of the spray gun.
Machine stops	Fuse has blown Incorrect mains voltage Thermal sensor activated Nozzle partially blocked	Replace fuse. Switch off other machines. Check that the mains voltage corresponds to specification on the model tag. Leave the washer for 5 minutes to cool down. Clean the nozzle (see section 7.2)
Fuse blows	Fuse too small	Change to an installation higher than the amp. consumption of the machine. You may try without the extension cable.
Machine pulsating	Air in inlet hose/pump Inadequate supply of mains water Nozzle partially blocked Water filter blocked Hose kinked	Allow machine to run with open trigger until regular working pressure resumes. Check that the water supply corresponds to specifications required (see model tag) NB! Avoid using long, thin hoses (min. 1/2") Clean the nozzle (see section 7.2) Clean the filter (see section 7.1) Straighten out hose.
Machine often starts and stops by itself	Pump/spray gun is leaking	Contact your nearest Nilfisk-ALTO Service Centre.
Machine starts, but no water comes out	Pump/hoses or accessory frozen No water supply Water filter blocked Nozzle blocked	Wait for pump/hoses or accessory to thaw. Connect inlet water. Clean the filter (see section 7.1) Clean the nozzle (see section 7.2)

In case problems other than the above occur, please contact your local Nilfisk-ALTO distributor.

9 Further information

9.1 Recycling the washer

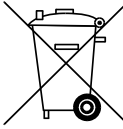

Make the old cleaner unusable immediately.

1. Unplug the cleaner and cut the electric cable.

Do not discard electrical appliances with household waste.

As specified in European Directive 2002/96/EC on old electrical and electronic appliances, used electrical goods must be collected separately and recycled ecologically.

Contact your local authorities or your nearest dealer for further information.

9.2 Warranty conditions

Nilfisk-ALTO guarantees high pressure washers for domestic use for 2 years. If your high pressure washer or accessories are handed in for repair, a copy of the receipt must be enclosed. Guarantee repairs are being made on the following conditions:

- that defects are attributable to flaws or defects in materials or workmanship. (wear and tear as well as misuse are not covered by the guarantee).
- that the directions of this instruction manual have been thoroughly observed.
- that repair has not been carried out or attempted by other than Nilfisk-ALTO-trained service staff.
- that only original accessories have been applied.
- that the product has not been exposed to abuse such as knocks, bumps or frost.
- that only water without any impurities has been used.
- that the high pressure washer has not been used for rental nor used commercially in any other way.

Repairs under this guarantee include replacement of defective parts, exclusive of packing and postage/carriage. Besides, we refer to your national law of sale.

The machine should be forwarded to one of the service centres of the Nilfisk-ALTO organisation with description/specification of the fault.













Repairs not covered by the guarantee conditions will be invoiced. (I.e. malfunctions due to **Causes** mentioned in section **Troubleshooting Chart** of the instruction manual).

In order that Nilfisk-ALTO can render you optimum service, you should register your product on our web site www.nilfisk-alto.com under "PRODUCT REGISTRATION".

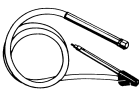
9.3 Accessories





Only use original accessories.

Click & Clean Car nozzle		Special nozzle for enameled surfaces. Optimal distance: 30 - 50 cm.
Click & Clean Undershassis nozzle		90° angled special nozzle for undercarriage and wheel arches. Integrated guide shoes.
Click & Clean Multiangle adaptor		Adjusted in angles from 0° - 90° for better working posture and cleaning of hard to get at places as for instance barrels or the underside of the lawn mower. Fits all nozzles.
Click & Clean Brushes		For cars and other surfaces. Available in more shapes.
Extension hose		7 m extension hose increasing the working range.
Underchassis spray lance		Special spray lance for washing your car underneath.
Drain & Tube cleaner		15 m long tube cleaner for the cleaning of tubes and drains.
Water-sand-blasting equipment		For removal of paint and rust. Sand available from do-it-yourself shops.
Patio Cleaner		Equipment for quick cleaning of patio/drive/flagstones.
Garden brush		Rotary brush for cleaning of wooden surfaces.
Rim brush		Rotary brush for cleaning of wheel rims.
Wall hook		For suspension of your high pressure washer on the wall.
Rotary brush		For cleaning vehicles and other surfaces.

Detergents

Stone & Wood Cleaner	For flagstones, brick- and woodwork. Suitable for moss and algae.
Plastic Cleaner	For plastic and synthetic materials such as garden furniture.
Metal Cleaner	For cleaning of metal such as garden tools.
Car Combi Cleaner	For cars etc. With rinsing wax.
Alu Cleaner	For surfaces of aluminium. Applied with an atomizer.
Oil & Grease Cleaner	For cleaning of grease and oil on motors for instance. Applied with an atomizer.
Wood Cleaner	For cleaning of wooden surfaces incl. of wooden garden furniture.

10 EU Declaration of Conformity

		EU Declaration of Conformity	
Product:	High Pressure Washer		
Type:	Nilfisk-ALTO C 120.1-6 / C 120.1-10		
Description:	230 V 1~, 50 Hz - IP X5		
The design of the unit corresponds to the following pertinent regulations:	EC Machine Directive	98/37/EC	
	EC Low-voltage Directive	73/23/EEC	
	EC EMV Directive	2004/108/EEC	
Applied harmonised standards:	EN 60335-2-79		
Applied national standards and technical specifications:	IEC 60335-2-79		
	Nilfisk-ALTO		
	Division of Nilfisk-Advance A/S		
	Industrivej 1		
	DK-9560 Hadsund		
 Anton Sørensen V.P. Technical Operations Europe	Hadsund, 01.11.2004		

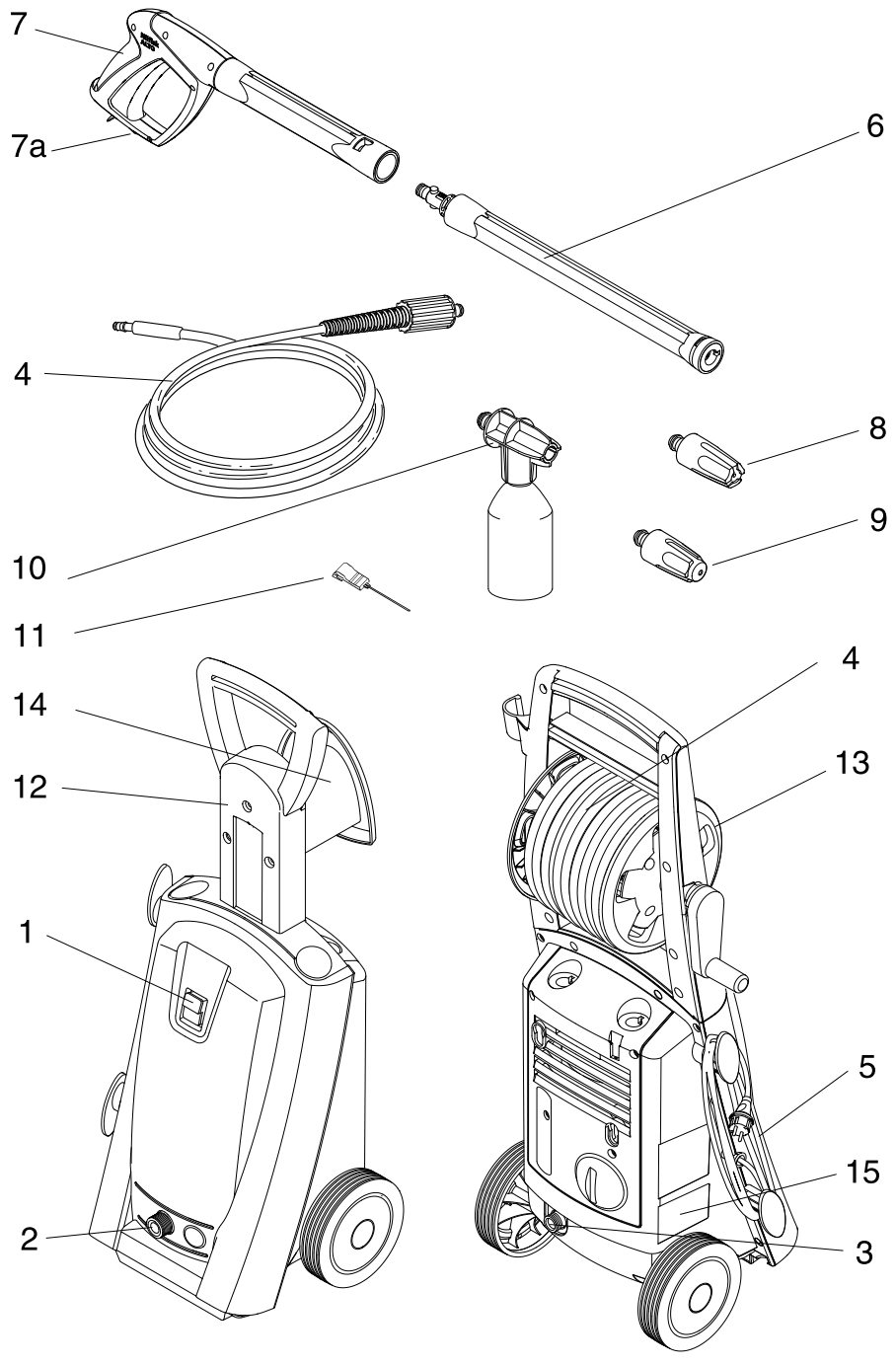

Nilfisk ALTO

Why Compromise

<http://www.nilfisk-alto.com>

HEAD QUARTER

DENMARK

Nilfisk-Advance Group
Sognevej 25
DK-2605 Brøndby
Tel.: +45 4323 8100
Fax: +45 4343 7700
E-mail: mail@nilfisk-advance.dk

SALES COMPANIES

AUSTRALIA

Nilfisk-ALTO
48 Egerton St.
P.O. Box 6046
Silverwater, N.S.W. 2128
Tel.: +61 2 8748 5966
Fax: +61 2 8748 5960

AUSTRIA

Nilfisk-Advance GmbH
Nilfisk-ALTO
Metzgerstrasse 68
5101 Berghem/Salzburg
Tel.: +43 662 456 400-0
Fax: +43 662 456 400-34
E-mail: info@nilfisk-alto.at
www.nilfisk-alto.at

BELGIUM

Nilfisk-ALTO
Division of Nilfisk-Advance n.v.s.a.
Dornveld/Sphere Business Park
Industrie Asse 1 Zellik-Asse
Tel.: +32 02 467 60 50
Fax: +32 02 466 61 50
E-mail: info.be-@nilfisk-alto.com

CANADA

Clarke Canada
Part of the Nilfisk-Advance Group
4080 B Sladeview Crescent, Unit 1
Mississauga, Ontario L5L 5Y5
Tel.: +1 905 569 0266
Fax: +1 905 569 8586

CHINA

Nilfisk-Advance (Shenzhen) Ltd.
Blok 3, Unit 130 1001 Honghua Road
Int. Commercial & Trade Ce nter
Futian Free Trade Zone
518038 Shenzhen
Tel.: +86 755 8359 7937
Fax: +86 755 8359 1063

CZECH REPUBLIC

ALTO Česká Republika s.r.o.
Zateckých 9
14000 Praha 4
Tel.: +420 24 14 08 419
Fax: +420 24 14 08 439
E-mail: wap_p@mbox.vol.cz

DENMARK

Nilfisk-ALTO
Division of Nilfisk-Advance A/S
Industrivej 1
9560 Hadsund
Tel.: +45 7218 2100
Fax: +45 7218 2105
E-mail: salg@nilfisk-alto.dk
E-mail: service@nilfisk-alto.dk
www.nilfisk-alto.dk

Nilfisk-ALTO Food division
Division of Nilfisk-Advance A/S
Blytækkervej 2
9000 Aalborg
Tel.: +45 7218 2100
Fax: +45 7218 2099
E-mail: scantio.technology@nilfisk-alto.dk

FRANCE

Nilfisk-ALTO
ALTO France SAS
Aéroparc 1
19 rue Icare
67960 Entzheim
Tel.: +33 3 88 28 84 00
Fax: +33 3 88 30 05 00
E-mail: info@nilfisk-alto.fr
www.nilfisk-alto.com

GERMANY

Nilfisk-ALTO
Division of Nilfisk-Advance AG
Guido-Oberdorfer-Strasse 10
89287 Bellenberg
Tel.: +49 0180 5 37 37 37
Fax: +49 0180 5 37 37 38
E-mail: info@nilfisk-alto.de
www.nilfisk-alto.de

GREECE

Nilfisk-Advance SA
8, Thoukididou str.
164 52 Argiroupolis
Tel.: +30 210 96 33443
Fax: +30 210 96 52187
E-mail: nilfisk-advance@clean.gr

HOLLAND

Nilfisk-ALTO
Division of Nilfisk-Advance BV
Camerastraat 9
3322 BB Almere
Tel.: +31 36 546 07 60
Fax: +31 36 546 07 61
E-mail: info@nilfisk-alto.nl
www.nilfisk-alto.nl

HONG KONG

Nilfisk-Advance Ltd.
2001 HK Worsted Mills Ind'l Bldg.
31-39 Wo Tong Tsui St.
Kwai Chung
Tel.: +852 2427 5951
Fax: +852 2487 5828

HUNGARY

Nilfisk-Advance Kereskedelmi Kft.
II. Rákóczi Ferenc út 10
2310 Szigetszentmiklos-Lakihegy
Tel.: +36 2447 5550
Fax: +36 2447 5551
E-mail: info@nilfisk-advance.hu
www.nilfisk-advance.hu

ITALY

Nilfisk-ALTO
Divisione di Nilfisk-Advance A/S
Località Novella Terza
26862 Guardamiglio (LO)
E-mail: d.puglia@nilfisk-advance.it

JAPAN

Nilfisk-Advance Inc.
247 Nippa-cho, Kouhoku-ku
Yokohama, 223-0057
Tel.: +8145 548 2571
Fax: +8145 548 2541

MALAYSIA

Nilfisk-Advance Sdn Bhd
Sd 14, Jalan KIP 11
Taman Perindustrian KIP
Sri Damansara
52200 Kuala Lumpur
Tel.: +60 3 603 6275 3120
Fax: +60 3 603 6274 6318

NORWAY

Nilfisk-Advance AS
Bjørnerudveien 24
1266 Oslo
Tel.: +47 22 75 17 70
Fax: +47 22 75 17 71
E-mail: info@nilfisk-alto.no
www.nilfisk-alto.no

POLAND

Nilfisk-Advance Sp. Z.O.O.
05-800 Pruszków
ul. 3-go MAJA 8
Tel.: +48 22 739 37 50
Fax: +48 22 738 37 51
E-mail: info@nilfisk-alto.pl
www.nilfisk-alto.pl

PORTUGAL

Nilfisk-ALTO
Division of Nilfisk-Advance Lda.
Sintra Business Park
Zona Industrial Da Abrunheira
Edificio 1, 1º A
P2710-089 Sintra
Tel.: +35 808 200 537
Fax: +35 121 911 2679
E-mail: mkt@nilfisk-advance.es

RUSSIA

Nilfisk-Advance LLC
Vyatskaya str., 27, bld. 7
127015 Moscow
Tel.: +7 495 783 96 02
Fax: +7 495 783 96 03
E-mail: info@nilfisk-advance.ru

SINGAPORE

Nilfisk-Advance Pte. Ltd.
Nilfisk-ALTO Division
40 Loyang Drive
Singapore 508961
Tel.: +65 6 759 9100
Fax: +65 6 759 9133
E-mail: sales@nilfisk-advance.com.sg

SPAIN

Nilfisk-ALTO
Division of Nilfisk-Advance S.A.
Torre D'Ara
Paseo del Rengle, 5 Pl. 10
08302 Mataró
Tel.: +3 4 902 200 201
Fax: +34 93 757 8020
E-mail: mkt@nilfisk-advance.es

SWEDEN

ALTO Sverige AB
Member of Nilfisk-Advance Group
Aminogatan 18, Box 4029
431 04 Mölndal
Tel.: +46 31 706 73 00
Fax: +46 31 706 0@nilfisk-alto.se
www.nilfisk-alto.se

TAIWAN

Nilfisk-Advance Taiwan Branch
No. 5, Wan Fang Road
Taipei
Tel.: +886 227 002 268
Fax: +886 227 840 843

THAILAND

Nilfisk-Advance Co. Ltd.
89 Soi Chokechai-Ruammitr
Viphavadee-Rangsit Road
Layao, Jatuchak, Bangkok 10900
Tel.: +66 2 275 5630
Fax: +66 2 691 4079

TURKEY

Nilfisk-Advance Profesyonel Temizlik
Ekipmanlari Tic. A/S.
Nekpa Cad. No.: 48
Yenisahra / Kadiköy
Istanbul
Tel.: +90 216 470 08 - 60
Fax: +90 216 470 08 - 63
www.nilfisk-advance.com

UNITED KINGDOM

Nilfisk-ALTO
Division of Nilfisk-Advance Ltd.
Bowerbank Way
Gillwilly Industrial Estate, Penrith
Cumbria CA11 9BG
Tel.: +44 1 768 86 89 95
Fax: +44 1 768 86 47 13
E-mail: sales@nilfisk-alto.co.uk
www.nilfisk-alto.co.uk

USA

ALTO Cleaning Systems Inc.
Part of the Nilfisk-Advance Group
12249 Nations Ford Rd.
Pineville, North Carolina 28134
Tel.: +1 704 971 1240
Fax: +1 704 971 1241
E-mail: info@nilfisk-advance.us

VIETNAM

Nilfisk-Advance Representative Office
No. 46 Doc Ngu Str.
Ba Dinh Dist.
Hanoi
Tel.: +84 4 761 5642
Fax: +84 4 761 5643
E-mail: [Nilfisk@vnn.vn](mailto:nilfisk@vnn.vn)