

K12 Surface Cleaner

High Pressure Washer Accessory

Overview	1
Precautions	1-2
Assembly Instructions	3
Operating Controls	4
Normal Operating Settings	5
Parts List	6

**In USA Call:
1-800-537-4129
or visit our website:
www.karcher-usa.com**



K12 SURFACE CLEANER OVERVIEW

Item Description

1. Housing
2. Pressure nozzles (gray) from 1200 - 1600 PSI
3. Pressure nozzles (yellow) from 1700 - 2300 PSI
4. Handle (2 piece)
5. Hand grip
6. Nozzle height adjustment
7. Air flow control (hovering effect)

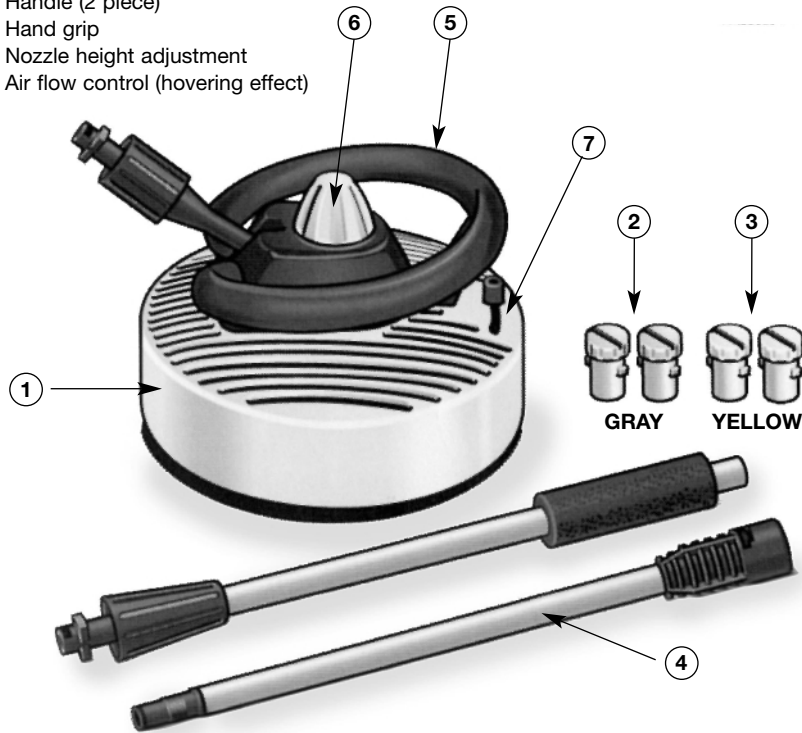

IMPORTANT PRECAUTIONS – Read First!

! Safety Warnings

When using this product, basic precautions should always be followed:

- Read all the instructions before using the product.
- High pressure jets can be dangerous if subject to misuse. The jet must not be directed at persons, animals, electrical devices, or the machine itself.
- Wear safety goggles. 
- Keep hands away from moving parts.
- Do not use acids, alkalines, solvents, or any flammable material in this product. These products can cause physical injuries to the operator and irreversible damage to the machine.
- Stay alert — watch what you are doing.
- Do not operate the product when fatigued or under the influence of alcohol or drugs.
- Do not stand on unstable surfaces. Stand with both feet balanced at all times.
- The Gun Safety Lock PREVENTS the trigger from accidentally being engaged. This safety feature DOES NOT lock trigger in the on position.

Water Supply (Cold Water Only)

- Water hose must be at least 3/4 inch in diameter.
- Flow rate of water supply must not fall below 2.5 GPM (gallons per minute).
- Flow rate can be determined by running the water for one minute into an empty 5-gallon container.
- The water supply temperature must not exceed 104°F/40°C.
- Never use the pressure washer to draw in water contaminated with solvents, e.g. paint thinners, gasoline, oil, etc.
- Always prevent debris from being drawn into the unit by using a clean water source.

! WARNING

TO AVOID SERIOUS INJURY, NEVER POINT SPRAY NOZZLE AT YOURSELF, OTHER PERSONS OR ANIMALS.

! CAUTION

- Follow the maintenance instructions specified in the manual.
- This machine has been designed for use with cleaning detergents supplied or recommended by the manufacturer. The use of other cleaning detergents may affect the operation of the machine and void the warranty.
- Keep hands away from moving parts

Never use:

- Bleach, Chlorine products and other corrosive chemicals
- Liquids containing solvents (i.e., paint thinners, gasoline, oils)
- Tri-sodium phosphate products
- Ammonia products
- Acid-based products. These chemicals will harm the unit and will damage the surface being cleaned.

Please Note:

- For optimum setting test the spray power in an unseen area.
- Never operate in the same area for more than 2 seconds, damage may occur
- Do not use on windows..

NEVER!

- Never** point nozzle at people or animals.
- Never** drink alcohol or use drugs while operating this equipment.
- Never** spray electrical connections, electrical outlets or fixtures.
- Never** touch hot surfaces or allow accessories to contact hot surfaces.
- Never** operate pressure washer without the water turned on.
- Never** use hot water.

In USA Call:
1-800-537-4129
 or visit our website: www.karcher-usa.com

ASSEMBLY INSTRUCTIONS

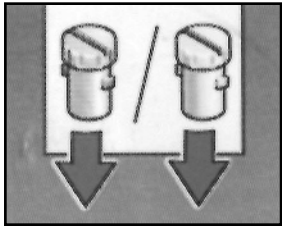

GRAY YELLOW

Step 1 Determine the PSI of your pressure washer.

1200 – 1600 PSI, Select the gray nozzles

1700 – 2300 PSI, Select the yellow nozzles.

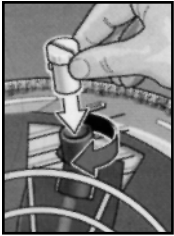

Step 2 Insert the 2 matching pressure nozzles in the slots on the propeller.

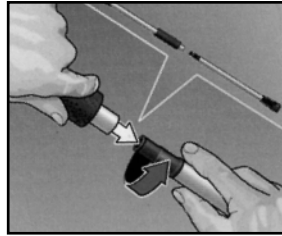

Step 3 Insert upper handle into the lower handle by twisting together.

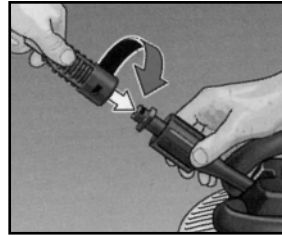

Step 4 Insert lower handle into main housing. Push down and turn clockwise 90° to lock in lower handle.



Step 5 Tighten lock collar to assemble by twisting counter clockwise.

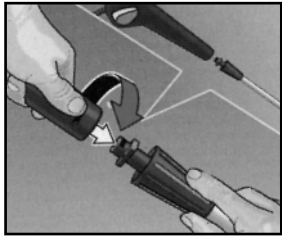

Step 6 Insert pressure washer wand into upper handle. Push wand down over upper handle and twist clock-wise 1/4 turn into locked position.

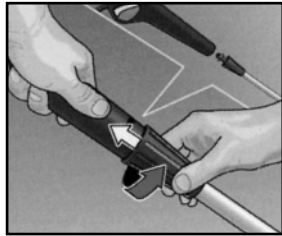

Step 7 Turn locking collar clock-wise over pressure washer wand until tight.

OPERATION CONTROLS

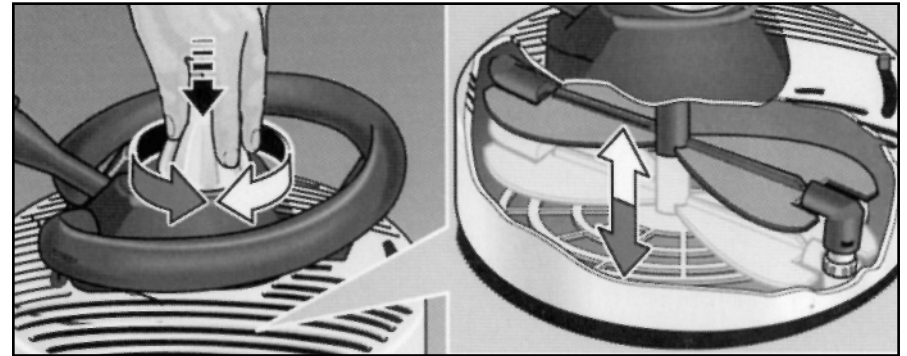

Spray Power Adjust height of propeller spray head. Clockwise for wood surfaces counter clockwise for stone, concrete and tile.

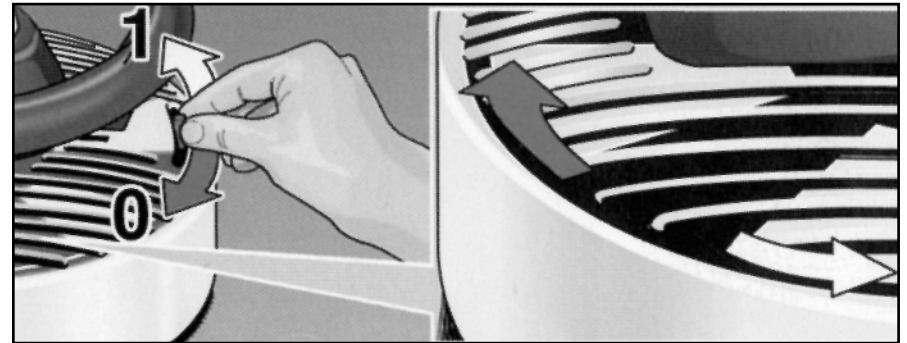

Air Flow Control Adjust the hover effect of the K12 Surface Cleaner by pushing the Air Flow Control into one of the positions from 0 – 1. The lowest position is 0 and the highest position is 1.



Please Note:

- For optimum setting test the spray power in an unseen area.
- Never operate in the same area for more than 2 seconds, damage may occur
- Do not use on windows..

NORMAL OPERATION SETTINGS



Horizontal Wood and Decks

Adjust height of the spray head clockwise. Open (0) the air flow vents.

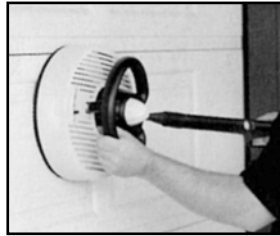
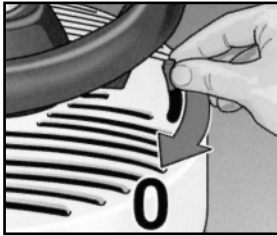

Vertical Wood, Siding and Facades

Adjust height of the spray head clockwise. Close (1) the air flow vents. **Do not use on windows.**

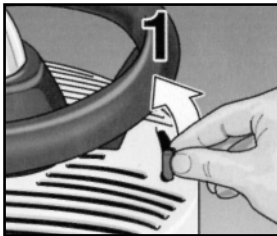
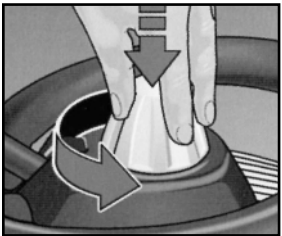

Horizontal Tile, Concrete and Stone

Adjust height of the spray head counter clockwise. Open (0) the air flow vents.

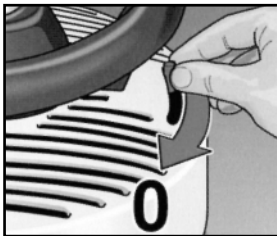

Vertical Tile, Concrete and Stone

Adjust height of the spray head Counter clockwise. Close (1) the air flow vents.

PARTS LIST

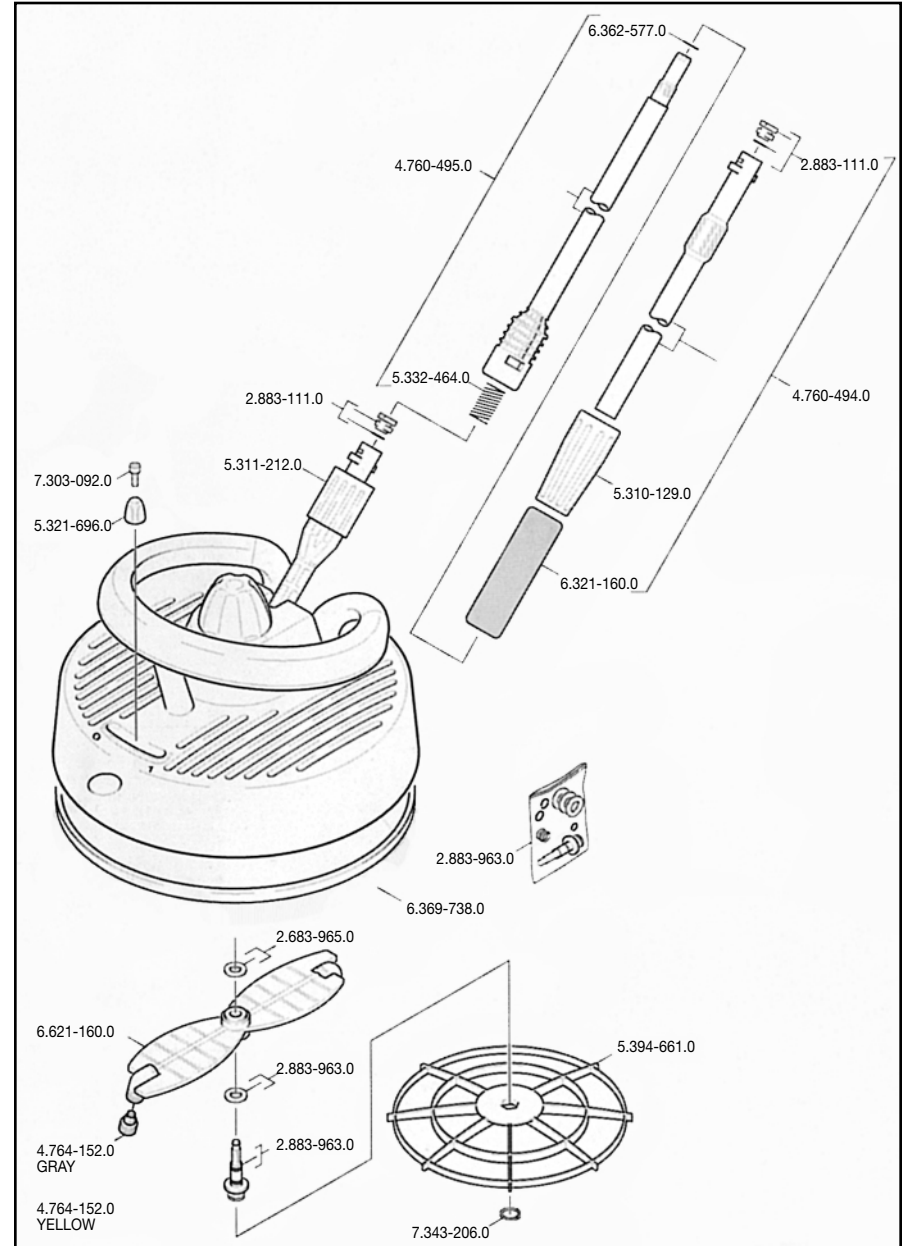

In USA Call:
1-800-537-4129
or visit our website: www.karcher-usa.com

