

Nozzle Cleaning Tool

A clogged spray nozzle may produce a poor spray pattern.

Nozzle Cleaning Instructions

⚠ WARNING

SHUT OFF WASHER AND PULL GUN TRIGGER TO RELIEVE FLUID PRESSURE BEFORE STARTING CLEANING PROCEDURE.

Remove wand from gun. Place nozzle cleaning tool in end of nozzle and push through hole to dislodge obstruction. Backflush water or blow air through nozzle to remove material. Repeat if required. Attach tool to pressure washer with locking tie for future use.

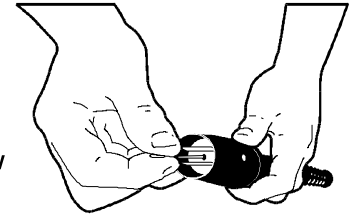

DeVilbiss Air Power Company

OWNERS MANUAL FOR PRESSURE WASHER Model No. WG1420

SPECIFICATION CHART

MODEL	WG1420
PUMP PRESSURE	1400 P.S.I. MAX
FLOW RATE	2.0 G.P.M.
HORSEPOWER	3.5 HP GAS ENGINE
HOSE	25' HIGH PRESSURE HOSE
PKG. WEIGHT	55 LBS.
INLET WATER PRESSURE	20-145 P.S.I.
INLET WATER TEMPERATURE	60°C/140°F Maximum

⚠ WARNING

Read Owner's Manual. Do not operate equipment until you have read Owners Manual for Safety, Operation, and Maintenance Instructions.

- **This product is not equipped with a spark arresting muffler.** If the product will be used around flammable materials, or on land covered with materials such as agricultural crops, forest, brush, grass, or other similar items, then an approved spark arrester must be installed and is legally required in the state of California. It is a violation of California statutes section 130050 and/or sections 4442 and 4443 of the California Public Resources Code, unless the engine is equipped with a spark arrester, as defined in section 4442, and maintained in effective working order. Spark arresters are also required on some U. S. Forest service land and may also be legally required under other statutes and ordinances.
- Engine exhaust from this product contains chemicals known, in certain quantities, to cause cancer, birth defects or other reproductive harm.

TABLE OF CONTENTS

	<i>PAGE</i>
WARRANTY STATEMENT	3
SAFETY GUIDELINES	4
IMPORTANT SAFETY INSTRUCTIONS	4-7
GLOSSARY	7
GENERAL PARTS IDENTIFICATION	8
OPERATING INSTRUCTIONS	9
MAINTENANCE & STORAGE	10
MAINTENANCE SCHEDULE FOR PUMP	10
MAINTENANCE SCHEDULE FOR GAS ENGINE	11
TROUBLE SHOOTING GUIDE	11
ACCESSORIES/CLEANING SOLUTIONS/ SERVICE PARTS	12-13
SERVICE NOTES.....	14-15

In the unlikely event you should have a problem with this product or if you are missing any parts, it is not necessary to return it to the store where you purchased it.

CALL TOLL-FREE 1-800-888-2468, EXT. 2

LIMITED WARRANTY

ONE YEAR FROM DATE OF PURCHASE

All merchandise manufactured by DeVilbiss Air Power Company is warranted to be free of defects in workmanship and material which occur during the first year from the date of purchase by the original purchaser (initial user). Products covered under this warranty include: air compressors, *air tools, accessories, service parts, pressure washers, and generators used in consumer applications (i.e., personal residential household usage only).

Air compressors, *air tools, accessories, service parts, pressure washers, and generators used in commercial applications (income producing) are covered by a 90 day warranty.

DeVilbiss Air Power will repair or replace, at DeVilbiss's option, products or components which have failed within the warranty period. Repair or replacement, and service calls on 60 and 80 gallon air compressors, will be handled by Authorized Warranty Service Centers and will be scheduled and serviced according to the normal work flow and business hours at the service center location, and depending on the availability of replacement parts.

All decisions of DeVilbiss Air Power Company with regard to this policy shall be final.

This warranty gives you specific legal rights, and you may also have other rights which vary from state to state.

RESPONSIBILITY OF ORIGINAL PURCHASER (Initial User):

- Retain original cash register sales receipt as proof of purchase for warranty work.
- Use reasonable care in the operation and maintenance of the product as described in the Owners Manual(s).
- Deliver or ship the product to the nearest DeVilbiss Air Power Authorized Warranty Service Center. Freight costs, if any, must be paid by the purchaser.
- Air compressors with 60 and 80 gallon tanks only will be inspected at the site of installation. Contact the nearest Authorized Warranty Service Center, that provides on-site service calls, for service call arrangement.
- If the purchaser does not receive satisfactory results from the Authorized Warranty Service Center, the purchaser should contact DeVilbiss Air Power Company.

THIS WARRANTY DOES NOT COVER:

- Merchandise sold as reconditioned, floor models and/or display models. Any damaged or incomplete equipment sold "as is".
- Merchandise used as "rental" equipment.
- Merchandise that has become inoperative because of ordinary wear, misuse, freeze damage, use of improper chemicals, negligence, accident, improper and/or unauthorized repair or alterations including failure to operate the product in accordance with the instructions provided in the Owners Manual (s) supplied with the product. *Air Tools: O-Rings and driver blades are considered ordinary wear parts, therefore, they are warranted for a period of 45 days from the date of purchase.
- An air compressor that pumps air more than 50% during a one hour period is considered misuse because the air compressor is undersized for the required air demand. Maximum compressor pumping time per hour is 30 minutes.
- Merchandise sold by DeVilbiss Air Power which has been manufactured by and identified as the product of another company. The product manufacturer's warranty will apply.
- Repair and transportation costs of merchandise determined not to be defective.
- Cost associated with assembly, required oil, adjustments or other installation and start-up cost.
- ANY INCIDENTAL, INDIRECT OR CONSEQUENTIAL LOSS, DAMAGE, OR EXPENSE THAT MAY RESULT FROM ANY DEFECT, FAILURE OR MALFUNCTION OF THE PRODUCT.** Some states do not allow the exclusion or limitation of incidental or consequential damages, so the above limitation or exclusion may not apply to you.
- IMPLIED WARRANTIES, INCLUDING THOSE OF MERCHANTABILITY AND FITNESS FOR A PARTICULAR PURPOSE, ARE LIMITED TO ONE YEAR FROM THE DATE OF ORIGINAL PURCHASE.** Some states do not allow limitations on how long an implied warranty lasts, so the above limitations may not apply to you.

DeVilbiss Air Power Company

213 Industrial Drive • Jackson, TN 38301-9615 • Telephone: 1-800-888-2468 , Ext. 2 • FAX: 1-800-888-9036

SAFETY GUIDELINES - DEFINITIONS

<p>This manual contains information that is important for you to know and understand. This information relates to protecting YOUR SAFETY and PREVENTING EQUIPMENT PROBLEMS. To help you recognize this information, we use the symbols to the right. Please read the manual and pay attention to these sections.</p>	<div style="border: 1px solid black; display: inline-block; padding: 2px 5px;">⚠ DANGER</div> <p>URGENT SAFETY INFORMATION - A HAZARD THAT WILL CAUSE SERIOUS INJURY OR LOSS</p>	<div style="border: 1px solid black; display: inline-block; padding: 2px 5px;">⚠ CAUTION</div> <p>Information that you should pay special</p>
	<div style="border: 1px solid black; display: inline-block; padding: 2px 5px;">⚠ WARNING</div> <p>IMPORTANT SAFETY INFORMATION - A HAZARD THAT MIGHT CAUSE SERIOUS INJURY OR LOSS</p>	<div style="border: 1px solid black; display: inline-block; padding: 2px 5px;">NOTE</div> <p>Information for preventing damage to equipment.</p>

IMPORTANT SAFETY INSTRUCTIONS

• **SAVE THESE INSTRUCTIONS** •

⚠ WARNING



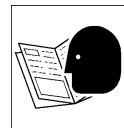

IMPROPER OPERATION OR MAINTENANCE OF THIS PRODUCT COULD RESULT IN SERIOUS INJURY AND PROPERTY DAMAGE. READ AND UNDERSTAND ALL WARNINGS AND OPERATING INSTRUCTIONS BEFORE USING



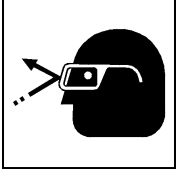
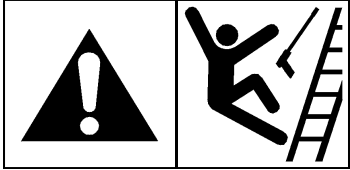

HAZARD	WHAT CAN HAPPEN	HOW TO PREVENT IT
<div style="text-align: center; margin-bottom: 5px;"> <div style="background-color: black; color: white; padding: 2px 5px; display: inline-block;">⚠ DANGER</div> </div> <p>RISK OF EXPLOSION OR FIRE</p> <div style="display: flex; justify-content: space-around; align-items: center;"> </div>	<ul style="list-style-type: none"> Spilled gasoline and it's vapors can become ignited from cigarette sparks, electrical arcing, exhaust gases, and hot engine components such as the muffler. Heat will expand fuel in the tank which could result in spillage. Operating the pressure washer in an explosive environment could result in a fire. Materials placed against or near the pressure washer can interfere with its proper ventilation features causing overheating and possible ignition of the materials. Improperly stored fuel could lead to accidental ignition. Fuel improperly secured could get into the hands of children or other unqualified persons. 	<ul style="list-style-type: none"> Shut off engine and allow it to cool before adding fuel to the tank. Use care in filling tank to avoid spilling fuel. Move pressure washer away from fueling area before starting engine. Keep maximum fuel level ½" below top of tank to allow for expansion. Operate and fuel equipment in well ventilated areas free from obstructions. Equip areas with fire extinguishers suitable for gasoline fires. Never operate pressure washer in an area containing dry brush or weeds. Store fuel in container approved for gasoline, in a secure location away from work area.
<div style="text-align: center; margin-bottom: 5px;"> <div style="background-color: black; color: white; padding: 2px 5px; display: inline-block;">⚠ DANGER</div> </div> <p>RISK TO BREATHING</p> <div style="text-align: center;"> </div>	<ul style="list-style-type: none"> Breathing exhaust fumes will cause serious injury or death. Some cleaning fluids contain substances which could cause 	<ul style="list-style-type: none"> Operate pressure washer in a well ventilated area. Avoid enclosed areas such as garages, basements, etc. Never operate unit in a location occupied by humans or animals. Use only cleaning fluids specifically recommended for high pressure washers. Follow manufacturers

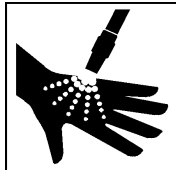
IMPORTANT SAFETY INSTRUCTIONS (cont'd)

HAZARD	WHAT CAN HAPPEN	HOW TO PREVENT IT
<p style="text-align: center;">⚠ WARNING RISK OF INJURY FROM SPRAY</p> 	<ul style="list-style-type: none"> • High velocity fluid spray can cause objects to break, propelling particles at high speed. • Light or unsecured objects can become hazardous projectiles. 	<ul style="list-style-type: none"> • Always wear ANSI approved Z87 safety glasses. Wear protective clothing to protect against accidental spraying. • Never point wand at, or spray people or animals. • Always secure trigger lock when wand is not in service to prevent accidental operation. • Never permanently secure trigger in pull back (open) position.
<p style="text-align: center;">⚠ WARNING RISK OF UNSAFE OPERATION</p> 	<ul style="list-style-type: none"> • Unsafe operation of your pressure washer could lead to serious injury or death to you or others. • The spray gun/wand is a powerful cleaning tool that could look like a toy to a child. • Reactive force of spray will cause gun/wand to move, and could cause the operator to slip or fall, or misdirect the spray. Improper control of gun/wand can result in injuries to self and others. 	<ul style="list-style-type: none"> • Become familiar with the operation and controls of the pressure washer. • Keep children away from the pressure washer at all times. • Never defeat the safety features of this product. • Do not operate machine with missing, broken, or unauthorized parts. • Never leave wand unattended while unit is running. • Keep work area free of obstacles. • Stand on a stable surface and grip gun/wand firmly. Expect the gun to kick when triggered.
<p style="text-align: center;">⚠ WARNING RISK OF ELECTRICAL SHOCK</p> 	<ul style="list-style-type: none"> • Spray directed at electrical outlets or switches, or objects connected to an electrical circuit, could result in a fatal electrical shock. 	<ul style="list-style-type: none"> • Unplug any electrically operated product before attempting to clean it. Direct spray away from electric outlets and switches.
<p style="text-align: center;">⚠ WARNING RISK TO FLUID INJECTION</p> 	<ul style="list-style-type: none"> • Your washer operates at fluid pressures and velocities high enough to penetrate human and animal flesh, which could result in amputation or other serious injury. Leaks caused by loose fittings or worn or damaged hoses can result in injection injuries. DO NOT TREAT FLUID INJECTION AS A SIMPLE CUT! See a physician immediately! • Relieve system pressure before attempting maintenance or disassembly of equipment. 	<ul style="list-style-type: none"> • Never place hands in front of nozzle. • Direct spray away from self and others. • Make sure hose and fittings are tightened and in good condition. Never hold onto the hose or fittings during operation. • Do not allow hose to contact muffler. • Never attach or remove wand or hose fittings while system is pressurized. • Use only hose and high pressure accessories rated for 3200 PSI service. • To relieve system pressure, shut off engine, turn off water supply, and pull gun trigger until water stops.

IMPORTANT SAFETY INSTRUCTIONS (cont'd)

HAZARD	WHAT CAN HAPPEN	HOW TO PREVENT IT
<p style="text-align: center;">⚠ WARNING</p> <p style="text-align: center;">RISK OF CHEMICAL BURN (CONT'D)</p> <div style="text-align: center;">  </div>	<ul style="list-style-type: none"> Use of acids, toxic or corrosive chemicals, poisons, insecticides, or any kind of flammable solvent with this product could result in serious injury or death. 	<ul style="list-style-type: none"> Do not use acids, gasoline, kerosene, or any other flammable materials in this product. Use only household detergents, cleaners and degreasers recommended for use in pressure washers. Wear protective clothing to protect eyes and skin from contact with sprayed materials.
<p style="text-align: center;">⚠ WARNING</p> <p style="text-align: center;">RISK OF HOT SURFACES</p> <div style="text-align: center;">  </div>	<ul style="list-style-type: none"> Contact with hot surfaces, such as engines exhaust components, could result in serious burn. 	<ul style="list-style-type: none"> During operation, touch only the control surfaces of the pressure washer. Keep children away from the pressure washer at all times. They may not be able to recognize the hazards of this product.

GPW00496

GLOSSARY

PSI: Unit of measure, pounds per square inch.

FLOW RATE: This is the amount of water that passes through your wand. (Usually measured in G.P.M., gallons per minute).

PUMP PRESSURE: Can be adjusted from 100-1400 P.S.I. by turning pressure regulator.

PRESSURE WASHER PUMP: Delivers high water pressure. Pressure washer pump is shipped **with** oil. No oil should be added to this pump.

3.5 HP Engine: Gasoline powered engine drives pump. Engine is shipped **with** oil. See Manufacturers Owner's Manual for oil recommendations.

⚠ CAUTION

Operating unit with water supply shut-off without flow of water will result in equipment damage.

BYPASS MODE: This pertains to the time that the pressure washer is running without the trigger on the gun engaged to spray. You should never run this pressure washer for more than 2 minutes without pulling the trigger to relieve pressure. Running the pressure washer in this manner would void your warranty.

GENERAL PARTS IDENTIFICATION

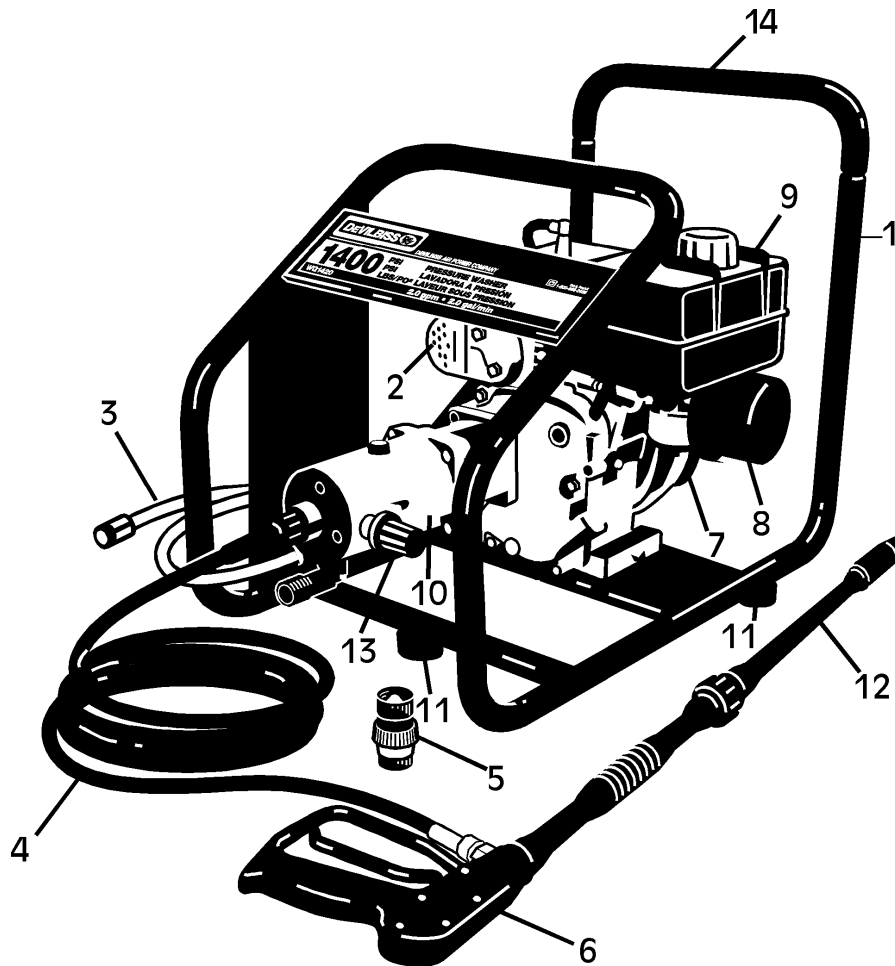

1. **Frame assembly**- Protects pump and engine as well as a means to handle complete unit.
2. **Exhaust Muffler**- Allows hot exhaust to exit the engine.
3. **Siphon Tube & Filter**- Used to pick up detergents, degreasers, etc. for cleaning.
4. **High Pressure Hose**- 25' x 1/4" dia. high pressure hose used to transport water from pump to gun.
5. **Quick Connect Coupler**- Used to attach water hose to pump.
6. **Pressure Washer Gun**- Used to control flow of water coming from pump.
7. **3.5 HP Tecumseh Engine**- This engine is shipped **without** oil. Included with this pressure washer is a copy of the Engine Manufacturer's Operators' Manual. See this manual for more detail on the engine.
8. **Air Filter**- Contains air filter element. Refer to the Engine Operators' Manual for maintenance.
9. **Gas Tank**- Refer to the Engine Operators' Manual for suggested fuel.
10. **Pressure Washer Pump**- Delivers 1400 PSI at 2.0 gpm for optimal cleaning. Pump is shipped **with** oil. No oil should be added to this pump.
11. **Vibration Isolator**- Isolators reduce frame vibration and eliminates walking.
12. **Wand & Nozzle**- Metal thru construction with brass thread connection and durable stainless steel nozzle for added durability.
13. **Pressure Regulator**- used to adjust pressure of water coming from pump. Can be adjusted from 100-1400 PSI.
14. **Handle Assembly Instruction**- Remove nuts and bolts from parts bag. Install handle into position. Push bolts through holes provided. Install hex nuts to bolts and tighten.

OPERATING INSTRUCTIONS

⚠ WARNING

READ AND UNDERSTAND ALL WARNINGS AND INSTRUCTIONS IN THIS MANUAL BEFORE OPERATING.

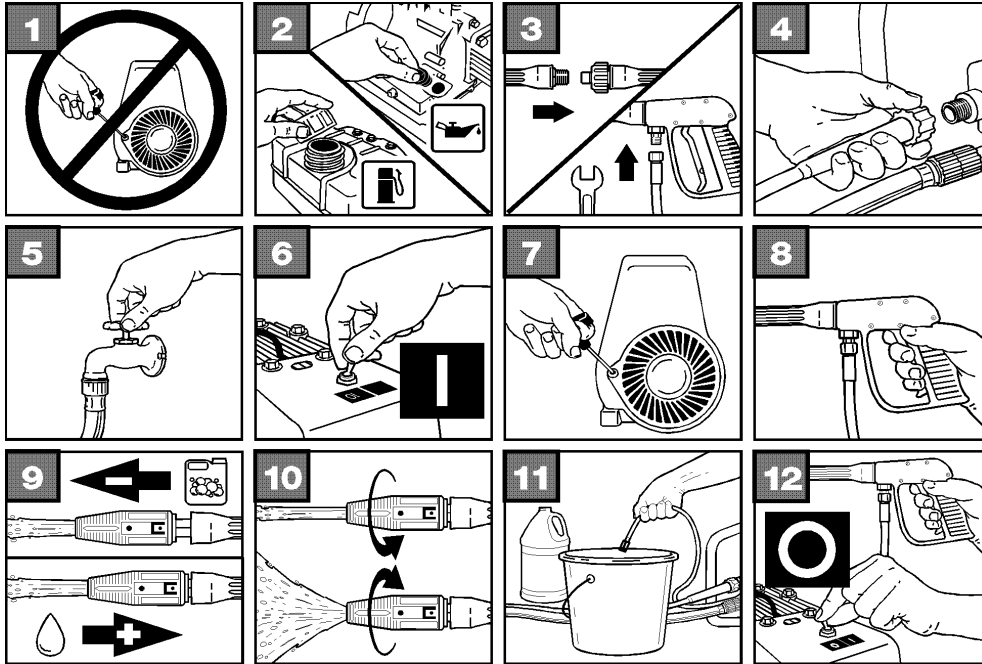

1. Do not start engine until you have read all warnings and instructions.
2. Fill oil sump or check oil level. Add "unleaded" regular gasoline, slowly, to fuel tank. Use a funnel to help avoid spillage. Never fill tank completely, fill tank to 1/2" below bottom of filler neck to allow for fuel expansion.
3. Connect wand to gun and hand tighten. Connect high pressure hose to gun body and tighten with wrench. Apply teflon tape if fittings leak.
4. Connect garden hose to washer using quick connect supplied with unit. Hand tighten. Connect high pressure hose to washer and hand tighten. Turn pressure regulator knob counter/clockwise to reduce starting load.
5. Turn on water. Pull trigger on gun until there is a steady stream of water to remove air that might be trapped in hoses and pump. **Operating unit with water supply shut-off without flow of water will result in equipment damage.**
6. Set toggle switch on engine to **RUN** position. Push primer 2 to 3 times. Wait about 2 seconds in between each push. In cold weather (50° F/10° C or below) push 5 times.
7. Grasp starter handle and pull rope out, slowly, until it pulls harder. Let rope rewind slowly. Then pull rope

with a rapid full arm stroke. Let rope return to starter slowly.

⚠ WARNING

DO NOT POINT WAND AT SELF OR OTHERS.

8. Pull trigger on gun to start pressure exiting from end of wand. The pressure washer may need to be re-primed if it has not been used for awhile. To do this hold the wand trigger in and turn the pressure regulator knob low to high several times until the unit will maintain pressure at the highest setting. (See pg. 8 - no. 13)
9. Adjust Low-High pressure at nozzle. Push nozzle forward to siphon soaps and cleaners. Pull nozzle back for high pressure water spray. Adjust pressure regulator knob on pump to vary water pressure.
10. Adjust spray pattern from wide to narrow by rotating nozzle.
11. For liquid soaps and cleaners, place suction tube in your liquid container. Push the wand nozzle forward to siphon liquid.
12. **⚠ CAUTION** : When you are finished spraying, move toggle switch on engine to "OFF" or "STOP" position to turn engine "OFF". Pull wand trigger to release pressure. Do not allow washer to run more than 5 minutes without pulling trigger.

MAINTENANCE AND STORAGE

⚠ CAUTION

This pressure washer should be stored in such a way to protect it from freezing. ***Do not** store this unit outdoors or in an area where temperatures will fall below 32°F. This can cause extensive damage to this unit. Drain as much water as possible as follows:

1. Put engine switch in "OFF" position and remove spark plug wire from spark plug.
2. Pull the trigger on the spray gun to release the pressure in the high pressure hose. Detach high pressure hose and garden hose from the unit.
3. Pull the starter handle on engine 4 to 6 times to discharge remaining water in pump.

⚠ CAUTION

*If unit has to be stored under freezing conditions a non-toxic R.V. anti-freeze can be used to protect from freezing.

Add anti-freeze as follows:

1. Put engine switch in "OFF" position and remove spark plug wire from spark plug.
2. Pull the trigger on the spray gun to release the pressure in the high pressure hose. Detach high pressure hose and garden hose from the unit.
3. Tip the unit on the end with the water inlet fitting pointing upward.
4. Pour approximately 1/4 cup of non-toxic R.V. anti-freeze down the plastic fitting where the water hose attaches to the pump.
5. Set unit upright and pull starter handle on engine 4 to 6 times to circulate anti-freeze in pump until anti-freeze is discharged from pump.

MAINTENANCE SCHEDULE FOR PUMP

⚠ WARNING

ALWAYS REMOVE SPARK PLUG WIRE FROM SPARK PLUG BEFORE ANY MAINTENANCE IS STARTED.

MAINTENANCE

1. **WATER SCREEN:**

Inspect the water screen before attaching water supply. Clean water screen if dirty. (The water screen is located in the quick connect coupler.)

2. **SIPHON HOSE:**

If the siphon tube is used for detergent or wax remove and place in a container of clean water. Run clean water through the unit to flush any detergent or wax from the pressure washer.

3. **NOZZLE CLOGGED:**

A clogged nozzle will cause the operating pressure to be too high causing the pressure washer to surge. If this happens:

1. Put engine switch in "OFF" position and remove wire from spark plug.
2. Pull trigger on gun handle to relieve pressure, remove wand assembly from gun assembly.
3. Clear the nozzle with the nozzle cleaning tip.

4. Flush wand assembly backwards with water or compressed air.
5. If pressure is still too high, repeat steps 2-4.

4. **CHECKING OIL:**

The pump is shipped with the correct amount of oil in it. This pump **should never** need any oil added or changed unless it develops a leak. A 30 weight non-detergent oil can be used in this pump (approximately 6 oz.).

If pump is leaking oil take to an Authorized Service Center.

⚠ WARNING

HIGH PRESSURE HOSE: Damaged high pressure hoses can burst which can cause a potentially hazardous situation. High pressure hoses should not be kinked, crushed, twisted, or damaged in any way. Replace high pressure hose should this occur.

MAINTENANCE SCHEDULE FOR GAS ENGINE

MAINTENANCE OPERATION	EVERY 5 HOURS OR DAILY	25 HOURS OR EVERY SEASON	50 HOURS OR EVERY SEASON	100 HOURS OR EVERY SEASON
Check Oil Level	X			
Change Oil *		X NOTE 1		
Change Air Filter		X NOTE 2		
Replace or Clean Spark Plug				X
Clean exterior of pressure washer				X NOTE 3

***Change oil after first 2 hours then after every 25 hours.**

Note 1: Change oil every 25 hours when operating under heavy load or in high temperatures.

Note 2: Clean more often under dusty conditions.

Note 3: Clean exterior with cloth or brush. Do not use high pressure spray to clean pressure washer or engine.

TROUBLESHOOTING GUIDE

PROBLEM	CAUSE	REMEDY
Engine will not start or stops while operating.	<ul style="list-style-type: none"> Low on fuel. Ignition switch in "Off" position. Faulty spark plug. Cold engine/engine not primed. Unit loaded during start-up. <ul style="list-style-type: none"> Spark plug wire loose. Fuel tank not venting properly 	<ul style="list-style-type: none"> Fill with gasoline. Turn to "ON" position. Replace spark plug. Push primer 2 to 3 times. Reduce pressure at pressure regulator knob. Attach wire to spark plug. Replace fuel tank cap.
Engine is running but pump is not building maximum pressure or has irregular pressure.	<ul style="list-style-type: none"> Water faucet closed. Unit has been allowed to freeze. Garden hose kinked. Water inlet screen clogged with debris. Pressure regulator on pump not set correctly. Unsuitable or worn out nozzle. Air trapped in pump. 	<ul style="list-style-type: none"> Open water faucet. Thaw out unit completely. Straighten hose. Clean water inlet screen. <ul style="list-style-type: none"> Adjust pressure regulator clockwise for more pressure. Replace nozzle. Run unit with gun open and wand removed.
Engine is overloaded.	<ul style="list-style-type: none"> Nozzle partially blocked. 	<ul style="list-style-type: none"> Clean nozzle.
Water leaking from head.	<ul style="list-style-type: none"> Head O-Ring worn. 	<ul style="list-style-type: none"> Take to Authorized Service Center.
Water leaking from bottom of pump. Oil leaking from bottom of pump.	<ul style="list-style-type: none"> Piston seals worn. Piston seals worn. 	<ul style="list-style-type: none"> Take to Authorized Service Center.
Noisy Pump.	<ul style="list-style-type: none"> Pump sucking air. 	<ul style="list-style-type: none"> Take to Authorized Service Center.
No low pressure detergent delivery.	<ul style="list-style-type: none"> Nozzle set in wrong position. Siphon hose or filter plugged. Siphon check valve clogged in pump. 	<ul style="list-style-type: none"> Push nozzle forward. Unplug siphon hose. Take to Authorized Service Center.

ACCESSORIES/CLEANING SOLUTIONS/SERVICE PARTS

HIGH PRESSURE ROTARY NOZZLE PART NUMBER WA100

- Fits DeVilbiss pressure washer gun
- High pressure rotating spray for maximum cleaning
- Durable ceramic nozzle
- Brass thread connections eliminate leakage

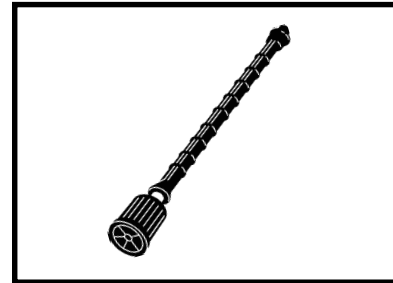

ANGLE ROTARY BRUSH KIT PART NUMBER WA200

- Fits DeVilbiss pressure washer wands
- 7 in. dia. nylon brush with rotating brush
- Adjustable- for angled surfaces
- 2 ft. extension for added reach
- Low pressure adapter included

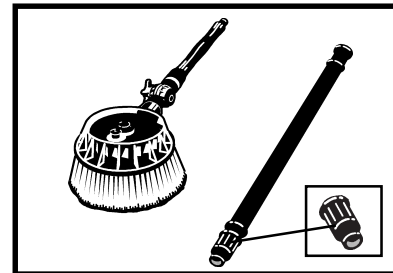

FIXED BRUSH KIT PART NUMBER WA250

- Fits DeVilbiss pressure washer wands
- 7 in. x 3 in. soft nylon bristles
- Tapered for cleaning in tight spots
- 2 ft. extension for added reach
- Low pressure adapter included

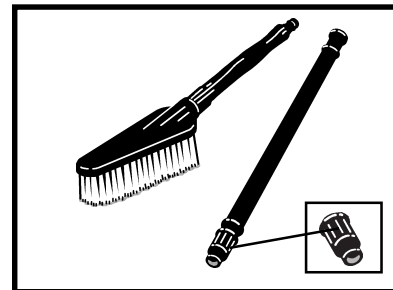

HIGH PRESSURE HOSE (50' length, 5/16" I.D.) PART NUMBER WA300

- Fits DeVilbiss pressure washers
- Replacement for 25 ft. hose
- 50 ft. x 5/16 in. high pressure hose
- Swivel fittings for easy connection



ACCESSORIES/CLEANING SOLUTIONS/SERVICE PARTS

HEAVY DUTY DEGREASER (1 gallon pre-mixed) PART NUMBER WA401

- For use with DeVilbiss pressure washers
- Cuts through grease and oil
- Removes grease, oil, and other tough stains
- Ideal for cleaning engines, grills, and farm equipment
- Pre-mixed – ready to use
- One U.S. gallon (3.79L)



GENERAL PURPOSE CLEANER (1 gallon pre-mixed) PART NUMBER WA400

- For use with DeVilbiss pressure washers
- Removes dirt and mildew without abrasives
- Ideal for cleaning house exteriors, automobiles, and more
- Pre-mixed – ready to use
- Biodegradable
- One U.S. gallon (3.79L)

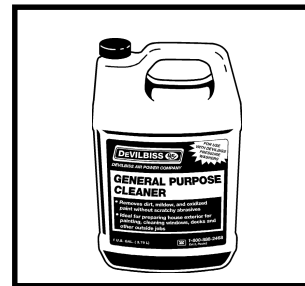

HANDLE/WHEEL KIT PART NUMBER K-0155

- Includes wheels and handle for portability
- Includes brackets for convenient storage of gun, wand, and hose

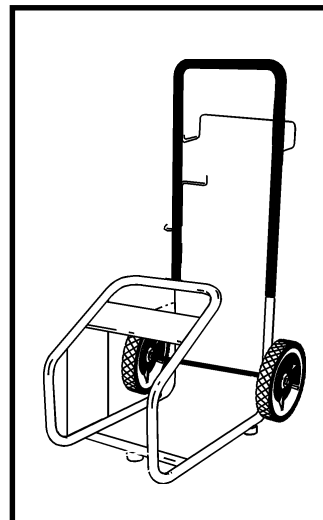

SERVICE PARTS

PW-0021	Quick Disconnect Coupler
PW-0024	Pressure Washer Gun
PW-0025	Wand/Nozzle, 1.25 mm
PW-0038	25' x 1/4" High Pressure Hose
PW-0042	Siphon Tube & Filter
PW-0044	Spark Arrester
PW-0045	Air Filter

SERVICE NOTES

OWNERS MANUAL FOR

DeVILBISS

PRESSURE WASHER

Model No.

WG1420

Attach Sales Receipt Here.
Retain Original Sales Receipt
as Proof of Purchase for
Warranty Repair Work.

WARRANTY

This product is covered by the
DeVilbiss one year limited
warranty (SP-100-E). The
warranty can be found on page
3 or is available upon request.

Call our **Toll Free Number 1-800-888-2468, Ext 2**, to obtain the location
of the nearest Authorized Service Center for ordering repair parts and
for warranty repairs.

When ordering repair parts from your local Authorized Service Center,
always give the following information:

- Model number of your product
- Part number and description of the item you wish
to purchase