

DeVILBISS AIR POWER COMPANY

PRESSURE WASHER

OWNERS MANUAL

for

Model 3540CWHP



⚠ WARNING

Read Owner's Manual. Do not operate equipment until you have read Owners Manual for Safety, Assembly, Operation, Maintenance and Storage Instructions.

- **This product is not equipped with a spark arresting muffler.** If the product will be used around flammable materials, or on land covered with materials such as agricultural crops, forest, brush, grass, or other similar items, then an approved spark arrester must be installed and is legally required in the state of California. It is a violation of California statutes section 130050 and/or sections 4442 and 4443 of the California Public Resources Code, unless the engine is equipped with a spark arrester, as defined in section 4442, and maintained in effective working order. Spark arresters are also required on some U. S. Forest service land and may also be legally required under other statutes and ordinances.
- This product may contain chemicals known to the state of California to cause cancer, birth defects, or other reproductive harm. This warning is given in compliance with California Proposition 65, as detectable amounts of chemicals subject to proposition 65 may be contained in this product.

⚠ CAUTION

ENGINE OIL MUST BE ADDED TO THE ENGINE BEFORE USE.

TABLE OF CONTENTS

Table of Contents	2	Assembly	7
Owner's Responsibilities	2	Operation	9
Pressure Washer Return Policy	2	Maintenance	15
Warranty	3	Storage	16
Safety Rules	4	Troubleshooting	17
Unpacking	6	Repair Parts	18
Contents of Carton	6	Quick Facts	back page

OWNER'S RESPONSIBILITIES

Congratulations! You have purchased a high quality product from America's leading manufacturer of pressure washers. This pressure washer, when properly used and maintained, will provide trouble free service. Please read and follow these instructions for proper use and maintenance.

- Read and understand all safety warnings.
- **Read this Owner's Manual. Save these instructions. Owner's manual should remain with unit at all times.**
- Do not operate this unit until you have read this Owners Manual for Safety, Operation, and Maintenance Instructions.
- **Read the Engine Owner's Manual supplied with this unit.**
- Do not operate this unit until you have read the Engine Owners Manual for Safety, Operation, and Maintenance Instructions.
- Check for visible shipping damage. Shipping damage will cause problems in operation of this unit.
- If you experience any problems and need assistance, please call us at our toll free number **1-800-888-2468, Ext 2**. 8:00 a.m. to 8:00 p.m. E.S.T.
- If you need warranty repair or service part purchase, you can locate an Authorized Warranty Service Center nearest you by calling us at **1-800-888-2468, Ext 2**, 24 hours a day, 7 days a week.

NOTE: Photos and illustrations in this manual are for reference only and may not represent a specific model.

PRESSURE WASHER RETURN POLICY

- Within 15 days of your purchase, Sam's will gladly exchange your pressure washer or refund your money. Sales receipt is required.
- After 15 days manufacturer's warranty applies.
- Refer to this Owners Manual for manufacturer's warranty.
- If you need warranty repair or service part purchase, you can locate an Authorized Warranty Service Center nearest you by calling us at **1-800-888-2468, Ext 2**, 24 hours a day, 7 days a week.

SAFETY GUIDELINES - DEFINITIONS

This manual contains information that is important for you to know and understand. This information relates to protecting **YOUR SAFETY** and **PREVENTING EQUIPMENT PROBLEMS**. To help you recognize this information, we use the symbols below. Please read the manual and pay attention to these sections.

⚠ DANGER

DANGER indicates an imminently hazardous situation which, if not avoided, **will** result in **death or serious injury**.

⚠ CAUTION

CAUTION indicates a potentially hazardous situation which, if not avoided, **may** result in **minor or moderate injury**.

⚠ WARNING

WARNING indicates a potentially hazardous situation which, if not avoided, **could** result in **death or serious injury**.

⚠ CAUTION

CAUTION used without the safety alert symbol indicates a potentially hazardous situation which, if not avoided, **may** result in **property damage**.

10/2/97

WARRANTY

All merchandise manufactured by DeVilbiss Air Power Company Manufacturing is warranted to be free of defects in workmanship and material which occur during the first year from the date of purchase by the original purchaser (initial user). Products covered under this warranty include: air compressors, *air tools, accessories, service parts, pressure washers, and generators used in consumer applications (i.e., personal residential household usage only).

Air compressors, *air tools, accessories, service parts, pressure washers, and generators used in commercial applications (income producing) are covered by a 90 day warranty.

DeVilbiss Air Power Manufacturing will repair or replace, at DeVilbiss' option, products or components which have failed within the warranty period. Repair or replacement, and service calls on 60 and 80 gallon air compressors, will be handled by Authorized Warranty Service Centers and will be scheduled and serviced according to the normal work flow and business hours at the service center location, and depending on the availability of replacement parts.

All decisions of DeVilbiss Air Power Company Manufacturing with regard to this policy shall be final.

This warranty gives you specific legal rights, and you may also have other rights which vary from state to state.

RESPONSIBILITY OF ORIGINAL PURCHASER (Initial User):

- To process a warranty claim on this product, DO NOT return it to the retailer. The product must be evaluated by an Authorized Warranty Service Center. For the location of the nearest Authorized Warranty Service Center call 1-800-888-2468, Ext. 2, 24 hours a day, 7 days a week or visit our web site @ devap.com.
- Retain original cash register sales receipt as proof of purchase for warranty work.
- Use reasonable care in the operation and maintenance of the product as described in the Owners Manual(s).
- Deliver or ship the product to the nearest DeVilbiss Air Power Manufacturing Authorized Warranty Service Center. Freight costs, if any, must be paid by the purchaser.
- Air compressors with 60 and 80 gallon tanks only will be inspected at the site of installation. Contact the nearest Authorized Warranty Service Center, that provides on-site service calls, for service call arrangement.
- If the purchaser does not receive satisfactory results from the Authorized Warranty Service Center, the purchaser should contact DeVilbiss Air Power Company Manufacturing.

THIS WARRANTY DOES NOT COVER:

- Merchandise sold as reconditioned, floor models and/or display models. Any damaged or incomplete equipment sold "as is".
- Merchandise used as "rental" equipment.
- Merchandise that has become inoperative because of ordinary wear, misuse, freeze damage, use of improper chemicals, negligence, accident, improper and/or unauthorized repair or alterations including failure to operate the product in accordance with the instructions provided in the Owners Manual (s) supplied with the product.
*Air Tools: O-Rings and driver blades are considered ordinary wear parts, therefore, they are warranted for a period of 45 days from the date of purchase.
- An air compressor that pumps air more than 50% during a one hour period is considered misuse because the air compressor is undersized for the required air demand. Maximum compressor pumping time per hour is 30 minutes.
- Merchandise sold by DeVilbiss Air Power Manufacturing which has been manufactured by and identified as the product of another company. The product manufacturer's warranty will apply.
- Repair and transportation costs of merchandise determined not to be defective.
- Cost associated with assembly, required oil, adjustments or other installation and start-up cost.
- ANY INCIDENTAL, INDIRECT OR CONSEQUENTIAL LOSS, DAMAGE, OR EXPENSE THAT MAY RESULT FROM ANY DEFECT, FAILURE OR MALFUNCTION OF THE PRODUCT.** Some states do not allow the exclusion or limitation of incidental or consequential damages, so the above limitation or exclusion may not apply to you.
- IMPLIED WARRANTIES, INCLUDING THOSE OF MERCHANTABILITY AND FITNESS FOR A PARTICULAR PURPOSE, ARE LIMITED TO ONE YEAR FROM THE DATE OF ORIGINAL PURCHASE.** Some states do not allow limitations on how long an implied warranty lasts, so the above limitations may not apply to you.





213 Industrial Drive • Jackson, TN 38301-9615
Telephone: 1-800-888-2468, Ext. 2
FAX: 1-800-888-9036





IMPORTANT SAFETY INSTRUCTIONS

⚠ WARNING

IMPROPER OPERATION OR MAINTENANCE OF THIS PRODUCT COULD RESULT IN SERIOUS INJURY AND PROPERTY DAMAGE. READ AND UNDERSTAND ALL WARNINGS AND OPERATING INSTRUCTIONS BEFORE USING.

HAZARD	WHAT CAN HAPPEN	HOW TO PREVENT IT
<p>⚠ DANGER RISK OF EXPLOSION OR FIRE</p> 	<ul style="list-style-type: none"> Spilled gasoline and its vapors can become ignited from cigarette sparks, electrical arcing, exhaust gases, and hot engine components such as the muffler. Heat will expand fuel in the tank which could result in spillage and possible fire explosion. Operating the pressure washer in an explosive environment could result in a fire. Materials placed against or near the pressure washer can interfere with its proper ventilation features causing overheating and possible ignition of the materials. Muffler exhaust heat can damage painted surfaces, melt any material sensitive to heat (such as siding, plastic, rubber, or vinyl), and damage live plants. Improperly stored fuel could lead to accidental ignition. Fuel improperly secured could get into the hands of children or other unqualified persons. Use of acids, toxic or corrosive chemicals, poisons, insecticides, or any kind of flammable solvent with this product could result in serious injury or death. 	<ul style="list-style-type: none"> Shut off engine and allow it to cool before adding fuel to the tank. Use care in filling tank to avoid spilling fuel. Move pressure washer away from fueling area before starting engine. Keep maximum fuel level ½" below top of tank to allow for expansion. Operate and fuel equipment in well ventilated areas free from obstructions. Equip areas with fire extinguishers suitable for gasoline fires. Never operate pressure washer in an area containing dry brush or weeds. Always keep pressure washer a minimum of four feet away from surfaces (such as houses, automobiles, or live plants) that could be damaged from muffler exhaust heat. Store fuel in an OSHA approved container, in a secure location away from work area. Do not spray flammable liquids
<p>⚠ DANGER RISK TO BREATHING</p> 	<ul style="list-style-type: none"> Breathing exhaust fumes will cause serious injury or death. Some cleaning fluids contain substances which could cause injury to skin, eyes, or lungs. 	<ul style="list-style-type: none"> Operate pressure washer in a well ventilated area. Avoid enclosed areas such as garages, basements ,etc. Never operate unit in a location occupied by humans or animals. Use only cleaning fluids specifically recommended for high pressure washers. Follow manufacturers recommendations. Do not use chlorine bleach or any other corrosive compound
<p>⚠ WARNING RISK OF UNSAFE OPERATION</p> 	<ul style="list-style-type: none"> Unsafe operation of your pressure washer could lead to serious injury or death to you or others. If proper starting procedure is not followed, engine can kickback causing serious hand and arm injury. The spray gun/wand is a powerful cleaning tool that could look like a toy to a child. Reactive force of spray will cause gun/wand to move, and could cause the operator to slip or fall, or misdirect the spray. Improper control of gun/wand can result in injuries to self and others. 	<ul style="list-style-type: none"> Become familiar with the operation and controls of the pressure washer. Keep operating area clear of all persons, pets, and obstacles. Do not operate the product when fatigued or under the influence of alcohol or drugs. Stay alert at all times. Never defeat the safety features of this product. Do not operate machine with missing, broken, or unauthorized parts. Never leave wand unattended while unit is running. If engine does not start after two pulls, squeeze trigger of gun to relieve pump pressure. Pull starter cord slowly until resistance is felt. Then pull cord rapidly to avoid kickback and prevent hand or arm injury. Keep children away from the pressure washer at all times. Do not overreach or stand on an unstable support. Grip gun/wand firmly with both hands. Expect the gun to kick when triggered.

IMPORTANT SAFETY INSTRUCTIONS

HAZARD	WHAT CAN HAPPEN	HOW TO PREVENT IT
<p>⚠ WARNING</p> <p>RISK OF ELECTRICAL SHOCK</p> 	<ul style="list-style-type: none"> • Spray directed at electrical outlets or switches, or objects connected to an electrical circuit, could result in a fatal electrical shock. 	<ul style="list-style-type: none"> • Unplug any electrically operated product before attempting to clean it. Direct spray away from electric outlets and switches.
<p>⚠ WARNING</p> <p>RISK TO FLUID INJECTION</p> 	<ul style="list-style-type: none"> • Your washer operates at fluid pressures and velocities high enough to penetrate human and animal flesh, which could result in amputation or other serious injury. Leaks caused by loose fittings or worn or damaged hoses can result in injection injuries. DO NOT TREAT FLUID INJECTION AS A SIMPLE CUT! See a physician immediately! • Relieve system pressure before attempting maintenance or disassembly of equipment. 	<ul style="list-style-type: none"> • Never place hands in front of nozzle. • Direct spray away from self and others. • Make sure hose and fittings are tightened and in good condition. Never hold onto the hose or fittings during operation. • Do not allow hose to contact muffler. • Never attach or remove wand or hose fittings while system is pressurized. • Use only hose and high pressure accessories rated for pressure higher than your pressure washer's p.s.i. • To relieve system pressure, shut off engine, turn off water supply, and pull gun trigger until water stops flowing.
<p>⚠ WARNING</p> <p>RISK OF CHEMICAL BURN</p> 	<ul style="list-style-type: none"> • Use of acids, toxic or corrosive chemicals, poisons, insecticides, or any kind of flammable solvent with this product could result in serious injury or death. 	<ul style="list-style-type: none"> • Do not use acids, gasoline, kerosene, or any other flammable materials in this product. Use only household detergents, cleaners and degreasers recommended for use in pressure washers. • Wear protective clothing to protect eyes and skin from contact with sprayed materials.
<p>⚠ WARNING</p> <p>RISK OF HOT SURFACES</p> 	<ul style="list-style-type: none"> • Contact with hot surfaces, such as engines exhaust components, could result in serious burn. 	<ul style="list-style-type: none"> • During operation, touch only the control surfaces of the pressure washer. Keep children away from the pressure washer at all times. They may not be able to recognize the hazards of this product.
<p>⚠ DANGER</p> <p>RISK OF INJURY AND PROPERTY DAMAGE WHEN TRANSPORTING OR STORING</p> 	<ul style="list-style-type: none"> • Fuel or oil can leak or spill and could result in fire or breathing hazard, serious injury or death can result. Fuel or oil leaks will damage carpet, paint or other surfaces in vehicles or trailers. 	<ul style="list-style-type: none"> • If pressure washer is equipped with a fuel shut-off valve, turn the valve to the off position before transporting to avoid fuel leaks. If pressure washer is not equipped with a fuel shut-off valve, drain the fuel from tank before transporting. Only transport fuel in an OSHA approved container. Always place pressure washer on a protective mat when transporting to protect against damage to vehicle from leaks. Remove pressure washer from vehicle immediately upon arrival at your destination.

⚠ CAUTION

The powerful spray from your pressure washer is capable of causing damage to surfaces such as wood, glass, automobile paint, auto stripping and trim, and delicate objects such as flowers and shrubs. Before spraying, check the item to be cleaned to assure yourself that it is strong enough to resist damage from the force of the spray. Avoid the use of the concentrated spray stream except for very strong surfaces like concrete and steel.

Operating unit with water supply shutoff without flow of water will result in equipment damage. Operating the pressure washer with water supply shutoff will void your warranty. You should never run this pressure washer for more than 2 minutes without pulling the trigger to allow cool water to enter the pump and the heated (recirculated) water to exit.

CONTENTS OF CARTON

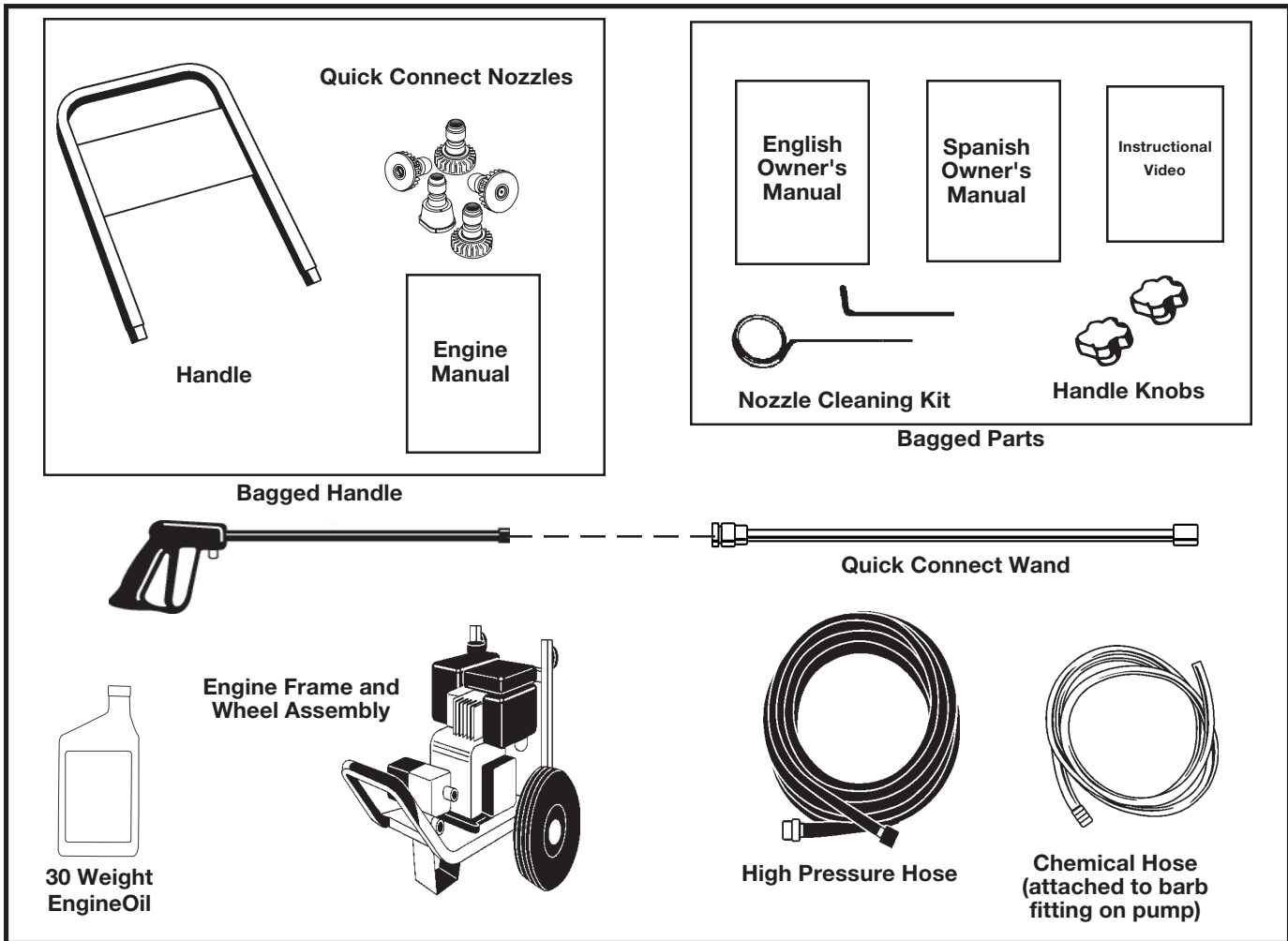

UNPACKING

1. Open carton.
2. Remove plastic bag containing handle, nozzles, and engine manual supplied by engine manufacturer.
3. Remove cardboard from top of unit and inner cardboard from around unit.
4. Remove plastic bag containing two knobs, nozzle cleaning kit, instructional video, English Owner's Manual, and Spanish Owner's Manual from carton.
5. Remove spray gun, quick connect wand, and bottle of engine oil from carton.
6. Using box cutting tool, cut the four corners of the shipping carton from top to bottom, then lay panels flat. **NOTE:** Be careful not to cut into chemical hose and high pressure hose.
7. Insert handle ends into pressure washer frame as shown.
8. Install two knobs as shown and tighten securely.
9. Grasp handle and roll unit off of carton.
10. Remove high pressure hose from carton and store in gun/hose holder as shown in **Pressure Washer Basics** section in this manual.

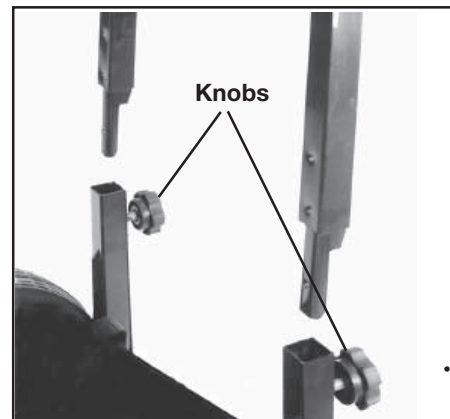

ASSEMBLY

1. Connect threaded end of quick connect wand to spray gun as shown. Tighten securely.



2. Place assembled spray gun, quick connect, wand, and chemical hose in gun/hose holder.
3. Add 30 weight engine oil (supplied) to engine. Refer to engine manual supplied by engine manufacturer for procedure. Do not overfill. Use of a funnel is recommended.

NOTE

There will be a slight amount of oil in the engine from factory testing.

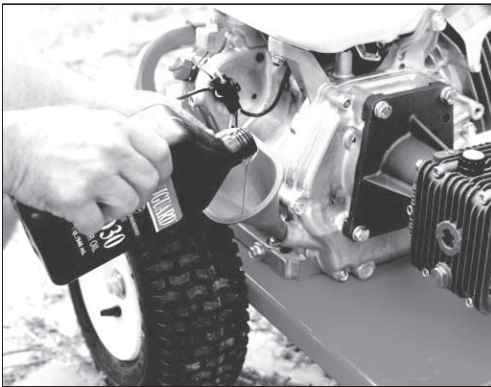

NOTE

The engine on this pressure washer is equipped with a low oil sensor. The amount of oil in the engine must be correct or the engine will not start.



WARNING

THE PUMP IS SHIPPED FROM THE FACTORY WITH OIL IN IT AND A RED SHIPPING PLUG TO PREVENT ANY OIL FROM LEAKING OUT OF THE PUMP DURING SHIPMENT. ATTACHED TO THE SHIPPING PLUG IS A PLASTIC BAG (SEE THE FOLLOWING PHOTO) WHICH CONTAINS THE DIPSTICK/OIL PLUG THE SHIPPING PLUG MUST BE REMOVED AND THE DIPSTICK/OIL PLUG INSTALLED BEFORE THE PRESSURE WASHER IS OPERATED.

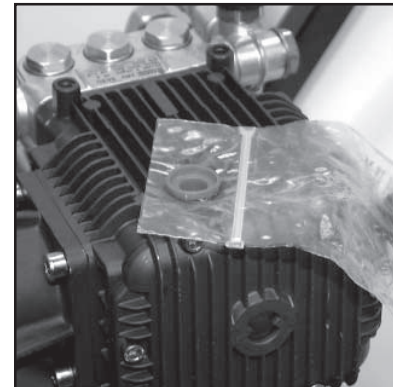

4. Using a 17 mm wrench, remove shipping plug from pump by turning it counterclockwise. Discard plug.
5. Remove dipstick/oil plug from plastic bag. Before installing dipstick/oil plug into pump, check the pump oil level. See **Pump** paragraph in **Maintenance** section of this manual.
6. Remove five colored quick connect nozzles from plastic bag and insert them into correct receptacle on panel **NOTE:** Nozzles are color coded to match colored squares on panel.



OPERATION

NOTE: Become familiar with the controls and features described on these pages before operating your unit.

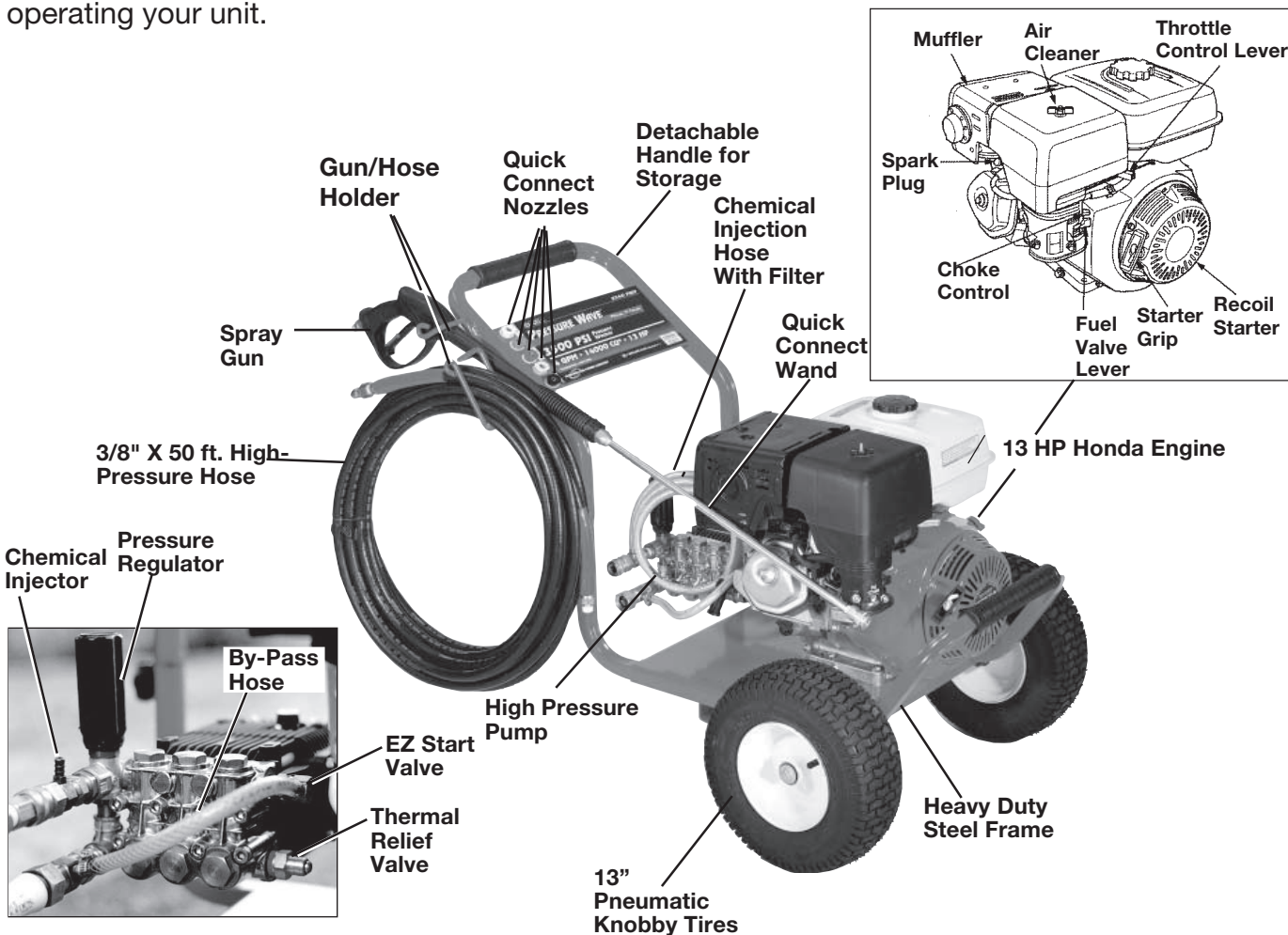

BASIC ELEMENTS OF A PRESSURE WASHER

High Pressure Pump: Increases the pressure of the water supply to 3500 psi @ 4 gpm.

13HP Honda Engine: Drives the high pressure pump.

High Pressure Hose: Carries the pressurized water from the pump to the gun and wand.

Spray Gun: Connects with wand to control water flow rate, direction, and pressure.

Quick Connect Wand: Used to aim the pressurized water spray.

Quick Connect Nozzles: Develops the spray pattern and restricts the water flow so water pressure can be maintained.

Chemical Hose: Allows cleaners or cleaning solvents to be mixed with the pressurized water stream. See **How To Siphon Chemicals/Cleaning Solvents in Operation** section of this manual.

Pressure Regulator/Unloader: Adjust output pressure of pump.

Thermal Relief Valve: A safety device that protects the pump from overheating. When water inside the pump reaches a specified temperature, the thermal relief valve opens and discharges the heated water from the pump.

EZ Start Valve: Allows the starter cord on the engine to be pulled without causing a pressure build up in the hose.

BASIC ELEMENTS OF ENGINE

Fuel Valve Lever: Opens and closes connection between fuel tank and carburetor.

Engine Switch: Enables and disables ignition system.

Choke Control Lever: Opens and closes the choke valve in carburetor.

Throttle Control Lever: Controls engine speed.

Starter Grip: Pulling starter grip operates recoil starter to crank engine.

OPERATION

PRESSURE WASHER TERMINOLOGY

PSI: Pounds per Square Inch. The unit of measure for water pressure. Also used for air pressure, hydraulic pressure, etc.

GPM: Gallons Per Minute. The unit of measure for the flow rate of water through the pressure washer.

CU: Cleaning Units. GPM multiplied by PSI.

Bypass Mode: In Bypass Mode, the pump is recirculating water because the trigger of the spray gun is not pulled.

Chemical Injection: Feeds cleaning agents into the pump to mix with the pressurized water and help in cleaning.

Water Supply: All pressure washers must have a source of water. The minimum requirements for a water supply are 20 PSI and 5 gallons per minute.

NOTE: Any supply pressure or delivery rate less than this will not allow the pressure washer to operate at its full potential.

OPERATING FEATURES OF YOUR PRESSURE WASHER

BYPASS MODE

During normal operation water supply is turned on, engine is running, spray gun trigger is depressed, and the cold water supply circulates inside the pressure washer pump allowing pump to maintain a safe operating temperature. When you release spray gun trigger and engine is still running, you are in bypass mode.

When unit is in bypass mode, water circulating inside the pump begins to heat up. If unit is left in bypass mode for more than two (2) minutes, the water temperature will rise to a dangerous level and damage internal components of the pump.

If pressure washer is operated without an adequate water supply or operated for more than two (2) minutes without depressing the spray gun trigger, the pump will overheat and be seriously damaged. Any damage to pump due to these causes **will not be covered under warranty.**

THERMAL RELIEF VALVE

In an effort to prevent damage, pumps are equipped with a **thermal relief valve**. This valve will open when the temperature inside the pump rises too high. This valve will then release a gush of water in an effort to lower the temperature inside the pump. Immediately after this occurs, the valve will close.

⚠ CAUTION

DO NOT allow your unit to operate in bypass mode for more than two minutes at any time. Overheating of pump will cause damage to pump.

PRESSURE ADJUSTMENT

⚠ CAUTION

DO NOT attempt to increase pump pressure. A higher pressure setting than the factory set pressure will damage pump.

The pressure output of the pump is preset at the factory to achieve optimum pressure and cleaning. If you need to lower the pressure, it can be accomplished by one of these three methods:

1. Back away from the surface being cleaned. The farther away you are, the less pressure is delivered to the surface being cleaned.
2. Adjust the pressure regulator knob on the pump.
 - a. Turn the pressure regulator knob counter-clockwise.
 - b. Once you have finished using your pressure washer, return the pressure regulator knob to its original position by turning it clockwise until it stops.

⚠ CAUTION

DO NOT try to turn pressure regulator knob past the built-in stop or damage to pump will result

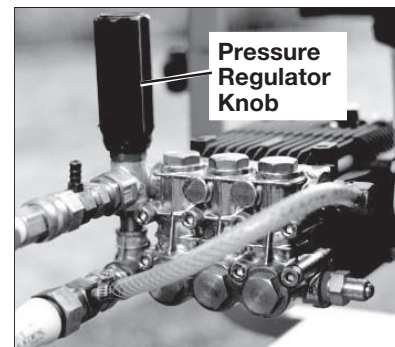

3. Reduce the speed of the gasoline engine (RPM). Slow engine down and water pressure will go down with it.

SPRAY NOZZLES

Your pressure washer is equipped with five spray nozzles. Each nozzle is color coded and delivers a specific spray pattern for a particular cleaning purpose. The size of the nozzle determines the size of the fan spray and the pressure out of the nozzle. The 0°, 15°, 25°, and 40° nozzles are high pressure nozzles. The chemical nozzle is a low pressure nozzle.

OPERATION

The nozzles are housed in receptacles on the panel of the pressure washer handle. Color squares on the panel identify nozzle location and spray pattern.



NOTE

A nozzle is easier to remove from its receptacle if it is pushed from underneath while it is being pulled from above.

⚠ WARNING

RISK OF INJECTION OR INJURY TO PERSON. DO NOT DIRECT DISCHARGE STREAM TOWARD PERSONS.

⚠ DANGER

WHEN USING THE HIGH PRESSURE NOZZLES, DO NOT ALLOW THE JET-LIKE SPRAY TO COME IN CONTACT WITH UNPROTECTED SKIN, EYES, OR WITH ANY PETS OR ANIMALS. SERIOUS INJURY CAN OCCUR.

0° nozzle - Red. This nozzle delivers a pinpoint stream and is extremely powerful. It covers a very small area of cleaning. This nozzle should only be used on surfaces that can withstand this high pressure such as metal or concrete. Do not use on wood.

15° nozzle - Yellow. This nozzle delivers a powerful 15 degree spray pattern for intense cleaning of small areas. This nozzle should only be used on areas that can withstand the high pressure from this nozzle.

25° nozzle - Green. This nozzle delivers a 25 degree spray pattern for intense cleaning of larger areas. This nozzle should only be used on areas that can withstand the pressure from this nozzle.

40° nozzle - White. This nozzle delivers a 40 degree spray pattern and a less powerful stream of water. It covers a wide area of cleaning. This nozzle should be used for most general cleaning jobs.

Chemical nozzle - Black. This nozzle is used to apply chemicals or cleaning solutions. It has the least powerful stream.

CHANGING NOZZLES

⚠ CAUTION

DO NOT attempt to change nozzles while pressure washer is running. Turn engine off before changing nozzles.

To change nozzles on the wand:

1. Pull quick connect coupler back and insert nozzle.
2. Release quick connect coupler and twist nozzle to make sure it is secure in coupler.

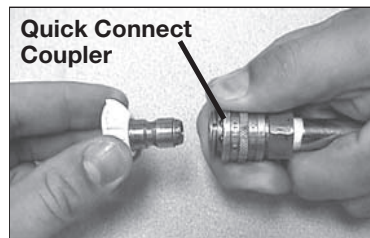

HOW TO SIPHON CHEMICALS/CLEANING SOLVENTS

Siphoning chemicals or cleaning solvents is a low pressure operation.

NOTE

Use only soaps and chemicals designed for pressure washer use. Do not use bleach.

To siphon chemicals:

1. Press chemical hose onto barbed fitting located near high pressure hose connection of pump as shown.

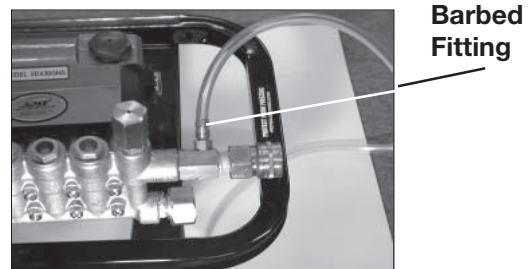

2. Place other end of chemical hose with filter on it into container holding chemical/cleaning solution.
3. Install low pressure (black) nozzle into quick connect fitting of wand as shown.

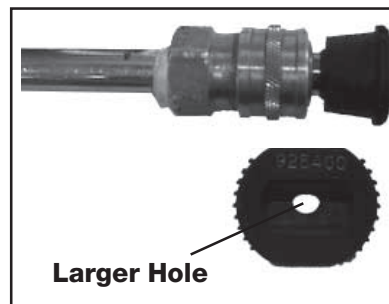

4. After use of chemical, siphon clean water through chemical hose to rinse it and pump clean. Chemicals which remain in pump can damage it. Damage to pump due to chemicals will not be covered under warranty.

NOTE

Chemicals and soap will not siphon when using high pressure nozzles.

OPERATION

BEFORE STARTING

1. Move pressure washer to level ground.
2. Check engine oil level. Refer to engine manufacturer's manual for procedure.

NOTE

The engine on this pressure washer is equipped with a low oil sensor. The amount of oil in the engine must be correct or the engine will not start.

3. Make sure shipping plug on pump has been replaced with dipstick/oil plug. See **Assembly** section in this manual.
4. Check oil level in pump. See **Pump** paragraph in the **Maintenance** section for correct procedure.
5. Select a nozzle for your cleaning job. See **Nozzles** in this section.
6. Install desired nozzle into quick connect coupler. See **Changing Nozzles** in this section.
7. Make sure screen filter is in water inlet of pump, as shown.

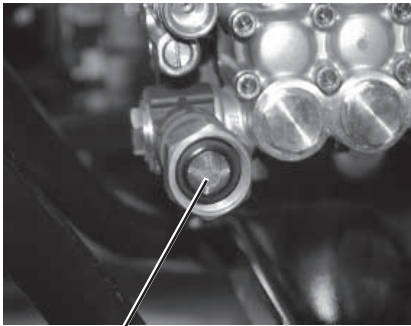

Screen Filter

8. Connect male end of water supply hose to water inlet of pump as shown.

NOTE

The water supply must provide a minimum of 5 gallons per minute at 20 PSI.

NOTE

Use cold water only.

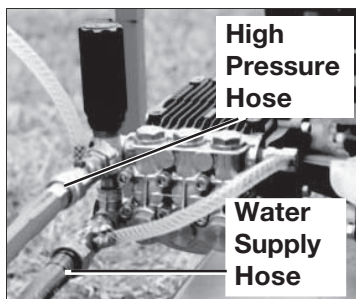

CAUTION

Never pull water supply hose to move unit. This could damage hose and/or pump inlet.

9. Attach one end of high pressure hose to spray gun as shown. This is a quick connect fitting and requires no tightening.



10. Attach other end of high pressure hose to quick connect fitting on pump as shown.



11. Make sure high pressure hose and water supply hose are securely connected to pump.
12. If you are applying a chemical or cleaning solution, See **How To Siphon Chemicals/Cleaning Solvents** in **Operation** section of this manual.
13. Turn water supply on.

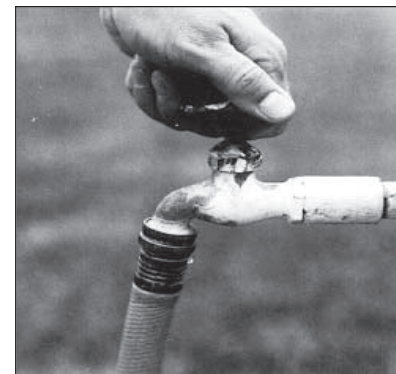

OPERATION

14. Add fresh, unleaded regular gasoline to engine fuel tank.

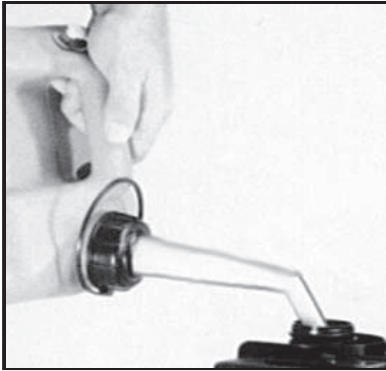

⚠ WARNING

NEVER FILL FUEL TANK INDOORS. NEVER FILL FUEL TANK WHEN ENGINE IS RUNNING OR HOT. DO NOT SMOKE WHEN FILLING FUEL TANK.

⚠ WARNING

NEVER FILL FUEL TANK COMPLETELY. FILL TANK TO 1/2" BELOW BOTTOM OF FILLER NECK TO PROVIDE SPACE FOR FUEL EXPANSION. WIPE ANY FUEL SPILLAGE FROM ENGINE AND EQUIPMENT BEFORE STARTING ENGINE.

⚠ WARNING

NEVER RUN ENGINE INDOORS OR IN ENCLOSED, POORLY VENTILATED AREAS. ENGINE EXHAUST CONTAINS CARBON MONOXIDE, AN ODORLESS AND DEADLY GAS.

TYPICAL HOOK-UP

Your pressure washer hook-up should resemble this diagram.

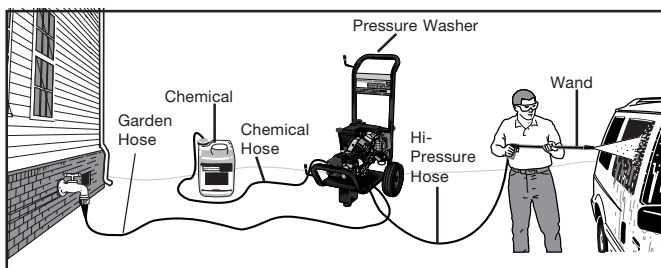

PRE-START CHECKLIST

Once you reach this point, ensure you have completed the following:

- ✓ All safety instructions read and understood?
- ✓ All hose connections are tightened and free of any kinks, damage, or leaks?
- ✓ Correct amount of engine oil and gasoline added to engine?
- ✓ Correct amount of oil in the pump?
- ✓ Nozzle installed in end of wand?
- ✓ Water supply (garden hose) turned on?
- ✓ All operation instructions read and understood?

If you can say "yes" to the items on the Pre-start checklist, you are ready to start your pressure washer.

STARTING YOUR PRESSURE WASHER

NOTE: Make sure water supply is turned on.

⚠ CAUTION

Never turn water supply off while pressure washer engine is running or damage to pump will result.

1. Move fuel valve lever to ON position.

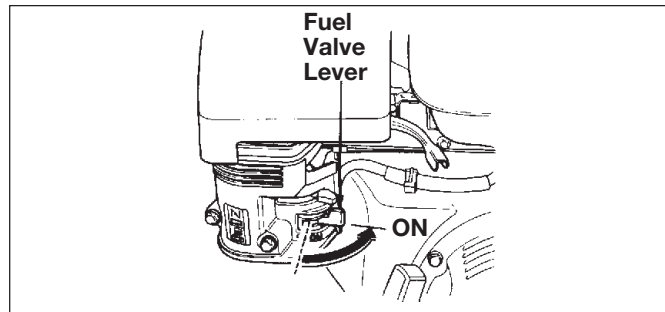

2. Move choke control lever to CLOSED position.

NOTE

To restart a warm engine, move choke control to ON position.

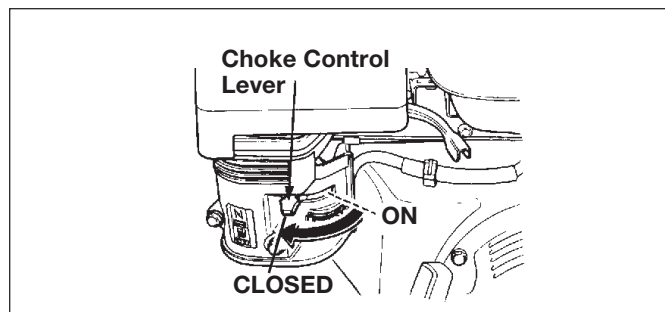

OPERATION

3. Move throttle control lever out of SLOW position, about 1/3 of the way toward FAST position.

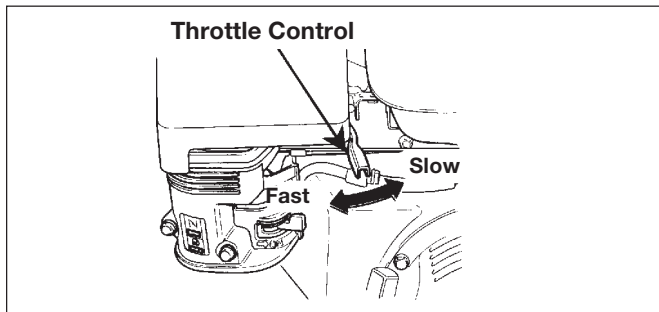

4. Turn engine switch to ON position.

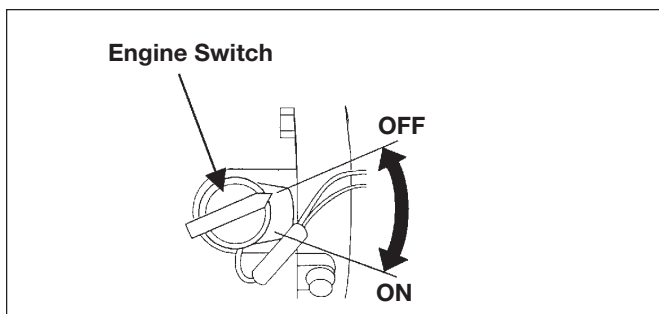

5. Pull starter grip slowly until you feel resistance, then pull briskly. Return starter grip gently.

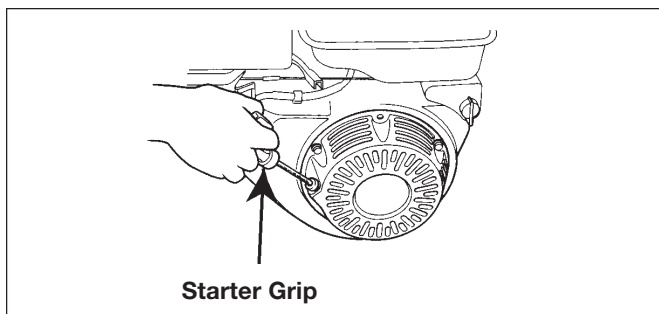

⚠ CAUTION

If engine does not start after two pulls, pull the trigger on spray gun to relieve pressure in hose. Failure to do so may cause damage to starter recoil mechanism of engine

⚠ WARNING

NEVER RUN ENGINE INDOORS OR IN ENCLOSED, POORLY VENTILATED AREAS. ENGINE EXHAUST CONTAINS CARBON MONOXIDE, AN ODORLESS AND DEADLY GAS.

6. If choke control lever is in CLOSED position, move lever to OPEN position as engine warms up.
7. Move throttle control to FAST position.

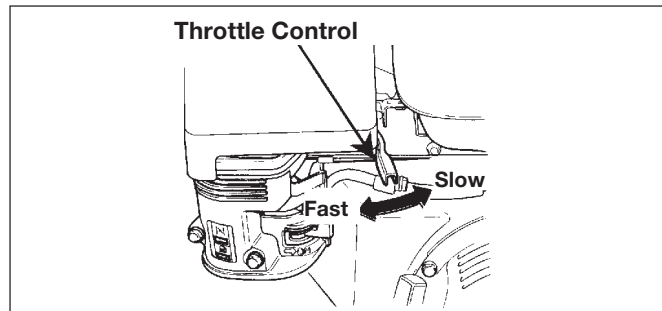

⚠ DANGER

WHEN USING THE HIGH PRESSURE SETTING, DO NOT ALLOW THE HIGH PRESSURE SPRAY TO COME IN CONTACT WITH UNPROTECTED SKIN, EYES, OR WITH ANY PETS OR ANIMALS. SERIOUS INJURY CAN OCCUR.

⚠ CAUTION

DO NOT stop spraying water for more than two minutes at a time. Pump operates in bypass mode when spray gun trigger is not pressed. If pump is left in bypass mode for more than two minutes internal components of the pump can be damaged.

⚠ CAUTION

DO NOT let hoses come in contact with very hot engine muffler during or immediately after use of your pressure washer. Damage to hoses from contact with hot engine surfaces will NOT be covered by warranty.

7. Depress trigger on gun to start water flow. Release trigger to stop water flow.

⚠ WARNING

STAND ON A STABLE SURFACE AND GRIP GUN/WAND FIRMLY WITH BOTH HANDS. EXPECT THE GUN TO KICK WHEN TRIGGERED.

9. Adjust nozzle spray for the task being performed. See **Spray Nozzle** instructions in the **Operation** section.

OPERATION

SHUTTING DOWN YOUR PRESSURE WASHER

1. If you have siphoned chemicals or cleaners, you must siphon clean water through chemical hose to flush chemical injector.
2. Continue to siphon clean water through hose and pump for at least one minute before turning off engine.

NOTE

Failure to siphon clean water through chemical hose and pump after siphoning chemicals or cleaners can cause damage to pump.

3. Move throttle control to STOP position to stop engine.

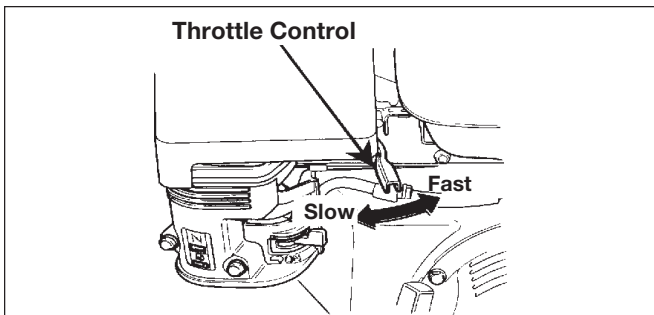

4. Turn engine switch to OFF position.

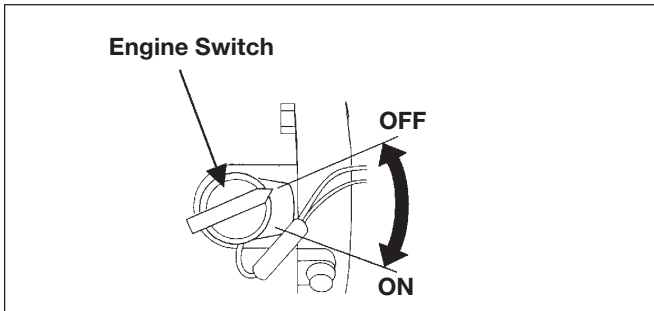

5. Move fuel valve lever to OFF position.

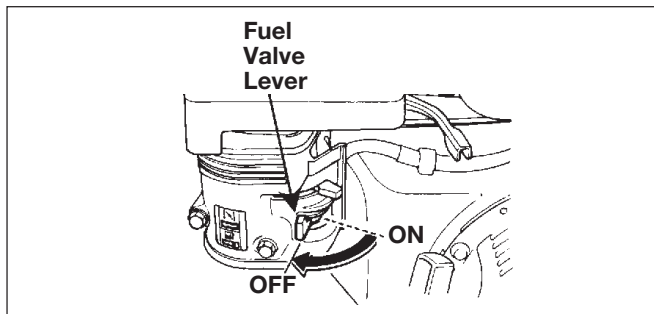

6. Turn off water supply.

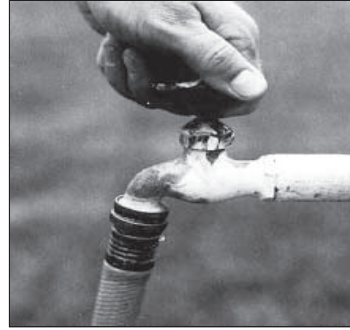

⚠ CAUTION

Never turn water supply off while pressure washer engine is running or damage to pump will result.

⚠ CAUTION

DO NOT let hoses come in contact with very hot engine muffler during or immediately after use of your pressure washer. Damage to hoses from contact with hot engine surfaces will NOT be covered by warranty.

7. Pull trigger on spray gun to relieve any water pressure in hose or spray gun.
8. Disconnect water supply hose from pump.
9. Coil high pressure hose and store in gun/hose holder.
10. Place spray gun in gun/hose holder.
11. Place chemical hose in gun/hose holder.

MAINTENANCE

⚠ DANGER

WHEN DOING MAINTENANCE, YOU MAY BE EXPOSED TO HOT SURFACES, WATER PRESSURE, MOVING PARTS, OR FIRE RESULTING IN DEATH. BEFORE PERFORMING ANY MAINTENANCE OR REPAIR, DISCONNECT SPARK PLUG WIRE, LET ENGINE COOL AND RELEASE ALL WATER PRESSURE. THE ENGINE CONTAINS FLAMMABLE FUEL. DO NOT SMOKE OR WORK NEAR OPEN FLAMES WHILE PERFORMING MAINTENANCE.

To ensure efficient operation and longer life of your pressure washer, a routine maintenance schedule should be prepared and followed. The following routine maintenance schedule is geared to an unit in a normal working environment. If necessary, the schedule should be modified to suit the conditions under which your pressure washer is used. The modifications will depend upon the hours of operation and the working environment. If the pressure washer is in an extremely dirty and/or hostile environment it will require a greater frequency of all maintenance checks.

ENGINE

1. Consult Engine Owner's Manual for manufacturer's recommendations for any and all engine maintenance.

PUMP

The Annovi Reverberi (AR) pump on your pressure washer was shipped from the factory with oil. The oil in your pump must be changed after the first 10 hours of use and every 50 hours thereafter.

To Check Oil:

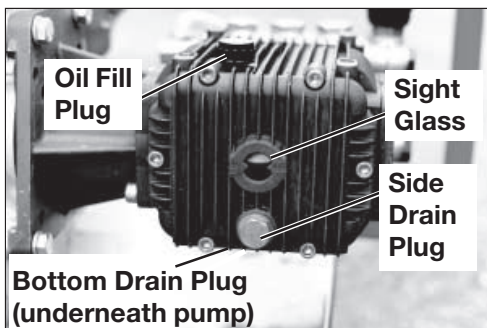

1. For units with sight glass:
 - a. If oil level is low, add oil so oil level is midway between high and low marks on sight glass.
 - b. If oil level is high, remove excess oil so oil level is midway between high and low marks on sight glass.
2. For units with dipstick:
 - a. Remove dipstick from pump and wipe clean.
 - b. Insert dipstick fully into pump, then remove it.
 - c. Oil level is correct when oil covers the lower 1/2 inch of end of dipstick.

To Change Oil:

1. Remove drain plug using one of the methods below:
 - a. If your AR pump has a side drain plug, use a 17 mm wrench to remove the plug and drain the pump.

- b. If your AR pump does not have a side drain plug, drain the pump by removing the bottom drain plug on the underside of the pump with an 8 mm Allen wrench.

2. Drain oil into a suitable container.
3. Replace oil drain plug and tighten securely.
4. Remove oil fill plug (or dipstick).
5. Add 18.5 oz of 30W non-detergent oil to pump.
6. Replace oil fill plug and tighten securely.

HOW TO CLEAN THE NOZZLES

If a spray nozzle becomes clogged with foreign material such as dirt, excessive pump pressure may develop and the spray pattern will change. If a nozzle becomes partially clogged or restricted, the pump pressure will pulsate. If this happens, clean the nozzle immediately using the nozzle cleaning kit supplied with your pressure washer. The procedure is as follows:

1. Shut off pressure washer and turn off water supply.
2. Pull trigger on spray gun to relieve any water pressure.
3. Disconnect quick connect wand from spray gun.
4. Remove nozzle from wand.
5. Inspect nozzle for obstructions, grime, or any foreign matter that could restrict flow of water.
6. Remove any obstructions with nozzle cleaning tools provided and back flush with clean water.
7. Direct water supply into nozzle end for 30 seconds to back flush loosened particles.
8. Take this opportunity to inspect wand for obstructions. Back flush wand if obstructions are seen.
9. Reassemble nozzle to wand.
10. Reconnect wand to spray gun and turn on water supply.
11. Start pressure washer and test spray pattern. See **Nozzles in Operation** section.
12. If spray pattern is still incorrect, replace nozzle.

MAINTENANCE

HOW TO CLEAN THE WATER INLET FILTER

This screen filter should be checked periodically and cleaned if necessary.

1. Remove filter by grasping end and removing it from water inlet of pump as shown.
2. Clean filter by flushing it with water on both sides.
3. Install filter into water inlet of pump.

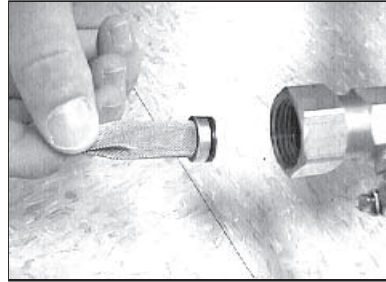

STORAGE

PREPARATION FOR STORAGE

It is recommended that you follow these steps to protect the internal seals of the pressure washer when **storing the unit for an extended period and WHEN FREEZING TEMPERATURES ARE EXPECTED.**

ENGINE

1. Remove gasoline from engine or add fuel stabilizer, such as "Sta-Bil" to gasoline to prevent gumming
2. If you are adding fuel stabilizer, connect water supply and high pressure hose to pump and spray gun.
3. Turn water supply on and start engine.
4. Squeeze spray gun trigger while engine is running to avoid operating pump in "bypass mode".
5. Run engine for five minutes, then shut engine off.
6. Disconnect water supply.
7. Disconnect spark plug wire and remove spark plug.
8. Pour one teaspoon of engine oil into spark plug hole.
9. Place a rag over the spark plug hole and pull starter rope slowly several times to lubricate internal cylinder wall.

PUMP

NOTE: If storing the unit for more than 30 days RV antifreeze needs to be ran through the pump. This helps prevent damage within the pump head. RV antifreeze is not only added for winterizing, but for proper lubrication regardless of temperature or environment. Storing the pump less than 30 days does not require the RV antifreeze.

1. Obtain a funnel, six ounces of RV antifreeze, and approximately 12 inches of garden hose with a male hose connector attached to one end.

⚠ CAUTION

Use only RV antifreeze. Any other anti-freeze is corrosive and can damage pump.

2. Disconnect high pressure hose from pump and from spray gun.
3. Connect 12 inch length of hose to water inlet of pump.
4. Add RV antifreeze to hose as shown.

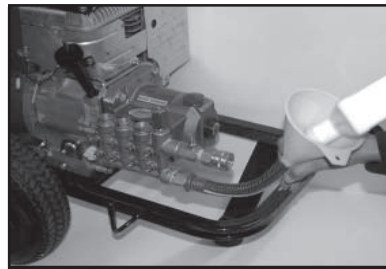

5. Pull engine starter rope slowly several times until antifreeze comes out of high pressure hose connection of pump.
6. Remove short hose from water inlet of pump.
7. Install spark plug into spark plug hole and tighten securely, then reconnect spark plug wire.
8. Drain all water from high pressure hose, coil it, and store it in cradle of pressure washer handle.
9. Drain all water from spray gun and wand by holding spray gun in a vertical position with nozzle end pointing down and squeezing trigger. Store in cradle on pressure washer handle.
10. Store nozzles in color matching receptacles on flat panel of pressure washer handle.
11. Store chemical hose, high pressure hose, spray gun, and wand so they are protected from damage, such as being run over.

TROUBLESHOOTING

PROBLEM	CAUSE	CORRECTION
Engine will not start (see Engine Manual for further engine troubleshooting)	<ol style="list-style-type: none"> 1. No fuel. 2. Low oil (if oil-alert equipped). 3. Pressure buildup after initial use. 4. Not primed or choked. 5. Spark plug wire not attached. 6. Engine ON/OFF switch in OFF position (If equipped.) 	<ol style="list-style-type: none"> 1. Add fuel. 2. Add required amount of oil. 3. Squeeze gun trigger to relieve pressure. 4. Push primer bulb 3 times or choke engine. 5. Attach spark plug wire. 6. Place engine ON/OFF switch to ON position.
No or low pressure (initial use)	<ol style="list-style-type: none"> 1. Wrong nozzle selected. 2. Low water supply. 3. Leak at high pressure hose. 4. Nozzle obstructed. 5. Water filter screen clogged. 6. Defective E-Z start valve. (If applicable) 7. Air trapped in hose. 	<ol style="list-style-type: none"> 1. Refer to page 11 for proper nozzle selection. 2. Water supply must be at least 5 GPM @ 20 PSI 3. Repair leak. Apply thread sealing tape if necessary. 4. Clean nozzle with nozzle cleaning tool, flush out obstruction with clean water. 5. Remove and clean filter. 6. Check with Authorized Warranty Service Center (AWSC.) 7. Turn off engine, then water supply. Disconnect water supply from pump inlet, then turn water supply on to remove all air from hose. When there is a steady stream of water present, turn water supply off. Reconnect water supply to pump inlet and turn on water supply. Squeeze trigger of spray gun to remove remaining air.
Will not draw chemicals	<ol style="list-style-type: none"> 1. Low pressure nozzle not in wand. 2. Chemical filter clogged. 3. Chemical hose not in chemical. 	<ol style="list-style-type: none"> 1. See Using Chemicals/Cleaning Solvents in the Operation section. 2. Clean filter. See How To Clean Water Inlet Filter in Maintenance section. 3. Ensure end of chemical hose is fully submerged into chemical.
No or low pressure after a period of normal use.	<ol style="list-style-type: none"> 1. Worn seal or packing. 2. Worn or obstructed valves. 	<ol style="list-style-type: none"> 1. Have replaced by AWSC. 2. Have replaced by AWSC.
Water leaking at gun to wand connection	<ol style="list-style-type: none"> 1. Worn o-ring. 2. Loose hose connection. 	<ol style="list-style-type: none"> 1. Check and replace. 2. Tighten connection. If leak persists, disassemble connection, apply thread sealing tape to threads and reassemble
Water leaking at pump	<ol style="list-style-type: none"> 1. Loose connections. 2. Piston packings worn. 	<ol style="list-style-type: none"> 1. Tighten. 2. Have replaced by AWSC.
Oil leaking at pump	<ol style="list-style-type: none"> 1. Oil seals worn. 2. Loose drain plug. 3. Worn fill plug o-ring. 5. Pump overfilled. 5. Incorrect oil used. 	<ol style="list-style-type: none"> 1. Have replaced by AWSC. 2. Tighten. 3. Check and replace. 4. Check for correct amount. 5. Drain and fill with correct amount and type of oil.

REPAIR PARTS

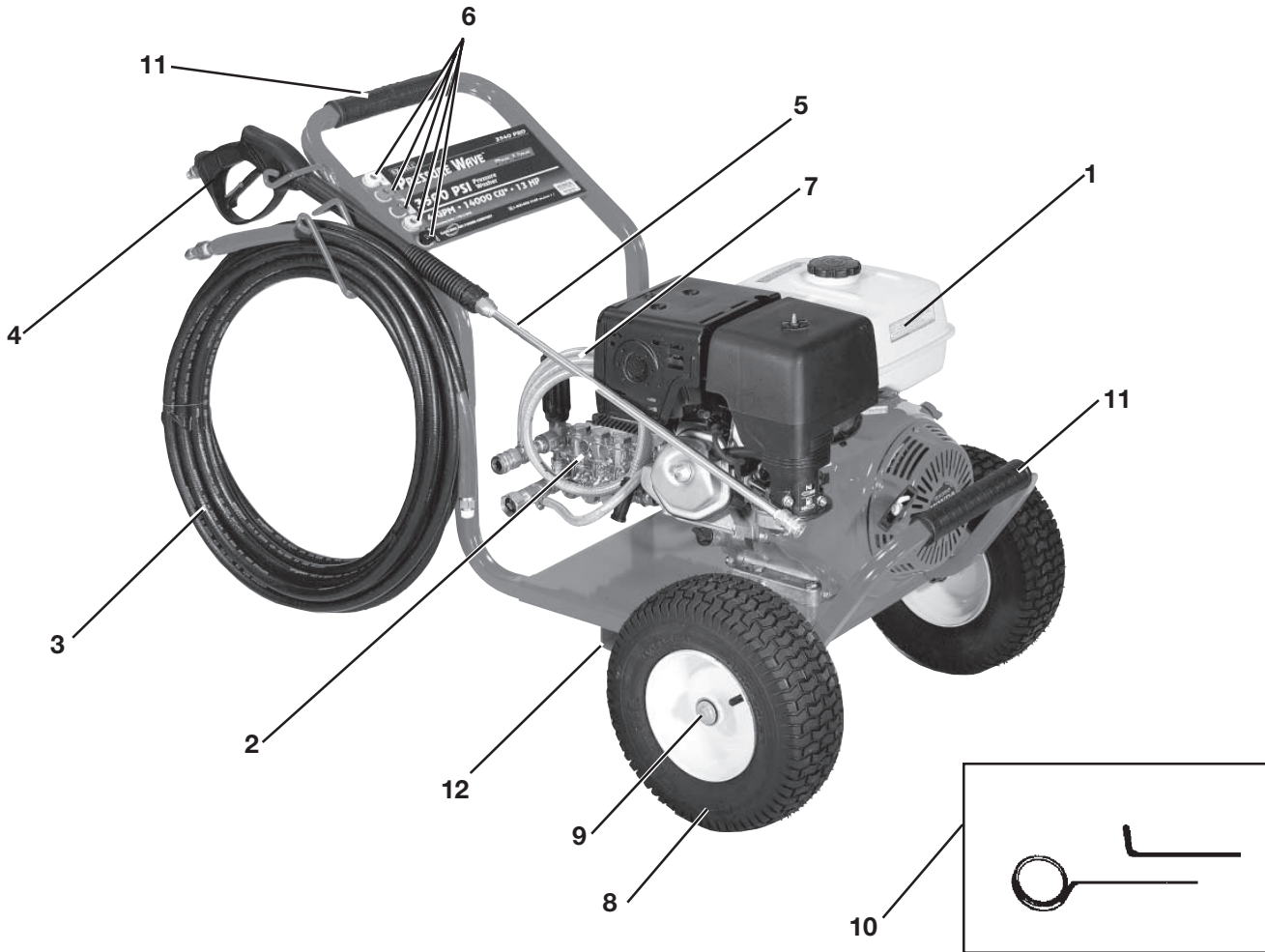

1	*	Honda Engine Model Number PS-GX-340K1QA
2	^	AR- Horizontal Pump
3	16756	High Pressure Hose
4	17698	Trigger Gun
5	17776	Wand with 22 mm adaptor
6	17730	Nozzle Kit includes 0°, 15°, 25°, 40°, and Chemical/Soap Nozzle
7	H100	Chemical Hose
8	17413	Tire
9	F464	Pal Nut
10	NCT001	Nozzle Cleaning Kit
11	17617	Handle Grip
12	17926	Foot (qty 2)

* Contact your local engine dealer for parts and service.

^ Contact an Authorized Warranty Service Center near you, call **1-800-888-2468, Ext. 2.**

NOTES

QUICK FACTS

Pressure Washer Quick Facts

CALL 1-800-888-2468 EXT. 2

**TO FIND A LOCAL AUTHORIZED SERVICE CENTER NEAR YOU
FOR REPAIRS AND SERVICE PART PURCHASES.**

GAS	Use fresh high quality gas. Add stabilizer to fuel tank and run engine for 5 minutes before storage.
OIL	Pump oil: Refer to owners manual supplied with this unit. Engine oil: Refer to engine manual supplied with this unit. Some units are equipped with a low oil sensor and adequate oil must be added or the unit will not start.
WATER	Use only cold water. Don't operate unit with clogged or missing water filter/screen. Don't operate unit without adequate water supply to pump. Adequate water supply is a minimum of 20 psi and 5 gpm.
PRESSURE ADJUSTMENT	The pressure setting is preset at the factory to achieve optimum cleaning. If you need to lower the pressure setting, refer to the owners manual for proper procedure.
PUMP	Pull gun trigger every 2 minutes while engine is running. Don't allow water to freeze in pump. Siphon RV antifreeze into pump for cold weather storage or long term storage.
BY-PASS MODE	Never leave unit running for more than 2 minutes without pulling gun trigger; doing so will destroy pump and void warranty.
THERMAL RELIEF VALVE	Pump is equipped with a thermal relief valve. If the water overheats, this valve will open and allow a gush of water to escape. Once the water is released, the valve closes allowing the pump to operate normally.
HOSE	Don't allow hoses to contact the HOT engine muffler during or after use. Never pull the hose to move the unit.
ENGINE	Do not adjust or attempt maintenance without consulting engine manual or an authorized engine service center. Add stabilizer to fuel tank and run engine for 5 minutes before storage. Always turn on the water before starting the engine.
SOAP CHEMICALS	Use only soaps and chemicals designed for pressure washer use.
NOZZLE	Keep nozzle unclogged. Refer to manual for cleaning procedures. Chemical/soap cannot be siphoned in high pressure setting. Only in low setting.
MAINTENANCE SCHEDULE	Follow recommended maintenance schedule for engine & pump. Refer to manuals.
STORAGE OR WINTER STORAGE	Draw clean water through chemical inlet. Add stabilizer to fuel tank and run engine for 5 minutes before storage. Don't allow water to freeze in pump, gun, wand or hoses. Siphon RV antifreeze into pump for cold weather storage or long term storage.

ALWAYS REFER TO THE MANUALS SUPPLIED WITH THIS UNIT