

Cub Cadet

Operator's Manual

High Pressure Washer

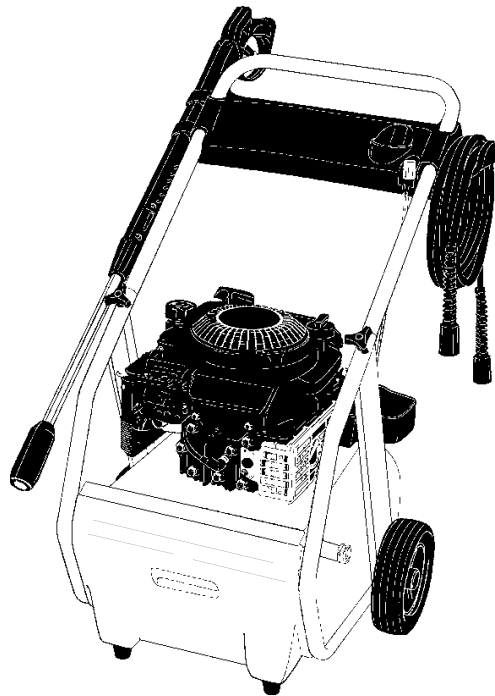

Model 2200H

IMPORTANT:
READ SAFETY RULES AND INSTRUCTIONS CAREFULLY
CUB CADET P.O. BOX 368023 CLEVELAND, OHIO 44136-9722 [www.cubcadet.com]
FORM NO. 770-10449
(9/00)

CONTENTS

Overview	3
Safe Operation Practices	3
Assembly Instructions	5
Operating Instructions	6
Using the Accessories	7
Working with Detergents	8
Shut Down and Clean-Up	9
Taking a Break	9
Winterizing and Long-Term Storage	9
Cleaning Tips	10
Optional Cleaning Accessories	11
Troubleshooting	12
Warranty	16

MODEL 2200H OVERVIEW

Specifications

Engine	6.0 HP Briggs & Stratton Quantum
Water volume	2.0 GPM
Operating pressure	2200 PSI

Item Description

1. Water inlet
2. Detergent tray w/screw
3. Knob Assembly (two)
4. Oil fill cap
5. High pressure hose
6. Detergent suction tube w/filter
7. Handle
8. Accessory rack
9. Trigger gun safety lock
10. Trigger gun
11. Pull start
12. Gas tank
13. Throttle
14. Choke
15. Wand w/adjustable spray nozzle
16. High pressure outlet (not pictured)

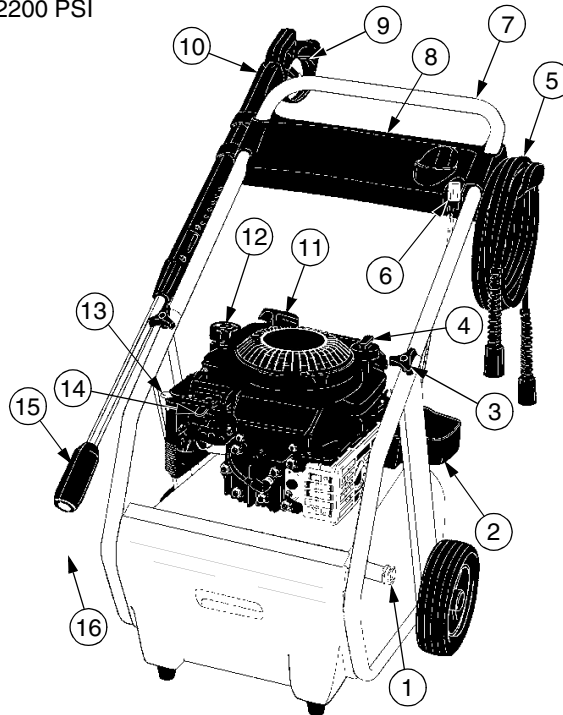

SAFE OPERATION PRACTICES — NEVER!

- Never** point nozzle at people or animals.
- Never** drink alcohol or use drugs while operating this equipment.
- Never** spray electrical connections, electrical outlets or fixtures.
- Never** add fuel with the engine running or operate where fuel has been spilled.
- Never** touch hot surfaces or allow accessories to contact hot surfaces.
- Never** operate in an enclosed space, exhaust fumes are dangerous.
- Never** operate near utilities with open flames.
- Never** operate without the water turned on and never use hot water.

SAFE OPERATION PRACTICES – Read First!



Safety Warnings

When using this product basic precautions should always be followed:

- Read all the instructions before using the product.
- **FIRE HAZARD!** Do not add fuel with the engine running. Do not operate if fuel has been spilled. Instead move the machine to a different location and avoid creating sparks.
- Operate and fuel machine in a well ventilated area, free of devices featuring an open pilot or flame such as boilers, water heaters, etc.
- High pressure jets can be dangerous if subject to misuse. The jet must not be directed at persons, animals, electrical devices or the machine itself.
- Wear safety goggles.
- Do not use acids, solvents, or any other flammable material in this product. These products can cause physical injuries to the operator and irreversible damage to the machine. If you have further questions regarding the use of recommended cleaning detergent, please call your Cub Cadet dealer.
- The machine has hot surfaces which can cause burns. Operate the unit in a safe environment and away from children.
- Do not allow the high pressure hose to come into contact with the muffler guard.
- Do not leave the machine running unattended.
- Learn how to stop the machine and release pressure quickly. Be thoroughly familiar with the controls.
- Stay alert — watch what you are doing.
- Do not operate the product when fatigued or under the influence of alcohol or drugs.
- Do not stand on unstable surfaces. Stand with both feet balanced at all times.
- The Gun Safety Lock PREVENTS the trigger from accidentally being engaged. This safety feature DOES NOT lock the trigger in the on position.

Water Supply (Cold Water Only)

- Water hose must be at least 3/4 inch in diameter.
- Flow rate of water supply must not fall below 2.5 GPM (gallons per minute).
- Flow rate can be determined by running the water for one minute into an empty 5-gallon container.
- The water supply temperature must not exceed 104°F/40°C.
- Never use the pressure washer to draw in water contaminated with solvents, e.g. paint thinners, gasoline, oil, etc.
- Always prevent debris from being drawn into the unit by using a clean water source.

We strongly recommend that this high pressure washer not be left running for periods of 5 minutes or longer without the trigger gun being engaged.

This high pressure washer is equipped with thermal protection to extend the life of your pressure washer. The thermal protector will automatically activate at a predetermined temperature ejecting hot water before resetting. This ensures that the pump does not become damaged.



Caution

- Follow the maintenance instructions specified in the manual.
- This machine has been designed for use with cleaning detergent supplied or recommended by the manufacturer. The use of other cleaning detergents may affect the operation of the machine and void the warranty.

ASSEMBLY INSTRUCTIONS

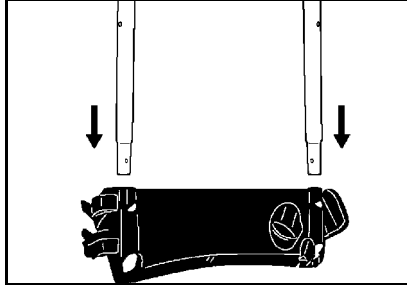

Step1 Slide the handle through the accessory rack.

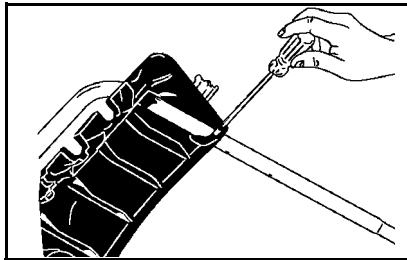

Step2 Align the holes of the accessory rack to the handle and fasten the four screws.

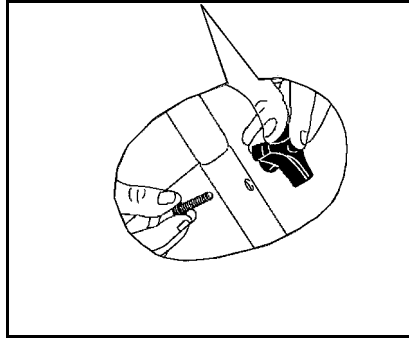
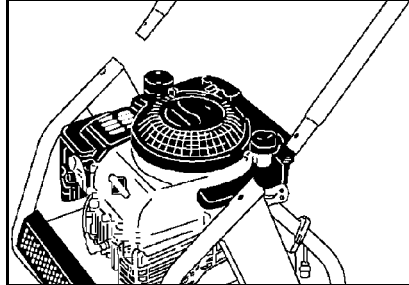

Step3 Insert the handle into the frame. Align holes, insert bolt, and tighten with knob.

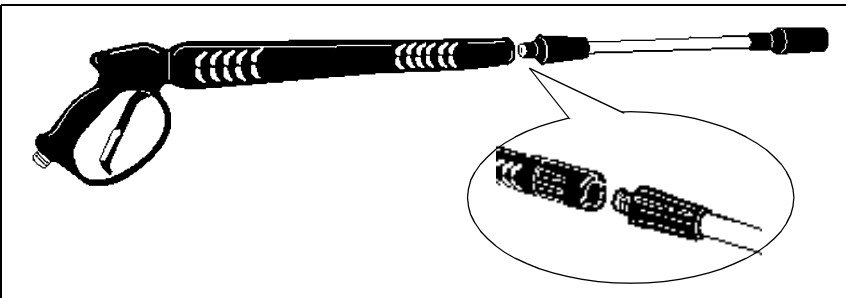

Step4 Insert the spray wand into the gun. Push in and turn clockwise to lock spray wand in place. Turn the wand collar clockwise onto the spray wand threads until tight.

Step5 Attach high pressure hose to trigger gun.

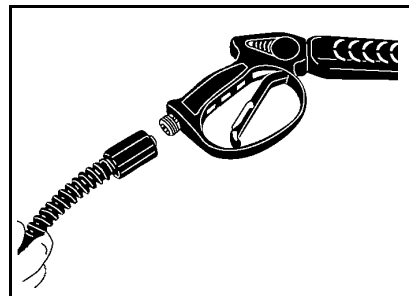

OPERATING INSTRUCTIONS

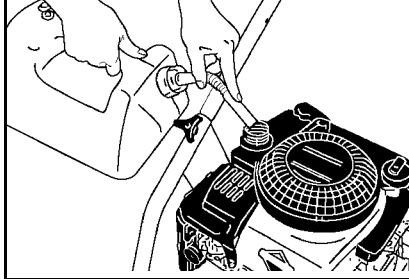

Step1 Fill gas tank with unleaded gasoline. Do not use leaded gasoline.

Important! Do not run the engine with a high or low oil level as this can cause engine damage. If you have further questions regarding the engine, please refer to the engine's operating manual included with the unit.

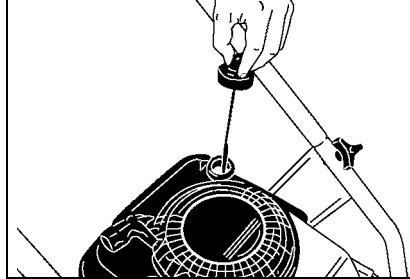

Step2 Check oil level. Oil level should always be between the "FULL" and "ADD" marks on the dipstick. Be sure the machine is level when checking the oil level. (Refer to the engine's operating manual for seasonal grades).

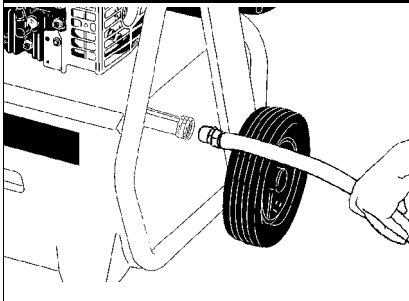

Step3 Connect garden hose to unit's water inlet.

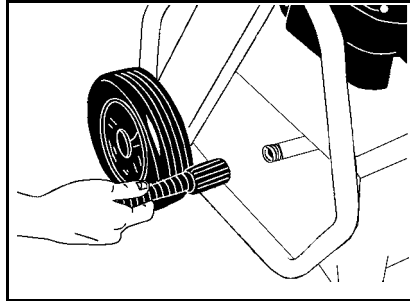

Step4 Connect high pressure hose to high pressure outlet.

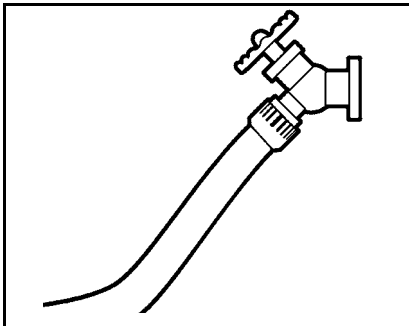

Step5 Connect garden hose to the cold water source and turn water on completely.

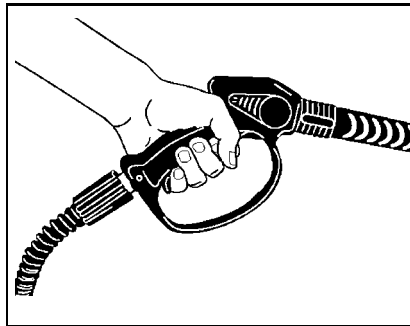

Step6 Trigger the gun to eliminate trapped air, wait for a steady flow of water to emerge from the spray nozzle.

OPERATING INSTRUCTIONS - continued

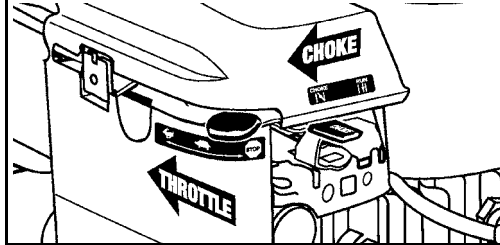

Step7 Slide the throttle control to the fast position. Move the choke lever to the "CHOKE" position (only if the engine is cool). After starting, move the choke to "RUN".

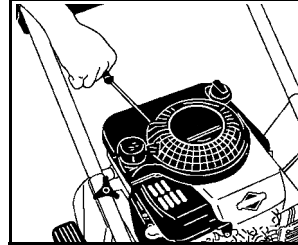

Step8 Pull the starter handle. If the engine fails to start after 3 pulls squeeze the trigger gun to release pressure, and repeat step 8.

USING THE ACCESSORIES

Spray Wand

The spray wand allows you to adjust the cleaning pressure. To clean at maximum pressure, the wand must be positioned to the high pressure setting (+). To apply detergent, the wand must be positioned to the low pressure setting (-).

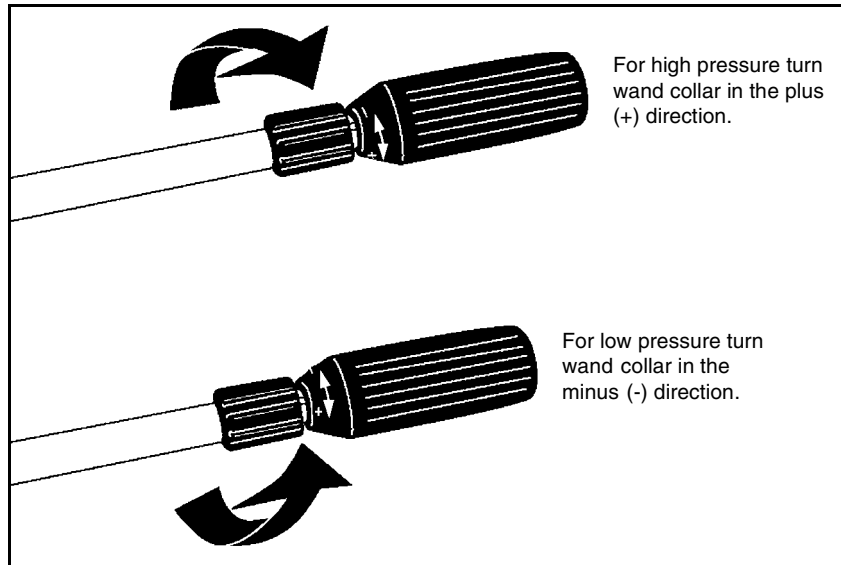

WARNING: TO AVOID SERIOUS INJURY, NEVER POINT SPRAY NOZZLE AT YOURSELF, OTHER PERSONS OR ANIMALS

WORKING WITH DETERGENT

Detergents can only be applied in the "low" setting.

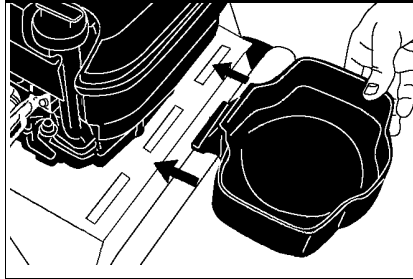

Step1 Slide the detergent tray into one of the slots of your choice. Secure the tray to the frame by fastening the screw.

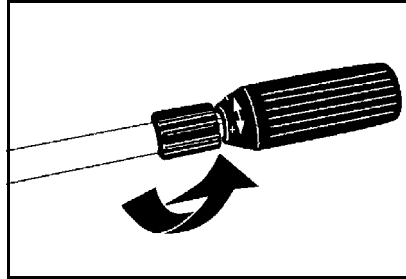

Step2 The wand must be set in the low pressure (-) position to apply detergents.

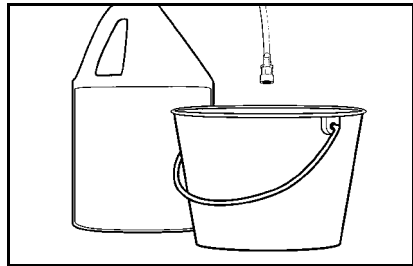

Step3 Fill a container with Cub Cadet detergent. Place the filter end of detergent suction tube into the container. Be sure to adjust the filter by turning it to the desired detergent intake.

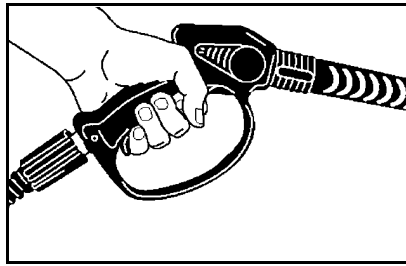

Step4 With the engine running, pull trigger to operate unit: Liquid detergent is drawn into the unit and mixed with water. Apply detergent to work area. Do not allow detergent to dry on surface.

For best results see Cleaning Tips on pages 9 & 10 for specific information on how to clean different surfaces.



Caution

Never use:

- Bleach, Chlorine products and other corrosive chemicals
- Liquids containing solvents (i.e., paint thinners, gasoline, oils)
- Tri-sodium phosphate products
- Ammonia products
- Acid-based products

These chemicals will harm the unit and will damage the surface being cleaned.

Always Use Cub Cadet Detergents for Best Results.

Cub Cadet biodegradable detergents are specially formulated to protect the environment and your pressure washer. Special formula won't clog the suction tube filter and will protect the internal parts of the pressure washer for a longer life. For Cub Cadet Detergents, check your local Cub Cadet dealer. If you need help locating a dealer in your area, contact the Customer Dealer Referral Line by calling:

1-877-835-7841

One gallon container of the following Cub Cadet detergents are available:

- Vehicle Wash Part No. KR-9103501
- Deck Wash Part No. KR-9103502
- Degreaser Part No. KR-9103503
- All Purpose Cleaner Part No. KR-9103504

SHUTTING DOWN & CLEAN-UP

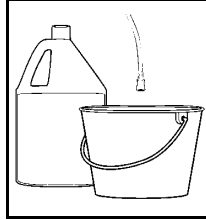

Step1 Remove detergent suction tube from container and insert into one gallon of fresh water. Siphon water at low pressure for one minute.

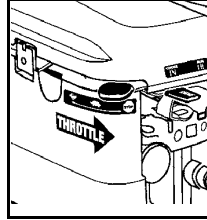

Step2 Turn off the engine.

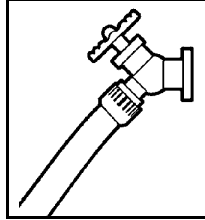

Step3 Turn off the water source.

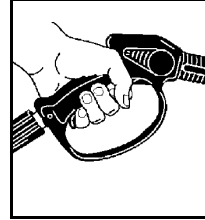

Step4 Press trigger to release water pressure.

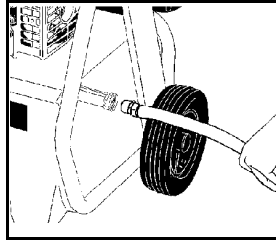

Step5 Disconnect the garden hose from the water inlet on the unit.

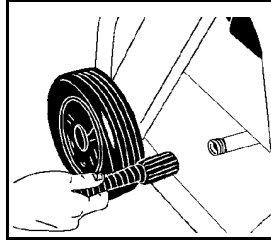

Step6 Disconnect the high pressure hose from the high pressure outlet and engage the gun safety lock.

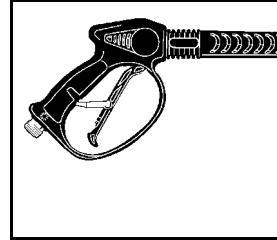

TAKING A BREAK... five minutes or more

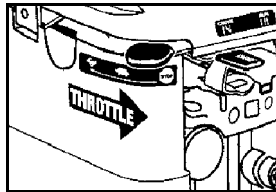

Step1 Turn off the engine.

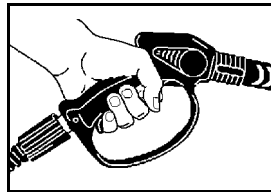

Step2 Press trigger to release water pressure.

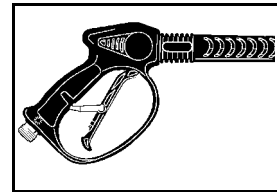

Step3 Engage gun safety lock.

WINTERIZING AND LONG-TERM STORAGE

1. Disconnect all water connections.
2. Start the machine for a few seconds, until the water which had remained in the pump exits. Turn off immediately.
3. Drain the gas and oil from the engine.
4. Do not allow high pressure hose to become kinked.
5. Store the machine and accessories in a room which does not reach freezing temperatures. The machine should not be placed near an open flame i.e. furnace, hot water heater etc.

Caution: Failure to follow the above directions will result in damage to the pump assembly and accessories.

CLEANING TIPS

Deck Cleaning

(with or without detergent)

Pre-rinse deck and surrounding area with fresh water. If using Cub Cadet Deck Wash, place detergent suction tube directly into cleaning solution and apply to surface at low pressure. For best results, limit your work area to smaller sections of approximately 25 square feet. Allow Cub Cadet Deck Wash to remain on surface 1-3 minutes. Do not allow detergent to dry on surface. Rinse at high pressure in a long sweeping motion keeping the spray nozzle approximately 3-6 inches from the cleaning surface. Always clean from top to bottom and from left to right. When moving on to a new section of the cleaning surface, be sure to overlap the previous section to eliminate stop marks and ensure a more even cleaning result.

Caution: Do not use rotating nozzle spray wand on wood surface as it may cause damage.

House Siding

(with or without detergent)

Pre-rinse cleaning surface with fresh water. If using Cub Cadet All Purpose Cleaner, place detergent suction tube directly into cleaning solution and apply to surface at low pressure (for best results, limit your work area to sections of approximately 6 feet and always apply detergent from bottom to top). Allow Cub Cadet All Purpose Cleaner to remain on surface 1-3 minutes. Do not allow detergent to dry on surface, if surface appears to be drying, simply wet down surface with fresh water. If needed, use special Wash Brush Attachment to remove stubborn dirt. Rinse at high pressure from top to bottom in an even sweeping motion keeping the spray nozzle approximately 6 inches from the cleaning surface.

Caution: Do not use rotating nozzle spray wand on siding as it may cause damage.

Cement Patios,

Brick and Stone

(with or without detergent)

Pre-rinse cleaning surface with fresh water. If using Cub Cadet All Purpose Cleaner, place detergent suction tube directly into cleaning solution and apply to surface at low pressure. For best results, limit your work area to smaller sections of approximately 25 square feet. Allow Cub Cadet All Purpose Cleaner to remain on surface 1-3 minutes. Do not allow detergent to dry on surface. Rinse at high pressure in a sweeping motion keeping the spray nozzle approximately 3-6 inches from the cleaning surface. Always clean from top to bottom and from left to right.

For removing extremely stubborn stains, use the Cub Cadet Rotating Nozzle Spray Wand.

Cars, Boats & Motorcycles

(with or without detergent)

Pre-rinse vehicle with fresh water. If using Cub Cadet Vehicle Wash, place detergent suction tube directly into cleaning solution and apply to surface at low pressure. For best results, clean one side of vehicle at a time and always apply detergent from bottom to top, do not allow detergent to dry on surface. If needed, use special Wash Brush Attachment to remove stubborn dirt. Rinse at high pressure in a sweeping motion keeping the spray nozzle approximately 6-8 inches from the cleaning surface (distance should increase when rinsing pin-striping or other sensitive surfaces). Always clean from top to bottom and from left to right. For best results, wipe surface dry with a chamois or soft dry cloth.

Caution: Do not use rotating nozzle spray wand on vehicles as it may cause damage.

CLEANING TIPS - continued

Barbecue Grills, Outdoor Power Equipment & Gardening Tools

(with or without detergent)

Pre-rinse cleaning surface with fresh water. If using Cub Cadet All Purpose Cleaner or Degreaser, place detergent suction tube directly into cleaning solution and apply detergent at low pressure. Allow Cub Cadet detergent to remain on surface 1-3 minutes. Do not allow detergent to dry on surface. Rinse at high pressure keeping the spray nozzle approximately 3-6 inches from the cleaning surface. For removing extremely stubborn dirt, it may be necessary to move the spray nozzle even closer to the surface for greater dirt cutting action. To remove caked on mud from garbage cans, lawn mower blades, wheel barrels or other non-sensitive metal surfaces, you may want to use the Cub Cadet Rotating Nozzle Spray Wand.

Caution: Do not use rotating nozzle spray wand on cloth, plastic or other sensitive surfaces as it may cause damage.

Patio & Lawn Furniture

(with or without detergent)

Pre-rinse furniture and surrounding area with fresh water. If using Cub Cadet All Purpose Cleaner, place detergent suction tube directly into cleaning solution and apply to surface at low pressure. Allow Cub Cadet All Purpose Cleaner to remain on surface 1-3 minutes. Do not allow detergent to dry on surface. If needed use special Wash Brush Attachment to remove stubborn dirt. Rinse at high pressure in a sweeping motion keeping the spray nozzle approximately 3-6 inches from the cleaning surface. For best results, clean from top to bottom and from left to right. Caution: Do not use rotating nozzle spray wand on patio or lawn furniture as it may cause damage.

Recommendations

- Before cleaning any surface an inconspicuous area should be cleaned to test spray pattern and distance for maximum cleaning results.
- If painted surfaces are peeling or chipping, use extreme caution as pressure washer may remove the loose paint from the surface.

OPTIONAL CLEANING ACCESSORIES

To further enhance your cleaning capabilities, optional cleaning accessories are available from your local Cub Cadet dealer:

- | | |
|-----------------------|---------------------|
| • Rotating Wash Brush | Part No. KR-9103105 |
| • Wash Brush | Part No. KR-9103106 |
| • Rotating Spray Wand | Part No. KR-9103301 |
| • Extension Hose 25' | Part No. KR-9103006 |
| • Plastic Hose Reel | Part No. KR-9103053 |

If you need help locating a dealer in your area, contact the Customer Dealer Referral Line by calling:

1-877-835-7841

TROUBLESHOOTING

Symptom	Cause	Solution
Engine will not start For additional engine problems refer to the engine owners manual.	No gasoline.	Fill gas tank.
	Low oil level.	Add oil.
	Choke is not in correct position.	Slide choke lever to "CHOKE" position.
	Engine throttle is not in correct position.	Position the throttle to "FAST".
	Pressure built up in the high pressure washer.	Squeeze the trigger to release the pressure.
Unit does not reach high pressure.	Diameter of garden hose is too small.	Replace with a 3/4 inch garden hose.
	Water supply is restricted.	Check garden hose for kinks, leaks and blockage.
	Not enough inlet water supply	Open water source full force.
	Water inlet filter is clogged.	Remove filter and rinse out in warm water.
	Spray wand is in low pressure position.	Turn spray wand tip to high pressure position.
Output pressure varies high and low.	Not enough inlet water supply.	Turn water on full force. Check garden hose for kinks, leaks or blockage.
	Pump is sucking air.	Check that hoses and fittings are air tight. Turn off machine and purge pump by squeezing trigger gun until a steady flow of water emerges through the nozzle.
	Water inlet filter is clogged.	Remove filter and rinse out in warm water.
	Discharge nozzle is obstructed.	Blow out or remove debris with a fine needle.
	Calcified gun, hose or spray wand.	Run distilled vinegar through detergent suction tube.

TROUBLESHOOTING - continued

Symptom	Cause	Solution
No detergent.	Detergent suction tube not properly connected to the machine.	Check connection.
	Detergent is too thick.	Dilute detergent, for best results use Cub Cadet detergent.
	The filter is closed.	Open the filter by turning it to the desired detergent intake.
	Filter on detergent suction tube is clogged.	Run warm water through filter to remove debris.
	Damaged or clogged detergent suction tube.	Remove obstruction or replace detergent suction tube.
	Spray wand is in high pressure position.	Turn spray wand tip to low pressure position.
	Discharge nozzle is obstructed.	Blow out or remove debris with a fine needle.
Garden hose connection leaks.	Loose fittings.	Tighten fittings.
	Missing/worn rubber washer.	Insert new washer.
Spray wand or Spray extension wand leaks.	Spray wand not properly attached.	Insert the spray wand into the spray wand extension. Carefully press in against the spring tension and twist into the locked position.
	Spray wand extension not properly attached.	Slide the spray wand extension into the gun. Turn the wand collar clockwise onto the gun threads until tight.
	Broken o-ring or plastic insert.	Contact your local Cub Cadet dealer.
Pump is noisy.	Pump is sucking air.	Check that hoses and fittings are air tight. Turn off machine and purge pump by squeezing trigger gun until a steady flow of water emerges through the nozzle.
Water leaks from pump (up to 10 drops per minute is permissible).	Loose fittings.	Check that all fittings are tight.
	Thermal protection device has been activated.	Thermal protection device will automatically reset.
	Water seals are damaged or worn.	Contact your local Cub Cadet dealer.
Oil Drip.	Oil seals are damaged or worn.	Contact your local Cub Cadet dealer.

- If you encounter any additional difficulties not listed, please contact your local Cub Cadet dealer.



**MANUFACTURER'S LIMITED WARRANTY
for PRESSURE WASHERS
(RESIDENTIAL LINE)**

The limited warranty set forth below is given by CUB CADET with respect to new merchandise purchased and used in the United States, its possessions and territories.

CUB CADET warrants this product against defects in material and workmanship for a period of **one (1) year** for residential users, commencing on the date of original purchase and will, at its option, repair or replace, free of charge, any part found to be defective in material or workmanship. This limited warranty shall only apply if this product has been operated and maintained in accordance with the Operator's Manual furnished with the product, and has not been subject to misuse, abuse, neglect, accident, improper maintenance, improper storage or handling, freezing, use of improper chemicals, alterations, vandalism, theft, fire, water, or damage because of other peril or natural disaster. Damage resulting from the installation or use of any accessory or attachment not approved by Cub Cadet for use with the product(s) covered by this manual will void your warranty as to any resulting damages. The following parts and accessories are subject to separate terms as follows: Limited Warranty: 90-day free replacement for defects in materials and/or workmanship on hoses, hose reels, spray wands, brushes, nozzles and/or similar approved accessories.

HOW TO OBTAIN SERVICE: Warranty service is available, WITH PROOF OF PURCHASE, THROUGH YOUR LOCAL AUTHORIZED CUB CADET or CUB CADET COMMERCIAL DEALER. To locate the dealer in your area, please check for a listing in the Yellow Pages or contact CUB CADET by calling 877-835-7841 or writing to PO BOX 368023, Cleveland, Ohio 44136-9723.

This limited warranty does not provide coverage in the following cases:

- (a) Routine maintenance items such as lubricants, filters, tune-ups, or adjustments.
- (b) Equipment setup, normal wear parts or components.
- (c) CUB CADET does not extend any warranty for products sold or exported outside of the United States, its possessions, and territories.

No implied warranty, including any implied warranty of merchantability or fitness for a particular purpose, applies after the applicable period of express written warranty above. No other express warranty or guaranty, whether written or oral, except as mentioned above, given by any person or entity, including the dealer with respect to any product shall bind CUB CADET. During the period of the Warranty, the exclusive remedy is repair or replacement of the product as set forth above. (Some states do not allow limitations on how long an implied warranty lasts, so the above limitation may not apply to you.)

The provisions as set forth in this Warranty provide the sole and exclusive remedy arising for the sale. CUB CADET shall not be liable for incidental or consequential loss or damages including, without limitation, to any claim for loss of profits, loss of savings or revenue, loss of the use of the equipment or any associated equipment, facilities or service, downtime, the claims or costs of third parties including customers, and injury to property, and further including expenses incurred for substitute or replacement property care services, for transportation or for related expenses, or for rental expenses to temporarily replace a warranted product. (Some states do not allow the exclusion or limitation of incidental or consequential damages, so the above exclusion may not apply to you.)

In no event shall recovery of any kind be greater than the amount of the purchase price of the product sold. Alteration of the safety features of the product shall void this warranty. You assume the risk and liability for loss, damage, or injury to you and your property and/or to others and their property arising out of use or misuse or inability to use this product.

This limited warranty shall not extend to anyone other than the original purchaser or original lessee, or the person for whom it was purchased as a gift.

HOW STATE LAW RELATES to this WARRANTY: This limited warranty gives you specific legal rights, and you may also have other rights which vary from state to state.