

PKV401T

INSTRUCTIONS FOR USE
MANUEL D'UTILISATION
MANUAL DE INSTRUCCIONES

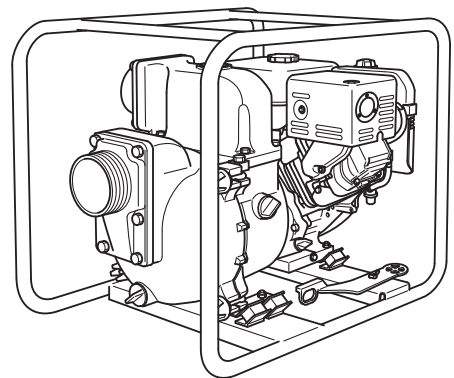

9ZZ9990043

北米

Robin Pump

1

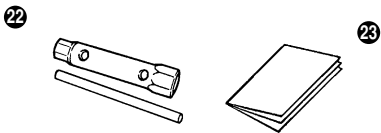
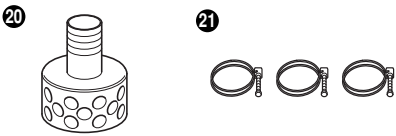
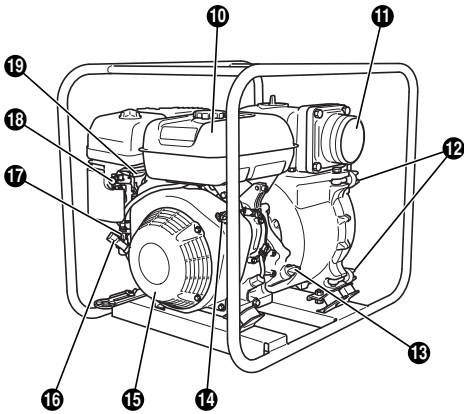
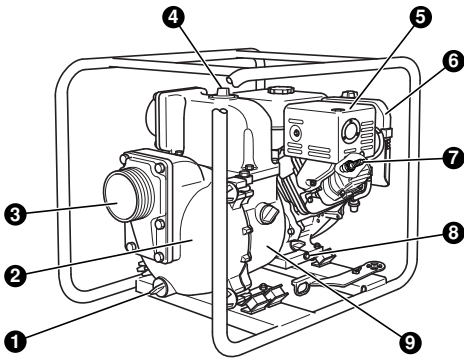

2

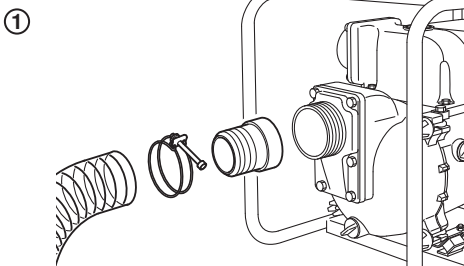

2

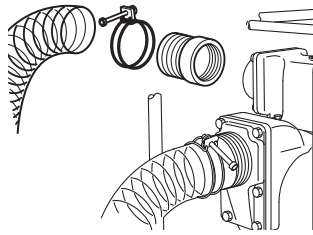

3

	SW							
Single grade		10W		20W		#20		#30
								#40
Multi grade		10W-30		10W-40				
Ambient temperature	-20	-10	0	10	20	30	40 °C	
	-4	14	32	50	68	86	104 °F	

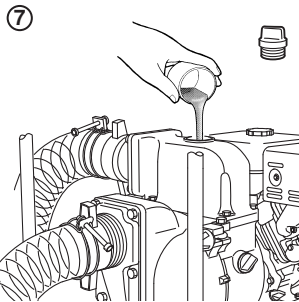
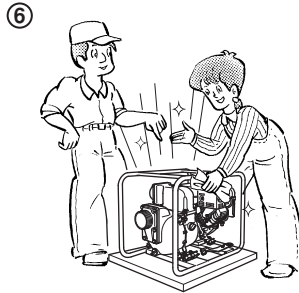
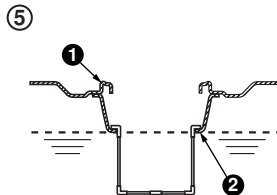
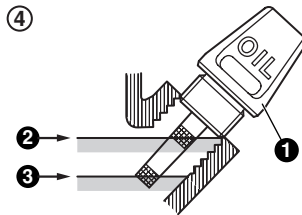

3

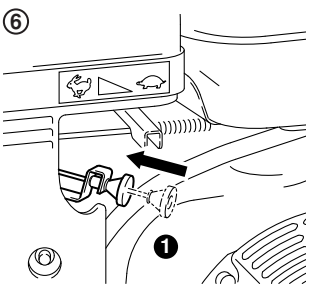
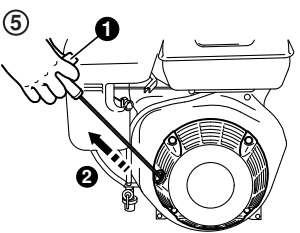
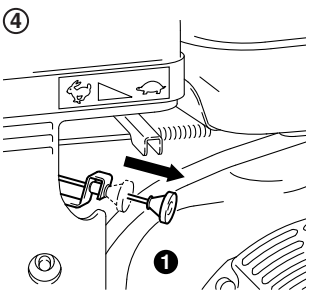
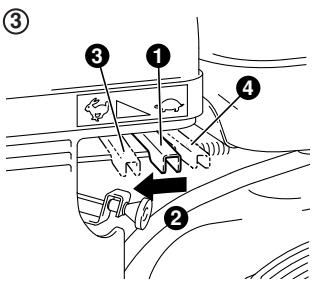
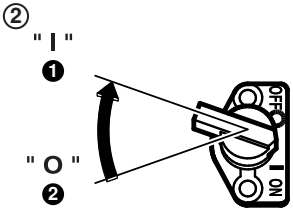
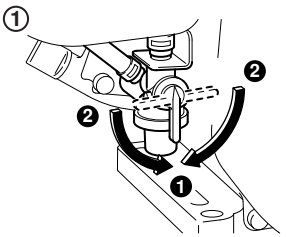

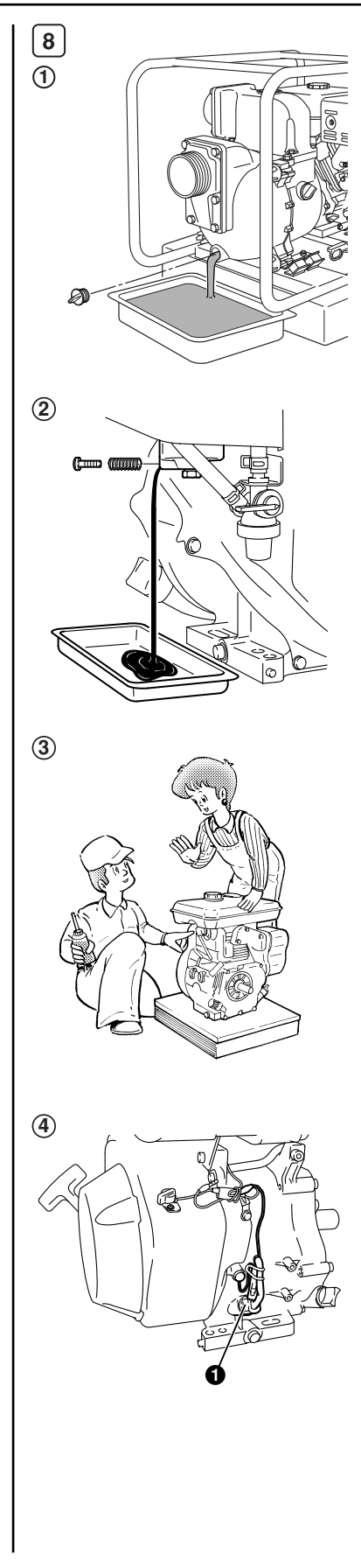
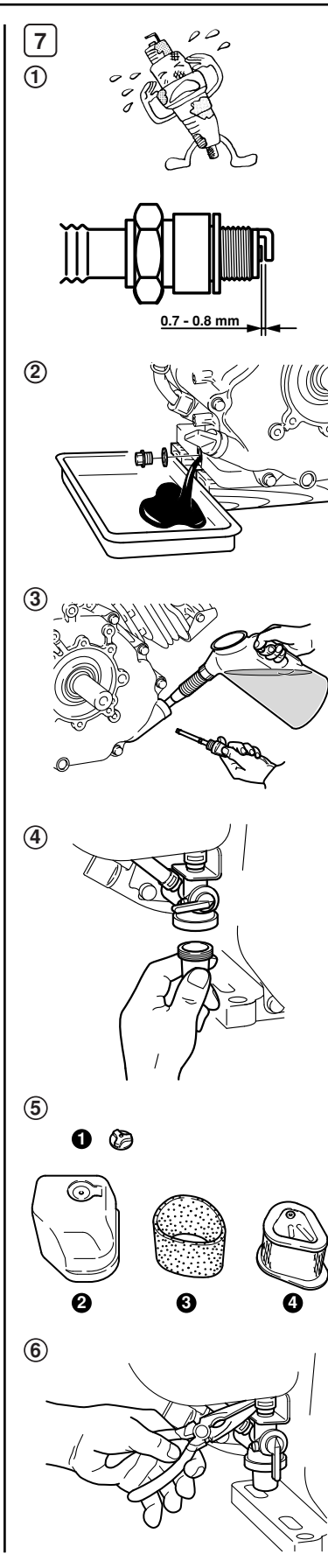
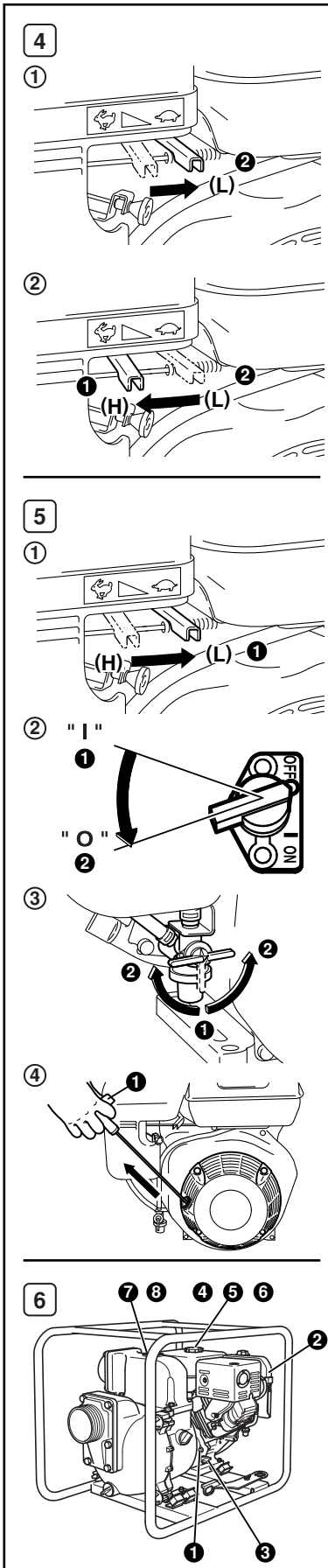

**WARNING:**

The engine exhaust from this product contains chemicals known to the State of California to cause cancer, birth defects or other reproductive harm.

NOTICE

FEDERAL EMISSION COMPONENT DEFECT WARRANTY and CALIFORNIA EMISSION CONTROL WARRANTY are applicable to only those engines/generators complied with EPA (Environmental Protection Agency) and CARB (California Air Resources Board) emission regulations in the U.S.A.

NOTICE

To the engines/generators exported to and used in the countries other than the U.S.A., warranty service shall be performed by the distributor in each country in accordance with the standard Robin engine/generator warranty policy as applicable.

AIR INDEX

To show compliance with California emission regulations, a hangtag has been provided displaying the Air Index level and durability period of this engine.

The Air Index level defines how clean an engine's exhaust is over a period of time. A bar graph scaled from "0" (most clean) to "10" (least clean) is used to show an engine's Air Index level. A lower Air Index level represents cleaner exhaust from an engine.

The period of time (in hours) that the Air Index level is measured is known as the durability period. Depending on the size of the engine, a selection of time periods can be used to measure the Air Index level (see below).

<u>Descriptive Term</u>	<u>Applicable to Emissions Durability Period</u>
Moderate	- 50 hours (engine from 0 to 80 cc) 125 hours (engine greater than 80 cc)
Intermediate	- 125 hours (engine from 0 to 80 cc) 250 hours (engine greater than 80 cc)
Extended	- 300 hours (engine from 0 to 80 cc) 500 hours (engine greater than 80 cc)

Notice : This hangtag must remain on this engine or piece of equipment, and only be removed by the ultimate purchaser before operation.

FEDERAL EMISSIONS COMPONENT DEFECT WARRANTY

EMISSIONS COMPONENT DEFECT WARRANTY COVERAGE – This emission warranty is applicable in all States, except the state of California.

Fuji Heavy Industries Ltd. and Robin America Inc., Wood Dale Illinois, (herein "ROBIN AMERICA") warrant(s) to the initial retail purchaser and each subsequent owner, that this Nonroad engine (herein "engine") has been designed, built, and equipped to conform at the time of initial sale to all applicable regulations of the U.S.

Environmental Protection Agency (EPA), and that the engine is free of defects in materials and workmanship which would cause this engine to fail to conform with EPA regulations during its warranty period.

For the components listed under PARTS COVERED, the service dealer authorized by ROBIN AMERICA will, at no cost to you, make the necessary diagnosis, repair, or replacement necessary to ensure that the engine complies with applicable U.S. EPA regulations.

EMISSION COMPONENT DEFECT WARRANTY PERIOD

The warranty period for this engine begins on the date of sale to the initial purchaser and continues for a period of two years.

PARTS COVERED

Listed below are the parts covered by the Emission Components Defect Warranty. Some of the parts listed below may require scheduled maintenance and are warranted up to the first scheduled replacement point for that part.

- (1) Fuel Metering System
 - (i) Carburetor and internal parts (and/or pressure regulator or fuel injection system).
 - (ii) Air/fuel ratio feedback and control system, if applicable.
 - (iii) Cold start enrichment system, if applicable.
 - (iv) Regulator assy (gaseous fuel, if applicable)
- (2) Air Induction System
 - (i) Intake manifold, if applicable
 - (ii) Air filter.
- (3) Ignition System
 - (i) Spark plugs.
 - (ii) Magneto or electronic ignition system.
 - (iii) Spark advance/retard system, if applicable.
- (4) Exhaust manifold, if applicable
- (5) Miscellaneous Items Used in Above Systems
 - (i) Electronic controls, if applicable
 - (ii) Hoses, belts, connectors, and assemblies.
 - (iii) Filter lock assy (gaseous fuel, if applicable)

OBTAINING WARRANTY SERVICE

To obtain warranty service, take your engine to the nearest authorized Robin America service dealer. Bring your sales receipts indicating date of purchase for this engine. The service dealer authorized by ROBIN AMERICA will perform the necessary repairs or adjustments within a reasonable amount of time and furnish you with a copy of the repair order. All parts and accessories replaced under this warranty become the property of ROBIN AMERICA.

WHAT IS NOT COVERED

*Conditions resulting from tampering, misuse, improper adjustment (unless they were made by the service dealer authorized by ROBIN AMERICA during a warranty repair), alteration, accident, failure to use the recommended fuel and oil, or not performing required maintenance services.

*The replacement parts used for required maintenance services.

*Consequential damages such as loss of time, inconvenience, loss of use of the engine or equipment, etc.

*Diagnosis and inspection charges that do not result in warranty-eligible service being performed.

*Any non-authorized replacement part, or malfunction of authorized parts due to use of non-authorized parts.

OWNER'S WARRANTY RESPONSIBILITIES

As the engine owner, you are responsible for the performance of the required maintenance listed in your owner's manual. ROBIN AMERICA recommends that you retain all receipts covering maintenance on your engine, but ROBIN AMERICA cannot deny warranty solely for the lack of receipts or for your failure to ensure the performance of all scheduled maintenance.

As the engine owner, you should however be aware that ROBIN AMERICA may deny warranty coverage if your engine or a part has failed due to abuse, neglect, improper maintenance or unapproved modifications.

You are responsible for presenting your engine to the nearest service dealer authorized by ROBIN AMERICA when a problem exists.

If you have any questions regarding your warranty rights and responsibilities, you should contact the Robin America customer service department at 1-630-350-8200 for the information.

THINGS YOU SHOULD KNOW ABOUT THE EMISSION CONTROL SYSTEM WARRANTY MAINTENANCE AND REPAIRS

You are responsible for the proper maintenance of the engine. You should keep all receipts and maintenance records covering the performance of regular maintenance in the event questions arise. These receipts and maintenance records should be transferred to each subsequent owner of the engine. ROBIN AMERICA reserves the right to deny warranty coverage if the engine has not been properly maintained. Warranty claims will not be denied, however, solely because of the lack of required maintenance or failure to keep maintenance records.

MAINTENANCE, REPLACEMENT OR REPAIR OF EMISSION CONTROL DEVICES AND SYSTEMS MAY BE PERFORMED BY ANY REPAIR ESTABLISHMENT OR INDIVIDUAL; HOWEVER, WARRANTY REPAIRS MUST BE PERFORMED BY A SERVICE DEALER AUTHORIZED BY ROBIN AMERICA. THE USE OF PARTS THAT ARE NOT EQUIVALENT IN PERFORMANCE AND DURABILITY TO AUTHORIZED PARTS MAY IMPAIR THE EFFECTIVENESS OF THE EMISSION CONTROL SYSTEM AND MAY HAVE A BEARING ON THE OUTCOME OF A WARRANTY CLAIM.

If other than the parts authorized by ROBIN AMERICA are used for maintenance replacements or for the repair of components affecting emission control, you should assure yourself that such parts are warranted by their manufacturer to be equivalent to the parts authorized by ROBIN AMERICA in their performance and durability.

HOW TO MAKE A CLAIM

All repair qualifying under this limited warranty must be performed by a service dealer authorized by ROBIN AMERICA. In the event that any emission-related part is found to be defective during the warranty period, you shall notify Robin America customer service department at 1-630-350-8200 and you will be advised of the appropriate warranty service dealer or service providers where the warranty repair can be performed.

CALIFORNIA EMISSIONS CONTROL WARRANTY STATEMENT

YOUR WARRANTY RIGHTS AND OBLIGATIONS

The California Air Resources Board and Fuji Heavy Industries Ltd. (herein "FUJI") are pleased to explain the emissions control system warranty on your small off-road engine (SORE). In California, new SOREs must be designed, built and equipped to meet the State's stringent anti-smog standards. FUJI must warrant the emissions control system on your SOREs for the periods of time listed below provided there has been no abuse, neglect or improper maintenance of your SOREs.

Your emissions control system may include parts such as the carburetor or fuel-injection system, fuel lines and the ignition system. Also included may be hoses, clamps, connectors and other associated components.

Where a warrantable condition exist, Fuji will repair your small off-road engine at no cost to you including diagnosis, parts and labor.

MANUFACTURER'S WARRANTY COVERAGE:

This emissions control system is warranted for two years. If any emissions-related part on your engine is defective, the part will be repaired or replaced by FUJI.

OWNER'S WARRANTY RESPONSIBILITIES:

-As the SORE owner, you are responsible for performance of the required maintenance listed in your owner's manual. FUJI recommends that you retain all receipts covering maintenance on your SORE, but FUJI cannot deny warranty solely for the lack of receipts.

-As the SORE owner, you should however be aware that FUJI may deny you warranty coverage if your SORE or a part has failed due to abuse, neglect, or improper maintenance or unapproved modifications.

-You are responsible for presenting your SORE to distribution center or service center authorized by ROBIN AMERICA Inc. 940 Lively Blvd., Wood Dale, IL 60191 (herein ROBIN AMERICA) as soon as the problem exists. The warranty repairs should be completed in a reasonable amount of time, not to exceed 30 days.

If you have a question regarding your warranty coverage, you should contact the Robin America Inc. Customer Service Department at 1-630-350-8200.

GENERAL EMISSIONS WARRANTY COVERAGE – California Only –

FUJI warrants to the ultimate purchaser and each subsequent purchaser that the SORE (1) has been designed, built and equipped so as to conform with all applicable regulations; and (2) is free from defects in materials and workmanship that cause the failure of a warranted part to conform with those regulations as may be applicable to the terms and conditions stated below.

- (a) The warranty period begins on the date the engine is delivered to an ultimate purchaser or first placed into service. The warranty period is two years.
- (b) Subject to certain conditions and exclusions as stated below, the warranty on emissions related parts is as follows:
 - (1) Any warranted part that is not scheduled for replacement as required maintenance in your owner's manual is warranted for the warranty period stated above. If the part fails during the period of warranty coverage, the part will be repaired or replaced by FUJI according to subsection (4) below. Any such part repaired or replaced under warranty will be warranted for the remainder of the period.
 - (2) Any warranted part that is scheduled only for regular inspection in your owner's manual is warranted for the warranty period stated above. Any such part repaired or replaced under warranty will be warranted for the remaining warranty period.
 - (3) Any warranted part that is scheduled for replacement as required maintenance in your owner's manual is warranted for the period of time before the first scheduled replacement date for that part. If the part fails before the first scheduled replacement, the part will be repaired or replaced by FUJI according to subsection (4) below. Any such part repaired or replaced under warranty will be warranted for the remainder of the period prior to the first scheduled replacement point for the part.
 - (4) Repair or replacement of any warranted part under the warranty provisions herein must be performed at a warranty station at no charge to the owner.
 - (5) Notwithstanding the provisions herein, warranty services or repair will be provided at all of our distribution centers that are franchised to service the subject engines.
 - (6) The owner must not be charged for diagnostic labor that leads to the determination that a warranted part is in fact defective, provided that such diagnostic work is performed at a warranty station.
 - (7) FUJI is liable for damages to other engine components proximately caused by a failure under warranty of any warranted part.
 - (8) Throughout the engine warranty period stated above, FUJI will maintain a supply of warranted parts sufficient to meet the expected demand for such parts.
 - (9) Any replacement part may be used in the performance of any warranty maintenance or repairs and must be provided without charge to the owner. Such use will not reduce the warranty obligations of FUJI.
 - (10) Add-on or modified parts that are not exempted by the Air Resources Board may not be used. The use of any non-exempted add-on or modified parts by the ultimate purchaser will be grounds for disallowing a warranty claims. FUJI will not be liable to warrant failures of warranted parts caused by the use of a non-exempted add-on or modified part.

(c) WARRANTED PARTS:

The repair or replacement of any warranted part otherwise eligible for warranty coverage may be excluded from such warranty coverage if FUJI demonstrates that the engine has been abused, neglected, or improperly maintained, and that such abuse, neglect, or improper maintenance was the direct cause of the need for repair or replacement of the part. That notwithstanding, any adjustment of a component that has a factory installed, and properly operating, adjustment limiting device is still eligible for warranty coverage. The following emissions warranty parts list are covered.

- (1) Fuel Metering System
 - (A) Carburetor and internal parts (and/or pressure regulator or fuel injection system).
 - (B) Air/fuel ratio feedback and control system, if applicable.
 - (C) Cold start enrichment system, if applicable.
 - (D) Regulator assy (gaseous fuel, if applicable)
- (2) Air Induction System
 - (A) Intake manifold, if applicable
 - (B) Air filter.
- (3) Ignition System
 - (A) Spark plugs.
 - (B) Magneto or electronic ignition system.
 - (C) Spark advance/retard system, if applicable.
- (4) Exhaust manifold, if applicable
- (5) Evaporation System
 - (A) Fuel line
 - (B) Fuel line fittings

FOREWORD

Thank you very much for purchasing a **ROBIN PUMP**.

This manual covers operation and maintenance of **ROBIN PUMP**.

All information in this publication is based on the latest product information available at the time of approval for printing. Please read this manual carefully before operating.

Please take a moment to familiarize yourself with the proper operation and maintenance procedures in order to maximize the safe and efficient use of this product.

Keep this owner's manual at hand, so that you can refer to it at any time.

Due to constant efforts to improve our products, certain procedures and specifications are subjected to change without notice.

When ordering spare parts, always give us the **MODEL, PRODUCTION NUMBER** and **SERIAL NUMBER** of your pump.

Please fill in the following blanks after checking the production number on your pump.

(Location of label is different depending on the pump specification.)

PROD No.	SER No.

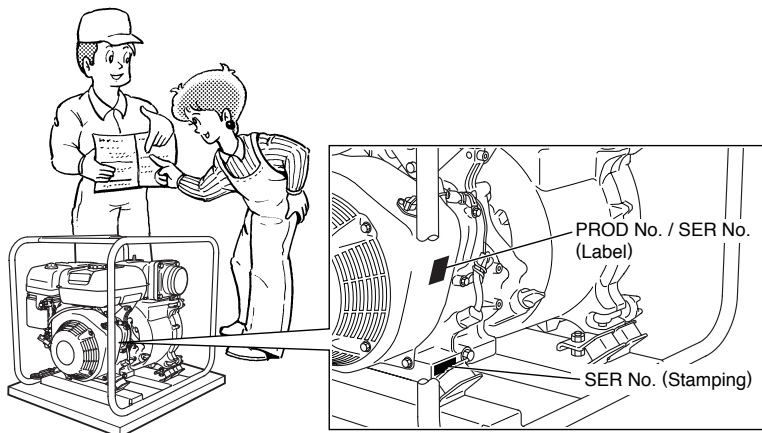

CONTENTS

	Page
1. SAFETY PRECAUTIONS	2
2. COMPONENTS	4
3. PRE-OPERATION FOR STARTING	5
4. OPERATING YOUR PUMP	6
5. MAINTENANCE	6
6. PREPARATIONS FOR STORAGE	9
7. OIL SENSOR INSTRUCTIONS	9
8. SPARK ARRESTER (OPTIONAL)	9
9. EASY TROUBLESHOOTING	10
10. SPECIFICATIONS	11

NOTE Please refer to the illustrations on the back page of the front cover or back cover for Fig. **1** to **8** indicated in the sentence.

1. SAFETY PRECAUTIONS

Please make sure you review each precaution carefully.
Pay special attention to statement preceded by the following words.

⚠ WARNING “WARNING” indicates a strong possibility of severe personal injury or loss of life if instructions are not followed.

⚠ CAUTION “CAUTION” indicates a possibility of personal injury or equipment damage if instructions are not followed.

⚠ WARNING : EXHAUST PRECAUTIONS

- Never inhale exhaust gasses.
They contain carbon monoxide, a colorless, odorless and extremely dangerous gas which can cause unconsciousness or death.
- Never operate the pump indoors or in a poorly ventilated area, such as tunnel, cave, etc.
- Exercise extreme care when operating the pump near people or animals.
- Keep the exhaust pipe free of foreign objects.

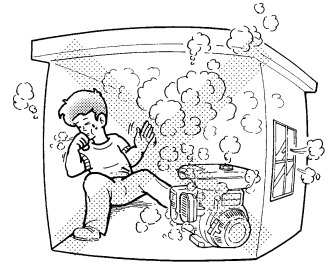

⚠ WARNING : REFUELING PRECAUTIONS

- Gasoline is extremely flammable and its vapors can explode if ignited.
- Do not refuel indoors or in a poorly ventilated area.
- Be sure to stop the pump prior to refueling.
- Do not remove fuel tank cap nor fill fuel tank while engine is hot or running.
Allow engine to cool at least 2 minutes before refueling.
- Do not overfill the fuel tank.
- If fuel is spilt, wipe it away carefully and wait until the fuel has dried before starting the engine.
- After refueling, make sure that the fuel cap is secured to prevent spillage.



⚠ WARNING : FIRE PREVENTION

- Do not operate the pump while smoking or near an open flame.
- Do not use around dry brush, twigs, cloth rags, or other flammable materials.
- Keep cooling air intake (recoil starter area) and muffler side of the engine at least 1 meter (3 feet) away from buildings, obstructions and other burnable objects.
- Keep the pump away from flammables and other hazardous materials (trash, rags, lubricants, explosives).



⚠ WARNING : OTHER SAFETY PRECAUTIONS

- Be careful of hot parts.
The muffler and other engine parts become very hot while the pump is running or just after it has stopped. Operate the pump in a safe area and keep children away from the running pump.
- Do not use diaphragm pump for the mixture of water and oil.

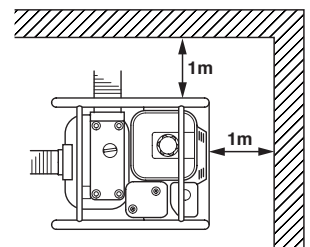

Do not touch the spark plug and ignition cable when starting and operating the engine.

Operate the pump on a stable, level surface.

If the engine is tilted, fuel spillage may result.

NOTE

Operating the pump at a steep incline may cause seizure due to improper lubrication even with a maximum oil level.

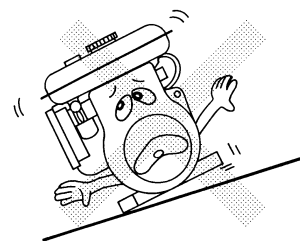

Do not transport the pump with fuel in tank or with fuel strainer cock open.

Keep the unit dry (do not operate it in rainy conditions).

⚠ CAUTION : PRE-OPERATION CHECKS

Carefully check fuel hoses and joints for looseness and fuel leakage. Leaked fuel creates a potentially dangerous situation.

Check bolts and nuts for looseness. A loose bolt or nut may cause serious engine trouble.

Check the engine oil and refill if necessary.

Check the fuel level and refill if necessary. Take care not to overfill the tank.







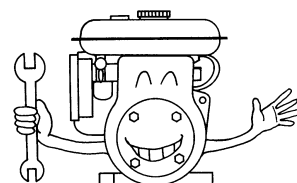





Keep cylinder fins and recoil starter free of dirt, grass and other debris.

Wear snug fitting working clothes when operating the engine.

Loose aprons, towels, belt, etc., may be caught in the engine or drive train, causing a dangerous situation.



SYMBOLS

	Read the owner's manual.		
	Stay clear of the hot surface.		
	Exhaust gas is poisonous. Do not operate in an unventilated area.		
	Stop the engine before refueling.		
	Fire, open flame and smoking prohibited.		
	On (Run)		Plus ; Positive polarity
	Off (Stop)		Battery
	Engine oil		Engine start (Electric start)
	Add oil		

2. COMPONENTS

(See Fig. 1)

NOTE Please refer to the illustrations on the back page of the front cover or back cover for Fig. 1 to 8 indicated in the sentence.

- | | | |
|------------------------------|-------------------------------|---|
| ① Plug (drain) | ⑪ Delivery | ⑳ Hose band |
| ② Casing | ⑫ Knob | ㉑ Tools |
| ③ Suction | ⑬ Oil filler (with oil guage) | ㉒ Instruction for use
(This publication) |
| ④ Plug (priming) | ⑭ Stop switch | |
| ⑤ Muffler | ⑮ Recoil Starter | |
| ⑥ Air cleaner | ⑯ Recoil Starter handle | |
| ⑦ Spark plug | ⑰ Fuel cock | |
| ⑧ Drain plug (at two places) | ⑱ Chocke knob | |
| ⑨ Casing cover | ⑲ Speed control lever | |
| ⑩ Fuel tank | ⑳ Strainer | |

3. PRE-OPERATION FOR STARTING

(See Fig. ②)

1. CONNECT SUCTION HOSE

(See Fig. ②-①)

Use a reinforced-wall or wire braided hose to prevent suction collapse.

Since the pump self-priming time is directly proportional to hose length, a short hose is recommended.

CAUTION

Always use a strainer with the suction hose. Gravel or debris sucked into the pump will cause serious damage to the impeller and the pump casting.

2. CONNECT DELIVERY HOSE

(See Fig. ②-②)

When using a fabric hose, always use a hose band to prevent the hose from disconnecting under high pressure.

3. CHECK ENGINE OIL (See Fig. ②-④)

Before checking or refilling engine oil, be sure the engine is located on stable, level surface and stopped.

Do not screw the oil gauge into the oil filler neck to check oil level. If the oil level is low, refill to the upper level with the following recommended oil.

Use 4-stroke automotive detergent oil of API service class SE or higher grade (SG, SH or SJ is recommended).

Select the viscosity based on the air temperature at the time of operation as shown in the table. (See Fig. ②-③)

Oil capacity (Upper level) : L(U.S.gal)

PKV401T 1.2 (0.32)

Explanation of Fig. ②-④

- ① Oil Gauge
- ② Upper Level
- ③ Lower Level

4. CHECK FUEL

(See Fig. ②-⑤)

WARNING

Do not refuel while smoking, near an open flame or other such potential fire hazards. Otherwise fire accident may occur.

NOTE

THIS ENGINE IS CERTIFIED TO OPERATE ON AUTOMOTIVE UNLEADED GASOLINE.

Stop the engine and open the cap.

Use automotive unleaded gasoline only.

Fuel Tank Capacity

Refer to "10. SPECIFICATIONS" Page 11 for fuel tank capacity

Close the fuel cock before filling the fuel tank.

Do not fill above the top of the fuel filter screen (marked ②), or the fuel may overflow when it heats up later and expands.

When filling the fuel tank, always use the fuel filter screen.

Wipe off any spilled fuel before starting the engine. (See Fig. ②-⑥)

5. CHECK PRIMING WATER

(See Fig. ②-⑦)

It is recommended that the water chamber of pump casing should be primed with full of water before operating.

WARNING

Never attempt to operate the pump without priming water or the pump will overheat. Extended dry operation will destroy the mechanical seal.

If the unit has been operated dry, stop the engine immediately and allow the pump to cool before adding priming water.

4. OPERATING YOUR PUMP

1. STARTING (See Fig. ③)

- (1) Open the fuel cock. (See Fig.③-①)
 - ① OPEN
 - ② CLOSE
- (2) Turn the STOP SWITCH to the position “ I ” (ON). (See Fig.③-②)
- (3) Set the speed control lever 1/3 to 1/2 of the way towards the high speed position. (See Fig.③-③)
 - ① Speed control lever
 - ② Starting position
 - ③ High speed
 - ④ Low speed
- (4) Close the choke knob. (See Fig.③-④)

① CLOSE

If the engine is cold or the ambient temperature is low, close the choke knob fully.

If the engine is warm or the ambient temperature is high, open the choke knob half-way, or keep it fully open.

- (5) Pull the starter handle slowly until resistance is felt. This is the “compression” point. Return the handle to its original position and pull swiftly. Do not pull out the rope all the way. After starting the engine, allow the starter handle to return to its original position while still holding the handle. (See Fig.③-⑤)

① Recoil starter handle

② Pull rapidly

- (6) After starting the engine, gradually open choke by turning the choke knob and finally keep it fully opened. Do not fully open the choke knob immediately when the engine is cold or the ambient temperature is low, because the engine may stop. (See Fig.③-⑥)

① OPEN

2. RUNNING (See Fig. ④)

- ① High speed position
- ② Low speed position

- (1) After the engine starts, set the speed control lever at the low speed position (L) and warm it up without load for a few minutes. (See Fig.④-①)
- (2) Gradually move the speed control lever toward the high speed position (H) and set it at the required engine speed. (See Fig.④-②)

Whenever high speed operation is not required, slow the engine down (idle) by moving the speed control lever to save fuel and extend engine life.

3. STOPPING (See Fig. ⑤)

- (1) Set the speed control lever at the low speed position and allow the engine to run at low speed for 2 or 3 minutes before stopping. (See Fig.⑤-①)

① Low speed position

- (2) Turn the STOP SWITCH counterclockwise to the position “ ” (OFF). (See Fig.⑤-②)

- ① ON
- ② OFF

- (3) Close the fuel cock. (See Fig.⑤-③)

- ① OPEN
- ② CLOSE

- (4) Pull the starter handle slowly and return the handle to its original position when resistance is felt. This operation is necessary to prevent outside moist air from intruding into the combustion chamber. (See Fig.⑤-④)

① Recoil starter handle

STOPPING ENGINE WITH THE FUEL COCK

Close the fuel cock and wait for a while until the engine stops. Avoid to let the fuel remain in the carburator over long periods, or the passages of the carburator may become clogged with impurities, and malfunctions may result.

5. MAINTENANCE

(See Fig. ⑥)

MAINTENANCE, REPLACEMENT, OR REPAIR OF THE EMISSION CONTROL DEVICES AND SYSTEMS MAY BE PERFORMED BY ANY NONROAD ENGINE REPAIR ESTABLISHMENT OR INDIVIDUAL.

1. DAILY INSPECTION

Before running the engine, check the following service items.

- ① Loose or broken bolts and nuts
- ② Clean air cleaner element
- ③ Enough clean engine oil
- ④ Leakage of gasoline and engine oil
- ⑤ Enough gasoline
- ⑥ Safe surroundings
- ⑦ Check the priming water
- ⑧ Excessive vibration, noise

2. PERIODIC INSPECTION

Periodic maintenance is vital to the safe and efficient operation of your pump.

Check the table below for periodic maintenance intervals.

IT IS ALSO NECESSARY FOR THE USER OF THIS PUMP TO CONDUCT THE MAINTENANCE AND ADJUSTMENTS ON THE EMISSION-RELATED PARTS LISTED BELOW TO KEEP THE EMISSION CONTROL SYSTEM EFFECTIVE.

The emission control system consists of the following parts :

- (1) Carburetor and internal parts
- (2) Cold start enrichment system, if applicable
- (3) Intake manifold, if applicable
- (4) Air cleaner elements
- (5) Spark plug
- (6) Magneto or electronic ignition system
- (7) Spark advance/ retard system, if applicable
- (8) Exhaust manifold, if applicable.
- (9) Hoses, belts, connectors, and assemblies

The maintenance schedule indicated in the following table is based on the normal engine operation.

Should the engine be operated in extremely dusty condition or in heavier loading condition, the maintenance intervals must be shortened depending on the contamination of oil, clogging of filter elements, wear of parts, and so on.

CAUTION

Replace rubber pipes for fuel passage every two years. If fuel leakage is found, replace the pipe immediately.

Periodic Maintenance Schedule table

MS2234

Maintenance Items	Every 8 hours (Daily)	Every 50 hours (Weekly)	Every 200 hours (Monthly)	Every 500 hours	Every 1000 hours
Clean pump set and check bolt and nuts	● (Daily)				
Check and refill engine oil	● (Refill daily up to upper level)				
Change engine oil (*Note 1)	● (Initial 20 hours)	● (Every 100 hours)			
Clean spark plug		●			
Clean air cleaner		●			
Clean spark arrester (Optional part)		● (Every 100 hours)			
Replace air cleaner element			●		
Clean fuel strainer			●		
Clean and adjust spark plug and electrodes			●		
Replace spark plug				●	
Remove carbon from cylinder head (*Note 2)				●	
Check and adjust valve clearance (*Note 2)				●	
Clean and adjust carburetor (*Note 2)				●	
Replace fuel lines					● (Yearly)
Overhaul engine if necessary (*Note 2)					●

*Note 1: Initial oil change should be performed after first twenty (20) hours of operation. Thereafter change oil every hundred (100) hours. Before changing oil, check for a suitable way to dispose of old oil. Do not pour it down into sewage drains, onto garden soil or into open streams. Your local zoning or environmental regulations will give you more detailed instructions on proper disposal.

*Note 2: As to the procedures for these items, please refer to the SERVICE MANUAL or consult your nearest service dealer.

3. INSPECTING THE SPARK PLUG

(See Fig. 7-①)

- (1) Clean off carbon deposits on the spark plug electrode using a plug cleaner or wire brush.
- (2) Check electrode gap. The gap should be 0.03 in. (0.7 mm to 0.8 mm). Adjust the gap, if necessary, by carefully bending the side electrode.

Recommended Spark Plug : NGK BPR6ES

4. ENGINE OIL CHANGE (See Fig. 7-②,③)

Initial oil change : After 20 hours of operation
Thereafter : Every 100 hours of operation

- (1) When changing oil, stop the engine and loosen the drain plug. Drain the used oil while the engine is warm. Warm oil drains quickly and completely.

⚠ CAUTION

To prevent injury, pay attention to the hot oil. Make sure the fuel cap is tightly secured to avoid spillage.

- (2) Re-install the drain plug before refilling oil.

Oil capacity (Upper level) : L(U.S.gal)
PKV401T 1.2 (0.32)

- (3) Refer to page 5 for the recommended oil.

- Always use the best grade and clean oil. Contaminated oil, poor quality oil and shortage of oil cause damage to engine or shorten the engine life.

5. CLEANING FUEL STRAINER

(See Fig. 7-④)

⚠ WARNING Flame Prohibited

- (1) Drain the fuel from the tank.
- (2) Close the fuel cock and remove the fuel strainer.
- (3) After removing dirt and water, wash the fuel strainer with kerosene or gasoline.
- (4) Reinstall securely to prevent leakage.

6. CLEANING AIR CLEANER

(See Fig. 7-⑤)

A dirty air cleaner element will cause starting difficulty, power loss, engine malfunctions, and shorten engine life extremely. Always keep the air cleaner element clean.

⚠ WARNING Flame Prohibited

Air cleaner paper element and urethane foam can be take out after removing knob and air cleaner cover.

When installing, set the paper element and urethane foam on the air cleaner base.

Be sure to check the grommet is in position, and then install the cover with knob tightened securely.

(See Fig. 7-⑤)

- Urethane Foam cleaning (See Fig. 7-⑤-③)
Wash and clean the urethane foam in kerosene. Saturate in a mixture of 3 parts kerosene and 1 part engine oil, and then squeeze to remove excess oil. Clean urethane form every 50 hours.
- Paper element (See Fig. 7-⑤-④)
Clean by tapping gently to remove dirt and blow off dust. Never use oil. Clean paper element every 50 hours of operation, and replace element every 200 hours.

Clean and replace air cleaner elements more often when operating in dusty environments.

7. FUEL HOSE REPLACEMENT (See Fig. 7-⑥)

⚠ WARNING

Take extreme caution when replacing fuel hose ; gasoline is extremely flammable.

Replace the fuel hose every 1,000 hours or every year. If fuel leaks from fuel hose, replace the fuel hose immediately.

8. CHECKING BOLTS, NUTS AND SCREWS

- Retighten loose bolts and nuts.
- Check for fuel and oil leaks.
- Replace damaged parts with new ones.

9. CLEANING PUMP INSIDE

- Turn the knob counterclockwise and open the casing cover holder.
- Pull the casing toward you, and then remove the casing and the inner casing.
- Clean the inside of pump casing and casing cover with clean water.

6. PREPARATIONS FOR STORAGE

1. WATER (See Fig. 8-1)

Drain all water from the drain plug.

⚠ CAUTION

When retightening drain plug, be sure to clean the drain plug and the thread of casing. Otherwise, the thread may be damaged.

2. DISCONNECT THE DELIVERY HOSE

Tilt the pump and drain all water from delivery hole. Severe damage to pump may result if water freezes in the pumping chamber.

3. DISCHARGE FUEL (See Fig. 8-2)

⚠ WARNING Flame Prohibited

If you do not use the engine more than 1 month, discharge fuel to prevent gum in the fuel system and carburetor parts.

Remove the strainer cup, place the strainer over a container and open the strainer cock to discharge fuel from the fuel tank.

Remove the drain screw of the carburetor float chamber and discharge fuel.

4. ENGINE OIL (See Fig. 8-3)

Change the engine oil with fresh oil.

Remove the spark plug, pour about 5 cc of engine oil into the cylinder, slowly pull the starter handle of the recoil starter 2 or 3 times, and reinstall the spark plug.

5. CLEAN AND STORE

Slowly pull the recoil starter handle until resistance is felt and leave it in that position.

Clean the pump thoroughly with an oiled cloth, put the cover on, and store the pump indoors in a well ventilated, low humidity area.

7. OIL SENSOR INSTRUCTIONS

(OPTIONAL)

1. FUNCTION OF OIL SENSOR

The engine will stop automatically when the oil level falls below the safety limit. The engine cannot be started unless the level is raised above the prescribed limit. (See Fig. 2-4)

2. RESTARTING (See Fig. 8-4)

① Oil sensor

- (1) Fill the crankcase with oil up to the proper level.
- (2) As for restarting and operating the engine, refer to section "4. OPERATING YOUR PUMP" on page 6.

Check the wire connector from the engine. It must be connected securely to the wire from oil sensor.

When selecting the engine oil, refer to page 5 for the recommended oil.

8. SPARK ARRESTER (OPTIONAL)

1. SPARK ARRESTER

In a dry or wooded area, it is recommendable to use the product with a spark arrester. Some areas require the use of a spark arrester. Please check your local laws and regulations before operating your product.

The spark arrester must be cleaned regularly to keep it functioning as designed. A clogged spark arrester:

- Prevents the flow of exhaust gas
- Reduces engine output
- Increases fuel consumption
- Makes starting difficult

If the engine has been running, the muffler and the spark arrester will be very hot. Allow the muffler to cool before cleaning the spark arrester.

How to remove the spark arrester

1. Remove the flange bolts from the muffler cover and remove the muffler cover.
2. Remove the special screw from the spark arrester and remove the spark arrester from the muffler.

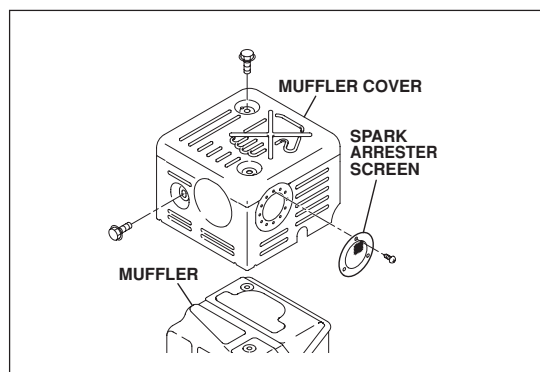

Clean the spark arrester screen

Use a brush to remove carbon deposits from the spark arrester screen. Be careful to avoid damaging the screen. The spark arrester must be free of breaks and holes. Replace the spark arrester if it is damaged.

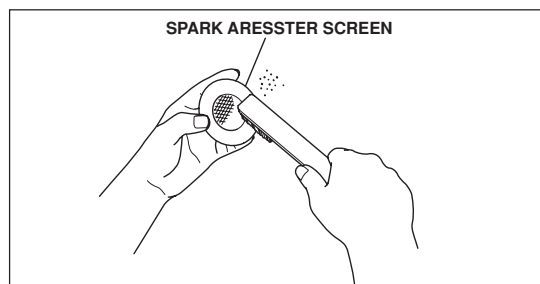

Install the spark arrester, and muffler protector in the reverse order of disassembly.

9. EASY TROUBLESHOOTING

1. PUMP DOES NOT RUN .

- Engine dose not start.
(See 9.-4 “4. WHEN ENGINE DOES NOT START”)
- Sticking of impeller
(Disassemble and clean.)

2. PUMPING VOLUME IS SMALL.

- Sucking air at suction side.
(Check piping at suction side.)
- Drop off engine output
(Consult your nearest dealer.)
- Breakage of mechanical seal.
(Consult your nearest dealer.)
- High suction lift (Lower.)
- Suction hose is too long or thin.
(Use a thick hose in minimum length.)
- Leak of water from water passage.
(Stop leaking.)
- Clogging of foreign substance in impeller.
(Disassemble and clean.)
- Wear of impeller.
- Looseness of suction chamber. (Retighten)
- Strainer is clogged. (Clean.)
- Engine speed is too low.
(Consult your nearest dealer.)

3. PUMP DOES NOT SELFPRIME.

- Suction of air at suction side.
(Check piping at suction side.)
- Insufficient priming water inside pump casing
(Prime fully.)
- Imperfect tightening of drain plug.
(Tighten the plugs completely.)
- Engine speed is too low.
(Consult your nearest dealer.)
- Sucking air from mechanical seal.
(Consult your nearest dealer.)

4. WHEN ENGINE DOES NOT START :

Perform the following checks before you take the pump to your Robin dealer. If you still have trouble after completing the checks, take the pump to your nearest Robin dealer.

(1) Is there a strong spark across the electrode ?

- Is the stop switch at position “ I ” (ON)?
- Remove and inspect the spark plug.
If the electrode is fouled, clean or replace it with new one.
- Remove the spark plug and connect it to the plug cap.
Pull the starter handle while grounding spark plug against engine body. Try with a new spark plug if the spark is weak or there is no spark.
The ignition system is faulty if there is no spark with a new spark plug.

WARNING

- **Wipe out spilled fuel carefully before testing. Place spark plug as far away from spark plug hole as possible.**
- **Do not hold spark plug by hand while pulling recoil starter.**

NOTE

The engine with oil sensor will stop automatically when the oil level falls below the prescribed limit. Unless the oil level is raised above the prescribed limit, the engine will stop immediately after starting.

(2) Is there enough compression?

Pull the starter handle slowly and check if resistance is felt. If little force is required to pull the starter handle, check if the spark plug is tightened firmly. If the spark plug is loose, tighten it.

(3) Is the spark plug wet with gasoline?

- Is the fuel cock opened?
- Choke (close choke knob) and pull the starter handle five or six times. Remove the plug and check if its electrode is wet. If the electrode is wet, fuel is well supplied to your engine.
- When the electrode is dry, check where the fuel stops.
(Check the fuel intake of the carburetor and fuel strainer intake.)
- In case the engine does not start with well supplied fuel, try using fresh fuel.

10. SPECIFICATIONS

MODEL		PKV401T
PUMP	Type	Self-priming, Trash pump
	Suction x Delivery Diameters mm(in.)	100 x 100 (4 x 4)
	Total Head m(ft)	27 (89)
	Maximum Delivery Volume Liter(U.S.gal) / min	1620 (428)
	Suction Head m(ft)	8 (26)
	Axle Seal Material (Mechanical Seal)	Silicon - carbide
ENGINE	Model	EH41D
	Type	Air-cooled,4-cycle,Single cylinder, Horizontal Shaft,Gasoline Engine
	Lubricant	4-Stroke automotive detergent oil - SAE;#20,#30 or 10W-30 API service class;SE or higher (SG,SH or SJ is recommended)
	Oil Capacity Liter (U.S.gal)	1.2 (0.32)
	Fuel	Automotive unleaded gasoline
	Fuel Tank Capacity Liter (U.S.gal)	7.0 (1.85)
	Spark plug	NGK BPR6ES
	Starting system	Recoil starter
Dimensions (L x W x H) mm (in.)	745 x 535 x 625 (29.33 x 21.06 x 24.61)	
Dry Weight kg (lb)	79 (174.20)	
Standard accessories	Engine tool kit (1 set), Strainer (1 pc.), Hose band (3 pcs.)	
Valve Clearance (Intake and Exhaust)	0.1±0.03 mm (0.0039±0.0012 in.) Note : Adjust the valve clearance while the engine is cold.	
Emissions Durability Period (California only)	500 hours	

ISSUE EMD-PU2255

FUJI HEAVY INDUSTRIES LTD.
INDUSTRIAL PRODUCTS COMPANY

4-410 Asahi, Kitamoto-shi,
Saitama, 364-8511, Japan
Phone +81(48) 593-7798
Fax +81(48) 593-7946
Web site <http://www.fhi.co.jp/robin/>

PRINTED IN JAPAN
October 2006