

LCD Digital Colour TV

Operating Instructions

Setting Up

Watching TV

Additional Information

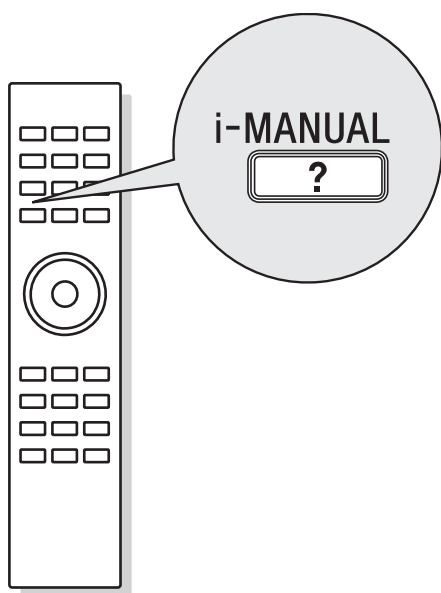

BRAVIA

Introduction

Thank you for choosing this Sony product. Before operating the TV, please read this manual thoroughly and retain it for future reference.



- The illustrations used in this manual are of the KDL-40EX500 unless otherwise state.
- In this manual, following models are described as HX700 models.
KDL-55/46/40HX700

Following models are described as EX500 models.
KDL-55/46/40/32EX500

Following models are described as EX400 models.
KDL-40/32EX400

Trademark information

DVB is a registered trademark of the DVB Project

HDMI, the HDMI logo and High-Definition Multimedia Interface are trademarks or registered trademarks of HDMI Licensing LLC.

DLNA and DLNA CERTIFIED are trademarks and/or service marks of Digital Living Network Alliance.

DivX® is a video file compression technology, developed by DivX, Inc. DivX, DivX Certified, and associated logos are trademarks of DivX, Inc. and are used under license.

ABOUT DIVX VIDEO: DivX® is a digital video format created by DivX, Inc. This is an official DivX Certified device that plays DivX video. Visit www.divx.com for more information and software tools to convert your files into DivX video.

ABOUT DIVX VIDEO-ON-DEMAND: This DivX Certified® device must be registered in order to play DivX Video-on-Demand (VOD) content. To generate the registration code, locate the DivX VOD section in the device setup menu. Go to vod.divx.com with this code to complete the registration process and learn more about DivX VOD.

Manufactured under license from Dolby Laboratories. Dolby and the double-D symbol are trademarks of Dolby Laboratories.

“BRAVIA” and BRAVIA are trademarks of Sony Corporation.

“XMB” and “xross media bar” are trademarks of Sony Corporation and Sony Computer Entertainment Inc.

Notes for Australia and New Zealand model

This product is ENERGY RATING qualified in the “Home” mode. ENERGY RATING is a program designed to promote energy efficient products and practices.

- When the TV is initially set up, it is designed to meet ENERGY RATING requirements while maintaining optimum picture quality.
- Changes to certain features, settings, and functionalities of this TV (e.g. TV Guide, Picture/Sound, Eco-Setting) can slightly change the power consumption.

Depending upon such changed settings (e.g. “Shop” mode), the power consumption may vary which possibly could exceed the stated energy rating.

To reset the TV to ENERGY RATING qualified settings, select “Home” mode from the initial set-up procedure in “Factory Settings” under the “Set-up” menu.

IMPORTANT INFORMATION

If a television is not positioned in a sufficiently stable location, it can be potentially hazardous due to falling. Many injuries, particularly to children, can be avoided by taking simple precautions such as:

- Using cabinets or stands recommended by the manufacturer of the television.
- Only using furniture that can safely support the television.
- Ensuring the television is not overhanging the edge of the supporting furniture.
- Not placing the television on tall furniture (for example, cupboards or bookcases) without anchoring both the furniture and the television to a suitable support.
- Not standing the televisions on cloth or other materials placed between the television and supporting furniture.
- Educating children about the dangers of climbing on furniture to reach the television or its controls.

Notice for customers in the South Africa

The Euro/South Africa converter plug should be fitted as follows.

- 1 Insert the power supply or CEE7 plug in to the converter plug.

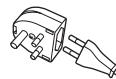

- 2 Use an appropriate screwdriver to attach the screw tightly without damaging the screw head.

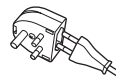

- 3 TEST: Grip the converter plug, and pull the VDE cord set/transformer to ensure it is fully secure, if not then increase the torque setting and further tighten. Re-test.

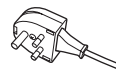

The converter plug is now ready for use.

HDMI[™]
HIGH-DEFINITION MULTIMEDIA INTERFACE

DOLBY
DIGITAL

DLNA
CERTIFIED

Table of Contents

Checking the accessories.....	3
Inserting batteries into the remote	3
Setting Up	
Attaching the Table-Top Stand.....	4
Connecting an antenna (aerial)/cable/VCR.....	5
Preventing the TV from toppling over	6
Bundling the cables	6
Performing the initial set-up.....	7
Detaching the Table-Top Stand from the TV.....	7
Watching TV	
To watch programmes.....	8
To utilise the TV's features	8
To use i-Manual.....	9
Additional Information	
Troubleshooting.....	10
Specifications	11
Installing the Accessories (Wall-Mount Bracket)	13
Safety Information	16
Precautions.....	17

- Operating instructions are built into your BRAVIA TV. Refer to “To use i-Manual” for operation (page 9).
- Before operating the TV, please read “Safety Information” (page 16). Retain this manual for future reference.

Checking the accessories

AC power cord (mains lead)

(for KDL-55/46EX500 and KDL-55/46HX700)

Cable holder (1)

(for HX700 models only)

Remote (1)

Size AAA batteries (R3 type) (2)

Table-Top Stand (1)*

Fixing screws for stand (M5 × 16) (4)

Assembling screws for stand

(M5 × 16) (4)

(only for KDL-40/32EX500 and KDL-40HX700)

Assembling screws for stand

(M4 × 10) (3)

(only for EX400 models)

* Disassembled except for 55-inch and 46-inch TVs. Refer to the supplied Table-Top Stand leaflet to assemble the stand.

Inserting batteries into the remote

RM-GD009/GD014 remote

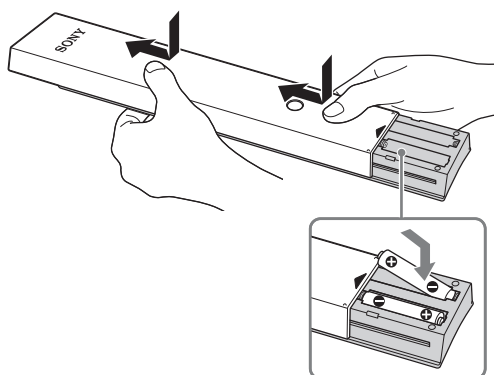

- 1 Remove the protection sheet.
- 2 Push and slide the cover upward.

RM-GD015 remote

Push and lift the cover to open.

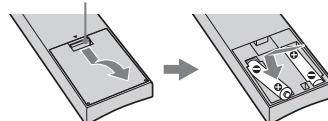

- See your remote for the model number.

Attaching the Table-Top Stand



- For best picture quality, do not expose the screen to direct illumination or sunlight.
- If the TV is brought directly from a cold to a warm location, or is placed in a very damp room, or is placed in a room in which heating has just been turned on, moisture may condense on the surface or inside the TV. Should this occur, turn off the TV and leave the TV off until the moisture evaporates, and then the TV can be used. If you notice moisture condensation between the glass panel and the LCD, turn on the TV and the condensation will evaporate after the TV has warmed up.

- 1 Refer to the supplied Table-Top Stand leaflet for proper attachment for some TV models.
- 2 Place the TV set on the Table-Top Stand.

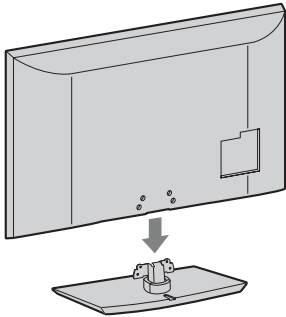

- 3 Fix the TV to the Table-Top Stand according to the arrow marks  that guide the screw holes using the supplied screws.

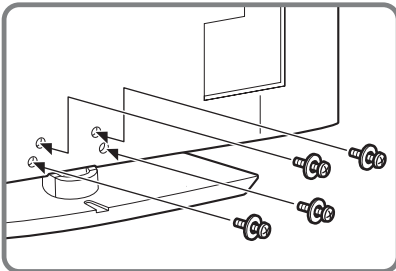

- If using an electric screwdriver, set the tightening torque at approximately 1.5 N·m {15 kgf·cm}.

Adjusting the viewing angle of the TV (HX700 models only)

This TV can be adjusted within the angles shown below.

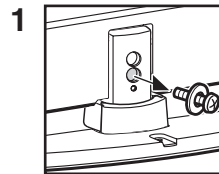
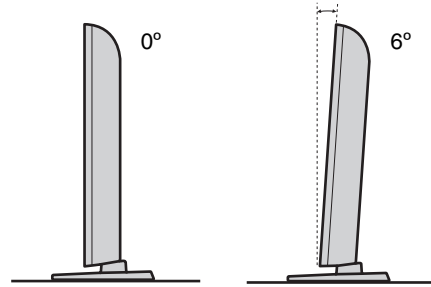

Remove screw as shown.

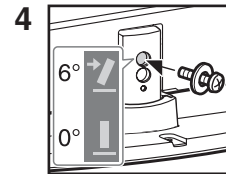

Install screw into the top screw hole of the Table-Top Stand.

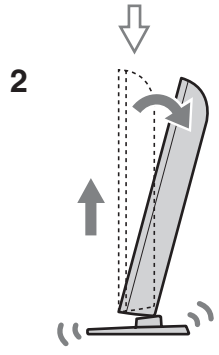

Lift up and tilt.

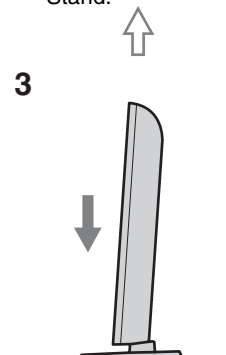

Slide in.



- To return to 0°, reverse the above procedure.

Connecting an antenna (aerial)/cable/VCR

Connecting an antenna (aerial)/cable

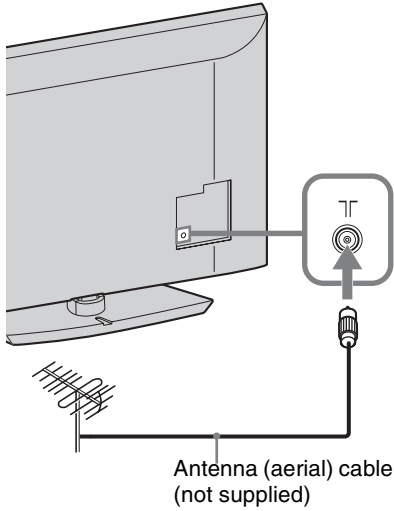

Connecting an antenna (aerial)/cable and VCR

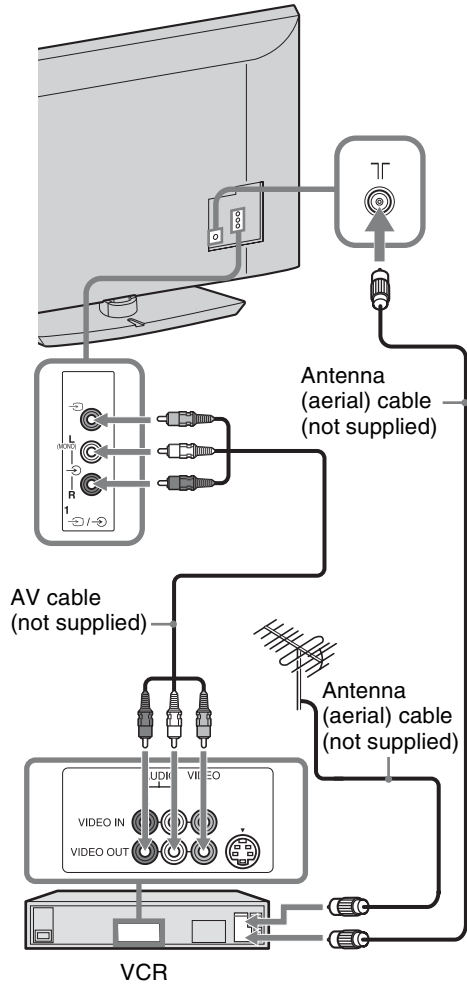

- When connecting an antenna (aerial) cable (not supplied), an adaptor (not supplied) may be required (Australian model and New Zealand model only).

Preventing the TV from toppling over

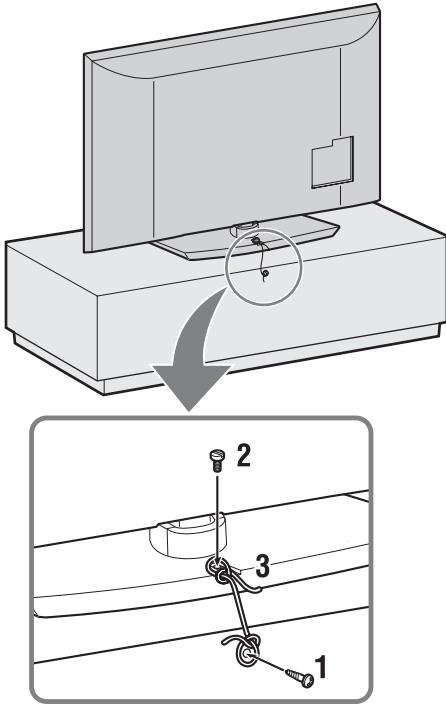

- 1** Install a wood screw (4 mm in diameter, not supplied) in the TV stand.
- 2** Install a machine screw (M4 × 16, not supplied) into the screw hole of the TV.
- 3** Tie the wood screw and the machine screw with a strong cord (not supplied).



- An optional Sony support belt kit is used to secure the TV. Contact your nearest Sony service centre to purchase a kit. Have your TV model name ready for reference.

Bundling the cables



- A cable holder is available for HX700 models. To bundle the cables, follow steps 2 to 4.

* For KDL-55/46EX500 and KDL-55/46HX700

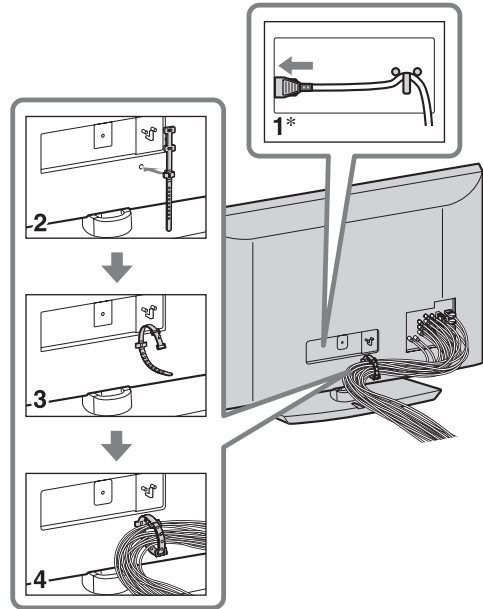

- Do not bundle the AC power cord (mains lead) together with other cables.

Performing the initial set-up

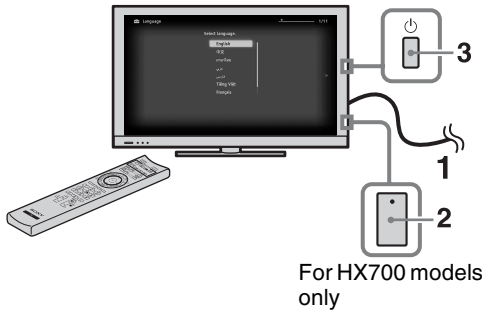

- 1 Connect the TV to your AC power outlet (mains socket).
- 2 For HX700 models, check the **ENERGY SAVING SWITCH** setting is on (●).
- 3 Press on the TV.
When you switch on the TV for the first time, the Language menu appears on the screen.

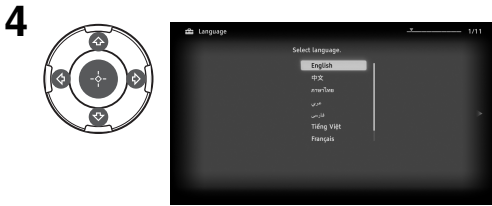

Follow the instructions on the screen.

Programme Sorting: Changes the order of analogue channels stored in the TV.

- 1 Press to select the channel you want to move to a new position, then press .
- 2 Press to select the new position for the channel, then press .



- You can also tune channels manually.

Detaching the Table-Top Stand from the TV



- Remove the screws guided by the arrow marks of the TV.
- Do not remove the Table-Top Stand for any reason other than to install corresponding accessories on the TV.

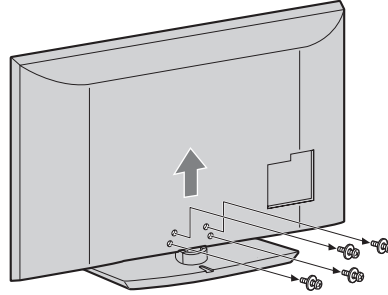

Watching TV

To watch programmes

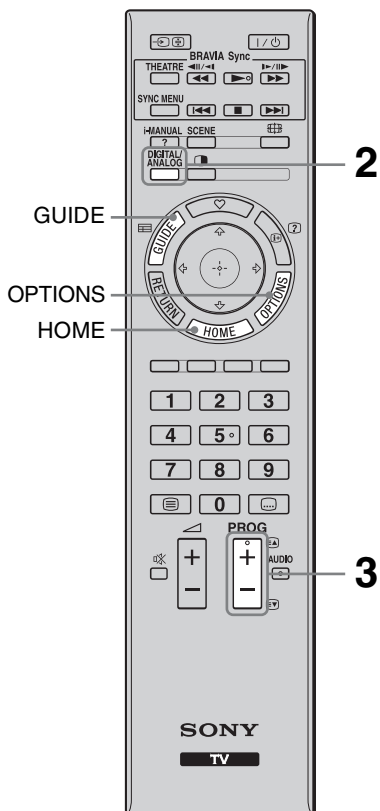

1 Turn on the TV.

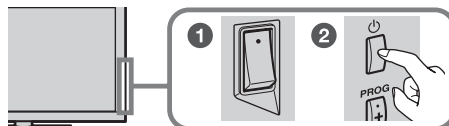

1 For HX700 models, switch **ENERGY SAVING SWITCH** on.

2 Press on the TV to turn on the TV.

2 Select a mode.



3 Select a TV channel.

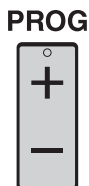

Using Digital Electronic Programme Guide (only available for EPG supported countries/regions)

Press **GUIDE** in digital mode to display the programme guide.



- The number 5, , **PROG +** and **AUDIO** buttons on the remote have a tactile dot. Use the tactile dots as a reference when operating the TV.

To utilise the TV's features

HOME button

Press to display various operation and setting screens.

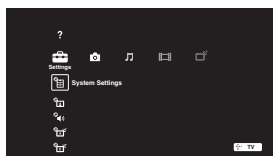

OPTIONS button

Press to display convenient functions based on the current input or content.

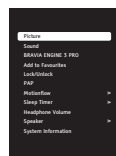

To use i-Manual

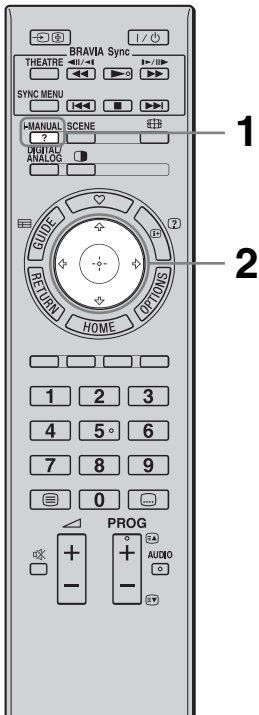

Operating instructions are built into your BRAVIA TV and can be displayed on the screen. You can browse your i-Manual anytime you need to find the varieties of convenient functions.



- This feature is unavailable when you select Arabic or Persian.

1 Press i-MANUAL.



2 Press $\leftarrow/\rightarrow/\uparrow/\downarrow/\oplus$ to select items.

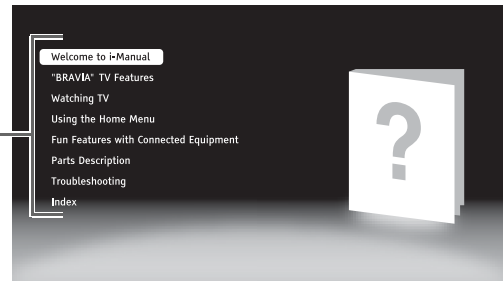
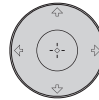

- **Welcome to i-Manual**
- **“BRAVIA” TV Features**
- **Watching TV**

Introduces convenient features such as EPG Guide, Favourites, etc.

■ **Using the HOME Menu**

Customise your TV settings, etc.

■ **Fun Features with Connected Equipment**

Introduces how to connect optional equipment.

■ **Parts Description**

■ **Troubleshooting**

Find solutions for your problem.

■ **Index**





- Images and illustrations may differ from what is displayed on the screen.

Troubleshooting

Check whether the  (standby) indicator is flashing in red.



When the (standby) indicator is flashing

The self-diagnosis function is activated.















- 1 Count how many times the  (standby) indicator flashes between each three second break.
For example, the indicator may flash three times, go off for three seconds, then flash again three times.
- 2 Press  on the TV to turn it off, disconnect the AC power cord (mains lead), and inform your dealer or Sony service centre of how the indicator flashes (number of flashes).

When the (standby) indicator is not flashing

- 1 Check the items in the tables below. (Also refer to “Troubleshooting” in the i-Manual.)
- 2 If the problem persists, have your TV serviced by qualified service personnel.

Condition	Explanation/Solution
Picture	
There is no picture (screen is dark) and no sound.	<ul style="list-style-type: none">• Check the antenna (aerial)/cable connection.• Connect the TV to the AC power (mains), and press  on the TV.• If the  (standby) indicator lights up in red, press .
Tiny black points and/or bright points appear on the screen.	<ul style="list-style-type: none">• The screen is composed of pixels. Tiny black points and/or bright points (pixels) on the screen do not indicate a malfunction.
General	
The TV's power cannot be turned on. (for HX700 models only)	<ul style="list-style-type: none">• Check if ENERGY SAVING SWITCH is on.
The TV turns off automatically (the TV enters standby mode).	<ul style="list-style-type: none">• Check if the “Sleep Timer” is activated, or confirm the “Duration” setting of “On Timer”.• Check if the “Idle TV Standby” is activated.
The remote does not function.	<ul style="list-style-type: none">• Replace the batteries.• Your TV may be in SYNC mode. Press SYNC MENU, select “TV Control” and then select “Home (Menu)” or “Options” to control the TV.
The “Parental Lock” password has been forgotten.	<ul style="list-style-type: none">• Enter 9999 for the PIN code. (PIN code 9999 is always accepted.)

Specifications

System	
Panel system	LCD (Liquid Crystal Display) Panel
TV system	Analogue: B/G, I, D/K, M Digital: DVB-T
Colour/video system	Analogue: PAL, PAL60 (only video input), SECAM, NTSC3.58, NTSC4.43 (only video input) Digital: MPEG-2 MP@ML/HL (Australian model), MPEG-2 MP@ML/HL, H.264/MPEG-4 AVC MP/HP@L4 (New Zealand and Singaporean model)
Channel coverage	Analogue: B/G: VHF: E2–E12/UHF: E21–E69/CATV: S01–S03, S1–S41 VHF: 0–12, 5A, 9A/UHF: 28–69/CATV: S01–S03, S1–S44 (Australia and Singapore only) VHF: 1–11/UHF: 21–69/CATV: S1–S41 (New Zealand and Singapore only) I: UHF: B21–B69/CATV: S01–S03, S1–S41 (Australia, New Zealand and South Africa only) D/K: VHF: C1–C12, R1–R12/UHF: C13–C57, R21–R60/CATV: S01–S03, S1–S41, Z1–Z39 (Australia, New Zealand and South Africa only) M: VHF: A2 to A13/ UHF: A14 to A79/ CATV: A-8 to A-2, A to W+4, W+6 to W+84 (South Africa only) Digital: VHF/UHF (Australia and Singapore only), UHF (New Zealand only)
Sound output	10 W + 10 W
Input/Output jacks	
Antenna (aerial)/cable	75 ohm external terminal for VHF/UHF
 1, 2	Video input (phono jack)
 1, 2	Audio input (phono jacks)
 1, 2 /  3	 COMPONENT IN Supported formats: 1080p, 1080i, 720p, 576p, 576i, 480p, 480i  3 Video input (phono jack)
HDMI IN1, 2, 3, 4	Video: 1080/24p, 1080p, 1080i, 720p, 576p, 576i, 480p, 480i Audio: Two channel linear PCM 32, 44.1 and 48 kHz, 16, 20 and 24 bits, Dolby Digital  Analogue audio input (minijack) (HDMI IN4 only) PC Input
 DIGITAL AUDIO OUT (OPTICAL)	Digital optical jack (Two channel linear PCM, Dolby Digital)
 (VAR/FIX)	Audio output (phono jacks)
 PC IN	PC Input (Mini D-sub 15-pin)  PC audio input (minijack)
	USB port
	Headphones jack
 LAN (for HX700 models only)	10BASE-T/100BASE-TX connector (Depending on the operating environment of the network, connection speed may differ. 10BASE-T/100BASE-TX communication rate and communication quality are not guaranteed for this TV.) * For LAN connections, use a Category 7 10BASE-T/100BASE-TX cable (not supplied).

Model name KDL-		55EX500	55HX700	46EX500	46HX700
Power and others					
Power requirements		110 V – 240 V AC, 50/60 Hz	110 V – 240 V AC, 50 Hz	110 V – 240 V AC, 50/60 Hz	110 V – 240 V AC, 50 Hz
Screen size (measured diagonally)		55 inches (Approx. 138.8 cm)		46 inches (Approx. 116.8cm)	
Display resolution		1,920 dots (horizontal) × 1,080 lines (vertical)			
Dimensions (Approx.) (w × h × d)	with Table-Top Stand	1,324 mm × 832 mm × 350 mm	1,363 mm × 862 mm × 400 mm	1,127 mm × 713 mm × 281 mm	1,154 mm × 741 mm × 370 mm
	without Table-Top Stand	1,324 mm × 795 mm × 105 mm	1,363 mm × 825 mm × 105 mm	1,127 mm × 676 mm × 101 mm	1,154 mm × 704 mm × 102 mm
Mass (Approx.)	with Table-Top Stand	30.7 kg	40.2 kg	21.6 kg	28.4 kg
	without Table-Top Stand	26.7 kg	34.4 kg	18.7 kg	24.3 kg
Supplied accessories		See “Checking the accessories” (page 3).			
Optional accessories	Wall-Mount Bracket	SU-WL500/WL50B			

Model name KDL-		40EX400	40EX500	40HX700	32EX400	32EX500
Power and others						
Power requirements		110 V – 240 V AC, 50/60 Hz		110 V – 240 V AC, 50 Hz	110 V – 240 V AC, 50/60 Hz	
Screen size (measured diagonally)		40 inches (Approx. 101.6cm)			32 inches (Approx. 80.1 cm)	
Display resolution		1,920 dots (horizontal) × 1,080 lines (vertical)				
Dimensions (Approx.) (w × h × d)	with Table-Top Stand	992 mm × 635 mm × 250 mm	992 mm × 636 mm × 260 mm	1,023 mm × 665 mm × 310 mm	800 mm × 532 mm × 220 mm	800 mm × 534 mm × 250 mm
	without Table-Top Stand	992 mm × 598 mm × 100 mm	992 mm × 599 mm × 99 mm	1,023 mm × 628 mm × 100 mm	800 mm × 497 mm × 97 mm	800 mm × 497 mm × 96 mm
Mass (Approx.)	with Table-Top Stand	15.9 kg	16.4 kg	22.4 kg	11.0 kg	11.9 kg
	without Table-Top Stand	13.9 kg	14.2 kg	19.2 kg	9.5 kg	9.9 kg
Supplied accessories		See “Checking the accessories” (page 3).				
Optional accessories	Wall-Mount Bracket	SU-WL500/WL50B				

Design and specifications are subject to change without notice.

Installing the Accessories (Wall-Mount Bracket)

To Customers:

For product protection and safety reasons, Sony strongly recommends that installing of your TV be performed by Sony dealers or licensed contractors. Do not attempt to install it yourself.

To Sony Dealers and Contractors:

Provide full attention to safety during the installation, periodic maintenance and examination of this product.

Your TV can be installed using the SU-WL500 or SU-WL50B Wall-Mount Bracket (sold separately).

- Refer to the Instructions supplied with the Wall-Mount Bracket to properly carry out the installation.
- Refer to “Detaching the Table-Top Stand from the TV” (page 7).



- Place the TV on the Table-Top Stand, when securing the Mounting Hook.

SU-WL500

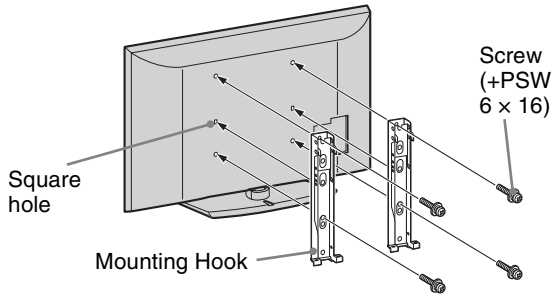

SU-WL50B

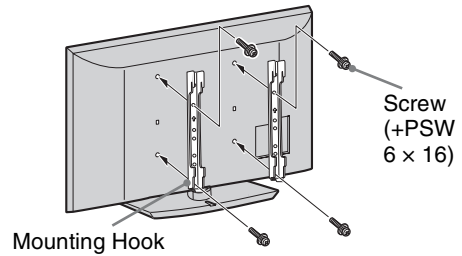

Sufficient expertise is required for installing this product, especially to determine the strength of the wall for withstanding the TV's weight. Be sure to entrust the attachment of this product to the wall to Sony dealers or licensed contractors and pay adequate attention to safety during the installation. Sony is not liable for any damage or injury caused by mishandling or improper installation.

TV installation dimensions table

SU-WL500

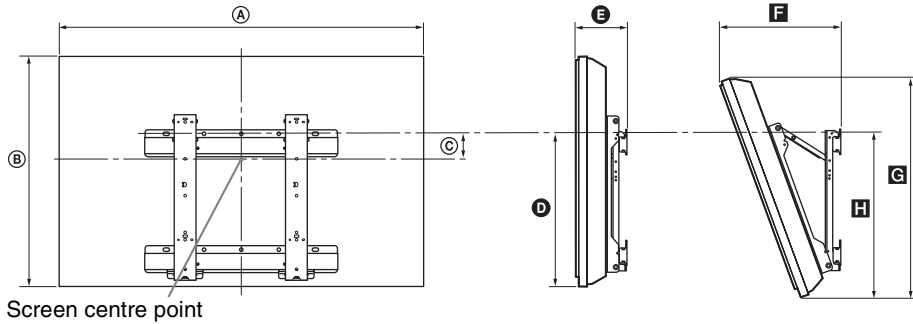

SU-WL50B

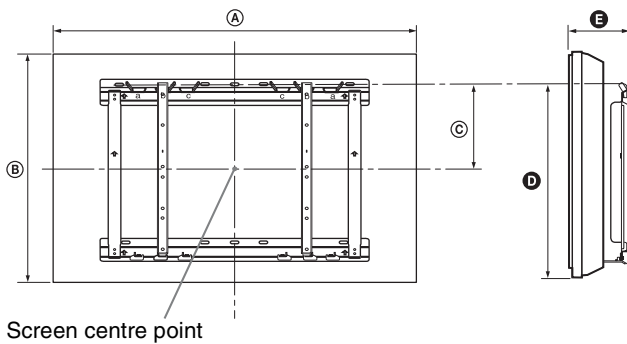

Unit: mm

Model Name KDL-	Display dimensions		Screen centre dimension		Length for each mounting angle						
					Angle (0°)				Angle (20°)		
	A	B	C		D		E		F	G	H
		SU-WL500	SU-WL50B	SU-WL500	SU-WL50B	SU-WL500	SU-WL50B	SU-WL500 only			
55EX500	1,324	795	25	78	428	481	165	166	413	752	466
55HX700	1,363	825	25	78	439	492	165	166	421	776	481
46EX500	1,127	676	84	137	426	478	161	162	369	640	463
46HX700	1,154	704	84	137	439	492	162	163	377	662	480
40EX400	992	598	122	175	425	478	160	161	341	567	463
40EX500	992	599	122	175	426	479	159	160	341	567	463
40HX700	1,023	628	122	175	439	492	160	160	349	591	479
32EX400	800	497	172	200	426	454	157	158	303	470	461
32EX500	800	497	172	200	426	454	156	157	303	470	461

Figures in the above table may differ slightly depending on the installation.

WARNING

The wall that the TV will be installed on should be capable of supporting a weight of at least four times that of the TV. Refer to “Specifications” (page 11) for its weight.

Screw and Hook locations diagram/table

Model Name	Screw location		Hook location	
	SU-WL500	SU-WL50B	SU-WL500	SU-WL50B
KDL-55HX700 / 55EX500	d, g	d, i	a	
KDL-46HX700 / 46EX500 KDL-40HX700 / 40EX500 / 40EX400			b	
KDL-32EX500 / 32EX400	e, g	e, h	c	

SU-WL500

Screw location

When installing the Mounting Hook on the TV.

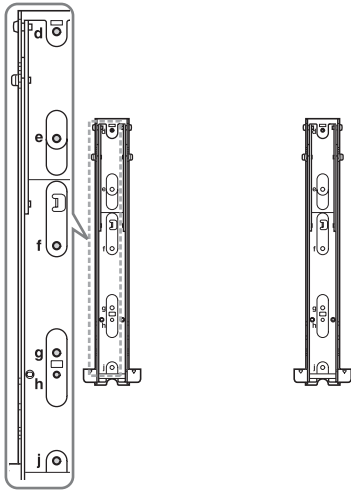

Hook location

When installing the TV onto the Base Bracket.

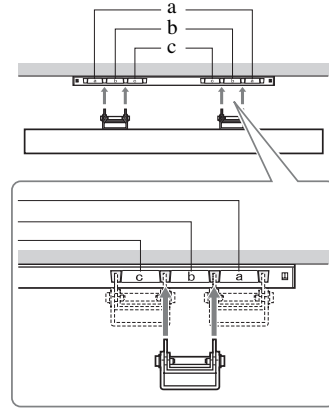

SU-WL50B

Screw location

When installing the Mounting Hook on the TV.

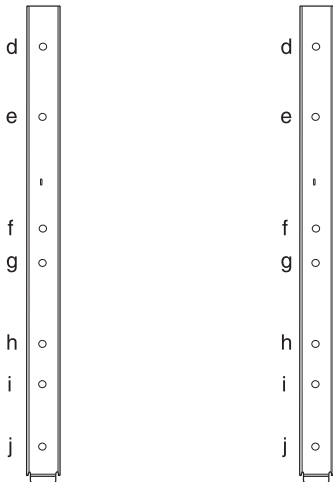

Hook location

When installing the TV onto the Base Bracket.

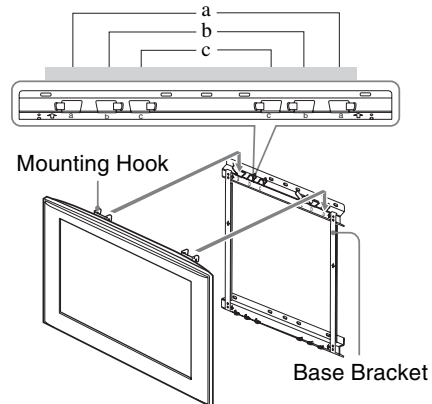

Safety Information

Installation/Set-up

Install and use the TV set in accordance with the instructions below in order to avoid any risk of fire, electrical shock or damage and/or injuries.

Installation

- The TV set should be installed near an easily accessible AC power outlet.
- Place the TV set on a stable, level surface to avoid it from falling down and cause personal injury or damage to the TV.
- Only qualified service personnel should carry out wall installations.
- For safety reasons, it is strongly recommended that you use Sony accessories, including:
 - Wall-mount bracket SU-WL500/WL50B
- Be sure to use the screws supplied with the Wall-mount bracket when attaching the mounting hooks to the TV set. The supplied screws are designed so that they are 8 mm to 12 mm in length when measured from the attaching surface of the mounting hook. The diameter and length of the screws differ depending on the Wall-mount bracket model. Use of screws other than those supplied may result in internal damage to the TV set or cause it to fall, etc.

8 mm - 12 mm

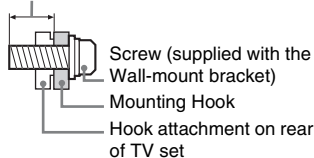

Transporting

- Before transporting the TV set, disconnect all cables.
- Two or three people are needed to transport a large TV set.
- When transporting the TV set by hand, hold it as shown on the right. Do not put stress on the LCD panel and the frame around the screen.
- When lifting or moving the TV set, hold it firmly from the bottom.
- When transporting the TV set, do not subject it to jolts or excessive vibration.
- When transporting the TV set for repairs or when moving, pack it using the original carton and packing material.

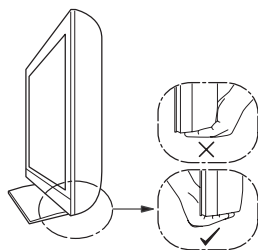

Ventilation

- Never cover the ventilation holes or insert anything in the cabinet.
- Leave space around the TV set as shown below.
- It is strongly recommended that you use a Sony wall-mount bracket in order to provide adequate air-circulation.

Installed on the wall

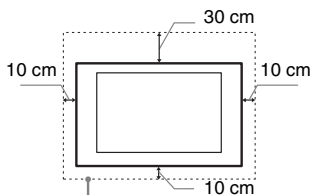

Leave at least this space around the set.

Installed with stand

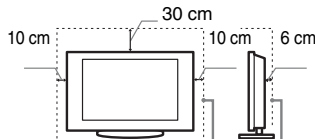

Leave at least this space around the set.

- To ensure proper ventilation and prevent the collection of dirt or dust:
 - Do not lay the TV set flat, install upside down, backwards, or sideways.
 - Do not place the TV set on a shelf, rug, bed or in a closet.
 - Do not cover the TV set with a cloth, such as curtains, or items such as newspapers, etc.
 - Do not install the TV set as shown below.

Air circulation is blocked.

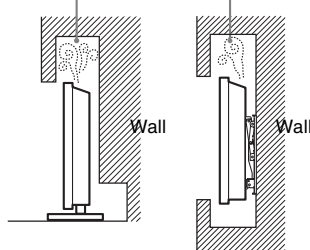

AC power cord

Handle the AC power cord and outlet as follows in order to avoid any risk of fire, electrical shock or damage and/or injuries:

- Use only Sony supplied AC power cords, not those of other brands.
- Insert the plug fully into the AC power outlet.
- Operate the TV set on a 110–240 V AC supply only.
- When wiring cables, be sure to unplug the AC power cord for your safety and take care not to catch your feet on the cables.
- Disconnect the AC power cord from the AC power outlet before working on or moving the TV set.
- Keep the AC power cord away from heat sources.
- Unplug the AC power plug and clean it regularly. If the plug is covered with dust and it picks up moisture, its insulation may deteriorate, which could result in a fire.

Notes

- Do not use the supplied AC power cord on any other equipment.
- Do not pinch, bend, or twist the AC power cord excessively. The core conductors may be exposed or broken.
- Do not modify the AC power cord.
- Do not put anything heavy on the AC power cord.
- Do not pull on the AC power cord itself when disconnecting the AC power cord.
- Do not connect too many appliances to the same AC power outlet.
- Do not use a poor fitting AC power outlet.

Prohibited Usage

Do not install/use the TV set in locations, environments or situations such as those listed below, or the TV set may malfunction and cause a fire, electrical shock, damage and/or injuries.

Location:

Outdoors (in direct sunlight), at the seashore, on a ship or other vessel, inside a vehicle, in medical institutions, unstable locations, near water, rain, moisture or smoke.

Environment:

Places that are hot, humid, or excessively dusty; where insects may enter; where it might be exposed to mechanical vibration, near flammable objects (candles, etc). The TV set shall not be exposed to dripping or splashing and no objects filled with liquids, such as vases, shall be placed on the TV.

Situation:

Do not use when your hands are wet, with the cabinet removed, or with attachments not recommended by the manufacturer. Disconnect the TV set from AC power outlet and antenna during lightning storms.

Broken pieces:

- Do not throw anything at the TV set. The screen glass may break by the impact and cause serious injury.
- If the surface of the TV set cracks, do not touch it until you have unplugged the AC power cord. Otherwise electric shock may result.

When not in use

- If you will not be using the TV set for several days, the TV set should be disconnected from the AC power for environmental and safety reasons.
- As the TV set is not disconnected from the AC power when the TV set is just turned off, pull the plug from the AC power outlet to disconnect the TV set completely.
- However, some TV sets may have features that require the TV set to be left in standby to work correctly.

For children

- Do not allow children to climb on the TV set.
- Keep small accessories out of the reach of children, so that they are not mistakenly swallowed.

If the following problems occur...

Turn off the TV set and unplug the AC power cord immediately if any of the following problems occur.

Ask your dealer or Sony service centre to have it checked by qualified service personnel.

When:

- AC power cord is damaged.
- Poor fitting of AC power outlet.
- TV set is damaged by being dropped, hit or having something thrown at it.
- Any liquid or solid object falls through openings in the cabinet.

Precautions

Viewing the TV

- View the TV in moderate light, as viewing the TV in poor light or during long period of time, strains your eyes.
- When using headphones, adjust the volume so as to avoid excessive levels, as hearing damage may result.

LCD Screen

- Although the LCD screen is made with high-precision technology and 99.99% or more of the pixels are effective, black dots may appear or bright points of light (red, blue, or green) may appear constantly on the LCD screen. This is a structural property of the LCD screen and is not a malfunction.
- Do not push or scratch the front filter, or place objects on top of this TV set. The image may be uneven or the LCD screen may be damaged.
- If this TV set is used in a cold place, a smear may occur in the picture or the picture may become dark. This does not indicate a failure. These phenomena disappear as the temperature rises.
- Ghosting may occur when still pictures are displayed continuously. It may disappear after a few moments.
- The screen and cabinet get warm when this TV set is in use. This is not a malfunction.
- The LCD screen contains a small amount of liquid crystal. Some fluorescent tubes used in this TV set also contain mercury. Follow your local ordinances and regulations for disposal.

Handling and cleaning the screen surface/cabinet of the TV set

Be sure to unplug the AC power cord connected to the TV set from AC power outlet before cleaning.

To avoid material degradation or screen coating degradation, observe the following precautions.

- To remove dust from the screen surface/cabinet, wipe gently with a soft cloth. If dust is persistent, wipe with a soft cloth slightly moistened with a diluted mild detergent solution.
- Do not spray water or detergent directly on the TV set. It may drip to the bottom of the screen or exterior parts, and may cause a malfunction.
- Never use any type of abrasive pad, alkaline/acid cleaner, scouring powder, or volatile solvent, such as alcohol, benzene, thinner or insecticide. Using such materials or maintaining prolonged contact with rubber or vinyl materials may result in damage to the screen surface and cabinet material.
- Periodic vacuuming of the ventilation openings is recommended to ensure to proper ventilation.
- When adjusting the angle of the TV set, move it slowly so as to prevent the TV set from moving or slipping off from its table stand.

Optional Equipment

Keep optional components or any equipment emitting electromagnetic radiation away from the TV set. Otherwise picture distortion and/or noisy sound may occur.

Batteries

- Observe the correct polarity when inserting batteries.
- Do not use different types of batteries together or mix old and new batteries.
- Dispose of batteries in an environmentally friendly way. Certain regions may regulate the disposal of batteries. Please consult your local authority.
- Handle the remote with care. Do not drop or step on it, or spill liquid of any kind onto it.
- Do not place the remote in a location near a heat source, a place subject to direct sunlight, or a damp room.

Disposal of the TV set (Australian model only)



Disposal of Old Electrical & Electronic Equipment (Applicable in the European Union and other

European countries with separate collection systems)

This symbol is on the remote control.

Instructions about “Installing Wall Mount Bracket” are included within this TV’s instructions manual.



Customer Support:

<http://www.sony-asia.com/support>



<http://www.sony.net/>

4-174-286-13(1)