

Nokia 6210 Navigator User Guide

Draft

Draft April 25, 2008

CE0434

DECLARATION OF CONFORMITY

Hereby, NOKIA CORPORATION declares that this RM-419 product is in compliance with the essential requirements and other relevant provisions of Directive 1999/5/EC. A copy of the Declaration of Conformity can be found at http://www.nokia.com/phones/declaration_of_conformity/.

© 2008 Nokia. All rights reserved.

Nokia, Nokia Connecting People, Navi, Visual Radio and Nokia Care are trademarks or registered trademarks of Nokia Corporation. Nokia tune is a sound mark of Nokia Corporation. Other product and company names mentioned herein may be trademarks or tradenames of their respective owners.

Reproduction, transfer, distribution, or storage of part or all of the contents in this document in any form without the prior written permission of Nokia is prohibited.

symbian This product includes software licensed from Symbian Software Ltd © 1998–2008. Symbian and Symbian OS are trademarks of Symbian Ltd.

US Patent No 5818437 and other pending patents. T9 text input software Copyright (C) 1997–2008. Tegic Communications, Inc. All rights reserved.



Java™ and all Java-based marks are trademarks or registered trademarks of Sun Microsystems, Inc.

Portions of the Nokia Maps software are © 1996–2008 The FreeType Project. All rights reserved.

This product is licensed under the MPEG-4 Visual Patent Portfolio License (i) for personal and noncommercial use in connection with information which has been encoded in compliance with the MPEG-4 Visual Standard by a consumer engaged in a personal and noncommercial activity and (ii) for use in connection with MPEG-4 video provided by a licensed video provider. No license is granted or shall be implied for any other use. Additional information, including that related to promotional, internal, and commercial uses, may be obtained from MPEG LA, LLC. See <<http://www.mpegla.com>>.

Nokia operates a policy of ongoing development. Nokia reserves the right to make changes and improvements to any of the products described in this document without prior notice.

TO THE MAXIMUM EXTENT PERMITTED BY APPLICABLE LAW, UNDER NO CIRCUMSTANCES SHALL NOKIA OR ANY OF ITS LICENSORS BE RESPONSIBLE FOR ANY LOSS OF DATA OR INCOME OR ANY SPECIAL, INCIDENTAL, CONSEQUENTIAL OR INDIRECT DAMAGES HOWSOEVER CAUSED.

THE CONTENTS OF THIS DOCUMENT ARE PROVIDED "AS IS". EXCEPT AS REQUIRED BY APPLICABLE LAW, NO WARRANTIES OF ANY KIND, EITHER EXPRESS OR IMPLIED, INCLUDING, BUT NOT LIMITED TO, THE IMPLIED WARRANTIES OF MERCHANTABILITY AND FITNESS FOR A PARTICULAR PURPOSE, ARE MADE IN RELATION TO THE ACCURACY, RELIABILITY OR CONTENTS OF THIS DOCUMENT. NOKIA RESERVES THE RIGHT TO REVISE THIS DOCUMENT OR WITHDRAW IT AT ANY TIME WITHOUT PRIOR NOTICE.

The availability of particular products and applications and services for these products may vary by region. Please check with your Nokia dealer for details, and availability of language options.

Export controls

This device may contain commodities, technology or software subject to export laws and regulations from the US and other countries. Diversion contrary to law is prohibited.

FCC/INDUSTRY CANADA NOTICE

Your device may cause TV or radio interference (for example, when using a telephone in close proximity to receiving equipment). The FCC or Industry Canada can require you to stop using your telephone if such interference cannot be eliminated. If you require assistance, contact your local service facility. This device complies with part 15 of the FCC rules. Operation is subject to the following two conditions: (1) This device may not cause harmful interference, and (2) this device must accept any interference received, including interference that may cause undesired operation. Any changes or modifications not expressly approved by Nokia could void the user's authority to operate this equipment.

The third-party applications provided with your device may have been created and may be owned by persons or entities not affiliated with or related to Nokia. Nokia does not own the copyrights or intellectual property rights to the third-party applications. As such, Nokia does not take any responsibility for end-user support, functionality of the applications, or the information in the applications or these materials. Nokia does not provide any warranty for the third-party applications.

BY USING THE APPLICATIONS YOU ACKNOWLEDGE THAT THE APPLICATIONS ARE PROVIDED AS IS WITHOUT WARRANTY OF ANY KIND, EXPRESS OR IMPLIED, TO THE MAXIMUM EXTENT PERMITTED BY APPLICABLE LAW. YOU FURTHER ACKNOWLEDGE THAT NEITHER NOKIA NOR ITS AFFILIATES MAKE ANY REPRESENTATIONS OR WARRANTIES, EXPRESS OR IMPLIED, INCLUDING BUT NOT LIMITED TO WARRANTIES OF TITLE, MERCHANTABILITY OR FITNESS FOR A PARTICULAR PURPOSE, OR THAT THE APPLICATIONS WILL NOT INFRINGE ANY THIRD-PARTY PATENTS, COPYRIGHTS, TRADEMARKS, OR OTHER RIGHTS.

Contents

SAFETY	6	4. Write text	27
Support	8	Traditional and predictive text input.....	27
Help	8	Copy and delete text.....	28
Nokia support and contact information	8	5. Messaging	28
1. Get started	9	Write and send messages	28
Insert a (U)SIM card and battery	9	Inbox.....	29
Memory card	9	Service messages.....	29
Charge the battery	10	E-mail	30
Switch the device on and off.....	11	Outbox.....	30
Antenna locations	11	Message reader.....	31
Configuration settings	11	View messages on the SIM card	31
Welcome application.....	12	Cell broadcast	31
Settings wizard.....	12	Service commands.....	31
2. Your device	13	Messaging settings.....	31
Keys and parts	13	6. Contacts	32
Standby mode.....	14	Save and manage contact information ...	32
Indicators	15	Contact groups	33
Screen saver	16	Add a ringing tone.....	33
Menu	16	7. Positioning	33
Mark items in an application	16	About GPS	33
Switch between applications	17	Assisted GPS	34
Close an application	17	Set up GPS connection	34
Volume control	17	Position requests.....	35
Motion sensor.....	17	Maps	35
Keypad lock (keyguard)	17	Landmarks	41
Remote lock.....	18	GPS data	41
Access codes	18	8. Gallery	42
Download!.....	19	Main view	42
My own.....	19	Download files	43
Connect a compatible headset	20	View images.....	43
Connect a USB data cable	20	Edit images	43
3. Call functions	20	Edit video clips.....	43
Make a voice call	20	Print images.....	43
Answer or reject a call	22	Share online.....	43
Video calls.....	23	9. Camera	45
Call settings.....	23	Capture images.....	45
Video sharing	25	Record video clips	46
Log	26	Capture panoramic images	46

10. Media	47	Voice commands	60
Music player.....	47	Phone settings	60
Nokia Podcasting	49	Speech	62
Radio	51	16. Data management	62
RealPlayer	52	Install or remove applications.....	62
Flash Player	53	File manager	64
Recorder	53	Licences.....	64
11. Internet	53	Device manager	65
Browse the web.....	53	17. Connectivity	66
Search	56	Transfer or synchronise data.....	66
12. Personalisation	56	PC Suite.....	67
Themes.....	56	Bluetooth connectivity.....	67
Profiles.....	56	USB connection	69
13. Time management	57	Remote synchronisation.....	70
Clock.....	57	Push to talk.....	70
Calendar	57	Connection manager.....	71
14. Office applications	57	18. Enhancements	71
Active notes.....	57	19. Battery and charger	
Notes.....	58	information	72
Calculator.....	58	Nokia battery authentication guidelines.	73
Converter.....	58	Care and maintenance	74
Mobile dictionary.....	58	Additional safety information	75
Adobe Reader.....	59	Index	79
Quickoffice	59		
15. Settings	60		

SAFETY

Read these simple guidelines. Not following them may be dangerous or illegal. Read the complete user guide for further information.



SWITCH ON SAFELY

Do not switch the device on when wireless phone use is prohibited or when it may cause interference or danger.



ROAD SAFETY COMES FIRST

Obey all local laws. Always keep your hands free to operate the vehicle while driving. Your first consideration while driving should be road safety.



INTERFERENCE

All wireless devices may be susceptible to interference, which could affect performance.



SWITCH OFF IN RESTRICTED AREAS

Follow any restrictions. Switch the device off in aircraft, near medical equipment, fuel, chemicals, or blasting areas.



QUALIFIED SERVICE

Only qualified personnel may install or repair this product.



ENHANCEMENTS AND BATTERIES

Use only approved enhancements and batteries. Do not connect incompatible products.



WATER-RESISTANCE

Your device is not water-resistant. Keep it dry.

■ About your device

The wireless device described in this guide is approved for use on the GSM 850, 900, 1800, and 1900 and UMTS 850 and 1900 networks. Contact your service provider for more information about networks.

When using the features in this device, obey all laws and respect local customs, privacy and legitimate rights of others, including copyrights.

Copyright protection may prevent some images, music, and other content from being copied, modified, or transferred.

Your device supports several methods of connectivity. Like computers, your device may be exposed to viruses and other harmful content. Exercise caution with messages, connectivity requests, browsing, and downloads. Only install and use services and other software from trustworthy sources that offer adequate security and protection against harmful software, such as applications that are Symbian Signed or have passed the Java Verified™ testing.

Consider installing antivirus and other security software on your device and any connected computer.

Your device may have preinstalled bookmarks and links for third-party internet sites. You may also access other third-party sites through your device. Third-party sites are not affiliated with Nokia, and Nokia does not endorse or assume liability for them. If you choose to access such sites, you should take precautions for security or content.



Warning: To use any features in this device, other than the alarm clock, the device must be switched on. Do not switch the device on when wireless device use may cause interference or danger.

The office applications support common features of Microsoft Word, PowerPoint, and Excel (Microsoft Office 2000, XP, and 2003). Not all file formats can be viewed or modified.

Remember to make back-up copies or keep a written record of all important information stored in your device.

When connecting to any other device, read its user guide for detailed safety instructions. Do not connect incompatible products.

■ Network services

To use the phone you must have service from a wireless service provider. Many of the features require special network features. These features are not available on all networks; other networks may require that you make specific arrangements with your service provider before you can use the network services. Your service provider can give you instructions and explain what charges will apply. Some networks may have limitations that affect how you can use network services. For instance, some networks may not support all language-dependent characters and services.

Your service provider may have requested that certain features be disabled or not activated in your device. If so, these features will not appear on your device menu. Your device may also have a special configuration such as changes in menu names, menu order, and icons. Contact your service provider for more information.

This device supports WAP 2.0 protocols (HTTP and SSL) that run on TCP/IP protocols. Some features of this device, such as multimedia messaging, web browsing, and e-mail require network support for these technologies.

■ Battery removing

Always switch the device off and disconnect the charger before removing the battery.

Support

■ Help

Your device has context-sensitive help. To access help when an application is open, select **Options** > **Help**. To switch between help and the application that is open in the background, select and hold **⌘**, and select from the list of open applications.

To open help from the main menu, select **⌘** > **Help** > **Help**. Select an application to view a list of help topics, and select the related help text. To open a keyword list, select **Options** > **Search**.

■ Nokia support and contact information

Check www.nokia.com/support or your local Nokia website for the latest guides, additional information, downloads, and services related to your Nokia product.

On the website, you can get information on the use of Nokia products and services. If you need to contact Nokia Care services, check the list of local Nokia Care contact centres at www.nokia.com/customerservice.

For maintenance services, check your nearest Nokia Care point at www.nokia.com/repair.

Software updates

Nokia may produce software updates that may offer new features, enhanced functions, or improved performance. You may be able to request these updates through the Nokia Software Updater PC application. To update the device software, you need the Nokia Software Updater application and a compatible PC with Microsoft Windows 2000, XP, or Vista operating system, broadband internet access, and a compatible data cable to connect your device to the PC.

To get more information and to download the Nokia Software Updater application, visit www.nokia.com/softwareupdate or your local Nokia web site.

If software updates over the air are supported by your network, you may also be able to request updates through the device.

Downloading software updates may involve the transmission of large amounts of data through your service provider's network. Contact your service provider for information about data transmission charges.

Make sure that the device battery has enough power, or connect the charger before starting the update.

1. Get started

■ Insert a (U)SIM card and battery

This device uses BL-5F batteries.

1. To open the back cover of the device, press the back cover release button.
2. Lift the back cover to remove it.
3. To remove the battery, lift it from the end.
4. Slide the (U)SIM card into the SIM card holder. Ensure that the gold-coloured contact area on the card is facing downward on the device, and the beveled corner faces toward the card holder slot.

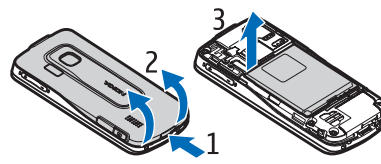

5. Replace the battery.
6. Replace the back cover.

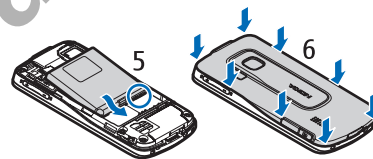
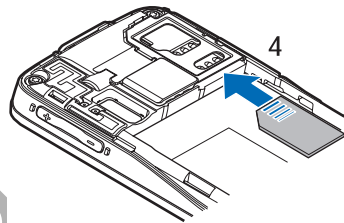

■ Memory card

Use only compatible microSD and microSDHC cards approved by Nokia for use with this device. Nokia uses approved industry standards for memory cards, but some brands may not be fully compatible with this device. Incompatible cards may damage the card and the device and corrupt data stored on the card.



Insert a memory card

Note that the memory card may be supplied with the device, and may already be inserted.

1. Open the memory card slot door.
2. Place the memory card in the slot with the gold-coloured area facing down. Push the card gently to lock it into place.
3. Close the slot door.

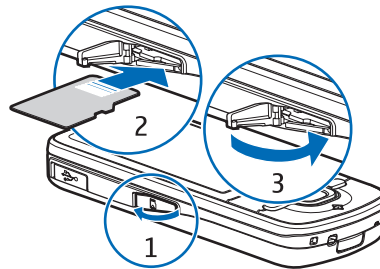

Remove a memory card



Important: Do not remove the memory card in the middle of an operation when the card is being accessed. Removing the card in the middle of an operation may damage the memory card as well as the device, and data stored on the card may be corrupted.

1. In the standby mode, briefly press the power key.
2. Scroll to *Remove memory card*, and select **OK** > **Yes**.
3. Open the memory card slot door.
4. Push the card gently to release it.
5. Pull the card out, and select **OK**.
6. Close the slot door.

Charge the battery

Your battery has been precharged but the charging levels may vary.

1. Connect the charger to the wall outlet.
2. Connect the charger to the device. You can use your device while it is charging.
3. When the battery is fully charged, disconnect the charger from the device, then from the wall outlet.

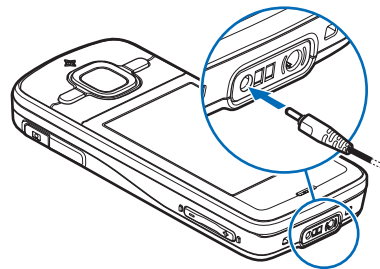

If the battery is completely discharged, it may take a few minutes before the charging indicator appears on the display or before any calls can be made.

The charging time depends on the charger and the battery used.

■ Switch the device on and off

Press and hold the power key.

If the device asks for a PIN code, enter the PIN code, and select **OK**.

If the device asks for the lock code, enter the lock code, and select **OK**. The factory setting for the lock code is 12345.

Set time and date

To set the correct time zone, time, and date, select the country you are presently in, then enter the local time and date.

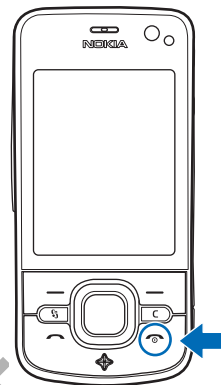

My Nokia

My Nokia is a free service that sends you tips, tricks, and support for your Nokia device regularly as text messages. If My Nokia is available in your country and supported by your service provider, your device invites you to join the My Nokia service after you have set the time and date.

Select the language for the service. If you change the language, the device restarts. To sign-up to My Nokia, select **Accept** and follow the instructions on the display.

To sign-up to My Nokia later, select  > *Applications* > *My Nokia*.

■ Antenna locations

Cellular antenna (1)

Bluetooth antenna (2)

GPS antenna (3)

Your device may have internal and external antennas. As with any radio transmitting device, avoid touching the antenna area unnecessarily while the antenna is transmitting or receiving. Contact with such an antenna affects the communication quality and may cause the device to operate at a higher power level than otherwise needed and may reduce the battery life.

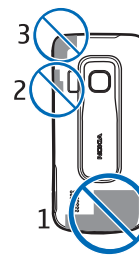

■ Configuration settings

Before you can use multimedia messaging, push to talk, e-mail, synchronisation, streaming, and the browser, you must have the proper configuration settings on

your device. Your device may automatically configure browser, multimedia messaging, access point, and streaming settings based on the SIM card used. Otherwise, you can use the [Sett. wizard](#) application to configure the settings, or you may receive the settings directly as a configuration message, which you save to your device. For more information on availability, contact your service provider or nearest authorised Nokia dealer.

When you receive a configuration message, and the settings are not automatically saved and activated, *1 new message* is displayed. To save the settings, select [Show](#) > [Options](#) > [Save](#). You may need to enter a PIN code provided by the service provider.

■ Welcome application

The [Welcome](#) application starts when you switch on your device for the first time. With the [Welcome](#) application, you can access the following applications:

[Tutorial](#) – Learn about the features of your device and how to use them. To start the tutorial later, select [Help](#) > [Tutorial](#) and a tutorial item.

[Sett. wizard](#) – Configure connection settings. See "Settings wizard," p. 12.

[E-mail settings](#) – Configure e-mail settings. See "E-mail settings," p. 32.

[Switch](#) – Copy or synchronise data from other compatible devices.

To open [Welcome](#) later, select [Help](#) > [Welcome](#).

■ Settings wizard

The setting wizard application configures your device for operator and e-mail settings based on your service provider. Configuring other settings may also be possible.

To use these services, you may have to contact your service provider to activate a data connection or other services.

Select [Settings](#) > [Sett. wizard](#).

2. Your device

■ Keys and parts

- 1 - Earpiece
- 2 - Secondary camera lens
- 3 - Light sensor
- 4 - Display
- 5 - Left and right selection keys
- 6 - Navi™ scroll key, hereafter referred to as scroll key, and status light around it
- 7 - Menu key 
- 8 - Clear key
- 9 - Call key
- 10 - Power key / end key
- 11 - Navigator key with GPS light
- 12 - Number keys
- 13 - Charger connector
- 14 - Headset connector
- 15 - Volume keys
- 16 - Camera key
- 17 - Camera flash
- 18 - Main camera lens
- 19 - Loudspeaker
- 20 - Micro USB connector
- 21 - Memory card slot
- 22 - Back cover release button
- 23 - Microphone

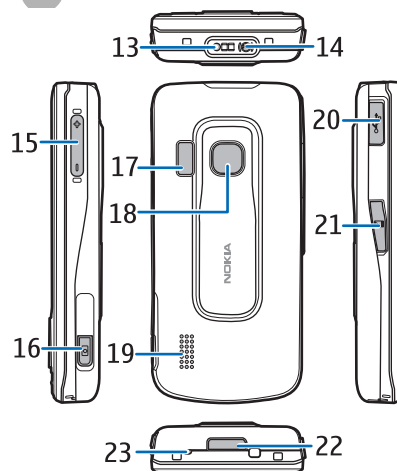
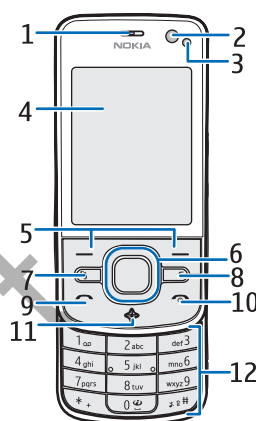

During extended operation, the device may feel warm. In most cases, this condition is normal. If you suspect the device is not working properly, take it to the nearest authorised service facility.

■ Standby mode

When you have switched on the device, and it is registered to a network, the device is in the standby mode and ready for use.

To select the view for the standby mode, select  > [Settings](#) > [Phone sett.](#) > [General](#) > [Personalisation](#) > [Standby mode](#) > [Standby theme](#).

Keep your device away from magnets or magnetic fields as they may cause some applications to activate unexpectedly.

Shortcuts in the standby mode

To open a list of most recently dialled numbers, press the call key.

To call your voice mailbox, press and hold the 1 key.

To call your video mailbox, press and hold the 2 key.

To use the voice commands or voice dialling, press and hold the right selection key.

To listen to new received messages, press and hold the left selection key until [Msg. reader](#) starts.

To change the profile, briefly press the power key, and select a profile.

To quickly change to silent profile from any other profile, in the standby mode, press and hold #.

To start a connection to the web, press and hold 0.

Depending on the selected standby theme, you can select applications or events to add to a shortcut list in the standby mode or the scroll keys. To select the applications or events, select  > [Settings](#) > [Phone sett.](#) > [General](#) > [Personalisation](#) > [Standby mode](#) > [Shortcuts](#).

Offline profile

To quickly activate the Offline profile, in the standby mode, briefly press the power key, and select [Offline](#). To leave the Offline profile, briefly press the power key, and select another profile.

When the Offline profile is active, all the connections to a cellular network are turned off. However, you can use your device without a SIM card, and listen to the radio or music using the Music Player. Remember to switch off your device when wireless phone use is prohibited.

 **Important:** In the offline profile you cannot make or receive any calls, or use other features that require cellular network coverage. Calls may still be possible to the official emergency number programmed into your device. To make calls, you must first activate the phone function by changing profiles. If the device has been locked, enter the lock code.

■ Indicators

Icons

3G or  – The device is connected to a UMTS or GSM network.

3.5G – HSDPA (network service) in the UMTS network is activated.

 – The device is in the Offline profile and not connected to a cellular network.

 – A memory card is inserted in the device.

 – You have unread messages in the inbox in Messaging.

 – You have new e-mail in your remote mailbox.

 – You have messages waiting to be sent in outbox.

 – You have missed calls.



 – *Ringing type* is set to *Silent* and *Message alert tone* and *E-mail alert tone* are set to *Off*.



 – The device keypad is locked.



 – The loudspeaker is activated.



 – An alarm is active.



 – All calls to the device are diverted to another number.

 or  – A headset or a loopset is connected to the device.

 or  or  – A GPRS packet data connection is active, or the connection is on hold, or a connection is available.

 or  or  – A packet data connection is active in a part of the network that supports EGPRS, or the connection is on hold, or a connection is available. Your device may not use EGPRS in the data transfer.

 or  or  – A UMTS packet data connection is active, or the connection is on hold, or a connection is available.

 or  – Bluetooth connectivity is switched on, or data is being transmitted using Bluetooth technology.

 – A USB connection is active.

 – The GPS receiver is active
Other indicators may also be shown.

Light indication

GPS light

The GPS light blinks when your device is trying to establish a GPS connection, and remains on when the GPS connection is established. When you close an application using GPS connection, the light blinks quickly a few times.

Status light

The status light blinks slowly for a few minutes after a missed event, such as a missed call.

You can set the status light to blink slowly to indicate when the device is switched on. The light turns on for a few second at intervals of approximately 20 seconds. To activate the status light, select  > [Settings](#) > [Phone sett.](#) > [General](#) > [Personalisation](#) > [Standby mode](#) > [Status light](#) > [On](#).

■ Screen saver

To set the screen saver settings, select  > [Settings](#) > [Phone sett.](#) > [General](#) > [Personalisation](#) > [Display](#) > [Screen saver](#). To set the timeout period after which the screen saver is activated, select [Screen saver time-out](#). To set for how long the screen saver is active, select [Screen saver duration](#).

■ Menu

In the menu you can access the functions in your device. To access the main menu, select .

To open an application or a folder, scroll to it, and press the scroll key.

If you change the order of the functions in the menu, the order may differ from the default order described in this user guide.

To change the menu view, select [Options](#) > [Change Menu view](#) and a view type.

■ Mark items in an application

To mark or unmark an item in applications, such as an image or a video clip in Gallery, press #. To mark or unmark several consecutive items, press and hold #, and scroll.

■ Switch between applications

To switch between open applications, do one of the following:

- Select **Options** > *Show open applicats.* and the application.
- Press and hold . Scroll to an application, and select it.

■ Close an application

To close an application or a folder, select **Back** and **Exit** as many times as needed to return to the standby mode, or select **Options** > *Exit*.

Leaving applications running in the background increases the demand on battery power and reduces the battery life.

■ Volume control

To adjust the earpiece or loudspeaker volume during a call or when listening to an audio file, press the volume keys. To activate or deactivate the loudspeaker during a call, select **Loudsp.** or **Handset**.



Warning: Do not hold the device near your ear when the loudspeaker is in use, because the volume may be extremely loud.

■ Motion sensor

Your device has an accelerometer that senses the movement of the device.

To edit the accelerometer settings, select  > *Settings* > *Phone sett.* > *General* > *Sensor settings*.

Display rotation

When *Sensors* is set *On* and you turn the device on its left side or back to a vertical position, the display content is rotated 90 degrees. Some applications and features may not support rotating the display content.

Turning control

To be able to silence calls and snooze alarms by turning the device so that the display faces down, select *Sensors* > *On*. Select *Turning control*, and mark *Silencing calls* and *Snoozing alarms*.

■ Keypad lock (keyguard)

To lock the keypad when you close the slide, select  > *Settings* > *Phone sett.* > *General* > *Slide handling* > *Keypad activation* > *Change* > *On when closing slide*.

To set the device to automatically lock the keypad after a certain time, select  > [Settings](#) > [Phone sett.](#) > [General](#) > [Security](#) > [Phone and SIM card](#) > [Keypad autolock period](#) > [User defined](#) and the desired time.

Opening the slide unlocks the keypad. To unlock the keypad when the slide is closed, press the left selection key and select **OK** within 1.5 seconds.

When the device or keypad is locked, calls may be possible to the official emergency number programmed into your device.

■ Remote lock

You can lock your device and memory card remotely using a text message. To enable remote locking and to define the text message content to be used, select  > [Settings](#) > [Phone sett.](#) > [General](#) > [Security](#) > [Phone and SIM card](#) > [Remote phone locking](#) > [Enabled](#). Enter the text message content (5 to 20 characters), verify it, and enter the lock code.

■ Access codes

To set how your device uses the access codes, select  > [Settings](#) > [Phone sett.](#) > [General](#) > [Security](#) > [Phone and SIM card](#).

Lock code

The lock code (5 digits) helps to lock your device. The preset code is 12345. Change the code, keep the new code secret and in a safe place separate from your device.

To change the lock code, select  > [Settings](#) > [Phone sett.](#) > [General](#) > [Security](#) > [Phone and SIM card](#) > [Lock code](#). To activate the automatic locking of your device, select [Phone autolock period](#) > [User defined](#).

If you forget the code and your device is locked, your device will require service and additional charges may apply. For more information, contact a Nokia Care point or your device dealer.

When the device or keypad is locked, calls may be possible to the official emergency number programmed into your device.

PIN codes

The personal identification number (PIN) code or the universal personal identification number (UPIN) code (4 to 8 digits) help to protect your SIM card. The (U)PIN code is usually supplied with the SIM card. Set the device to request the code each time the device is switched on, select  > [Settings](#) > [Phone sett.](#) > [General](#) > [Security](#) > [Phone and SIM card](#) > [PIN code request](#) > [On](#).

The PIN2 code may be supplied with the SIM card and is required for some functions.

The module PIN is required to access the information in the security module. The signing PIN is required for the digital signature. The module PIN and the signing PIN are supplied with the SIM card if the SIM card has a security module in it.

PUK codes

The personal unblocking key (PUK) code or the universal personal unblocking key (UPUK) code (8 digits) are required to change a blocked PIN code and UPIN code, respectively. The PUK2 code is required to change a blocked PIN2 code.

If needed, contact your local service provider for the codes.

Barring password

The barring password (4 digits) is required when using call barring. You can obtain the password from your service provider. If the password is blocked, contact your service provider.

■ Download!

Download! (network service) is a mobile content shop available on your device.

With Download! you can discover, preview, buy, download, and upgrade content, services, and applications. The items are categorised under catalogs and folders provided by different service providers. The available content depends on your service provider.

Select  > *Applications* > *Download!*.

Download! uses your network services to access the most up-to-date content. For information on additional items available through Download!, contact your service provider, or the supplier or manufacturer of the item.

■ My own

You can install applications to your device. To access the applications, select  > *Applications* > *My own*.



Important: Only install and use applications and other software from trusted sources, such as applications that are Symbian Signed or have passed the Java Verified™ testing.

■ Connect a compatible headset

Do not connect products that create an output signal as this may cause damage to the device. Do not connect any voltage source to the Nokia AV Connector.

When connecting any external device or any headset, other than those approved by Nokia for use with this device, to the Nokia AV Connector, pay special attention to volume levels.

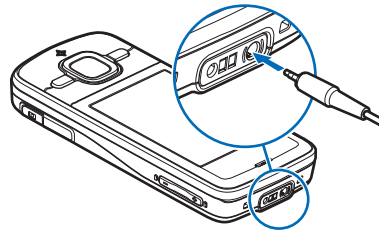

■ Connect a USB data cable

Connect a compatible USB data cable to the USB connector.

To select the default USB connection mode or change the active mode, select  > *Settings* > *Connectivity* > *USB* > *USB connection mode* and the desired mode. To set whether the default mode is activated automatically, select *Ask on connection* > *No*.

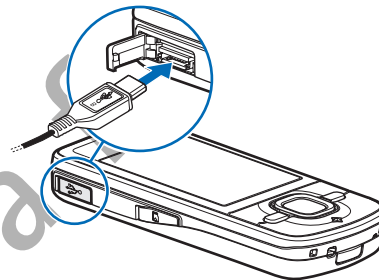

3. Call functions

To adjust the volume during a call, press the volume keys.

■ Make a voice call

1. In the standby mode, enter the phone number, including the area code. Press the clear key to remove a number.

For international calls, press * twice for the international prefix (the + character replaces the international access code), and enter the country code, area code (omit the leading zero if necessary), and phone number.

2. To call the number, press the call key.
3. To end the call, or to cancel the call attempt, press the end key.

To select whether active calls are ended when closing the slide, select  > *Settings* > *Phone sett.* > *General* > *Slide handling* > *Closing the slide* > *Change* > *End active call* or *Continue active call*

To make a call from Contacts, select  > [Contacts](#). Scroll to the desired name; or enter the first letters of the name, and scroll to the desired name. To call the number, press the call key.

To call a recently dialled number from the standby mode, press the call key.

Speed dialling

Speed dialling is a quick way to call frequently used numbers from the standby mode. You need to assign a phone number to the speed dialling keys 3 to 9 (the 1 and 2 keys are reserved for the voice and video call mailboxes), and set [Speed dialling](#) to [On](#).

To assign a phone number to a speed dialling key, select  > [Settings](#) > [Speed dial](#). Scroll to a key icon, and select [Assign](#) and the contact. To change the number, select [Options](#) > [Change](#).

To activate the speed dialling, select  > [Settings](#) > [Phone sett.](#) > [Phone](#) > [Call](#) > [Speed dialling](#) > [On](#).

To call a speed dialling number, press and hold the speed dialling key until the call begins.

Call mailbox

To call your voice or video mailboxes (network service), from the standby mode, press and hold 1 or 2. You can have call mailboxes for voice calls, video calls, and multiple phone lines.

To define the call mailbox number if no number is set, select  > [Settings](#) > [Call mailbox](#). Scroll to [Voice mailbox](#) (or [Video mailbox](#)), and enter the corresponding mailbox number. To change the call mailbox number, select [Options](#) > [Change number](#). For the call mailbox number, contact your service provider.

Voice dialling

A voice tag is added automatically to all entries in Contacts. Use long names, and avoid similar names for different numbers.

Make a voice dialling call

Voice tags are sensitive to background noise. Use voice tags in a quiet environment.



Note: Using voice tags may be difficult in a noisy environment or during an emergency, so you should not rely solely upon voice dialling in all circumstances.

1. In the standby mode, press and hold the right selection key.

If you are using a compatible headset with the headset key, press and hold the headset key.

2. When *Speak now* is displayed, speak the voice command clearly. The device plays the voice command of the best match. After 1.5 seconds, the device dials the number; if the result is not the correct one, before dialling select another entry.

Make a conference call

Your device supports conference calls (network service) between a maximum of six participants, including yourself.

1. Make a call to the first participant.
2. To make a call to another participant, select **Options** > *New call*.
3. To create the conference call when the new call is answered, select **Options** > *Conference*.

To add another person to the conference call, repeat step 2, and select **Options** > *Conference* > *Add to conference*.

4. To end the conference call, press the end key.

■ Answer or reject a call

To answer a call, press the call key.

To mute the ringing tone, select *Silence*.

To reject the call, press the end key, or select **Options** > *Reject*. If you have activated *Call divert* > *If busy*, rejecting the call diverts the call.

To send a text message as a reply to the caller instead of answering the call, select **Options** > *Send message*. To activate the text message reply and edit the message, select  > *Settings* > *Phone sett.* > *Phone* > *Call* > *Reject call with message* and *Message text*.

To determine whether calls are answered automatically when opening the slide, select  > *Settings* > *Phone sett.* > *General* > *Slide handling* > *Opening the slide* > *Change* > *Answer incoming call* or *Call not answered*.

Call waiting

During a call, to answer the waiting call, press the call key. The first call is put on hold. To switch between the two calls, select **Swap**. To end the active call, press the end key.

To activate the call waiting function (network service), select  > [Settings](#) > [Phone sett.](#) > [Phone](#) > [Call](#) > [Call waiting](#) > [Activate](#).

■ Video calls

Make a video call

To make a video call, you may need to have a USIM card and be within the coverage of a UMTS network. For availability of and subscription to video call services, contact your service provider. A video call can only be made between two parties and when no other voice, video, or data calls are active. The video call can be made to a compatible mobile phone or an ISDN client.

 You have captured a still image to be sent instead of video sending.

 You have denied video sending from your device.

1. Enter the phone number in the standby mode and select [Video call](#). Or, select  > [Contacts](#), scroll to the desired contact, and select [Options](#) > [Video call](#).
2. To change between showing video or only hearing sound during a video call, select from the toolbar [Enable video sending](#) or [Disable video sending](#).

If you have denied video sending during a video call, the call is still charged as a video call. Check the pricing with your network operator or service provider.

3. To end the video call, press the end key.

Answer a video call

When a video call arrives,  is displayed.

To answer the video call, press the call key. [Allow video image to be sent to caller?](#) is shown. If you select [Yes](#), the image captured by the camera in your device is shown to the caller. Otherwise, video sending is not activated.

If you have denied video sending during a video call, the call is still charged as a video call. Check the pricing with your service provider.

To end the video call, press the end key.

■ Call settings

Call

Select  > [Settings](#) > [Phone sett.](#) > [Phone](#) > [Call](#) and from the following:

[Send my caller ID](#) (network service) — to display or hide your phone number from the person to whom you are calling

Call waiting (network service) – See "Call waiting," p. 22.

Reject call with message and *Message text* – See "Answer or reject a call," p. 22.

Own video in recvd. call – to set whether you allow to send your own video image when you receive a video call

Image in video call – to select a still image to be shown when you deny a video call

Automatic redial – to set your device to make a maximum of 10 attempts to connect the call after an unsuccessful call attempt

Show call duration and *Summary after call* – to set the device to display the call duration during a call and the approximate duration of the last call

Speed dialling – See "Speed dialling," p. 21.

Anykey answer – to answer an incoming call by briefly pressing any key, except the left and right selection keys, volume keys, and end key

Line in use (network service) – to select the phone lines for making calls and sending short messages. This is shown only if the SIM card supports two phone lines.

Line change (network service) – to enable or disable the line selection

Call divert

1. Select  > *Settings* > *Phone sett.* > *Phone* > *Call divert* (network service).
2. Select which calls you want to divert, for example, *Voice calls*.
3. Select the desired option. For example, to divert voice calls when your number is busy or when you reject an incoming call, select *If busy*.
4. Select *Options* > *Activate* and the phone number to which you want to divert the calls. Several divert options can be active at the same time.

Call barring and call diverting cannot be active at the same time.

Call barring

1. Select  > *Settings* > *Phone sett.* > *Phone* > *Call barring* (network service) to restrict the calls that you make and receive with your device.
2. Scroll to the desired barring option, and select *Options* > *Activate*. To change the settings, you need the barring password given by your service provider.

Call barring and call diverting cannot be active at the same time.

When calls are barred, calls may be possible to certain official emergency numbers.

Network

Select  > [Settings](#) > [Phone sett.](#) > [Phone](#) > [Network](#) and from the following:

[Network mode](#) – to select which network to use (this is shown only if it is supported by the service provider). If you select [Dual mode](#), the device uses the GSM or UMTS network automatically.

[Operator selection](#) – to set the device to search for and automatically select one of the available networks, select [Automatic](#). To select the desired network manually from a list of networks, select [Manual](#). The selected network must have a roaming agreement with your home network.

[Cell info display](#) (network service) – to set the device to indicate when it is used in a cellular network based on microcellular network (MCN) technology, and to activate cell info reception

■ [Video sharing](#)

Use video sharing to send live video from your mobile device to another compatible mobile device during a voice call.

Video sharing requirements

Video sharing requires a 3G universal mobile telecommunications system (UMTS) connection. For information about network availability and the fees associated with this application, contact your service provider.

To use video sharing you must do the following:

- Ensure that your device is set up for person-to-person connections.
- Ensure that both the sender and recipient are registered to the UMTS network.
- Ensure you have an active UMTS connection and you are within UMTS network coverage. If you move away from a UMTS network during the sharing session, the sharing session is discontinued, but your voice call continues.

Video sharing settings

A person-to-person connection is also known as a session initiation protocol (SIP) connection. Before you can use video sharing, ask your service provider for the configured SIP profile to be used in your device.

Select  > [Settings](#) > [Phone sett.](#) > [Connection](#) > [Video sharing](#) and from the following:

[Video sharing](#) – to select whether the video sharing is enabled

[SIP profile](#) – to select a SIP profile

Video saving – to set whether the live videos are automatically saved

Preferred saving memory – to select whether to save the videos to the device memory or to a memory card

Capability alert tone – to set an alert tone to sound when video sharing is available during a call

If you know a recipient's SIP address, you can save it to Contacts. Select  > *Contacts*, the contact, and *Options* > *Edit* > *Options* > *Add detail* > *SIP* or *Share video*. Enter the SIP address (username@domainname). You can use an IP address instead of a domain name.

Share live video or video clip

1. To share live video you are recording with the device camera, select *Options* > *Share video* > *Live video* during a voice call. To share a saved video clip, select *Video clip* and the clip you want to share.
2. The device sends the invitation to the SIP address you saved to Contacts.
If necessary, to send the invitation, select the SIP address of the recipient; or enter a SIP address, and select **OK**.
3. Sharing begins automatically when the recipient accepts the invitation, and the loudspeaker is active. Use the toolbar buttons to control the video sharing.
4. To end the sharing session, select **Stop**. To end the voice call, press the end key.

Accept an invitation

Your device rings when you receive an invitation. The invitation shows the sender's name or SIP address. Select **Yes** to begin the sharing session. To decline the invitation and to return to the voice call, select **No**.

■ Log

To view missed, received, or dialled calls; text messages; packet data connections; and fax and data calls registered by the device, select  > *Log*.

In the standby mode, you can use the call key as a shortcut to *Dialled numbers* in the *Recent calls* log (network service).





Note: The actual invoice for calls and services from your service provider may vary, depending on network features, rounding off for billing, taxes, and so forth.



Note: Some timers, including the life timer, may be reset during service or software upgrades.

4. Write text

■ Traditional and predictive text input

When you write text,  on the display indicates predictive text input and  traditional text input. To set the predictive text input on or off, press # repeatedly, or press *, and select *Activate predictive text* or *Predictive text > Off*.

Abc, abc, ABC or **123** next to the text input indicator indicates the character case or number mode. To change the character case, or to change between letter and number mode, press # repeatedly.

To change the writing language of your device, select  > *Settings* > *Phone sett.* > *General* > *Personalisation* > *Language* > *Writing language*. The writing language affects the characters available when writing text and the predictive text dictionary used. Not all characters available under a number key are printed on the key.

Write with traditional text input

Press a number key, 2 to 9, repeatedly until the desired character appears. Press the 1 key for the most common punctuation marks and special characters.

If the next letter you want is on the same key as the present one, wait until the cursor appears (or scroll forward to end the time-out period), and enter the letter.

Write with predictive text input

1. Press a number key, 2–9, only once for one letter. The word changes after every keypress. For the most common punctuation marks, press 1.
2. When you have finished the word and it is correct, to confirm it, scroll forward or insert a space.

If the word is not correct, to view the matching words the dictionary has found one by one, press * repeatedly.

If the ? character is shown after the word, the word you intended to write is not in the dictionary. To add a word to the dictionary, select *Spell*. Enter the word (up to 32 letters), and select *OK*. The word is added to the dictionary.

When the dictionary becomes full, a new word replaces the oldest added word.

Common functions in traditional and predictive text input

To insert a number, press and hold the number key.

To enter punctuation marks and special characters, press and hold *.

To erase a character, press the clear key. To erase more characters, press and hold the clear key.

To insert a space, press **O**. To move the cursor to the next line, press **O** three times.

■ Copy and delete text

1. To select letters and words, press and hold **#**, and at the same time scroll left or right. To select lines of text, press and hold **#**, and at the same time scroll up or down.
2. To copy the text, press and hold **#**, and at the same time select **Copy**.
To delete the selected text, press the clear key.
3. To insert the text, scroll to the insertion point, press and hold **#**, and at the same time select **Paste**.

5. Messaging

Before you can receive or send messages or e-mail, you must have the necessary settings and access points defined. Contact your service provider for the settings.

■ Write and send messages

Your device supports the sending of text messages beyond the character limit for a single message. Longer messages are sent as a series of two or more messages. Your service provider may charge accordingly. Characters that use accents or other marks, and characters from some language options, take up more space, limiting the number of characters that can be sent in a single message.

The wireless network may limit the size of MMS messages. If the inserted picture exceeds this limit, the device may make it smaller so that it can be sent by MMS.

Only devices that have compatible features can receive and display multimedia messages. The appearance of a message may vary depending on the receiving device.

1. Select  > **Messaging** > **New message** and the message type. To create a text message or multimedia message, select **Message**. The message type changes automatically based on the content.
2. In the **To** field, enter the phone numbers or e-mail addresses of the recipients, or, to select recipients from Contacts, press the scroll key. Separate recipients with a semicolon (;).

3. To enter the subject for a multimedia, or e-mail message, scroll down to the *Subject* field. If the subject field is not visible for a multimedia message, select *Options* > *Message header fields*, mark *Subject*, and select *OK*.
4. Scroll down to the message field and enter the message content.

When you write a text message, the message length indicator shows how many characters you can enter in the message. For example, 10 (2) means that you can still add 10 characters for the text to be sent as a series of two text messages.

To insert an object, such as an image, video clip, note, or a business card, to a multimedia, or e-mail message, press the scroll key, and select *Insert content*.

To record a new sound clip for an audio message, select *Record*. To use a previously recorded sound clip, select *Options* > *Insert sound clip* > *From Gallery*.
5. To send the message, select *Options* > *Send*.

■ Inbox

Inbox contains received messages except e-mail and cell broadcast messages. To read received messages, select  > *Messaging* > *Inbox* and the message.

To view the list of media objects that are included in the multimedia message, open the message, and select *Options* > *Objects*.

Your device can receive many kinds of messages, such as operator logos, business cards, calendar entries, and ringing tones. You can save the special message content to your device. For example, to save a received calendar entry to the calendar, select *Options* > *Save to Calendar*.



Note: The picture message function can be used only if it is supported by your service provider. Only compatible devices that offer picture message features can receive and display picture messages. The appearance of a message may vary depending on the receiving device.

■ Service messages

Service messages (network service) are notifications that may contain a text message or the address of a browser service.

To define whether service messages are enabled and whether the messages are downloaded automatically, select  > *Messaging* > *Options* > *Settings* > *Service message*.

■ E-mail

When you create a new mailbox, the name you give to the mailbox replaces New mailbox. You can have up to six mailboxes.

IMAP4 and POP3 mailboxes

Select  > *Messaging* and the mailbox. *Connect to mailbox?* is displayed. To connect to your mailbox (network service), select *Yes*, or to view previously retrieved e-mail messages offline, select *No*.

To connect to the mailbox afterwards, select *Options* > *Connect*. When you are online, to end the data connection to the remote mailbox, select *Options* > *Disconnect*.

Retrieve and read e-mail messages

1. Select *Options* > *Retrieve e-mail* and whether you want to retrieve new, selected, or all messages.
2. To open an e-mail message, select it.
To view e-mail attachments, indicated with , select *Options* > *Attachments*.
You can open, save or send attachments in supported formats.

Delete e-mail messages

To delete an e-mail message from the device and retain it in the remote mailbox, select *Options* > *Delete* > *Phone only*. To delete an e-mail from both the device and the remote mailbox, select *Options* > *Delete* > *Phone and server*.

To cancel deletion of an e-mail from both the device and server, scroll to an e-mail that has been marked to be deleted during the next connection, and select *Options* > *Restore*.

Sync mailboxes

Select  > *Messaging* and the sync mailbox.

To synchronise your device with the remote mailbox, select *Options* > *Synchronisation* > *Start*.

To view received messages, select *Inbox* and the message.

■ Outbox

The outbox folder is a temporary storage place for messages that are waiting to be sent. To access the outbox folder, select  > *Messaging* > *Outbox*.

To retry sending a message, scroll to the message and select *Options* > *Send*.

To postpone sending a message, scroll to a message, and select **Options** > *Defer sending*.

■ Message reader

To listen to a message in Inbox or a mailbox, scroll to the message or mark the messages, and select **Options** > *Listen*.



Tip: When you have received a new message, to listen to the received messages, in the standby mode, press and hold the left selection key until *Msg. reader* starts.

To select the default language and voice used for reading messages, and adjust the voice properties, such as rate and volume, select  > **Settings** > *Speech*.

To select other settings for the message reader, in *Speech*, scroll right to *Settings*.

■ View messages on the SIM card

Before you can view SIM messages, you need to copy them to a folder in your device. Select  > **Messaging** > **Options** > *SIM messages*, mark the messages you want to copy, and select **Options** > *Copy* and the folder to which you want to copy the messages.

■ Cell broadcast

Check with your service provider whether cell broadcast (network service) is available and what the available topics and related topic numbers are.

Select  > **Messaging** > **Options** > *Cell broadcast*. To activate the service, select **Options** > **Settings** > *Reception* > *On*.

■ Service commands

To enter and send service commands (also known as USSD commands) such as activation commands for network services to your service provider, select  > **Messaging** > **Options** > *Service commands*. To send the command, select **Options** > *Send*.

■ Messaging settings

Text message settings

To define text message settings, such as the message centre and character encoding used, select  > **Messaging** > **Options** > **Settings** > *Text message*.

Multimedia messaging settings

To define multimedia message settings, such as which access point is used and whether multimedia messages are retrieved automatically, select  > [Messaging](#) > [Options](#) > [Settings](#) > [Multimedia message](#).

E-mail settings

Select  > [Messaging](#) > [Options](#) > [Settings](#) > [E-mail](#) > [Mailboxes](#), the mailbox and from the following:

[Connection settings](#) – to define the connection settings, such as the servers and protocol used

[User settings](#) – to define user settings, such as when messages are sent and whether to include a signature

[Retrieval settings](#) – to define retrieval settings, such as which parts of the messages are retrieved and how many messages are retrieved

[Automatic retrieval](#) – to define settings for retrieving messages automatically at set intervals or when an e-mail notification is received from the server

Other settings

To define whether a specified number of sent messages are saved to the Sent folder and whether to store the messages in the device memory or memory card, select  > [Messaging](#) > [Options](#) > [Settings](#) > [Other](#).

6. Contacts

■ Save and manage contact information

To save and manage contact information, such as names, phone numbers, and addresses, select  > [Contacts](#).

To add a new contact, select [Options](#) > [New contact](#). Fill in the fields you want, and select [Done](#).

To set your device to show contacts in the device memory and in the SIM card in the list of contacts, select [Options](#) > [Settings](#) > [Contacts to display](#), and mark [Phone memory](#) and [SIM memory](#).

To copy names and numbers from a SIM card to your device or vice versa, scroll to the contact (or mark the desired contacts), and select [Options](#) > [Copy](#) > [Phone memory](#) or [SIM memory](#).

To view information about the memory consumption of contacts, select **Options** > **Contacts info**.

To view the list of fixed dialling numbers, select **Options** > **SIM numbers** > **Fixed dial contacts**. This setting is only shown if supported by your SIM card.

When fixed dialling is activated, calls may be possible to the official emergency number programmed into your device.

To assign default numbers and addresses to a contact, select it, and select **Options** > **Defaults**. Scroll to the desired default option, and select **Assign**.

■ Contact groups

To create a contact group so that you can send text or e-mail messages to several recipients at the same time, select **☰** > **Contacts**. Scroll right, and select **Options** > **New group**. Enter a name for the group, and open the group. Select **Options** > **Add members**. Mark the contacts you want to add to the group, and select **OK**.

■ Add a ringing tone

You can set a ringing tone or a video ringing tone for each contact and group. To add a ringing tone to a contact, select **☰** > **Contacts**, and open the contact. Select **Options** > **Ringling tone** and the ringing tone. To add a ringing tone to a group, scroll right to the groups list, and scroll to a contact group. Select **Options** > **Ringling tone** and the ringing tone for the group. To remove the personal or group ringing tone, select **Default tone** as the ringing tone.

7. Positioning

You can use applications such as **Maps** and **GPS data** to find out your location, or measure distances and coordinates. These applications require a GPS connection.

■ About GPS

The Global Positioning System (GPS) is a worldwide radio navigation system that includes 24 satellites and their ground stations that monitor the operation of the satellites.

Your device has an internal GPS receiver.

The Global Positioning System (GPS) is operated by the government of the United States, which is solely responsible for its accuracy and maintenance. The accuracy of location data can be affected by adjustments to GPS satellites made by the United States government and

is subject to change with the United States Department of Defense civil GPS policy and the Federal Radionavigation Plan. Accuracy can also be affected by poor satellite geometry. Availability and quality of GPS signals may be affected by your location, buildings, natural obstacles, and weather conditions. The GPS receiver should only be used outdoors to allow reception of GPS signals.

Any GPS should not be used for precise location measurement, and you should never rely solely on location data from the GPS receiver and cellular radio networks for positioning or navigation.

■ Assisted GPS

Assisted GPS (A-GPS) is used to retrieve assistance data over a packet data connection, which assists in calculating the coordinates of your current location when your device is receiving signals from satellites.

Your network operator may charge you for this connection according to your network subscription. Contact your service provider for the correct internet access point and charges related to the service.

To enable or disable a positioning method, such as A-GPS, select  > [Settings](#) > [Phone sett.](#) > [General](#) > [Positioning](#) > [Positioning methods](#), the positioning method, and [Enable](#) or [Disable](#).

Your device is preconfigured to use the Nokia A-GPS service, if no service provider-specific A-GPS settings are available. The assistance data is retrieved from the Nokia A-GPS service server only when needed.

To use A-GPS, you must have a packet data internet access point defined. Your device asks for the internet access point when A-GPS is used for the first time. To define the access point, see "Positioning settings," p. 34.

■ Set up GPS connection

Positioning settings

Select  > [Settings](#) > [Phone sett.](#) > [General](#) > [Positioning](#) and from the following:

[Positioning methods](#) – to enable or disable different positioning methods

[Positioning server](#) – to define an access point for A-GPS, select [Access point](#). Only a packet data internet access point can be used. Your device asks for the internet access point when A-GPS is used for the first time. To select whether to allow automatic connections to the positioning server, to be asked every time, or to never connect to the positioning server, select [Positioning server use](#). To define the server used, select [Server address](#).

[Notation preferences](#) – to define the measurement system and coordinate format

Hold your device correctly

When using the receiver, from an upright position, move the device to an angle of about 45 degrees, with an unobstructed view of the sky.

Establishing a GPS connection may take from a couple of seconds to several minutes, even longer in a vehicle. See "GPS light," p. 16.

Using the GPS receiver may drain the device battery faster.

If your device cannot find the satellite signal, consider the following:

- If you are indoors, go outdoors to receive a better signal.
- If you are outdoors, move to a more open space.
- Check that your hand does not cover the GPS receiver of your device.
- If the weather conditions are bad, the signal strength may be affected.
- Some vehicles have tinted (athermic) windows, which may block the satellite signals.

Satellite signal status

To check how many satellites your device has found, and whether your device is receiving satellite signals, select  > [Applications](#) > [GPS data](#) > [Position](#) > [Options](#) > [Satellite status](#).

If your device has found satellites, a bar for each satellite is shown in the satellite information view. When your device has received enough data from the satellite signal to calculate the coordinates of your location, the bars turn grey.

■ Position requests

You may receive a request from a network service to receive your position information. Service providers may offer information about local topics, such as weather or traffic conditions, based upon the location of your device.

When you receive a position request to allow your position information to be sent, select [Accept](#), or to deny the request, select [Reject](#).

■ Maps

The map coverage varies by country or region. For example, maps may not be available due to legal restrictions of countries or regions. To the maximum extent permitted by applicable law, Nokia disclaims any and all warranty with respect to the availability, accuracy, correctness or update of maps.

About Maps

With Maps, you can see your current location on the map, browse maps for different cities and countries, navigate to a destination with voice guidance, search for addresses and different points of interest, plan routes from one location to another, and save locations as landmarks and send them to compatible devices. You can also purchase extra services, such as travel guides and traffic information. These services are not available in all countries or regions.

Some maps may be pre-loaded on the memory card in your device. You can download more maps through the internet using Nokia Map Loader PC software. See "Download maps," p. 38.

Maps uses GPS. You can define the positioning methods used with your device. See "Positioning settings," p. 34. For the most accurate location information, use either the internal GPS or a compatible external GPS receiver.

Browse maps

To start *Maps*, press the Navigator key.

When you use Maps for the first time, you may need to select a cellular access point for downloading map information for your current location. To change the default access point later, select [Options](#) > [Tools](#) > [Settings](#) > [Internet](#) > [Network destination](#).

To receive a note when your device registers to a network outside your home network, select [Options](#) > [Tools](#) > [Settings](#) > [Internet](#) > [Roaming warning](#) > [On](#). For details and roaming costs, contact your network service provider.

The data transfer indicator shows the internet connection used and the amount of data transferred since the application started.

Almost all digital cartography is inaccurate and incomplete to some extent. Never rely solely on the cartography that you download for use in this device.

When you open Maps, it shows the location that was saved from your last session or the capital of the country you are in. The map of the location is also downloaded, if needed.

To establish a GPS connection and zoom in to your last known location, press the navigator key, or select [Options](#) > [My position](#).

A GPS indicator () shows the availability and strength of the satellite signal. One bar indicates one satellite. When the device receives enough data from the satellite to establish a GPS connection, the bar turns green. Your device must receive signals from at least four satellites to calculate the coordinates of

your location. After the initial calculation, signals from three satellites may be enough.

To zoom in or out, press * or #. To move on the map, use the scroll key. A new map is automatically downloaded if you scroll to an area which is not covered by maps already downloaded. See "Download maps," p. 38. The maps are free of charge, but downloading may involve the transmission of large amounts of data through your service provider's network. For more information on data transmission charges, contact your service provider. The maps are automatically saved in the device memory or on a compatible memory card (if inserted).

Compass

Your device has a magnetic compass.

The compass should always be properly calibrated. Electromagnetic fields, large metal objects, and other external circumstances may reduce the accuracy of the compass. Never rely solely on the device compass.

To enable the compass and try to find your current position, press the navigator key. If the circle around the compass is red, the compass is not calibrated. To calibrate the compass, rotate the device around all axes with your wrist in a continuous movement until the circle is green. When you rotate the device, make sure that the device display momentarily faces toward the ground.

If the circle is yellow, the calibration accuracy is low, and you should continue rotating the device. When the compass is enabled and the circle around the compass is green, the map view turns automatically according to which direction the top of the device is pointing.

To enable or disable the compass, select **Options > Tools > Turn compass on** or **Turn compass off**. When the compass is not in use, the circle around the compass is white and the map view does not turn automatically.

Find locations

To find a location in the city or area displayed on the map, enter the full or partial address of the location in the search field, and select **Search**. To find a location in another city, enter the city and the full or partial address, and select **Search**. If possible, write the name of city in the local language or English. If you are unsure

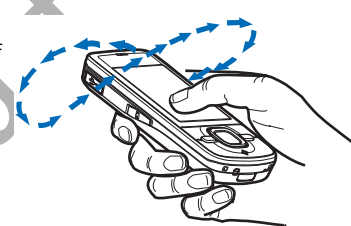

of the address, enter the only first three characters of the address. To find a city in a different country, enter the country's name in English or the three-letter ISO country code and the city. For example, to find London using the country code, enter **GBR London**, and select **Search**.

To find a specific address, select **Options** > **Search** > **Addresses**. **Country/Region** and **City or post code** are mandatory.

To browse through or search for places and attractions in your area, select **Options** > **Search** > **Places** and a category. For example, to find a hotel, select **Options** > **Search** > **Places** > **Accommodation**. To find a hotel by its name, enter the name, and select **Search**, or to browse the hotels, select a category or **Search all**.

To find an address saved in Contacts, select **Options** > **Search** > **Addresses** > **Options** > **Select from Contacts**.

Save and send locations

To save a location to your device, press the scroll key, and select **Add to my places**.

To send a location to a compatible device, press the scroll key, and select **Send**. If you send the location in a text message, the information is converted to plain text.

View your saved items

To view the locations or routes you have saved to your device, select **Options** > **Favourites** > **My places** or **Routes**. Locations saved in **Landmarks** are displayed in **My places**.

To check which locations you have searched for on the map, select **Options** > **Favourites** > **History**.

To create a collection of your favourite places, select **Options** > **Favourites** > **Collections** > **New collection**. Enter the name for the collection. To add locations to your collection, open **My places**, scroll to a location, press the scroll key, and select **Add** > **To collection**.

Download maps

When you browse a map in Maps, a new map is automatically downloaded if you scroll to an area which is not covered by maps already downloaded. The data counter (kB) shows the amount of network traffic when you browse maps, create routes, or search for locations online.

Downloading maps may involve the transmission of large amounts of data through your service provider's network. Contact your service provider for information about data transmission charges.

To prevent automatic downloading of maps, for example, when outside your home network, select **Options** > **Tools** > **Settings** > **Internet** > **Go online at start-up** > **No**.

To define the memory to be used and how much memory space you want to use for saving maps or voice guidance files, select **Options** > **Tools** > **Settings** > **Map** > **Memory to be used** and **Maximum memory use**. When the memory is full, the oldest map data is deleted. The saved maps data can be deleted using Nokia Map Loader PC software.

Nokia Map Loader

Nokia Map Loader is PC software that you can use to download and install maps and extra services from the internet to a compatible memory card. Use the Maps application and browse maps at least once before using Nokia Map Loader, as Nokia Map Loader uses the Maps history information.

To install Nokia Map Loader to a compatible PC, see <http://maps.nokia.com>, and follow the instructions on the screen.

Plan a route

To plan a route, select a location on the map or search for a location, press the scroll key, and select **Add** > **To route**.

To add more locations for your route, select **Options** > **Add route point**, and search for the location.

To edit the route, press the scroll key, and select **Edit route**.

To define the settings for the route, select **Options** > **Settings**.

To show the route on the map, select **Options** > **Show route**.

To navigate to the destination by car or on foot, select **Options** > **Start driving** or **Start walking**.

To save the route, select **Options** > **Save route**.

Activate navigation licence

Before you can use the navigation feature, you have to activate the licence online using an internet access point. To activate the licence for both car and pedestrian navigation, select **Options** > **Extras** > **Drive & Walk**, and follow the instructions.

Navigate to the destination

To start navigating, select a location, press the scroll key, and select [Drive to](#) or [Walk to](#).

When you use car navigation for the first time, your device may ask you to select the language for the voice guidance. To change the language later, in the Maps main view, select [Options](#) > [Tools](#) > [Settings](#) > [Navigation](#) > [Voice guidance](#). Voice guidance is not available for pedestrian navigation.

To switch between different map views during the navigation, press the scroll key, and select [Manoeuvre view](#), [Bird's-eye view](#), or [Arrow view](#).

To discard the created route and use another route, select [Options](#) > [Diff. route](#).

To stop navigating, select [Options](#) > [Stop](#).

Extra services for Maps

Traffic and guide information and related services are generated by third parties independent of Nokia. The information may be inaccurate and incomplete to some extent and is subject to availability. Never rely solely on the aforementioned information and related services.

Downloading extra services may involve the transmission of large amounts of data through your service provider's network. Contact your service provider for information about data transmission charges.

Traffic information

The real-time traffic information service is an extra service that provides information about events that may affect your travel. You can purchase the service and download it to your device if available in your country or region.

To purchase a licence for the traffic information service, select [Options](#) > [Extras](#) > [Traffic info](#).

To view information about traffic events, select [Options](#) > [Traffic info](#). The events are shown on the map as triangles and lines.

To view details of an event, including possible rerouting options, select the event and [Options](#) > [Open](#).

To update the traffic information, select [Update traffic info](#).

Travel guides

To purchase and download travel guides, or to view downloaded ones, select [Options](#) > [Extras](#) > [Guides](#).

To browse travel guide categories, select a category. If there are subcategories, select a subcategory.

To download a new guide to your device, scroll to the desired guide, and select **Yes**. You can pay for the guides using a credit card or in your phone bill, if supported by your service provider.

■ Landmarks

Select  > **Landmarks**. With Landmarks, you can save the position information of specific locations to your device. You can use your saved landmarks in compatible applications, such as **GPS data** and **Maps**. In Maps, saved landmarks are available in **Myplaces**.

To create a new landmark, select **Options** > **New landmark**. To make a positioning request for the coordinates of your location, select **Current position**. To enter the position information manually, select **Enter manually**.

To add a landmark to preset categories, select the landmark and **Options** > **Add to category**. Select the categories to which you want to add the landmark.

To send one or several landmarks to a compatible device, select **Options** > **Send**. Your received landmarks are placed in **Inbox** in Messaging.

■ GPS data

GPS data is designed to provide route guidance information to a selected destination, position information about your location, and travelling information, such as the approximate distance and travel time to the destination.

Route guidance

Start the route guidance outdoors. Select  > **Applications** > **GPS data** > **Navigation**.

Route guidance shows the straightest route and the shortest distance to the destination, measured in a straight line. Any obstacles on the route, such as buildings and natural obstacles, are ignored. Differences in altitude are not taken into account when calculating the distance. Route guidance is active only when you move.

To set your trip destination, select **Options** > **Set destination** and a landmark as the destination, or enter the latitude and longitude coordinates. To clear the destination, select **Stop navigation**.

Position

To save your location as a landmark, select  > *Applications* > *GPS data* > *Position* > *Options* > *Save position*.

Trip meter

To activate trip distance calculation, select  > *Applications* > *GPS data* > *Trip distance* > *Options* > *Start*. To deactivate it, select *Options* > *Stop*. The calculated values remain on the display.

To set the trip distance and time and average and maximum speeds to zero, and to start a new calculation, select *Reset*. To set the odometer and total time to zero, select *Restart*.

The trip meter has limited accuracy, and rounding errors may occur. Accuracy can also be affected by availability and quality of GPS signals.

8. Gallery

■ Main view

To save and organise your images, video clips, music tracks, sound clips, playlists, streaming links, .ram files, and presentations, select  > *Gallery*.

To copy or move files to device memory or to the memory card, select a folder (such as *Images*), scroll to a file (or press # to mark several files), and select *Options* > *Organise* and the memory to where you want to copy or move the files.

To create new image and video clips folders, select *Images* or *Video clips* > *Options* > *Organise* > *New folder* and the memory. Enter a name for the folder. To move images and video clips to a folder you created, mark the files, and select *Options* > *Organise* > *Move to folder* and the folder.

To set an image as the wallpaper or to be shown during a call, select *Images*, and scroll to the image. Select *Options* > *Use image* > *Set as wallpaper* or *Set as call image*. To assign the image to a contact, select *Assign to contact*.

To set a video clips as a video ringing tone, select *Video clips* and the video. Select *Options* > *Use video* > *As ringing tone*. To assign the video clips for a contact, select *Assign to contact*.

■ Download files

To download images or video clips, select  > [Gallery](#) > [Images](#) or [Video clips](#) and the image icon ([Dwnl. imgs.](#)) or the video icon ([Downld. videos](#)). The browser opens. Choose a bookmark for the site to download from.

■ View images

To view images in Gallery, scroll to the image, select [Open](#).

To open the toolbar when viewing an image, press the scroll key.

To zoom in or out when viewing an image, press * or #.

■ Edit images

To open the image editor in Gallery, scroll to the image, select [Options](#) > [Edit](#).

To view an image in the full screen, and to return to the normal view, press *.

To rotate an image clockwise or counterclockwise, press 3 or 1.

To zoom in or out, press 5 or 0.

To move on a zoomed image, scroll up, down, left, or right.

To crop or rotate the image; adjust the brightness, colour, contrast, and resolution; and add effects, text, clip art, or a frame to the image, select [Options](#) > [Apply effect](#).

■ Edit video clips

To edit video clips in [Gallery](#) and create custom video clips, scroll to a video clip, and select [Options](#) > [Video editor](#) > [Options](#) > [Edit video clip](#).

In the video editor, you can see two timelines: video clip timeline and sound clip timeline. The images, text, and transitions added to a video clip are shown on the video clip timeline. To switch between the timelines, scroll up or down.

■ Print images

You can use the device with a PictBridge-compatible printer using a USB cable.

To print images in Gallery, scroll to the image, and select [Options](#) > [Print](#).

■ Share online

With the Share online application, you can share the images and video clips you have captured in compatible online albums, weblogs, or other compatible online sharing services on the web. You can upload content, save unfinished posts as

drafts and continue later, and view the content of the albums. The supported content types may vary depending on the online sharing service provider.

To share images and video clips online, you must have an account with an online image sharing service. You can usually subscribe to such a service on the web page of your service provider. For more information and applicable terms and costs, contact your service provider.

Select [☰](#) > [Internet](#) > [Share online](#). To update the list of service providers, select [Options](#) > [Add new account](#) > [Update services](#). Some online sharing service providers may allow you to add an account using your device. See "Share online settings," p. 44.

Upload files

To upload files, select [☰](#) > [Gallery](#) > [Images](#) or [Video clips](#). Mark the files to upload, and select [Options](#) > [Send](#) > [Post to web](#) and a sharing service.

When you select the service, the selected images and video clips are shown in the edit state. You can open and view the files, reorganise them, add text to them, or add new files.

To cancel the web upload process and save the created post as a draft, select [Cancel](#) > [Save as draft](#).

To connect to the service and upload the files to the web, select [Options](#) > [Post to web](#).

Open online service

To view uploaded images and video clips in the online service, and draft and sent entries in your device, select [☰](#) > [Internet](#) > [Share online](#). To update a service, scroll to it, and select [Options](#) > [Update service](#).

Select [Options](#) and from the following:

[Go to ... webs](#). — to connect to the service and view the uploaded and draft albums in the web browser. The view may vary depending on the service provider.

[Outbox](#)— to view and edit the draft entries and upload them to the web

[New post](#) — to create a new entry

The available options may vary depending on the service provider.

Share online settings

To edit the share online settings, select [☰](#) > [Internet](#) > [Share online](#) > [Options](#) > [Settings](#) and from the following:

Service providers – to view the list of service providers

My accounts – to create a new account, select **Options** > *Add new account*. To edit an existing account, select an account and **Options** > *Edit*. You can enter the name for the account, and the user name and password for the account.

Application settings – to select the size for the images shown on the display, and the font size used in drafts or text entries

Advanced – to select the default access point and the way for polling new content from the server. You can also enable content to be downloaded while roaming or all image data to be published.

9. Camera

Your device has two cameras to capture still images and record video clips. A high resolution main camera is on the back of the device using the landscape mode, and a lower resolution secondary camera is on the front using the portrait mode.

Your device supports an image capture resolution of 2048x1536 pixels using the main camera. The image resolution in this guide may appear different.

Keep a safe distance when using the flash. Do not use the flash on people or animals at close range. Do not cover the flash while taking a picture.

You can send images and video clips in a multimedia message, as an e-mail attachment, or by using Bluetooth connectivity. You can also upload them to a compatible online album. See "Share online," p. 43.

■ Capture images

Main camera

1. To activate the camera, press the camera key.
2. To zoom in or out, press the volume keys.
3. To lock the focus on an object, press the camera key halfway down.

To capture an image, press the camera key down.

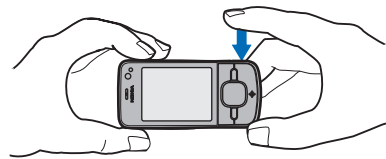

Secondary camera

1. To activate the secondary camera, press the camera key, scroll left or right to open the toolbar, and select **2**.

2. To zoom in or out, scroll up or down.
3. To capture an image, select **Capture**.

Close the camera

To close the camera, select **Options** > **Exit**.

If you open the Gallery from the camera, the camera is closed.

■ Record video clips

1. To activate the main camera, press the camera key. To activate the secondary camera, scroll left or right to open the toolbar, and select **2**. If the camera is in the image mode (📷), scroll left or right to open the toolbar, and select **📷**.
2. To start recording with the main camera, press the camera key. To start recording with the secondary camera, select **Record**. A tone sounds, indicating that recording has started.

To zoom in or out of the subject using the main camera, press the volume keys, or, using the secondary camera, scroll down or up.
3. To stop recording with the main camera, press the camera key. To stop recording with the secondary camera, select **Stop**. The video clip is automatically saved to the Video clips folder in the Gallery. See "Gallery," p. 42. The maximum length of the video clip depends on the available memory.

To pause recording at any time, select **Pause**. Video recording automatically stops if recording is paused and there are no keypresses within a minute. To resume recording, select **Continue**.

■ Capture panoramic images

To activate the panorama mode with the main camera, scroll left or right to activate the toolbar, and select **📷**.

To start capturing a panoramic image, press the camera key, and turn the camera slowly left or right. The camera captures the panoramic image and displays it as you turn. If the arrow on the viewfinder turns red, you are turning too fast and the image gets blurry. You cannot change the direction while turning. To stop capturing the image, press the camera key.

10. Media

■ Music player



Warning: Listen to music at a moderate level. Continuous exposure to high volume may damage your hearing. Do not hold the device near your ear when the loudspeaker is in use, because the volume may be extremely loud.

You can listen to music and podcast episodes also when the Offline profile is activated. See "Offline profile," p. 14.

For more information about copyright protection, see "Licences," p. 64.

Listen to music or a podcast episode

1. Select  > [Applications](#) > [Music player](#).
2. Select a category, such as [All songs](#) or [Podcasts](#) > [All episodes](#), and a song or a podcast episode.
3. To play the selected file, press the scroll key.

To pause, press the scroll key. To resume the playback, press the scroll key again.

4. To stop the playback, scroll down.

To fast forward or rewind, press and hold the scroll key right or left.

To skip forward, scroll right. To return to the beginning of the song or podcast, scroll left.

To skip to the previous song or podcast, scroll left again within 2 seconds after a song or podcast has started.

To adjust the volume, use the volume keys.

To return to the standby mode and leave the player in the background, press the end key. Depending on the selected standby theme, the currently playing song is displayed. To return to the music player, select the currently playing song.

Music menu

Select  > [Applications](#) > [Music player](#). The music menu shows the available music. To view all songs, sorted songs, or playlists, select the desired list in the music menu.

Playlists

Select  > [Applications](#) > [Music player](#) > [Playlists](#). To view details of a playlist, scroll to the playlist, and select [Options](#) > [Playlist details](#).

Create a playlist

1. Select [Options](#) > [Create playlist](#).
2. Enter a name for the playlist, and select **OK**.
3. To add songs now, select **Yes**. To add songs later, select **No**.
4. Select artists to find the songs you want to include in the playlist. To add a song, press the scroll key.
5. When you have made your selections, select **Done**. If a compatible memory card is inserted, the playlist is saved to the memory card.

To add more songs later, when viewing the playlist, select [Options](#) > [Add songs](#).

Podcasts

To view all the podcast episodes available in your device, select  > [Applications](#) > [Music player](#) > [Podcasts](#) > [All episodes](#).

The podcast episodes have three states: never played, partially played, and completely played. If an episode is partially played, it plays from the last playback position the next time it is played. Otherwise, it is played from the beginning.

Nokia Music Store

In the Nokia Music Store (network service) you can search, browse, and purchase music for downloading to your device. To purchase music, you first need to register for the service. For availability of Nokia Music Store in your country, visit www.music.nokia.com.

To access the Nokia Music Store, you must have a valid internet access point in your device. To open Nokia Music Store, select  > [Applications](#) > [Music player](#) > [Options](#) > [Go to Music store](#).

Transfer music

You can buy music protected with WMDRM from online music shops and transfer the music to your device.

To refresh the library after you have updated the song selection in your device, select  > [Applications](#) > [Music player](#) > [Options](#) > [Refresh library](#).

Transfer music from PC

To synchronise music with Windows Media Player, connect the compatible USB cable and select *Media transfer* as the connection mode. You can transfer WMDRM protected music files only using media transfer. A compatible memory card needs to be inserted in the device.

To use Nokia Music Manager in Nokia PC Suite, see the Nokia PC Suite user guide.

■ Nokia Podcasting

With the Nokia Podcasting application (network service), you can search, discover, subscribe to, and download podcasts over the air, and play, manage, and share audio podcasts with your device.



Warning: Listen to music at a moderate level. Continuous exposure to high volume may damage your hearing. Do not hold the device near your ear when the loudspeaker is in use, because the volume may be extremely loud.

Settings

To use Nokia Podcasting, you must set your connection and download settings.

Setting the application to retrieve podcasts automatically may involve the transmission of large amounts of data through your service provider's network. Contact your service provider for information about data transmission charges.

Select  > *Applications* > *Podcasting* > *Options* > *Settings* and from the following:

Connection > *Default access point* – to select the access point to define your connection to the Internet. To define the podcast search service for searches, select *Search service URL*.

Download – to edit the download settings. You can select whether to save your podcasts to the device or the memory card; set how often podcasts are updated and set the time and date for the next automatic update; and set how much memory space to use for podcasts, and what to do if the downloads exceed the download limit.

Search

To set the search engine to use the podcast search service, select  > *Applications* > *Podcasting* > *Options* > *Settings* > *Connection* > *Search service URL*.

To search for podcasts, select  > *Applications* > *Podcasting* > *Search*, and enter a keyword or a title.

To subscribe to a channel and add it to your podcasts, select [Options](#) > [Subscribe](#). You can also mark channels to add them all at the same time.

Directories

Directories help you to find new podcast episodes to which to subscribe. An episode is a particular media file of a podcast.

Select [⌘](#) > [Applications](#) > [Podcasting](#) > [Directories](#). Select a directory folder to update it (network service). When the colour of the folder icon changes, select to open it, and select a folder topic to view the list of podcasts.

To subscribe to a podcast, select the title. After you have subscribed to episodes of a podcast, you can download, manage, and play them in the podcasts menu.

To add a new directory or folder, select [Options](#) > [New](#) > [Web directory](#) or [Folder](#). Select a title, URL of the .opml (outline processor markup language) file, and [Done](#).

To import an .opml file saved in your device, select [Options](#) > [Import OPML file](#). Select the location of the file, and import it.

When you receive a message with an .opml file using Bluetooth connectivity, open the file and save it to the [Received](#) folder in Directories. Open the folder to subscribe to any of the links to add to your podcasts.

Downloads

To view the podcasts you have subscribed to, select [⌘](#) > [Applications](#) > [Podcasting](#) > [Podcasts](#). To view individual episode titles, select the podcast title.

To start a download, select the episode title. To download or to continue to download selected or marked episodes, select [Options](#) > [Download](#) or [Continue download](#). You can download multiple episodes at the same time.

To play a portion of a podcast during download or after partial downloading, select [Podcasts](#) and the podcast, scroll to the episode being downloaded, and select [Options](#) > [Play preview](#).

Fully downloaded podcasts are saved in the Podcasts folder in Music player when the music library is refreshed.

Play and manage podcasts

To display the episodes from a podcast, open the podcast. Under each episode, you can see the file information.

To play a fully downloaded episode, select [⌘](#) > [Applications](#) > [Music player](#) > [Podcasts](#).

To update the selected podcast or marked podcasts, for a new episode, select **Options** > *Update*.

To add a new podcast by entering the URL of the podcast, select **Options** > *New podcast*. To edit the URL of a selected podcast, select *Edit*.

To update, delete, and send a group of selected podcasts at once, select **Options** > *Mark/Unmark*, mark the podcasts, and select **Options** and the desired action.

To open the website of the podcast (network service), select **Options** > *Open web page*.

Some podcasts provide the opportunity to interact with the creators by commenting and voting. To connect to the internet to do this, select **Options** > *View comments*.

■ Radio

To turn on the radio, select  > **Applications** > *Radio*. To turn the radio off, select *Exit*.

When you turn on the radio for the first time, a wizard helps you to save local radio stations (network service).

For availability and costs of the visual service and station directory services, contact your service provider.

The FM radio depends on an antenna other than the wireless device antenna. A compatible headset or enhancement needs to be attached to the device for the FM radio to function properly.



Warning: Listen to music at a moderate level. Continuous exposure to high volume may damage your hearing. Do not hold the device near your ear when the loudspeaker is in use, because the volume may be extremely loud.

The radio supports Radio Data System (RDS) functionality. Radio stations supporting RDS may display information, such as the name of the station. If activated in the settings, RDS also attempts to scan for an alternative frequency for the currently playing station, if the reception is weak. To set your device automatically search for alternative frequencies, select **Options** > *Settings* > *Alternative frequencies* > *Auto scan on*.

Tune and save a radio station

To start the station search when the radio is on, scroll up or down. To save the station when a station is found, select **Options** > *Save station*. Select a location for the station, enter the name for it, and select **OK**.

To view the list of saved stations, select **Options** > **Stations**. To change the settings of a station, select the station and **Edit**.

Radio functions

To adjust the volume, press the volume keys.

If there are any saved stations, scroll right or left to the next or previous stations.

You can make or answer a call while listening to the radio. The radio is muted when there is an active call.

To listen to the radio in the background and go to the standby mode, select **Options** > **Play in background**.

View visual content

For availability and costs, and to subscribe to the service, contact your service provider.

To view visual content of the current station, select **Options** > **Start visual service**. Station needs to have visual service ID saved before service can be used.

To end the visual content feed but continue listening to the radio, select **Close**.

Station directory

To access the station directory (network service), select **Options** > **Station directory** and your location. Radio stations that provide visual content are indicated with . To listen to or save a station, scroll to it, and select **Options** > **Listen** or **Save**.

■ RealPlayer

With RealPlayer, you can play media files such as video clips saved in the device memory or memory card, or stream media files over the air by opening a streaming link. RealPlayer does not support all file formats or all the variations of file formats.

Select  > **Applications** > **RealPlayer**. To play, select **Video clips**, **Streaming links**, or **Recently played** and a media file or a streaming link.

To stream live content, you must first configure your default access point. Select  > **Applications** > **RealPlayer** > **Options** > **Settings** > **Streaming** > **Network**. For more information, contact your service provider.





Warning: Do not hold the device near your ear when the loudspeaker is in use, because the volume may be extremely loud.

■ Flash Player

To view, play, and interact with flash files made for mobile devices, select  > [Applications](#) > [Flash Player](#). To open a folder or play a flash file, select it.

■ Recorder

With voice recorder, you can record voice call conversations and voice memos. If you record a phone conversation, all parties hear a beeping sound during recording.

Select  > [Applications](#) > [Recorder](#). To record a sound clip, select [Options](#) > [Record sound clip](#), or select . To listen to the recording, select . Recorded files are saved in the Sound clips folder in Gallery.

11. Internet

■ Browse the web

To browse web pages, select  > [Internet](#) > [Web](#), or press and hold 0 in the standby mode.

For availability of services, pricing, and tariffs, contact your service provider.



Important: Use only services that you trust and that offer adequate security and protection against harmful software.

To access web pages, do one of the following:

- Select a bookmark from the bookmarks view.
- In the bookmarks view, enter the address of the web page, and select [Go to](#).

Bookmarks

To add a bookmark manually, in the bookmarks view, select [Options](#) > [Bookmark manager](#) > [Add bookmark](#), fill in the fields, and select [Options](#) > [Save](#).

Connection security

If the security indicator  is displayed during a connection, the data transmission between the device and the internet gateway or server is encrypted.

The security icon does not indicate that the data transmission between the gateway and the content server (or place where the requested resource is stored) is secure. The service provider secures the data transmission between the gateway and the content server.

To view details about the connection, encryption status, and information about server authentication, select [Options](#) > [Tools](#) > [Page info](#).

Keys and commands for browsing

To open a link, make selections, or check boxes, press the scroll key.

To go to the previous page while browsing, select **Back**. If **Back** is not available, to view a chronological list of the pages visited during a browsing session, select **Options** > **Navigation options** > **History**. Scroll left or right, and select the desired page. The history list is cleared each time a session is closed.

To save a bookmark while browsing, select **Options** > **Save as bookmark**.

To retrieve the latest content from the server, select **Options** > **Navigation options** > **Reload**.

To open the browser toolbar, scroll to an empty part of the page, and press and hold the scroll key.

To end the connection and view the browser page offline, select **Options** > **Tools** > **Disconnect**. To stop browsing, select **Options** > **Exit**.

Keypad shortcuts while browsing

- 1 – Open your bookmarks.
- 2 – Search for keywords in the current page.
- 3 – Return to the previous page.
- 5 – List all open windows.
- 8 – Show the page overview of the current page. Press **8** again to zoom in and view the desired section of the page.
- 9 – Enter a new web address.
- 0 – Go to the start page.
- * or # – Zoom the page in or out.

Mini map

Mini map helps you navigate web pages that contain large amount of information. When Mini map is on in the browser settings and you scroll through a large web page, Mini map opens and displays an overview of the web page you are browsing. To move in Mini map, scroll. When you stop scrolling, Mini map disappears and the area outlined in Mini map is displayed.

Page overview

With Page overview, you can move more quickly to the desired part of a web page. Page overview may not be available on all pages.

To show the page overview of the current page, press **8**. To find the desired spot on the page, scroll up or down. Press **8** again to zoom in and view the desired section of the page.

Web feeds

Web feeds are widely used to share the latest headlines or recent news.

The browser automatically detects if a web page contains web feeds. To subscribe to a web feed, select **Options** > [Subscribe to web feeds](#) and a feed, or click on the link. To view the web feeds you have subscribed to, in the bookmarks view, select [Web feeds](#).

To update a web feed, select it, and **Options** > [Refresh](#).

To define how the web feeds are updated, select **Options** > [Settings](#) > [Web feeds](#).

Widgets

Your device supports widgets. Widgets are small, downloadable web applications that deliver multimedia, news feeds, and other information, such as weather reports, to your device. Installed widgets appear as separate applications in the My own folder in Applications.

You can download widgets using the Download! application or from the web.

The default access point for widgets is the same as in the web browser. When active in the background, some widgets may update information automatically to your device. Using widgets may involve the transmission of large amounts of data through your service provider's network. Contact your service provider for information about data transmission charges.

Saved pages

To save a page while browsing to be able to view it offline, select **Options** > [Tools](#) > [Save page](#).

To view saved pages, in the bookmarks view, select [Saved pages](#). To open a page, select it.

Clear privacy data

A cache is a memory location that is used to store data temporarily. If you have tried to access or have accessed confidential information requiring passwords, empty the cache after each use. The information or services you have accessed are stored in the cache. To empty the cache, select **Options** > [Clear privacy data](#) > [Cache](#).

To clear all privacy data, select **Options** > [Clear privacy data](#) > [All](#).

■ Search

Use Search to get access to search engines, and find and connect to local services, websites, images, and mobile content (network service). For example, you can use the application to find local restaurants and shops. You can also search for data in your device and memory card.

Select  > [Internet](#) > [Search](#).

12. Personalisation

■ Themes

To change the look of your device display, activate a theme.

Select  > [Settings](#) > [Themes](#). To view the available themes, select [General](#). The active theme is indicated by a check mark.

To preview a theme, scroll to the theme, and select [Options](#) > [Preview](#). To activate the previewed theme, select [Set](#).

In Themes, you can also set the menu view type, set a theme for the standby mode, set a custom wallpaper, personalise the look of the power saver, and select an image shown during a call.

■ Profiles

In Profiles, you can adjust and personalise the device tones for different events, environments, or caller groups. You can see the selected profile at the top of the display in the standby mode. If the General profile is in use, only the current date is shown.

Select  > [Settings](#) > [Profiles](#).

To activate the profile, select the profile and [Activate](#).



Tip: To quickly change to silent profile from any other profile, in the standby mode, press and hold #.

To personalise a profile, select the profile, [Personalise](#), and the desired settings.

To set the profile to be active until a certain time within the next 24 hours, select [Timed](#) and the time.

See also "Offline profile," p. 14.

13. Time management

■ Clock

Select **⌘** > *Office* > *Clock*. To change the clock settings, and to set the time and date, select **Options** > *Settings*.

To set the device to show the time in other locations, scroll right to *World clock*. To add a location, select **Options** > *Add location*.

To set your current location, scroll to a location, and select **Options** > *Set as current location*. The location is displayed in the clock main view, and the time in your device is changed according to the location selected. Check that the time is correct and matches your time zone.

Alarm clock

To set a new alarm, scroll right to *Alarms*, and select **Options** > *New alarm*. Enter the alarm time, select whether and when the alarm is repeated, and select **Done**.

■ Calendar

Select **⌘** > *Office* > *Calendar*. Press # in month, week, or day views to automatically highlight the current date.

To add a new calendar entry, select **Options** > *New entry* and an entry type. *Anniversary* entries are repeated every year. *To-do* entries help you to keep a list of tasks that you need to do. Fill in the fields, and select **Done**.

14. Office applications

■ Active notes

Active notes allows you to create, edit, and view different kinds of notes. You can insert images and videos or sound clips in the notes, link notes to other applications, such as Contacts, and send notes to others.

Select **⌘** > *Office* > *Active notes*.

To create a note, start writing. To insert images, sound or video clips, business cards, web bookmarks, or files, select **Options** > *Insert object* and the type of item.

To set the device to show a note when making or receiving a call from a contact, select **Options** > *Settings*. To link a note to a contact, open the note, and select **Options** > *Link note to call* > *Add contacts* and the contact.

■ Notes

Select  > [Office](#) > [Notes](#).

To write a new note, start writing. To save the note, select [Done](#).

You can save plain text files (.txt format) you receive to Notes.

■ Calculator

Select  > [Office](#) > [Calculator](#). When entering numbers, to add a decimal point, press #.



Note: This calculator has limited accuracy and is designed for simple calculations.

■ Converter

Select  > [Office](#) > [Converter](#). You can convert measurements, such as length from one unit to another, for example, from yards to metres.

The converter has limited accuracy and rounding errors may occur.

Before you can convert currency, you need to choose a base currency (usually your domestic currency) and add exchange rates. The rate of the base currency is always 1. Select [Currency](#) as the measurement type, and select [Options](#) > [Currency rates](#). To change the base currency, scroll to the currency, and select [Options](#) > [Set as base currency](#). To add exchange rates, scroll to the currency, and enter a new rate.

After you insert all the required exchange rates, you can convert currency. In the first amount field, enter the value to be converted. The other amount field changes automatically.



Note: When you change base currency, you must enter new exchange rates because all previously set exchange rates are cleared.

■ Mobile dictionary

Use Dictionary to translate words from one language to another.

Select  > [Office](#) > [Dictionary](#). English is available by default in your device. You can add two more languages. To add a language, select [Options](#) > [Languages](#) > [Download languages](#). You can remove languages except English and add new ones. The languages are free of charge, but downloading may involve the transmission of large amounts of data through your service provider's network. Contact your service provider for information about data transmission charges.

The display shows abbreviations for source and target languages. To change the source and target language, select **Options** > *Languages* > *Source* and *Target*.

Enter the word to be translated, and select **Translate**. To hear the word spoken, select **Listen**.

■ Adobe Reader

Use *Adobe Reader* to view portable document format (.pdf) documents. To open the application, select  > *Office* > *Adobe PDF*.

Open a .pdf file

To open a recently viewed document, select it. To open a document that is not listed in the main view, select **Options** > *Browse for file*, the memory and folder where the file is stored and the file.

View a document

To move around within a page, scroll. To move to the next page, scroll down at the bottom of the page.

To zoom in or out, select **Options** > *Zoom* > *In* or *Out*.

To find text, select **Options** > *Find* > *Text*, and enter the text you want to find. To find the next occurrence, select **Options** > *Find* > *Next*.

To save a copy of the document, select **Options** > *Save*.

■ Quickoffice

To use the Quickoffice applications, select  > *Office* > *Quickoffice*.

Not all variations or features of Word, Excel, and PowerPoint file formats are supported.

If you experience problems with the Quickoffice applications, see www.quickoffice.com, or send an e-mail to supportS60@quickoffice.com.

Quickmanager

With Quickmanager, you can download software, including updates, upgrades, and other useful applications. You can pay for the downloads in your phone bill or using a credit card.

15. Settings

■ Voice commands

To select the functions to use by voice command, select  > *Settings* > *Voice comm.*. The voice commands for changing profiles are in the Profiles folder.

To change the voice command for an application, scroll to the application, and select *Edit*, or *Options* > *Change command*. To play the activated voice command, select *Options* > *Playback*.

To use voice commands, see "Voice dialling," p. 21.

■ Phone settings

General

Select  > *Settings* > *Phone sett.* > *General* and from the following:

Personalisation – to adjust the display, standby mode, tones (such as ringing tone), language, themes, and voice command settings

Date and time – to set the time and date and the display format

Enhancement – to change the settings for an enhancement. Select an enhancement and the desired setting.

Slide handling – to edit the slide settings. See "Keypad lock (keyguard)," p. 17, "Make a voice call," p. 20, and "Answer or reject a call," p. 22.

Sensor settings – to set which functions the accelerometer controls in your device and activate specific sensor interactions. See "Motion sensor," p. 17.

Security – to change the device and SIM card settings, such as PIN and lock codes; view certificate details and check authenticity; and view and edit security modules

When security features that restrict calls are in use (such as call barring, closed user group, and fixed dialling), calls may be possible to the official emergency number programmed into your device.

Factory settings – to reset some of the settings to their original values. You need the lock code.

Positioning (network service) – to change positioning settings. See "Positioning settings," p. 34.

Phone

See "Call settings," p. 23.

Connection

Select  > *Settings* > *Phone sett.* > *Connection* and from the following:

Bluetooth — to switch Bluetooth technology on or off, and edit Bluetooth settings. See "Bluetooth connection settings," p. 68.

USB — to edit USB settings. See "USB connection," p. 69.

Destinations — to define the connection methods used for reaching a particular destination

Packet data — to select the packet data connection settings. The packet data settings affect all access points using a packet data connection.

- To set the device to register to the packet data network when you are in a network that supports packet data, select *Packet data connection* > *When available*. If you select *When needed*, the device uses a packet data connection only if you start an application or function that needs it.
- To set the access point name to use your device as a modem with your computer, select *Access point*.
- To enable the use of HSDPA (network service) in UMTS networks, select *High speed packet access*. When HSDPA support is activated, downloading data such as messages, e-mail, and browser pages through the cellular network may be faster.

Data call — to set the online time for the data call connection. The data call settings affect all access points that use a GSM data call.

Video sharing — to set your SIP profile settings manually. See "Video sharing settings," p. 25.

Presence (network service) — to view and edit the presence settings. Connection applications, such as push to talk, use the presence settings. You may receive the settings from your service provider.

SIP settings — to view and edit session initiation protocol (SIP) profiles. See "Video sharing," p. 25.

XDM profile — to create or edit an XDM profile. Settings are for communication applications, such as presence and push to talk. These enable the service provider to access some user information that is saved in the network servers but managed

by the user, for example push to talk groups. You may receive the settings from your service provider. See "Configuration settings," p. 11.

Configurations – to view and delete configuration contexts. Certain functions, such as web browsing and multimedia messaging, may require configuration settings. You may receive the settings from your service provider. See "Configuration settings," p. 11.

APN control – to restrict the use of packet data access points. This setting is only available if your SIM card supports the service. To change the settings, you need the PIN2 code.

Applications

To view and edit settings of applications installed to your device, select  > **Settings** > **Phone sett.** > **Applications**.

■ Speech

In Speech, you can select the default language and voice used for reading text messages and adjust the voice properties, such as rate and volume. Select  > **Settings** > **Speech**.

To view details of a voice, scroll right, scroll to the voice, and select **Options** > **Voice details**. To test a voice, scroll to the voice, and select **Options** > **Play voice**.

16. Data management

■ Install or remove applications

You can install two types of applications to your device:

- J2ME™ applications based on Java™ technology with the extension .jad or .jar. PersonalJava™ applications cannot be installed to your device.
- Other applications and software suitable for the Symbian operating system. The installation files have the .sis or .six extension. Only install software specifically designed for your device.



Important: Only install and use applications and other software from trusted sources, such as applications that are Symbian Signed or have passed the Java Verified™ testing.

Installation files may be transferred to your device from a compatible computer, downloaded during browsing, or sent to you in a multimedia message, as an e-mail attachment or by using Bluetooth technology. You can use Nokia

Application Installer in Nokia PC Suite to install an application to your device or a memory card.

To find installed applications, select  > *Applications* > *My own*.

To open Application manager, select  > *Settings* > *Data mgr.* > *App. mgr.*

Install an application

The .jar file is required for installing Java applications. If it is missing, the device may ask you to download it.

1. To install an application or software package, select *Installation files*, and scroll to an installation file. Applications on the memory card are indicated with .
2. Select *Options* > *Install*.

Alternatively, search the device memory or the memory card, select the application, and press the scroll key to start the installation.

During the installation, the device shows information about the progress of the installation. If you are installing an application without a digital signature or certification, the device displays a warning. Continue installation only if you are sure of the origins and contents of the application.



Important: Even if the use of certificates makes the risks involved in remote connections and software installation considerably smaller, they must be used correctly in order to benefit from increased security. The existence of a certificate does not offer any protection by itself; the certificate manager must contain correct, authentic, or trusted certificates for increased security to be available. Certificates have a restricted lifetime. If "Expired certificate" or "Certificate not valid yet" is shown, even if the certificate should be valid, check that the current date and time in your device are correct.

Before changing any certificate settings, you must make sure that you really trust the owner of the certificate and that the certificate really belongs to the listed owner.

Java applications may attempt to, for example, establish a data connection or send a message. To edit the permissions of an installed Java application and define which access point the application will use, select *Installed apps*, scroll to the application, and select *Open*.

After you install applications to a compatible memory card, installation files (.sis) remain in the device memory. The files may use large amounts of memory and prevent you from storing other files. To maintain sufficient memory, use Nokia PC Suite to back up installation files to a compatible PC, then use the file manager to remove the installation files from the

device memory. See "File manager," p. 64. If the .sis file is a message attachment, delete the message from the Messaging inbox.

Remove an application

In the Application manager main view, select *Installed apps*, scroll to the software package, and select **Options** > *Uninstall*.

■ File manager

To browse, open, and manage files and folders in the device memory or on a memory card, select  > *Office* > *File mgr.*

Back up and restore device memory

To back up information from device memory to the memory card or restore information from the memory card, in File manager, select **Options** > *Back up phone memory* or *Restore from mem. card*. You can only back up the device memory and restore it to the same device.

Format a memory card

When a memory card is formatted, all data on the card is permanently lost. Some memory cards are supplied preformatted and others require formatting.

1. In the File manager view, select the memory card.
2. Select **Options** > *Memory card options* > *Format*.
3. When formatting is complete, enter a name for the memory card.

Lock or unlock a memory card

To set a password to help prevent unauthorised use, in the File manager view, select the memory card and **Options** > *Memory card password* > *Set*. Enter and confirm your password. The password can be up to eight characters long.

If you insert another password-protected memory card into your device, you are prompted to enter the password of the card. To unlock the card, select **Options** > *Unlock memory card*.

■ Licences

Digital rights management

Content owners may use different types of digital rights management (DRM) technologies to protect their intellectual property, including copyrights. This device uses various types of DRM software to access DRM-protected content. With this device you can access content protected with WMDRM, OMA DRM 1.0, and OMA DRM 2.0. If certain DRM software fails to

protect the content, content owners may ask that such DRM software's ability to access new DRM-protected content be revoked. Revocation may also prevent renewal of such DRM-protected content already in your device. Revocation of such DRM software does not affect the use of content protected with other types of DRM or the use of non-DRM-protected content.

Digital rights management (DRM) protected content comes with an associated activation key that defines your rights to use the content.

If your device has OMA DRM-protected content, to back up both the licences and the content, use the backup feature of Nokia PC Suite. Other transfer methods may not transfer the licences which need to be restored with the content for you to be able to continue the use of OMA DRM protected content after the device memory is formatted. You may also need to restore the licences in case the files on your device get corrupted.

If your device has WMDRM protected content, both the licences and the content will be lost if the device memory is formatted. You may also lose the licences and the content if the files on your device get corrupted. Losing the licences or the content may limit your ability to use the same content on your device again. For more information, contact your service provider.

Some licences may be connected to a specific SIM card, and the protected content can be accessed only if the SIM card is inserted in the device.

To view the licences saved in your device, select  > [Settings](#) > [Data mgr.](#) > [Licences](#).

To view valid licences that are connected to one or more media files, select [Valid licences](#). Group licences, which contain several licences, are indicated with . To view the licences contained in the group licence, select the group licence.

To view invalid licences for which the time period for using the file has exceeded, select [Invalid licences](#). To buy more usage time or extend the usage period for a media file, select an invalid licence and [Options](#) > [Get new licence](#). It may not be possible to update licences if service message reception is disabled.

To view licences that are not in use, select [Not in use](#). Unused licences have no media files connected to them.

To view detailed information such as the validity status and the ability to send the file, scroll to a licence, and select it.

■ Device manager

With device manager you can connect to a server and receive configuration settings for your device, create new server profiles, or view and manage existing server profiles. You may receive configuration settings from your service provider or company information management department.

To open the device manager, select  > [Settings](#) > [Data mgr.](#) > [Device mgr.](#)

Update software



Warning: If you install a software update, you cannot use the device, even to make emergency calls, until the installation is completed and the device is restarted. Be sure to back up data before accepting installation of an update.

Downloading software updates may involve the transmission of large amounts of data through your service provider's network. Contact your service provider for information about data transmission charges.

Make sure that the device battery has enough power, or connect the charger before starting the update.

1. Select [Options](#) > [Check for updates](#). If an update is available, accept to download it.
2. After a successful download, to install the update, select [Now](#). To start the installation later, select [Later](#).

To start the installation process later, select [Options](#) > [Install update](#).

If no server profile has been defined, the device asks you to create one, or if there are several, to select from a list of servers. For server profile settings, contact your service provider.

Configure your device

You may receive configuration settings from your service provider or company information management department.

To connect to a server and receive configuration settings for your device, select [Options](#) > [Server profiles](#), scroll to the server profile, and select [Options](#) > [Start configuration](#).

To edit a server profile, scroll to the profile, and select [Options](#) > [Edit profile](#).

For the server profile settings, contact your service provider or company information management department.

17. Connectivity

■ Transfer or synchronise data

With Phone switch, you can copy or synchronise contacts, calendar entries, and possibly other data, such as video clips and images, from a compatible device using a Bluetooth connection.

Depending on the other device, synchronisation may not be possible and data can be copied only once.

1. To transfer or synchronise data, select  > *Settings* > *Connectivity* > *Switch*.

If you have not used Phone switch before, information about the application is displayed. To start transferring data, select *Continue*.

If you have used Phone switch, select the icon *Start sync*, *Start retrieving* or *Start sending*.

2. When using Bluetooth technology, the devices need to be paired to transfer data.

Depending on the type of the other device, an application may be sent and installed on the other device to enable the data transfer. Follow the instructions on the display.

3. Select what content you want to transfer to your device.
4. Content is transferred to your device. The transfer time depends on the amount of data. You can stop the transfer and continue later.

■ PC Suite

With PC Suite you can synchronise contacts, calendar entries, and notes between your device and a compatible PC.

You may find more information about PC Suite and the download link in the support area on the Nokia website, www.nokia.com/pcsuite.

■ Bluetooth connectivity

Bluetooth wireless technology enables wireless connections between electronic devices within a maximum range of 10 metres (33 feet).

This device is compliant with Bluetooth Specification 2.0 supporting the following profiles: Advanced Audio Distribution, Audio/Video Remote Control, Basic Imaging, Dial-Up Networking, File Transfer, Hands-free, Headset, Object Push, Serial Port, Phone Book Access, SIM Access, Generic Audio/Video Distribution, Generic Access, and Generic Object Exchange. To ensure interoperability between other devices supporting Bluetooth technology, use Nokia approved enhancements for this model. Check with the manufacturers of other devices to determine their compatibility with this device.

Features using Bluetooth technology, or allowing such features to run in the background while using other features, increase the demand on battery power and reduce the battery life.

Do not accept Bluetooth connections from sources you do not trust.

A Bluetooth connection is disconnected automatically after sending or receiving data.

Bluetooth connection settings

Select  > *Settings* > *Connectivity* > *Bluetooth*.

Bluetooth – to switch Bluetooth connectivity on or off

My phone's visibility – to allow your device to be found by other devices with Bluetooth connectivity at all times, select *Shown to all*. To allow your device to be found for a defined time period, select *Define period*. For security reasons it is advisable to use the *Hidden* setting whenever possible.

My phone's name – to define a name for your device

Remote SIM mode – to enable another device, for example, a car kit, to use the SIM card of your device using Bluetooth technology (SIM access profile)

When the wireless device is in the remote SIM mode, you can only use a compatible connected enhancement, such as a car kit, to make or receive calls. Your wireless device will not make any calls, except to the emergency numbers programmed into your device, while in this mode. To make calls from your device, you must first leave the remote SIM mode. If the device has been locked, enter the lock code to unlock it first.

Send data

1. Open the application where the item you want to send is saved.
2. Scroll to the item you want to send, and select *Options* > *Send* > *Via Bluetooth*.
3. The device starts to search for devices within range. Paired devices are shown with . Some devices may show only the unique device addresses. To find out the unique address of your device, enter the code **#2820#* in the standby mode.
If you have searched for devices earlier, a list of devices found previously is shown. To start a new search, select *More devices*.
4. Select the device with which you want to connect.
5. If the other device requires pairing before data can be transmitted, a tone sounds and you are asked to enter a passcode. Create your own passcode and share the passcode with the owner of the other device. You do not have to memorise the passcode.

Pair and block devices

To open a list of paired devices, in the Bluetooth view, scroll right to *Paired devices*.

To pair with a device, select **Options** > *New paired device*, select the device with which to pair, and exchange passcodes.

To cancel pairing, scroll to the device whose pairing you want to cancel, and press the clear key. If you want to cancel all pairings, select **Options** > *Delete all*.

To set a device to be authorised, scroll to the device, and select **Options** > *Set as authorised*. Connections between your device and an authorised device can be made without your knowledge. Use this status only for your own devices to which others do not have access, for example, your PC or devices that belong to someone you trust.  is added next to authorised devices in the paired devices view.

To block connections from a device, in the paired devices view, select the device and *Block*.

To view a list of blocked devices, scroll right to *Blocked devices*. To unblock a device, scroll to the device, and select *Delete*.

Receive data

When you receive data using Bluetooth technology, you are asked if you want to accept the message. If you accept, the item is placed in inbox in Messaging.

■ USB connection

Connect the USB data cable to establish a data connection between the device and a compatible PC.

Select  > *Settings* > *Connectivity* > *USB* and from the following:

USB connection mode – to select the default USB connection mode or change the active mode. Select *PC Suite* to use the device with Nokia PC Suite; *Mass storage* to access files on the inserted memory card as a mass storage device; *Image transfer* to use the device with a PictBridge-compatible printer, or *Media transfer* to synchronise media files, such as music, with a compatible version of Windows Media Player.

Ask on connection – to set the device to ask the purpose of the connection each time the cable is connected, select *Yes*. To set the default mode to be activated automatically, select *No*.

After transferring data, ensure that it is safe to unplug the USB data cable from the PC.

■ Remote synchronisation

Sync enables you to synchronise data such as your calendar entries, contacts, and notes with a compatible computer or a remote internet server.

Select  > [Settings](#) > [Connectivity](#) > [Sync](#).

To create a new profile, select [Options](#) > [New sync profile](#) and enter the required settings.

To synchronise data, in the main view, mark the data to be synchronised, and select [Options](#) > [Synchronise](#).

■ Push to talk

Push to talk (PTT) (network service) is a real-time voice over IP service (network service). PTT provides direct voice communication connected with a single keypress. In PTT communication, one person talks while the others listen. The length of time of each turn is limited.

For availability, costs and subscription to the service, contact your service provider. Note that roaming services may be more limited than home network services.

Before you can use the PTT service, you must define the PTT connection settings. For PTT service settings, contact your service provider.

Phone calls always take priority over PTT calls.

Select  > [Applications](#) > [PTT](#).

Log in to PTT

To log in manually, select [Options](#) > [Log in to PTT](#).

 indicates a PTT connection.

 indicates that PTT is set to do not disturb (DND).

Exit PTT

Select [Options](#) > [Exit](#). [Log out from PTT after exiting application?](#) is displayed. To log out, select [Yes](#). To keep PTT active in the background, select [No](#).

Make a one-to-one call



Warning: Do not hold the device near your ear when the loudspeaker is in use, because the volume may be extremely loud.

1. Select [Options](#) > [PTT contacts](#) > [Contacts](#), scroll to the contact you want to talk to, and press the call key.

2. When the connection has been established, to talk to the other participant, press and hold the call key while you talk.
3. To end the PTT call, select **Disconnect**, or, if there are several PTT calls, select **Options** > **Disconnect**.

Make a PTT group call

To call a group, select **Options** > **PTT contacts** > **Contacts** > **Options** > **Talk to many**, mark the contacts you want to call, and select **OK**.

PTT sessions

PTT sessions are displayed as call bubbles in the PTT display, giving information about the status of the PTT sessions:

Wait – shown when you press and hold the call key and somebody else is still speaking in the PTT session

Talk – shown when you press and hold the call key and get the permission to speak

Send a callback request

To send a callback request from Contacts, scroll to a contact, and select **Options** > **Send callback request**.

■ Connection manager

In the Connection manager, you can identify the status of data connections, view details on the amount of data sent and received, and end unused connections.



Note: The actual invoice for calls and services from your service provider may vary, depending on network features, rounding off for billing, taxes, and so forth.

Select  > **Settings** > **Connectivity** > **Conn. mgr.**

To view connection details, scroll to a connection, and select **Options** > **Details**.

To end a connection, scroll to the connection, and select **Options** > **Disconnect**. To end all connections, select **Options** > **Disconnect all**.

18. Enhancements



Warning: Use only batteries, chargers, and enhancements approved by Nokia for use with this particular model. The use of any other types may invalidate any approval or warranty, and may be dangerous.

For availability of approved enhancements, please check with your dealer. When you disconnect the power cord of any enhancement, grasp and pull the plug, not the cord.

19. Battery and charger information

Your device is powered by a rechargeable battery. The battery intended for use with this device is BL-5F. This device is intended for use when supplied with power from the following chargers: AC-4, AC-5, AC-6, AC-8 or DC-4 chargers. The battery can be charged and discharged hundreds of times, but it will eventually wear out. When the talk and standby times are noticeably shorter than normal, replace the battery. Use only Nokia approved batteries, and recharge your battery only with Nokia approved chargers designated for this device. Use of an unapproved battery or charger may present a risk of fire, explosion, leakage, or other hazard.

If a battery is being used for the first time or if the battery has not been used for a prolonged period, it may be necessary to connect the charger, then disconnect and reconnect it to begin charging the battery. If the battery is completely discharged, it may take several minutes before the charging indicator appears on the display or before any calls can be made.

Always switch the device off and disconnect the charger before removing the battery.

Unplug the charger from the electrical plug and the device when not in use. Do not leave a fully charged battery connected to a charger, since overcharging may shorten its lifetime. If left unused, a fully charged battery will lose its charge over time.

Always try to keep the battery between 15°C and 25°C (59°F and 77°F). Extreme temperatures reduce the capacity and lifetime of the battery. A device with a hot or cold battery may not work temporarily. Battery performance is particularly limited in temperatures well below freezing.

Do not short-circuit the battery. Accidental short-circuiting can occur when a metallic object such as a coin, clip, or pen causes direct connection of the positive (+) and negative (-) terminals of the battery. (These look like metal strips on the battery.) This might happen, for example, when you carry a spare battery in your pocket or purse. Short-circuiting the terminals may damage the battery or the connecting object.

Do not dispose of batteries in a fire as they may explode. Batteries may also explode if damaged. Dispose of batteries according to local regulations. Please recycle when possible. Do not dispose as household waste.

Do not dismantle, cut, open, crush, bend, deform, puncture, or shred cells or batteries. In the event of a battery leak, do not allow the liquid to come in contact with the skin or eyes. In the event of such a leak, flush your skin or eyes immediately with water, or seek medical help.

Do not modify, remanufacture, attempt to insert foreign objects into the battery, or immerse or expose it to water or other liquids.

Improper battery use may result in a fire, explosion, or other hazard. If the device or battery is dropped, especially on a hard surface, and you believe the battery has been damaged, take it to a service centre for inspection before continuing to use it.

Use the battery only for its intended purpose. Never use any charger or battery that is damaged. Keep your battery out of the reach of small children.



Important: Battery talk and standby times are estimates only and depend on signal strength, network conditions, features used, battery age and condition, temperatures to which battery is exposed, use in digital mode, and many other factors. The amount of time a device is used for calls will affect its standby time. Likewise, the amount of time that the device is turned on and in the standby mode will affect its talk time.

■ Nokia battery authentication guidelines

Always use original Nokia batteries for your safety. To check that you are getting an original Nokia battery, purchase it from an authorised Nokia dealer, and inspect the hologram label using the following steps:

Successful completion of the steps is not a total assurance of the authenticity of the battery. If you have any reason to believe that your battery is not an authentic, original Nokia battery, you should refrain from using it, and take it to the nearest authorised Nokia service point or dealer for assistance. Your authorised Nokia service point or dealer will inspect the battery for authenticity. If authenticity cannot be verified, return the battery to the place of purchase.

Authenticate hologram

1. When you look at the hologram on the label, you should see the Nokia connecting hands symbol from one angle and the Nokia Original Enhancements logo when looking from another angle.
2. When you angle the hologram left, right, down and up, you should see 1, 2, 3 and 4 dots on each side respectively.



What if your battery is not authentic?

If you cannot confirm that your Nokia battery with the hologram on the label is an authentic Nokia battery, please do not use the battery. Take it to the nearest authorised Nokia service point or dealer for assistance. The use of a battery that is not approved by the manufacturer may be dangerous and may result in poor performance and damage to your device and its enhancements. It may also invalidate any approval or warranty applying to the device.

To find out more about original Nokia batteries, visit www.nokia.com/battery.

Care and maintenance

Your device is a product of superior design and craftsmanship and should be treated with care. The following suggestions will help you protect your warranty coverage.

- Keep the device dry. Precipitation, humidity, and all types of liquids or moisture can contain minerals that will corrode electronic circuits. If your device does get wet, remove the battery, and allow the device to dry completely before replacing it.
- Do not use or store the device in dusty, dirty areas. Its moving parts and electronic components can be damaged.
- Do not store the device in hot areas. High temperatures can shorten the life of electronic devices, damage batteries, and warp or melt certain plastics.
- Do not store the device in cold areas. When the device returns to its normal temperature, moisture can form inside the device and damage electronic circuit boards.
- Do not attempt to open the device other than as instructed in this guide.
- Do not drop, knock, or shake the device. Rough handling can break internal circuit boards and fine mechanics.
- Do not use harsh chemicals, cleaning solvents, or strong detergents to clean the device.
- Do not paint the device. Paint can clog the moving parts and prevent proper operation.
- Use a soft, clean, dry cloth to clean any lenses, such as camera, proximity sensor, and light sensor lenses.
- Use only the supplied or an approved replacement antenna. Unauthorised antennas, modifications, or attachments could damage the device and may violate regulations governing radio devices.
- Use chargers indoors.
- Always create a backup of data you want to keep, such as contacts and calendar notes.
- To reset the device from time to time for optimum performance, power off the device and remove the battery.

These suggestions apply equally to your device, battery, charger, or any enhancement. If any device is not working properly, take it to the nearest authorised service facility for service.



Disposal

The crossed-out wheeled-bin symbol on your product, literature, or packaging reminds you that all electrical and electronic products, batteries, and accumulators must be taken to separate collection at the end of their working life. This requirement applies to the European Union and other locations where separate collection systems are available. Do not dispose of these products as unsorted municipal waste.

By returning the products to collection you help prevent uncontrolled waste disposal and promote the reuse of material resources. More detailed information is available from the product retailer, local waste authorities, national producer responsibility organizations, or your local Nokia representative. For the product Eco-Declaration or instructions for returning your obsolete product, go to country-specific information at www.nokia.com.

Additional safety information

■ Small children

Your device and its enhancements may contain small parts. Keep them out of the reach of small children.

■ Operating environment

This device meets RF exposure guidelines when used either in the normal use position against the ear or when positioned at least 1.5 centimeters (5/8 inch) away from the body. When a carry case, belt clip, or holder is used for body-worn operation, it should not contain metal and should position the device the above-stated distance from your body. To transmit data files or messages, this device requires a quality connection to the network. In some cases, transmission of data files or messages may be delayed until such a connection is available. Ensure the above separation distance instructions are followed until the transmission is completed.

Parts of the device are magnetic. Metallic materials may be attracted to the device. Do not place credit cards or other magnetic storage media near the device, because information stored on them may be erased.

■ Medical devices

Operation of any radio transmitting equipment, including wireless phones, may interfere with the functionality of inadequately protected medical devices. Consult a physician or the manufacturer of the medical device to determine if they are adequately shielded from external RF energy or if you have any questions. Switch off your device in health care facilities when any regulations posted in these areas instruct you to do so. Hospitals or health care facilities may be using equipment that could be sensitive to external RF energy.

Implanted medical devices

Manufacturers of medical devices recommend that a minimum separation of 15.3 centimeters (6 inches) should be maintained between a wireless device and an implanted medical device, such as a pacemaker or implanted cardioverter defibrillator, to avoid potential interference with the medical device. Persons who have such devices should:

- Always keep the wireless device more than 15.3 centimeters (6 inches) from the medical device when the wireless device is turned on.
- Not carry the wireless device in a breast pocket.
- Hold the wireless device to the ear opposite the medical device to minimise the potential for interference.
- Turn the wireless device off immediately if there is any reason to suspect that interference is taking place.
- Read and follow the directions from the manufacturer of their implanted medical device.

If you have any questions about using your wireless device with an implanted medical device, consult your health care provider.

Hearing aids

Some digital wireless devices may interfere with some hearing aids. If interference occurs, consult your service provider.

■ Vehicles

RF signals may affect improperly installed or inadequately shielded electronic systems in motor vehicles such as electronic fuel injection systems, electronic antiskid (antilock) braking systems, electronic speed control systems, and air bag systems. For more information, check with the manufacturer, or its representative, of your vehicle or any equipment that has been added.

Only qualified personnel should service the device or install the device in a vehicle. Faulty installation or service may be dangerous and may invalidate any warranty that may apply to the device. Check regularly that all wireless device equipment in your vehicle is mounted and operating properly. Do not store or carry flammable liquids, gases, or explosive materials in the same compartment as the device, its parts, or enhancements. For vehicles equipped with an air bag, remember that air bags inflate with great force. Do not place objects, including installed or portable wireless equipment in the area over the air bag or in the air bag deployment area. If in-vehicle wireless equipment is improperly installed and the air bag inflates, serious injury could result.

Using your device while flying in aircraft is prohibited. Switch off your device before boarding an aircraft. The use of wireless teledevices in an aircraft may be dangerous to the operation of the aircraft, disrupt the wireless telephone network, and may be illegal.

■ Potentially explosive environments

Switch off your device when in any area with a potentially explosive atmosphere, and obey all signs and instructions. Potentially explosive atmospheres include areas where you would normally be advised to turn off your vehicle engine. Sparks in such areas could cause an explosion or fire resulting in bodily injury or even death. Switch off the device at refuelling points such as near gas pumps at service stations. Observe restrictions on the use of radio equipment in fuel depots, storage, and distribution areas; chemical plants; or where blasting operations are in progress. Areas with a potentially explosive atmosphere are often, but not always, clearly marked. They include below deck on boats, chemical transfer or storage facilities and areas where the air contains chemicals or particles such as grain, dust, or metal powders. You should check with the manufacturers of vehicles using liquefied petroleum gas (such as propane or butane) to determine if this device can be safely used in their vicinity.

■ Emergency calls



Important: This device operates using radio signals, wireless networks, landline networks, and user-programmed functions. If your device supports voice calls over the internet (internet calls), activate both the internet calls and the cellular phone. The device will attempt to make emergency calls over both the cellular networks and through your internet call provider if both are activated. Connections in all conditions cannot be guaranteed. You should never rely solely on any wireless device for essential communications like medical emergencies.

To make an emergency call:

1. If the device is not on, switch it on. Check for adequate signal strength. Depending on your device, you may also need to complete the following:
 - Insert a SIM card if your device uses one.
 - Remove certain call restrictions you have activated in your device.
 - Change your profile from offline or flight profile mode to an active profile.
2. Press the end key as many times as needed to clear the display and ready the device for calls.
3. Enter the official emergency number for your present location. Emergency numbers vary by location.
4. Press the call key.

When making an emergency call, give all the necessary information as accurately as possible. Your wireless device may be the only means of communication at the scene of an accident. Do not end the call until given permission to do so.

■ Certification information (SAR)

This mobile device meets guidelines for exposure to radio waves.

Your mobile device is a radio transmitter and receiver. It is designed not to exceed the limits for exposure to radio waves recommended by international guidelines. These guidelines

were developed by the independent scientific organization ICNIRP and include safety margins designed to assure the protection of all persons, regardless of age and health.

The exposure guidelines for mobile devices employ a unit of measurement known as the Specific Absorption Rate or SAR. The SAR limit stated in the ICNIRP guidelines is 2.0 watts/kilogram (W/kg) averaged over 10 grams of tissue. Tests for SAR are conducted using standard operating positions with the device transmitting at its highest certified power level in all tested frequency bands. The actual SAR level of an operating device can be below the maximum value because the device is designed to use only the power required to reach the network. That amount changes depending on a number of factors such as how close you are to a network base station. The highest SAR value under the ICNIRP guidelines for use of the device at the ear is 0.76 W/kg.

Use of device accessories and enhancements may result in different SAR values. SAR values may vary depending on national reporting and testing requirements and the network band. Additional SAR information may be provided under product information at www.nokia.com.

Your mobile device is also designed to meet the requirements for exposure to radio waves established by the Federal Communications Commission (USA) and Industry Canada. These requirements set a SAR limit of 1.6 W/kg averaged over one gram of tissue. The highest SAR value reported under this standard during product certification for use at the ear is 0.83 W/kg and when properly worn on the body is 1.05 W/kg.

Index

A

A-GPS 34
alarm clock. See clock.
assisted GPS 34

B

barring password 19
Bluetooth
 connection settings 68
 receiving data 69
 sending data 68
bookmarks 53

C

cache 55
calendar 57
calibrating compass 37
call register. See log.
calls
 answering 22
 barring 24
 ending 20
 international 20
 making 20
 rejecting 22
 speed dial 21
 waiting 22
camera
 capturing images 45
 recording video clips 46
charging battery 10
clock 57
closing applications 17
compass 37
conference call 22
connection manager 71
connectivity 66
contacts 32
 memory consumption 33
converter 58

D

data cable. See USB
device manager 65
dictionary. See mobile dictionary
diverting calls 24

E

e-mail messages 30

F

file manager 64
finding locations 37
Flash Player 53
forwarding calls. See diverting calls

G

gallery 42
GPS
 GPS connection 33
 maps 35
 positioning 33

H

help 8

I

indicators
 GPS light 16
 icons 15
 status light 16

K

keyguard. See keypad lock.
keypad lock 17

L

listening to music 47
lock code 11, 18
log 26

M

maps
 browsing maps 36
 marking items 16
media player. See RealPlayer.
menu 16
messages
 listening to 31
 service messages 29

- SIM messages 31
- mobile dictionary 58
- motion sensor 17
- music player
 - downloading music 48
 - music shop 48
 - playlists 48
 - transferring music 48

N

- notes 58
 - active notes 57

O

- offline mode. See offline profile
- offline profile 14
- one-touch dial. See speed dialling.
- operator selection 25

P

- paired devices 69
- phonebook. See contacts.
- PIN 11, 18
 - module PIN 19
 - signing PIN 19
- positioning 33
- profiles 56
- PTT. See push to talk.
- PUK 19
- push to talk 70

R

- radio 51
- RealPlayer
- recorder 53
- ringing tones 33
 - video ringing tones 42

S

- saving locations 38
- screen saver 16
- sensor settings 17
- service commands 31
- settings
 - connection 61

- data call 61
- messaging 31
- packet data 61
- phone 60
- Setting wizard 12
- speech 62
- writing language 27
- sharing online 43
- software updates 66
- speed dialling 21
- standby theme 14
- switching between applications 17
- synchronisation 70

T

- text input 27
- themes 56
- transferring data 66
- transferring music 48

U

- updating software 66
- UPIN 18
- USB 69
- using phone without a SIM card 14

V

- video call 23
- video sharing 25
- voice commands 60
- voice dialling 21
- voice mailbox 21
- voice recorder. See recorder.
- volume 17

W

- web
 - connection security 53
 - feeds 55
 - saving a page 55
 - viewing a saved page 55
 - viewing bookmarks 53
- world clock. See clock.
- writing text. See text input.