

RANGER™ 9

IM511-D

OCTOBER, 2000

Multi-Process Gasoline Engine Driven Welder and Power Generator

For use with machines having Code Number 10378, 10379, 10539, 10540 and 10550

Safety Depends on You

Lincoln arc welding and cutting equipment is designed and built with safety in mind. However, your overall safety can be increased by proper installation ... and thoughtful operation on your part. **DO NOT INSTALL, OPERATE OR REPAIR THIS EQUIPMENT WITHOUT READING THIS MANUAL AND THE SAFETY PRECAUTIONS CONTAINED THROUGHOUT.** And, most importantly, think before you act and be careful.

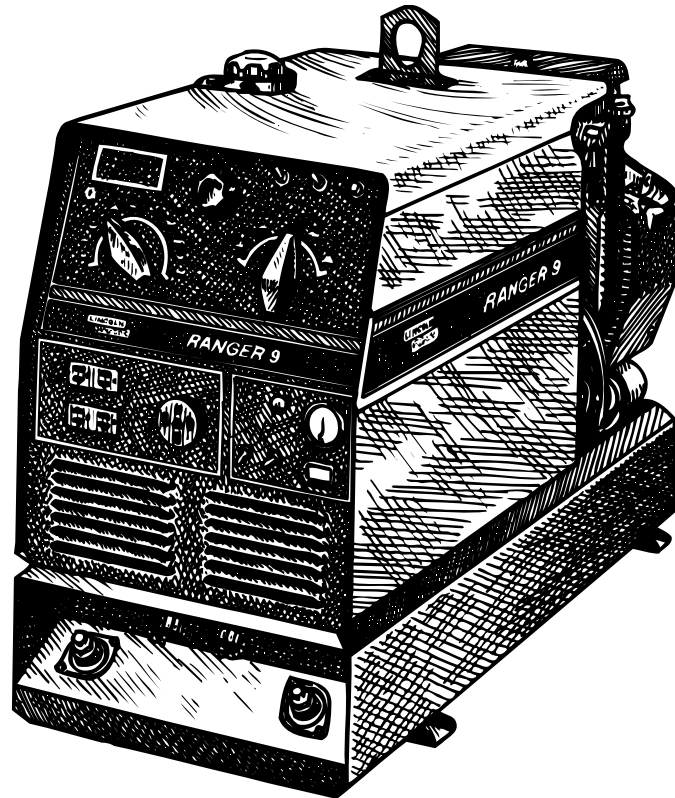

This manual covers equipment which is obsolete and no longer in production by The Lincoln Electric Co. Specifications and availability of optional features may have changed.

Date of Purchase: _____
Serial Number: _____
Code Number: _____
Model: _____
Where Purchased: _____



OPERATOR'S MANUAL

LINCOLN®
ELECTRIC

Copyright © 2000 Lincoln Global Inc.

- World's Leader in Welding and Cutting Products •
- Sales and Service through Subsidiaries and Distributors Worldwide •

Cleveland, Ohio 44117-1199 U.S.A. TEL: 216.481.8100 FAX: 216.486.1751 WEB SITE: www.lincolnelectric.com

⚠ WARNING

⚠ CALIFORNIA PROPOSITION 65 WARNINGS ⚠

Diesel engine exhaust and some of its constituents are known to the State of California to cause cancer, birth defects, and other reproductive harm.

The Above For Diesel Engines

The engine exhaust from this product contains chemicals known to the State of California to cause cancer, birth defects, or other reproductive harm.

The Above For Gasoline Engines

ARC WELDING CAN BE HAZARDOUS. PROTECT YOURSELF AND OTHERS FROM POSSIBLE SERIOUS INJURY OR DEATH. KEEP CHILDREN AWAY. PACEMAKER WEARERS SHOULD CONSULT WITH THEIR DOCTOR BEFORE OPERATING.

Read and understand the following safety highlights. For additional safety information, it is strongly recommended that you purchase a copy of "Safety in Welding & Cutting - ANSI Standard Z49.1" from the American Welding Society, P.O. Box 351040, Miami, Florida 33135 or CSA Standard W117.2-1974. A Free copy of "Arc Welding Safety" booklet E205 is available from the Lincoln Electric Company, 22801 St. Clair Avenue, Cleveland, Ohio 44117-1199.

BE SURE THAT ALL INSTALLATION, OPERATION, MAINTENANCE AND REPAIR PROCEDURES ARE PERFORMED ONLY BY QUALIFIED INDIVIDUALS.



FOR ENGINE powered equipment.

1.a. Turn the engine off before troubleshooting and maintenance work unless the maintenance work requires it to be running.



1.b. Operate engines in open, well-ventilated areas or vent the engine exhaust fumes outdoors.



1.c. Do not add the fuel near an open flame welding arc or when the engine is running. Stop the engine and allow it to cool before refueling to prevent spilled fuel from vaporizing on contact with hot engine parts and igniting. Do not spill fuel when filling tank. If fuel is spilled, wipe it up and do not start engine until fumes have been eliminated.

1.d. Keep all equipment safety guards, covers and devices in position and in good repair. Keep hands, hair, clothing and tools away from V-belts, gears, fans and all other moving parts when starting, operating or repairing equipment.

1.e. In some cases it may be necessary to remove safety guards to perform required maintenance. Remove guards only when necessary and replace them when the maintenance requiring their removal is complete. Always use the greatest care when working near moving parts.



1.f. Do not put your hands near the engine fan. Do not attempt to override the governor or idler by pushing on the throttle control rods while the engine is running.

1.g. To prevent accidentally starting gasoline engines while turning the engine or welding generator during maintenance work, disconnect the spark plug wires, distributor cap or magneto wire as appropriate.

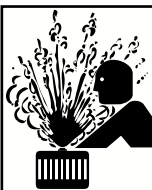

1.h. To avoid scalding, do not remove the radiator pressure cap when the engine is hot.



ELECTRIC AND MAGNETIC FIELDS may be dangerous

2.a. Electric current flowing through any conductor causes localized Electric and Magnetic Fields (EMF). Welding current creates EMF fields around welding cables and welding machines

2.b. EMF fields may interfere with some pacemakers, and welders having a pacemaker should consult their physician before welding.

2.c. Exposure to EMF fields in welding may have other health effects which are now not known.

2.d. All welders should use the following procedures in order to minimize exposure to EMF fields from the welding circuit:

2.d.1. Route the electrode and work cables together - Secure them with tape when possible.

2.d.2. Never coil the electrode lead around your body.

2.d.3. Do not place your body between the electrode and work cables. If the electrode cable is on your right side, the work cable should also be on your right side.

2.d.4. Connect the work cable to the workpiece as close as possible to the area being welded.

2.d.5. Do not work next to welding power source.



ELECTRIC SHOCK can kill.

3.a. The electrode and work (or ground) circuits are electrically "hot" when the welder is on. Do not touch these "hot" parts with your bare skin or wet clothing. Wear dry, hole-free gloves to insulate hands.

- 3.b. Insulate yourself from work and ground using dry insulation. Make certain the insulation is large enough to cover your full area of physical contact with work and ground.

In addition to the normal safety precautions, if welding must be performed under electrically hazardous conditions (in damp locations or while wearing wet clothing; on metal structures such as floors, gratings or scaffolds; when in cramped positions such as sitting, kneeling or lying, if there is a high risk of unavoidable or accidental contact with the workpiece or ground) use the following equipment:

- Semiautomatic DC Constant Voltage (Wire) Welder.
- DC Manual (Stick) Welder.
- AC Welder with Reduced Voltage Control.

- 3.c. In semiautomatic or automatic wire welding, the electrode, electrode reel, welding head, nozzle or semiautomatic welding gun are also electrically "hot".
- 3.d. Always be sure the work cable makes a good electrical connection with the metal being welded. The connection should be as close as possible to the area being welded.
- 3.e. Ground the work or metal to be welded to a good electrical (earth) ground.
- 3.f. Maintain the electrode holder, work clamp, welding cable and welding machine in good, safe operating condition. Replace damaged insulation.
- 3.g. Never dip the electrode in water for cooling.
- 3.h. Never simultaneously touch electrically "hot" parts of electrode holders connected to two welders because voltage between the two can be the total of the open circuit voltage of both welders.
- 3.i. When working above floor level, use a safety belt to protect yourself from a fall should you get a shock.
- 3.j. Also see Items 6.c. and 8.



ARC RAYS can burn.

4.a. Use a shield with the proper filter and cover plates to protect your eyes from sparks and the rays of the arc when welding or observing open arc welding. Headshield and filter lens should conform to ANSI Z87. 1 standards.

- 4.b. Use suitable clothing made from durable flame-resistant material to protect your skin and that of your helpers from the arc rays.
- 4.c. Protect other nearby personnel with suitable, non-flammable screening and/or warn them not to watch the arc nor expose themselves to the arc rays or to hot spatter or metal.



FUMES AND GASES can be dangerous.

5.a. Welding may produce fumes and gases hazardous to health. Avoid breathing these fumes and gases. When welding, keep your head out of the fume. Use enough ventilation and/or exhaust at the arc to keep

fumes and gases away from the breathing zone. **When welding with electrodes which require special ventilation such as stainless or hard facing (see instructions on container or MSDS) or on lead or cadmium plated steel and other metals or coatings which produce highly toxic fumes, keep exposure as low as possible and below Threshold Limit Values (TLV) using local exhaust or mechanical ventilation. In confined spaces or in some circumstances, outdoors, a respirator may be required. Additional precautions are also required when welding on galvanized steel.**

- 5.b. Do not weld in locations near chlorinated hydrocarbon vapors coming from degreasing, cleaning or spraying operations. The heat and rays of the arc can react with solvent vapors to form phosgene, a highly toxic gas, and other irritating products.
- 5.c. Shielding gases used for arc welding can displace air and cause injury or death. Always use enough ventilation, especially in confined areas, to insure breathing air is safe.
- 5.d. Read and understand the manufacturer's instructions for this equipment and the consumables to be used, including the material safety data sheet (MSDS) and follow your employer's safety practices. MSDS forms are available from your welding distributor or from the manufacturer.
- 5.e. Also see item 1.b.

Mar '95

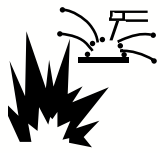

WELDING SPARKS can cause fire or explosion.

6.a. Remove fire hazards from the welding area. If this is not possible, cover them to prevent the welding sparks from starting a fire.

Remember that welding sparks and hot materials from welding can easily go through small cracks and openings to adjacent areas. Avoid welding near hydraulic lines. Have a fire extinguisher readily available.

- 6.b. Where compressed gases are to be used at the job site, special precautions should be used to prevent hazardous situations. Refer to "Safety in Welding and Cutting" (ANSI Standard Z49.1) and the operating information for the equipment being used.
- 6.c. When not welding, make certain no part of the electrode circuit is touching the work or ground. Accidental contact can cause overheating and create a fire hazard.
- 6.d. Do not heat, cut or weld tanks, drums or containers until the proper steps have been taken to insure that such procedures will not cause flammable or toxic vapors from substances inside. They can cause an explosion even though they have been "cleaned". For information, purchase "Recommended Safe Practices for the Preparation for Welding and Cutting of Containers and Piping That Have Held Hazardous Substances", AWS F4.1 from the American Welding Society (see address above).
- 6.e. Vent hollow castings or containers before heating, cutting or welding. They may explode.
- 6.f. Sparks and spatter are thrown from the welding arc. Wear oil free protective garments such as leather gloves, heavy shirt, cuffless trousers, high shoes and a cap over your hair. Wear ear plugs when welding out of position or in confined places. Always wear safety glasses with side shields when in a welding area.
- 6.g. Connect the work cable to the work as close to the welding area as practical. Work cables connected to the building framework or other locations away from the welding area increase the possibility of the welding current passing through lifting chains, crane cables or other alternate circuits. This can create fire hazards or overheat lifting chains or cables until they fail.
- 6.h. Also see item 1.c.

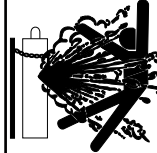

CYLINDER may explode if damaged.

7.a. Use only compressed gas cylinders containing the correct shielding gas for the process used and properly operating regulators designed for the gas and pressure used. All hoses, fittings, etc. should be suitable for the application and maintained in good condition.

- 7.b. Always keep cylinders in an upright position securely chained to an undercarriage or fixed support.
- 7.c. Cylinders should be located:
 - Away from areas where they may be struck or subjected to physical damage.
 - A safe distance from arc welding or cutting operations and any other source of heat, sparks, or flame.
- 7.d. Never allow the electrode, electrode holder or any other electrically "hot" parts to touch a cylinder.
- 7.e. Keep your head and face away from the cylinder valve outlet when opening the cylinder valve.
- 7.f. Valve protection caps should always be in place and hand tight except when the cylinder is in use or connected for use.
- 7.g. Read and follow the instructions on compressed gas cylinders, associated equipment, and CGA publication P-1, "Precautions for Safe Handling of Compressed Gases in Cylinders," available from the Compressed Gas Association 1235 Jefferson Davis Highway, Arlington, VA 22202.



FOR ELECTRICALLY powered equipment.

- 8.a. Turn off input power using the disconnect switch at the fuse box before working on the equipment.
- 8.b. Install equipment in accordance with the U.S. National Electrical Code, all local codes and the manufacturer's recommendations.
- 8.c. Ground the equipment in accordance with the U.S. National Electrical Code and the manufacturer's recommendations.

Mar '95

PRÉCAUTIONS DE SÛRETÉ

Pour votre propre protection lire et observer toutes les instructions et les précautions de sûreté spécifiques qui paraissent dans ce manuel aussi bien que les précautions de sûreté générales suivantes:

Sûreté Pour Soudage A L'Arc

1. Protégez-vous contre la secousse électrique:
 - a. Les circuits à l'électrode et à la pièce sont sous tension quand la machine à souder est en marche. Eviter toujours tout contact entre les parties sous tension et la peau nue ou les vêtements mouillés. Porter des gants secs et sans trous pour isoler les mains.
 - b. Faire très attention de bien s'isoler de la masse quand on soude dans des endroits humides, ou sur un plancher métallique ou des grilles métalliques, principalement dans les positions assis ou couché pour lesquelles une grande partie du corps peut être en contact avec la masse.
 - c. Maintenir le porte-électrode, la pince de masse, le câble de soudage et la machine à souder en bon et sûr état de fonctionnement.
 - d. Ne jamais plonger le porte-électrode dans l'eau pour le refroidir.
 - e. Ne jamais toucher simultanément les parties sous tension des porte-électrodes connectés à deux machines à souder parce que la tension entre les deux pinces peut être le total de la tension à vide des deux machines.
 - f. Si on utilise la machine à souder comme une source de courant pour soudage semi-automatique, ces précautions pour le porte-électrode s'appliquent aussi au pistolet de soudage.
2. Dans le cas de travail au dessus du niveau du sol, se protéger contre les chutes dans le cas où on recoit un choc. Ne jamais enrrouler le câble-électrode autour de n'importe quelle partie du corps.
3. Un coup d'arc peut être plus sévère qu'un coup de soleil, donc:
 - a. Utiliser un bon masque avec un verre filtrant approprié ainsi qu'un verre blanc afin de se protéger les yeux du rayonnement de l'arc et des projections quand on soude ou quand on regarde l'arc.
 - b. Porter des vêtements convenables afin de protéger la peau de soudeur et des aides contre le rayonnement de l'arc.
 - c. Protéger l'autre personnel travaillant à proximité au soudage à l'aide d'écrans appropriés et non-inflammables.
4. Des gouttes de laitier en fusion sont émises de l'arc de soudage. Se protéger avec des vêtements de protection libres de l'huile, tels que les gants en cuir, chemise épaisse, pantalons sans revers, et chaussures montantes.
5. Toujours porter des lunettes de sécurité dans la zone de

soudage. Utiliser des lunettes avec écrans latéraux dans les zones où l'on pique le laitier.

6. Eloigner les matériaux inflammables ou les recouvrir afin de prévenir tout risque d'incendie dû aux étincelles.
7. Quand on ne soude pas, poser la pince à un endroit isolé de la masse. Un court-circuit accidentel peut provoquer un échauffement et un risque d'incendie.
8. S'assurer que la masse est connectée le plus près possible de la zone de travail qu'il est pratique de le faire. Si on place la masse sur la charpente de la construction ou d'autres endroits éloignés de la zone de travail, on augmente le risque de voir passer le courant de soudage par les chaînes de levage, câbles de grue, ou autres circuits. Cela peut provoquer des risques d'incendie ou d'échauffement des chaînes et des câbles jusqu'à ce qu'ils se rompent.
9. Assurer une ventilation suffisante dans la zone de soudage. Ceci est particulièrement important pour le soudage de tôles galvanisées plombées, ou cadmiées ou tout autre métal qui produit des fumées toxiques.
10. Ne pas souder en présence de vapeurs de chlore provenant d'opérations de dégraissage, nettoyage ou pistologie. La chaleur ou les rayons de l'arc peuvent réagir avec les vapeurs du solvant pour produire du phosgène (gas fortement toxique) ou autres produits irritants.
11. Pour obtenir de plus amples renseignements sur la sûreté, voir le code "Code for safety in welding and cutting" CSA Standard W 117.2-1974.

PRÉCAUTIONS DE SÛRETÉ POUR LES MACHINES À SOUDER À TRANSFORMATEUR ET À REDRESSEUR

1. Relier à la terre le châssis du poste conformément au code de l'électricité et aux recommandations du fabricant. Le dispositif de montage ou la pièce à souder doit être branché à une bonne mise à la terre.
2. Autant que possible, l'installation et l'entretien du poste seront effectués par un électricien qualifié.
3. Avant de faire des travaux à l'intérieur de poste, la débrancher à l'interrupteur à la boîte de fusibles.
4. Garder tous les couvercles et dispositifs de sûreté à leur place.

Thank You

for selecting a **QUALITY** product by Lincoln Electric. We want you to take pride in operating this Lincoln Electric Company product ••• as much pride as we have in bringing this product to you!

Please Examine Carton and Equipment For Damage Immediately

When this equipment is shipped, title passes to the purchaser upon receipt by the carrier. Consequently, Claims for material damaged in shipment must be made by the purchaser against the transportation company at the time the shipment is received.

Please record your equipment identification information below for future reference. This information can be found on your machine nameplate.

Model Name & Number _____

Code & Serial Number _____

Date of Purchase _____

Whenever you request replacement parts for or information on this equipment always supply the information you have recorded above.

Read this Operators Manual completely before attempting to use this equipment. Save this manual and keep it handy for quick reference. Pay particular attention to the safety instructions we have provided for your protection. The level of seriousness to be applied to each is explained below:

⚠ WARNING

This statement appears where the information **must** be followed **exactly** to avoid **serious personal injury** or **loss of life**.

⚠ CAUTION

This statement appears where the information **must** be followed to avoid **minor personal injury** or **damage to this equipment**.

TABLE OF CONTENTS

Safety Precautions	ii-iv
Introductory Information	v
General Description	7
Specifications	7-8
Optional Features	9
Recommended Equipment	10
Installation Instructions.....	11-12
Machine Grounding	11
Spark Arrester	11
Trailers	11-12
Pre-Operation Service	12
Oil	12
Fuel	12
Battery Connection.....	12
Welding Output Cables	12
Location/Ventilation	12
Operation	13-14
High Altitude Operation	13
Muffler Relocation	13
Connection of Wire Feeders	13
Connection of K428 or K446 with K624-1 Remote Output Module	13
Connection of K449 to the Ranger 9	13
Connection of LN-7 or LN-8 to the Ranger 9.....	14
Connection of the LN-742 to the Ranger 9.....	14
Connection of the Magnum Spool Gun and SG Control Module to the Ranger 9.....	14
Remote Output Control	14
High Frequency Generator for TIG welding applications	14
Operating Instructions.....	15-17
Additional Safety Precautions	15
Welder Operation	15
Welder Controls, Functions, and Operation.....	15-16
Engine Operation.....	16-17
Welding Processes	17-18
Auxiliary Power	19-20
Standby Power Information and Connection to Premises Wiring Diagram	20-21
Maintenance.....	22-23
General Instructions	22
Engine Adjustments	22
Slip Rings	22
Battery	23
Hardware.....	23
Troubleshooting.....	24-27
General Troubleshooting	24
Electronic Idler Troubleshooting	25
Output System Troubleshooting.....	26-27
Wiring Diagram	28-30
Connection Diagrams.....	31-35
Dimension Print	36
Parts Pages	P230 Series

GENERAL DESCRIPTION

The Ranger™ 9, is a twin cylinder gasoline engine driven multi-process arc welder and AC power generator. It is built in a heavy gauge steel case for durability on the job site.

RECOMMENDED PROCESSES AND EQUIPMENT

The Ranger 9 can be used for AC/DC Stick welding (CC), DC Semiautomatic wire feed welding (CV), AC/DC Tig welding (CC), and also offers a 9,000 Watt AC 115/230 Volt, 60 Hertz power generator.

For AC/DC Stick welding, the range is 40-250 Amps. There is a 100% duty cycle on all settings. The Output selector covers six ranges with remote output control for fine current adjustment. For use with a broad range of AC and DC electrodes including Fleetweld® 5P.

For DC Semi-automatic wire feed welding, three constant voltage wire feed welding settings are available giving a range of 40-250 Amps at 100% duty cycle. Excellent performance will be obtained with a broad range of Innershield® and Outershield® electrodes (FCAW). Excellent arc characteristics are available with MIG (GMAW). An output contactor is provided for optimum semiautomatic welding.

AC and DC Tig welding can be done at all constant current output settings.

The auxiliary power is provided by a 9,000 Watt, AC 115/230 Volt, 60 Hertz generator. It will operate AC power tools. It will also power a 1.5 HP motor (if started under no load). It is capable of lighting ninety 100 Watt incandescent bulbs, and can also be used for standby emergency power.

The Ranger 9 CSA machine (K1420-2) has four 15 amp circuit breakers for 115V auxiliary receptacles and two 50 amp circuit breakers for 230V receptacles. This machine is CSA approved.

SPECIFICATIONS

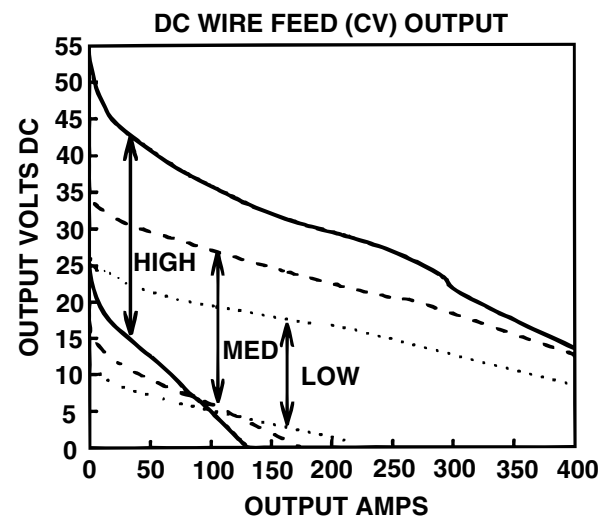
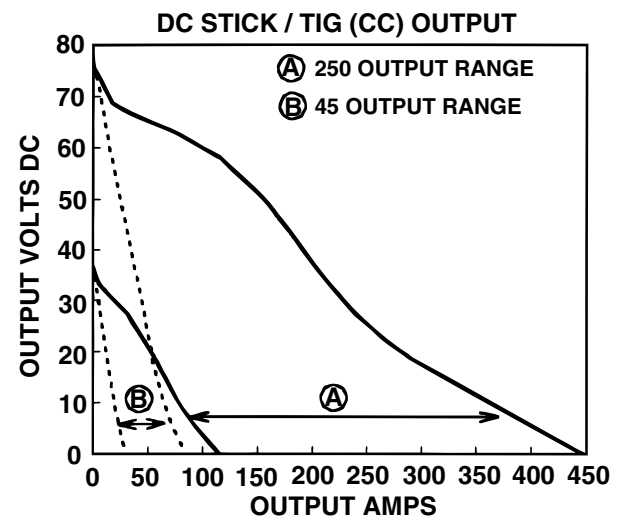
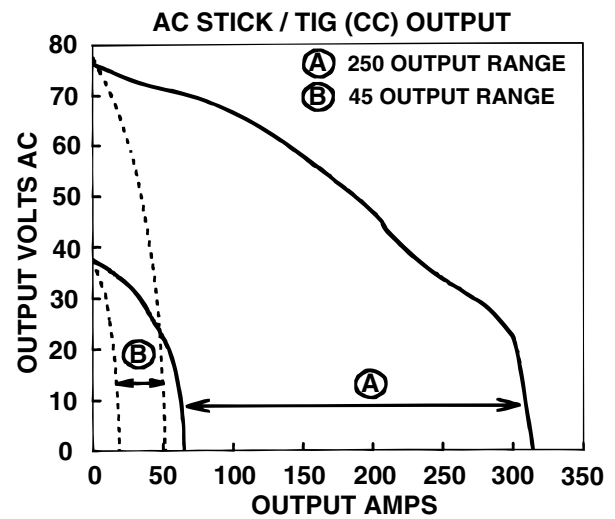

SPECIFICATIONS

Machine

Product Name	Ordering Information	Description	Rated DC Output * Amps / Volts / Duty Cycle	Auxiliary Power for Wire Feeders	AC Power **	Dimensions & Weight
Ranger 9 (Onan)	K1420-1	250 Amp AC/DC Multi-Process Arc Welder with 9,000 Watts AC Auxiliary Power	AC Constant Current 250A / 25V / 100%	42V, 60 Hz, 8 Amps	9,000 Watts 60 Hz. DC	30.3 x 19.2 x 42.3 in (770 x 488 x 1075 mm) 598 lbs (272 kg)
	K1420-2 CSA(Meets Canadian Standards)		DC Constant Current 250A / 25V / 100%	115V, 60 Hz, 8 Amps	80 Amps @ 115V	
Ranger 9 (Kohler)	K1421-1 CSA (Meets Canadian Standards)		DC Constant Voltage 250A / 25V / 100%		40 Amps @ 230V	30.3 x 19.2 x 42.3 in (770 x 488 x 1075 mm) 591 lbs (269 kg)
			Max OCV @ 3700 RPM 80V			

* Based on a 10 min. period.

** When welding, available AC auxiliary power will be reduced.

115V will operate either 60Hz or 50/60Hz power tools, lights, etc.

Engine

Product Name	Description	Horsepower	Operating Speeds	Displacement	Ignition	Capacities
Ranger 9 (Onan P218)	2 Cylinder 4 Cycle Air-Cooled Gasoline Engine. Aluminum Alloy Block with Cast Iron Liners, Electronic Ignition	18 HP @ 3600 RPM	Full Load: 3500 RPM High Idle: 3700 RPM Low Idle: 2200 RPM	47.7 cu in (782 cc)	12V Battery, 430 Cold Cranking Amps, Toggle Start Switch, Charging Ammeter, Manual Choke	Fuel: 9 Gal (34 L) Lubricating Oil: 1.8 Qts (1.7 L)
Ranger 9 (Kohler Command CH20S)		20 HP @ 3600 RPM		38.1 cu in (624 cc)		Fuel: 9 Gal (34 L) Lubricating Oil: 2.0 Qts (1.9 L)

OPTIONAL FEATURES

- A) K768-2 Two Wheel Undercarriage**
- For in-plant and yard towing. (For highway use, consult applicable federal, state, and local laws regarding possible requirements for brakes, lights, fenders, etc.) Two 4.80 x 12" four-ply tubeless tires. Bed-plate mounting. Has stand for tow bar and grips for hand pulling. Overall width 43.06" (1.09 m).
- B) K886-1 Canvas Cover**
- To protect the Ranger 9 when not in use. Made from attractive red canvas material that is flame retardant, mildew resistant, and water repellent.
- C) K894-1 Spark Arrester Kit**
- Includes a heavy gauge steel, approved spark arrester and clamp for easy mounting to muffler exhaust pipe.
- D) K896-1 GFCI Receptacle Kit**
- Includes two UL approved 115 Volt ground fault circuit interrupter duplex type receptacles with covers and installation instructions. Replaces the two factory installed 115 Volt duplex receptacles. Each receptacle of each GFCI duplex is rated at 15 Amps but the maximum total current from each GFCI duplex is limited to 20 amps.
- E) K930-1 TIG Module**
- Provides high frequency and shielding gas control for AC and DC GTAW (TIG) welding applications. Compact case is designed for easy carrying, complete with handle. High frequency bypass is built in. The K939-1 Docking Kit is available for mounting the TIG Module on top of the Ranger 9. The K936-1 control cable is required.
- F) K933-1 Four Wheel Undercarriage**
- Allows movement of the Ranger 9 by hand without lifting. Easily assembles to the Ranger 9. It includes two rugged, hard molded wheels and two durable pneumatic tires. The spring loaded handle provides convenient, comfortable steering. The K934-1 Bracket is available for mounting a gas cylinder on the undercarriage.
- G) K934-1 Bracket for Mounting a Gas Cylinder to a K933-1 Undercarriage**
- Easily mounts on the back of the K933-1 Four Wheel Undercarriage to carry a welding gas cylinder.
- H) K889-2 Two Wheel Undercarriage**
- For moving by hand. Two 4.00" x 8" industrial tires. Overall width 29" (.74m).
- I) K857 Remote Control**
- Consists of a control box with 25' (7.5 m) of four conductor cable. Permits remote adjustment of output voltage.
- J) K893-1 Caster for Two Wheel Undercarriage**
- Mounts to the front of the K889-2 Two-Wheel Undercarriage to allow easy movement on smooth surfaces. Includes a 6" diameter hard rubber wheel with a convenient toe-on, toe-off locking brake.
- K) K702 Accessory Kit**
- Accessory Set includes 35 ft. 2 AWG electrode cable, 30 ft. 2 AWG work cable, headshield with number 12 filter, work clamp, and Cooltong® 300 electrode holder. Cables are rated at 250 Amps, 40% duty cycle.
- L) K802-R Power Plug Kit**
- Provides four 115 Volt plugs rated at 15 Amps each and one dual voltage, full KVA plug rated at 115/230 Volts, 50 amps.
- M) K802-N Power Plug Kit**
- Provides four 115 Volt plugs rated at 20 Amps each and one dual voltage, full KVA plug rated at 115/230 Volts, 50 Amps. (Not for use with K1420-2 CSA machine and machines with GFCI receptacles.)

RECOMMENDED EQUIPMENT

STICK

K702 Accessory Kit which includes:

- Electrode holder and cable
- Work clamp and cable
- Headshield

K857 Remote Control Kit is optional for remote current control.

TIG

Magnum™ TIG Torch
Magnum Parts Kit and Argon gas
K930-1 TIG Module
K936-1 Control Cable

Optional:

K939-1 TIG Module Docking Kit
K963 Hand Amptrol™
K870 Foot Amptrol
K814 Arc Start Switch

WIRE FEED

LN-25 (K428 or K446) with K624-1 42 Volt Remote Output Control Module - Requires K626-xx Control Cable. Provides "cold" electrode until gun trigger is pressed. Voltage control is at the feeder. K446 LN-25 includes gas solenoid.

LN-25 (K449) Includes internal contactor for across the arc operation (no control cable). Provides "cold" electrode until gun trigger is pressed. Includes gas solenoid. K444-1 Remote Voltage Control Kit is required for voltage control at the feeder.

LN-742 (K617-1 or K618-1) or LN-742H (K617-2 or K618-2), requires K619-xx Input Cable Assembly. Provides "cold" electrode until gun trigger is pressed. Includes gas solenoid. K589-1 Remote Control Kit connects to the LN-742 to provide remote voltage and wire speed control or K857 Remote Voltage Control Kit connects to the Ranger 9 for voltage control at the feeder.

LN-7 (K521) or LN-7 GMA (K440), requires K584-xx Input Cable Assembly. Provides "cold" electrode until gun trigger is pressed. K440 LN-7 GMA included gas solenoid. K8567 Remote Voltage Control Kit is required for voltage control at the feeder. Ranger 9 must be operated at "HIGH" idle.

Magnum Gun is required for gas-shielded welding. Innershield Gun is required for gas-less welding.

INSTALLATION INSTRUCTIONS

⚠ WARNING

Do not attempt to use this equipment until you have thoroughly read the engine manufacturer's manual supplied with your welder. It includes important safety precautions, detailed engine starting, operating and maintenance instructions, and parts lists.



ELECTRIC SHOCK can kill.

- Do not touch electrically live parts or electrode with skin or wet clothing.
- Insulate yourself from work and ground
- Always wear dry insulating gloves.



ENGINE EXHAUST can kill.

- Use in open, well ventilated areas or vent exhaust outside.



MOVING PARTS can injure.

- Do not operate with doors open or guards off.
- Stop engine before servicing.
- Keep away from moving parts.

See additional warning information at front of this operator's manual.

Machine Grounding

Because this portable engine driven welder or generator creates its own power, it is not necessary to connect its frame to an earth ground, unless the machine is connected to premises wiring (your home, shop, etc.).

To prevent dangerous electric shock, other equipment to which this engine driven welder supplies power must:

- a. **be grounded to the frame of the welder using a grounded type plug, or**
- b. **be double insulated.**

When this welder is mounted on a truck or trailer, its frame must be securely connected to the metal frame of the vehicle.

Where this engine driven welder is connected to premises wiring, such as that in your home or shop, its frame must be connected to the system earth ground. See further connection instructions in the section entitled Standby Power Connections in this manual, as well as the article on grounding in the latest U.S. National Electrical Code and the local code.

In general, if the machine is to be grounded, it should be connected with a #8 or larger copper wire to a solid earth ground such as a metal water pipe going into the ground for at least ten feet and having no insulated joints, or to the metal framework of a building which has been effectively grounded. The U.S. National Electrical Code lists a number of alternate means of grounding electrical equipment. A machine grounding stud marked with the symbol  is provided on the front of the welder.

Spark Arrester

Some federal, state or local laws may require that gasoline engines be equipped with exhaust spark arresters when they are operated in certain locations where unarrested sparks may present a fire hazard. The standard muffler included with this welder does not qualify as a spark arrester. When required by local regulations, the K894-1 arrester must be installed and properly maintained.

⚠ CAUTION

Use of an incorrect arrester may lead to engine damage or performance loss.

Undercarriages

The recommended undercarriage for use with this equipment for in-plant and yard towing by a vehicle ⁽¹⁾ is Lincoln's K768-2. If the user adapts a non-Lincoln undercarriage, he must assume responsibility that the method of attachment and usage does not result in a safety hazard nor damage the welding equipment. Some of the factors to be considered are as follows:

(1) Consult applicable federal, state and local laws regarding specific requirements for use on public highways.

1. Design capacity of undercarriage vs. weight of Lincoln equipment and likely additional attachments.
2. Proper support of, and attachment to, the base of the welding equipment so there will be no undue stress to the framework.
3. Proper placement of the equipment on the undercarriage to ensure stability side to side and front to back when being moved and when standing by itself while being operated or serviced.

4. Typical conditions of use, i.e., travel speed; roughness of surface on which the trailer will be operated; environmental conditions; like maintenance.
5. Conformance with federal, state and local laws.⁽¹⁾

(1) Consult applicable federal, state and local laws regarding specific requirements for use on public highways.

PRE-OPERATION SERVICE

CAUTION

READ the engine operating and maintenance instructions supplied with this machine.

WARNING



GASOLINE fuel can cause fire or explosion.

- Stop engine while fueling.
- Do not smoke when fueling.
- Do not overfill tank.
- Keep sparks and flame away from tank.
- Wipe up spilled fuel and allow fumes to clear before starting engine.

Oil

The Ranger 9 is shipped with the engine crankcase filled with SAE 10W-30 oil. Check the oil level before starting the engine. If it is not up to the full mark on the dipstick, add oil as required. Make certain that the oil filter cap is tightened securely. Refer to the engine Operators Manual for specific oil recommendations.

LUBRICATION SYSTEM CAPACITY
(INCLUDING FILTER)
Onan P218 - 1.8 Quarts (1.7 Liters)
Kohler CH20S - 2.0 Quarts (1.9 Liters)

Fuel

Fill the fuel tank with clean, fresh lead-free gasoline. The capacity is approximately 9 gallons (34 liters). Observe the fuel gauge while filling to prevent overfilling.

Battery Connection

This welder is shipped with the negative battery cable disconnected. Make sure that the Engine Switch is in the “STOP” position and attach the disconnected cable securely to the negative battery terminal before attempting to operate the machine. If the battery is discharged and does not have enough power to start the engine, see the Maintenance-Battery section of this manual for battery charging instructions.

Welding Output Cables

With the engine off, connect the electrode and work cables to the studs provided. These connections should be checked periodically and tightened if necessary.

Listed below are copper cable sizes recommended for the rated current and duty cycle. Lengths stipulated are the distance from the welder to work and back to the welder again. Cable sizes are increased for greater lengths primarily for the purpose of minimizing cable voltage drop.

TOTAL COMBINED LENGTH OF ELECTRODE AND WORK CABLES		
	250 Amps 40% Duty Cycle	250 Amps 100% Duty Cycle
0-50 Ft.	2 AWG	1 AWG
50-100 Ft.	2 AWG	1 AWG
100-150 Ft.	1 AWG	1 AWG
150-200 Ft.	1 AWG	1 AWG
200-250 Ft.	1/0 AWG	1/0 AWG

Location / Ventilation

The welder should be located to provide an unrestricted flow of clean, cool air to the cooling air inlets and to avoid heated air coming out of the back of the welder recirculating back to the cooling air inlets below the exhaust. Also, locate the welder so that the engine exhaust fumes are properly vented to an outside area.

WARNING

Damage to fuel tank may cause fire or explosion. Do **NOT** drill holes in the Ranger 9 base or weld to the Ranger 9 base.

Angle of Operation

Engines are designed to run in the level condition which is where the optimum performance is achieved. The maximum angle of operation for the engine is 15 degrees from horizontal in any direction. If the engine is to be operated at an angle, provisions must be made for checking and maintaining the oil level at the normal (FULL) oil capacity in the crankcase.

When operating the welder at an angle, the effective fuel capacity will be slightly less than the specified 10 gallons.

High Altitude Operation

If the Ranger 9 will be consistently operated at altitudes above 5,000 feet, a carburetor jet designed for high altitudes should be installed. This will result in better fuel economy, cleaner exhaust, and longer spark plug life. It will not give increased power which is decreased at higher altitudes. Engine horsepower is reduced by 3.5% per 1000 feet for altitudes above 377 feet.

High altitude jet kits are available from the engine manufacturer. Order Onan kit part number 146-0458.

CAUTION

Do not operate a Ranger 9 with a high altitude jet installed at an altitude below 5,000 ft. This will result in the engine running too lean and result in higher engine temperatures which can shorten engine life.

Muffler Relocation

WARNING

Shut off welder and allow muffler to cool before touching muffler.

The Ranger 9 is shipped with the exhaust coming out on the left side of the machine. The exhaust can be changed to the opposite side by removing the two screws that hold the exhaust port cover in place and installing the cover on the opposite side. (Operating the Ranger 9 without the cover in place will result in a higher noise level and no increase in machine output.)

Connection of Lincoln Electric Wire Feeders

WARNING

Shut off welder before making any electrical connections.

Connection of K428 or K446 LN-25 with K624-1 42 volt Remote Output Control Module to the Ranger 9.

Requires K626-xx Control Cable. Provides “cold” electrode until gun trigger is pressed and also provides voltage control at the feeder. The K446 LN-25 includes a gas solenoid. See the appropriate connection diagram in rear of this manual.

- a. Shut off the welder.
- b. Connect the electrode cable from the LN-25 to the “ELECTRODE” stud of the welder. Connect the work cable to the “TO WORK” stud of the welder.
- c. Connect the control cable from the LN-25 to the 14 pin amphenol on the Ranger 9.
- d. Attach the single lead from the front of the LN-25 to the work using the spring clip on the end of the lead.

This is a control lead to supply the current to the wire feeder motor; it does not carry welding current.

- e. Set the “POLARITY” switch to either WIRE FEED DC+ or WIRE FEED DC- as required by the electrode being used.
- f. Set the “RANGE” switch to either HIGH, MED or LOW as required by the process.
- g. Set the “WELDING TERMINALS” Control switch to the “REMOTELY CONTROLLED” position.
- h. Set the “IDLER” switch to the “AUTO” position.

Connection of the K449 LN-25 to the Ranger 9.

- a. Shut off the welder.
- b. Connect the electrode cable from the LN-25 to the “ELECTRODE” stud of the welder. Connect the work cable to the “TO WORK” stud of the welder.
- c. Attach the single lead from the front of the LN-25 to work using the spring clip on the end of the lead. This is a control lead to supply the current to the wire feeder motor; it does not carry welding current.

- d. Set the “POLARITY” switch to either WIRE FEED DC+ or WIRE FEED DC- as required by the electrode being used.
- e. Set the “RANGE” switch to either HIGH, MED or LOW as required by the process.
- f. Set the “WELDING TERMINAL” Control switch to the “ALWAYS ON” position.
- g. Set the “IDLER” switch to the “AUTO” position.

Connection of the LN-7 or LN-8 to the Ranger 9.

- a. Shut off the welder.
- b. Connect the LN-7 or LN-8 per the instructions on the appropriate connection diagram in the rear of this manual.
- c. Set the output control toggle switch to appropriate position: “CONTROL REMOTE” for LN-8 and LN-7 with K857 attached; “CONTROL AT WELDER” for LN-7 with no remote voltage control.
- d. Set “POLARITY” switch to either WIRE FEED DC+ or WIRE FEED DC-.
- e. Set the “RANGE” switch to either HIGH, MED or LOW as required by the process.
- f. Set the “WELDING TERMINALS” Control switch to the “REMOTELY CONTROLLED” position.
- g. Set the “IDLER” switch to the “HIGH” idle position.

Connection of the LN-742 to the Ranger 9

- a. Shut off the welder.
- b. Connect per the instructions on the appropriate connection diagram in rear of this manual.
- c. Set the output control toggle switch to “CONTROL AT WELDER” when not using remote control. When the LN-742 has a K589-1 remote control attached, set output control to “REMOTE”.
- d. Set “POLARITY” switch to either WIRE FEED DC+ or WIRE FEED DC-.
- e. Set “RANGE” switch to either HIGH, MED or LOW as required by the process.
- f. Set the “WELDING TERMINAL” control switch to “REMOTELY CONTROLLED” position.
- g. Set the “IDLER” switch to the “AUTO” position.

Connection of the Magnum Spool Gun and SG Control Module to the Ranger 9

- a. Shut off the Welder.
- b. Connect per the instructions on the appropriate connection diagram in the rear of this manual.
- c. Set the output control toggle switch to “CONTROL AT WELDER” when not using remote control.
- d. Set the “POLARITY” switch to WIRE FEED DC+.
- e. Set the “RANGE” switch to either HIGH, MED or LOW as required by the process.
- f. Set the “WELDING TERMINALS” Control switch to the “REMOTELY CONTROLLED” position.
- g. Set the “IDLER” switch to the “HIGH” idle position.

Remote Output Control

The Ranger 9 has a 6-pin and a 14-pin Amphenol connector. These connectors are located above the output studs. The 6-pin connector is intended to be used with the optional K857 Remote Output Control or in the case of TIG welding applications, with the Foot or Hand Amptrol. The 14-pin connector is used to connect a wire feeder control cable. If the wire feeder has a built-in power source output control, do not connect a remote output control to the 6-pin connector. When remote output control is used, the output control toggle switch is to be set at “CONTROL REMOTE”.

High Frequency Generator for TIG welding applications

The K930-1 TIG Module is an accessory that provides high frequency and shielding gas control for AC and DC GTAW (TIG) welding. See IM528 supplied with the TIG Module for installation instructions.

Note: The TIG Module does not require the use of a high frequency bypass capacitor. If any other high frequency accessory is used with the Ranger 9, a bypass capacitor (Order Kit T12246) must be installed in the Ranger 9.

OPERATING INSTRUCTIONS

Additional Safety Precautions

Always operate the welder with the roof and case sides in place as this provides maximum protection from moving parts and assures proper cooling air flow.

Read carefully the Safety Precautions page in the Instruction Manual before operating this machine. Always follow these and any other safety procedures included in this manual and in the Engine Instruction Manual.

Welder Operation

Welder Output	RANGER 9
Constant Current	250 amps AC @ 25 volts 250 amps DC @ 25 volts
Constant Voltage	250 amps DC @ 25 volts

- Maximum Open Circuit Voltage at 3700 RPM is 80 volts.
- Duty Cycle: 100% for both welding and auxiliary power.

Ranger 9 Approximate Fuel Consumption

	ONAN P218 PERFORMER	KOHLER CH20S
Low Idle - No Load 2200 RPM	.4 gallons/hour (1.5 liters/hour)	.4 gallons/hour (1.5 liters/hour)
High Idle - No Load 3700 RPM	.8 gallons/hour (3.1 liters/hour)	1.0 gallons/hour (3.9 liters/hour)
AC CC Weld Output 250 Amps @ 25 Volts	1.6 gallons/hour (6.2 liters/hour)	1.5 gallons/hour (5.7 liters/hour)
DC CC Weld Output 250 Amps @ 25 Volts	1.8 gallons/hour (7.0 liters/hour)	1.7 gallons/hour (6.5 liters/hour)
DC CV Weld Output 250 Amps @ 25 Volts	1.7 gallons/hour (6.5 liters/hour)	1.6 gallons/hour (6.2 liters/hour)
Auxiliary Power 9000 kVA	1.8 gallons/hour (7.0 liters/hour)	1.7 gallons/hour (6.5 liters/hour)

Welder Controls - Function and Operation

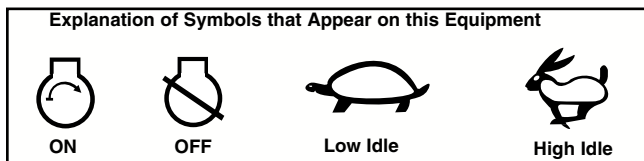

ENGINE “ON-OFF” Switch

When placed in the “ON” position, this switch energizes the engine ignition circuit. When placed in the “OFF” position, the ignition circuit is de-energized to shut down the engine.

ENGINE “START” Push-Button Switch

Energizes engine starter motor.

“POLARITY” Switch

Three STICK/TIG (constant current) polarity settings:
DC+, DC- and AC

Two wire feed (constant voltage) settings:
DC+ and DC-

NOTE: The setting of this switch must match the color band setting of the Range Switch (both switches must be set for the same welding process).

⚠ CAUTION

Never change the “POLARITY” switch setting while welding. This will damage the switch.

“ RANGE” Switch

STICK/TIG (constant current) range settings	6	45,90,120, 160,200,250
WIRE FEED (constant voltage) range settings	3	LOW,MED,HIGH

⚠ CAUTION

Never change the “RANGE” switch setting while welding. This will damage the switch.

“ CONTROL”

Provides a fine welding current adjustment within the Range Switch settings in the STICK/TIG mode and welding voltage control with the Range switch set in the WIRE FEED mode.

“CONTROL AT WELDER / REMOTE CONTROL” Switch

The toggle switch on the control panel labeled “CONTROL AT WELDER” and “REMOTE CONTROL” gives the operator the option of controlling the output at the welder control panel or at a remote station. Remote connections are made at the 6-pin or 14-pin amphenol connector.

For remote control, the toggle switch is set in the “REMOTE CONTROL” position.

For control at the welder control panel, the toggle switch is set in the “CONTROL AT WELDER” position.

“WELDING TERMINALS” Switch

The toggle switch labeled “WELDING TERMINALS ALWAYS ON” and “WELDING TERMINALS REMOTELY CONTROLLED” is used to control the operation of the welder output contactor.

With the switch in the “ALWAYS ON” position, the output contactor is closed at LOW and HIGH idle.

With the switch in the “REMOTELY CONTROLLED” position, the contactor is open at LOW idle and HIGH idle until a control cable is attached to the welder amphenol connector from a wire feeder. Under this condition, contactor closes when the wire feeder trigger is depressed and opens when the trigger is released.

“IDLER” Switch

The idler switch has two positions, “HIGH” and “AUTO”.

When in “HIGH”  position, the engine will run continuously at high idle.

When in “AUTO”  /  idle position, the idler operates as follows:

a. Welding

Low idle and in the “WELDING TERMINALS ALWAYS ON” mode - Stick Welding only. When the electrode touches work, the welding arc is initiated and the engine accelerates to full speed.

Low idle and in the “WELDING TERMINALS REMOTELY CONTROLLED” mode -Wire Welding Only Pressing the gun trigger closes the Ranger 9 output contactor and causes the engine to accelerate to full speed.

After the gun trigger is released and/or welding ceases (and no auxiliary power is being drawn), the engine will return to low idle after approximately 10 to 14 seconds.

b. Auxiliary Power - With the engine running at low idle and auxiliary power for lights or tools is drawn (approximately 100-150 watts or greater) from the receptacles, the engine will accelerate to high speed. If no power is being drawn from the receptacles (and not welding) for 10-14 seconds, the idler reduces the engine speed to low idle.

Starting/Shutdown Instructions

Starting the Engine

WARNING



- Do not touch electrically live parts of electrode with skin or wet clothing.

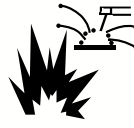

- Keep flammable material away.





- Insulate yourself from work and ground. Wear eye, ear, and body protection.



- Keep your head out of the fumes.
- Use ventilation or exhaust to remove fumes from breathing zone.

Be sure all Pre-Operation Maintenance has been performed. Also, read the Engine Owner’s Manual.

Remove all loads connected to the AC power receptacles. To start the engine, set the “Idler Control” switch in the Automatic ( / ) position.

Use the choke control as follows:

Onan Engine - If the engine is cold, pull the choke control out. Do **not** use the choke if the engine is warm or hot.

Kohler Engine - **Always** pull the choke control out when starting the engine; cold, warm or hot. Place the “Engine” switch in the “ON” position.

Push the “START” button and crank the engine until it starts. Release the button as soon as the engine starts. Do not push the “START” button while the engine is running because this will cause damage to the ring gear and/or starter motor. After the engine has started, slowly return the choke control to the full “in” position (choke open).

After running at high engine speed for 10-14 seconds, the engine will go to low idle.

Allow the engine to warm up by letting it run at low idle for a few minutes.

Stopping the Engine

Remove all welding and auxiliary power loads and allow engine to run at low idle speed for a few minutes to cool the engine.

Stop the engine by placing the “Engine” switch in the “OFF” position.

A fuel shut off valve is not required on the Ranger 8 because the fuel tank is mounted below the engine.

Break-in Period

It is normal for any engine to use a greater amount of oil until the break-in is accomplished. Check the oil level twice a day during the break-in period (approximately 50 running hours)).

IMPORTANT: IN ORDER TO ACCOMPLISH THIS BREAK-IN, THE UNIT SHOULD BE SUBJECTED TO MODERATE LOADS, WITHIN THE RATING OF THE MACHINE. AVOID LONG IDLE RUNNING PERIODS. REMOVE LOADS AND ALLOW ENGINE TO COOL BEFORE SHUTDOWN.

The engine manufacturer’s recommendation for the running time until the first oil change is as follows:

Kohler CH20S	Onan P218
5 hr	25 hr

The oil filter is to be changed at the second oil change. Refer to the Engine Owner’s Manual for more information.

Welding Processes

Stick (Constant Current) Welding

Connect welding cables to the “TO WORK” and “ELECTRODE” studs. Start the engine. Set the “POLARITY” switch to the desired polarity. Set the output “CONTROL” or remote output control to max (10) and the “RANGE” switch to the setting that is closest to the recommended current for the electrode being used and make a trial weld. A fine adjustment of the welding can be made by adjusting the output “CONTROL” or remote control. For the best arc stability, always use setting that results in the highest setting of the output or remote control and the lowest setting of the “RANGE” switch.

The Ranger 9 can be used with a broad range of AC and DC stick electrodes. See “Welding Tips 1” included with the Ranger 9 for electrodes within the rating of this unit and recommended welding currents of each. See the following table for welding current ranges:

CURRENT RANGES (AC and DC STICK WELDING - 5 to 10 ON CONTROL DIAL)

RANGE SETTING ON MACHINE	ACTUAL CURRENT RANGE
45	25 to 45 AMPS
90	50 to 90 AMPS
120	60 to 120 AMPS
160	80 to 160 AMPS
200	100 to 200 AMPS
250	140 to 250 AMPS

TIG (Constant Current) Welding

The Ranger 9 can be used in a wide variety of AC and DC Tungsten Inert Gas (TIG) welding applications for AC TIG welding up to 200 amps and DC TIG welding up to 250 amps.

The K930-1 TIG Module installed on a Ranger 9 provides high frequency and shielding gas control for AC and DC GTAW (TIG) welding processes. The TIG Module allows full range output control. Afterflow time is adjustable from 0 to 55 seconds.

When using the Ranger 9 for AC TIG welding of aluminum, the TIG Module is to be set for CONTINUOUS HF. The following settings and electrodes are recommended:

Pure (EWP) Tungsten Diameter	“Range” Switch Settings	Welding Current
1/8	90, 120	100 to 200 amps
3/32	45, 90	45 to 140 amps
1/16	45, 90	45 to 100 amps

When AC TIG welding, the actual maximum welding current is 40 to 80 amps higher than the current marked on the RANGE SWITCH dial. This is a result of a lower effective reactance due to the natural rectification that occurs with the AC TIG welding process.

Wire Feed (Constant Voltage) Welding

The Ranger 9 can be used with a broad range of flux-cored wire (Innershield and Outershield) electrodes and solid wires for MIG welding (gas metal arc welding).

Some recommended Innershield electrodes are: NR-211MP, NR-311, NR-203 series as well as, Lincore[®] 33 and 55 hardfacing electrodes. Diameters from .035 (0.9mm) up to and including 5/64” (2.0mm) can be used. 5/64” (2.0mm) NS-3M can be used in limited applications. Cable length and other conditions can affect the ultimate results of this application. Request Lincoln publication N-675 for additional information.

Recommended Outershield electrodes are: .045 (1.1mm), .052 (1.3mm) and 1/16 (1.6mm) Outershield 71 and 1/16" (1.16mm) Outershield 70. Request Lincoln publication GS-200 for additional information.

Some recommended solid wires for MIG welding are: .030 (0.8mm), .035 (0.9mm) and .045 (1.1mm) L-50 and L-56. Request Lincoln publication GS-100 for additional information.

When using a wire feeder with contactor control, the electrode will be "cold" until the gun trigger is pressed. To start the welding process, position the gun and close the gun trigger. The contactor will close, the arc will be initiated and the engine will accelerate to full speed. To stop welding, release the gun trigger and pull the gun away from the work. With the "IDLER SWITCH" in the "AUTO" position, the engine will go back to low idle in approximately 12 seconds (when no auxiliary power is drawn).

NOTE: The LN-7 and the LN-8 must be operated in the "HIGH" idle position.

SUMMARY OF WELDING PROCESS

PROCESS	CONTROL CABLE USED	IDLE MODE	OUTPUT CONTROL SWITCH	WELDING TERMINALS SWITCH	ELECTRODE WHEN NOT WELDING	TO START WELDING
STICK - CC	NO	AUTO	AT WELDER	ALWAYS ON	HOT	Touch electrode to work. Welding starts immediately and engine goes to high idle.
TIG - CC K930-1/K936-1 (WITH AMPTROL)	YES	AUTO	REMOTE	REMOTE	COLD	Press Amptrol. Welding starts immediately.
WIRE FEED - CV, LN-25 WITH 42V REMOTE CON- TROL KIT	YES	AUTO	REMOTE	REMOTE	COLD	Press gun trigger, Ranger 9 contactor closes. Welding starts immediately and engine goes to high idle.
WIRE FEED - CV, LN-25 WITH INTERNAL CONTACTOR	NO	AUTO	AT WELDER	ALWAYS ON	COLD	Press gun trigger, LN-25 contactor closes. Welding starts immediately and engine goes to high idle.
WIRE FEED - CV, LN-742	YES	AUTO	REMOTE	REMOTE	COLD	Press gun trigger, Ranger 9 contactor closes. Welding starts immediately and engine goes to high idle.
WIRE FEED - CV, LN-7	YES	HIGH	REMOTE	REMOTE	COLD	Press gun trigger, Ranger 9 contactor closes. Welding starts immediately.

Auxiliary Power

The Ranger 9 can provide up to 9,000 watts of 115/230 volts AC, single phase 60HZ power for continuous use. The front of the machine includes three receptacles for connecting AC power plugs. The K1420-1 has one 50 amp 115/230 volt NEMA 14-50R receptacle and two 20 amp 115 volt NEMA 5-20R receptacles. The K1420-2 CSA machine has one 50 amp 115/230 volt NEMA 14-50R receptacle and two 15 amp 115 volt NEMA 5-15R receptacles. Do not connect any plugs that connect to the power receptacles in parallel.

Start the engine and set the "IDLER" control switch to the desired operating mode. Set the "CONTROL" to 10. Voltage is now correct at the receptacles for auxiliary power.

115/230 Volt Dual Voltage Receptacle

The 115/230 volt receptacle can supply up to 40 amps of 230 volt power to a two wire circuit, up to 40 amps of 115 volt power from each side of a three wire circuit (up to 80 amps total). Do not connect the 115 volt circuits in parallel. Current sensing for the automatic idle feature is only in the leg of the three wire circuit as shown below.

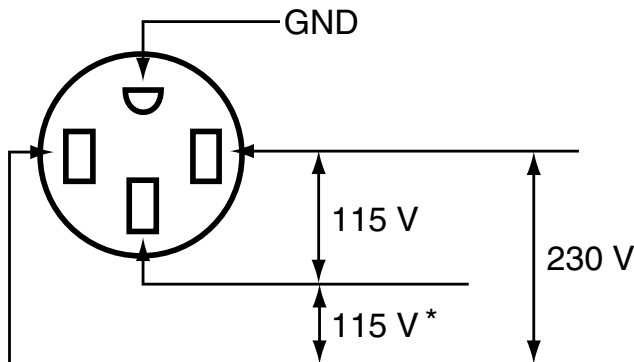

* Current Sensing for Automatic Idle (Receptacle viewed from front of machine.)

115V Duplex Receptacles

The 115V auxiliary power receptacles should only be used with three wire grounding type plugs or approved double insulated tools with two wire plugs.

Maximum Current Draw from 115V Duplex Receptacles - No Welding

LOAD FROM 115V / 230V DUAL VOLTAGE RECEPTACLE	K1420-1		K1420-2 (CSA) and K1421-1 (CSA)	
	EACH HALF OF EACH 115V DUPLEX	TOTAL FROM BOTH 115V DUPLEXES	EACH HALF OF EACH 115V DUPLEX	TOTAL FROM BOTH 115V DUPLEXES
0	20 *	78	15	60
2.2 KW	20 *	60	15	60
4.5 KW	20 *	40	15	40
6.7 KW	20 *	20	15	20
9.0 KW	0	0	0	0

* NEMA 5-20P plug required for 20 amp draw.

Maximum Current Draw from Optional 115V GFCI Duplex Receptacles - No Welding

LOAD FROM 115V / 230V DUAL VOLTAGE RECEPTACLE	K1420-1* (WITH GFCI'S)		K1420-2** and K1421-1** (WITH GFCI'S)	
	EACH HALF OF EACH 115V DUPLEX	TOTAL FROM BOTH 115V DUPLEXES	EACH HALF OF EACH 115V DUPLEX	TOTAL FROM BOTH 115V DUPLEXES
0	15	40	15	30
2.2 KW	15	40	15	30
4.5 KW	15	40	15	30
6.7 KW	15	20	15	20
9.0 KW	0	0	0	0

* Maximum current draw from each 115V GFCI Duplex is 20 amps.

** Maximum current draw from each 115V GFCI Duplex is 15 amps.

Most 1.5 HP motors can be started if there is no load on the motor or other load connected to the machine, since the full load current rating of a 1.5HP motor is approximately 20 amperes (10 amperes for 230 volt motors). The motor may be run at full load when plugged into only one side of the duplex receptacle. Larger motors through 2HP can be run provided the receptacle rating as previously stated is not exceeded. This may necessitate 230V operation only.

It must be noted that the above auxiliary power ratings are with no welding load. Simultaneous welding and power loads are permitted by the following table. The permissible currents shown assume that current is being drawn from either the 115 volt or 230 volt supply (not both at the same time).

NOTE: Voltage and permissible watts decrease as “CONTROL” is adjusted to settings less than 10. It is recommended that at settings less than 10, only incandescent lighting loads be connected to the auxiliary power receptacles.

Standby Power Connections

The Ranger 9 is suitable for temporary, standby or emergency power using the engine manufacturer's recommended maintenance schedule.

The Ranger 9 can be permanently installed as a standby power unit for 230 volt, 3-wire, 40 ampere service. Connections must be made by a licensed electrician who can determine how the 115/230 volt power can be adapted to the particular installation and comply with all applicable electrical codes. The following information can be used as a guide by the electrician for most applications (refer also to the Premises Wiring diagram shown).

IMPORTANT: When the Ranger 9 is connected to a 230 volt, 3-wire line, the unit should be operated with the idler switch in the “HIGH” idle position to avoid load sensing problems. If the machine is set for automatic idle, the 230 volt circuit will sense loads and cause the engine to accelerate to high idle. However, since only one line of the circuit senses current, 115 volt power drawn from only one line to neutral may result in the engine not going to high idle.

1. Install the double pole, double throw switch between the power company meter and the premises disconnect.

Switch rating must be the same or greater than the customer's premises disconnect and service overcurrent protection.

Output Selector Setting	Welding Output	Permissible Power Watts (Unity Power Factor)	Permissible Auxiliary Current in Amperes @ 115V	Permissible Auxiliary Current in Amperes @ 230V
250	250	NONE		
200	200	2500	22	11
160	160	3700	32	16
120	120	5000	44	22
90	90	6000	52	26
45	45	7500	65	32.5
CV LOW	200	5000	43	21.5
	60	7500	65	32.5
CV MEDIUM	250	2750	40	20
	80	6500	56	28
CV HIGH	250	1200	10	5
	100	6000	52	26

2. Take necessary steps to assure load is limited to the capacity of the Ranger 9 by installing a 40 amp, 230 volt double pole circuit breaker. Maximum rated load for each leg of the 230 volt auxiliary is 40 amperes. Loading above 40 amps will reduce output voltage below the allowable - 10% of rated voltage which may damage appliances or other motor-driven equipment.
3. Install a 50 amp 115/230 volt plug (NEMA Type 14-50) to the Double Pole Circuit Breaker using No. 8, 4 conductor cable of the desired length. (The 50 amp 115/230 volt plug is available in the optional plug kit).
4. Plug this cable into the 50 amp 115/230 volt receptacle on the Ranger 9 case front.

CONNECTION OF RANGER 9 TO PREMISES WIRING

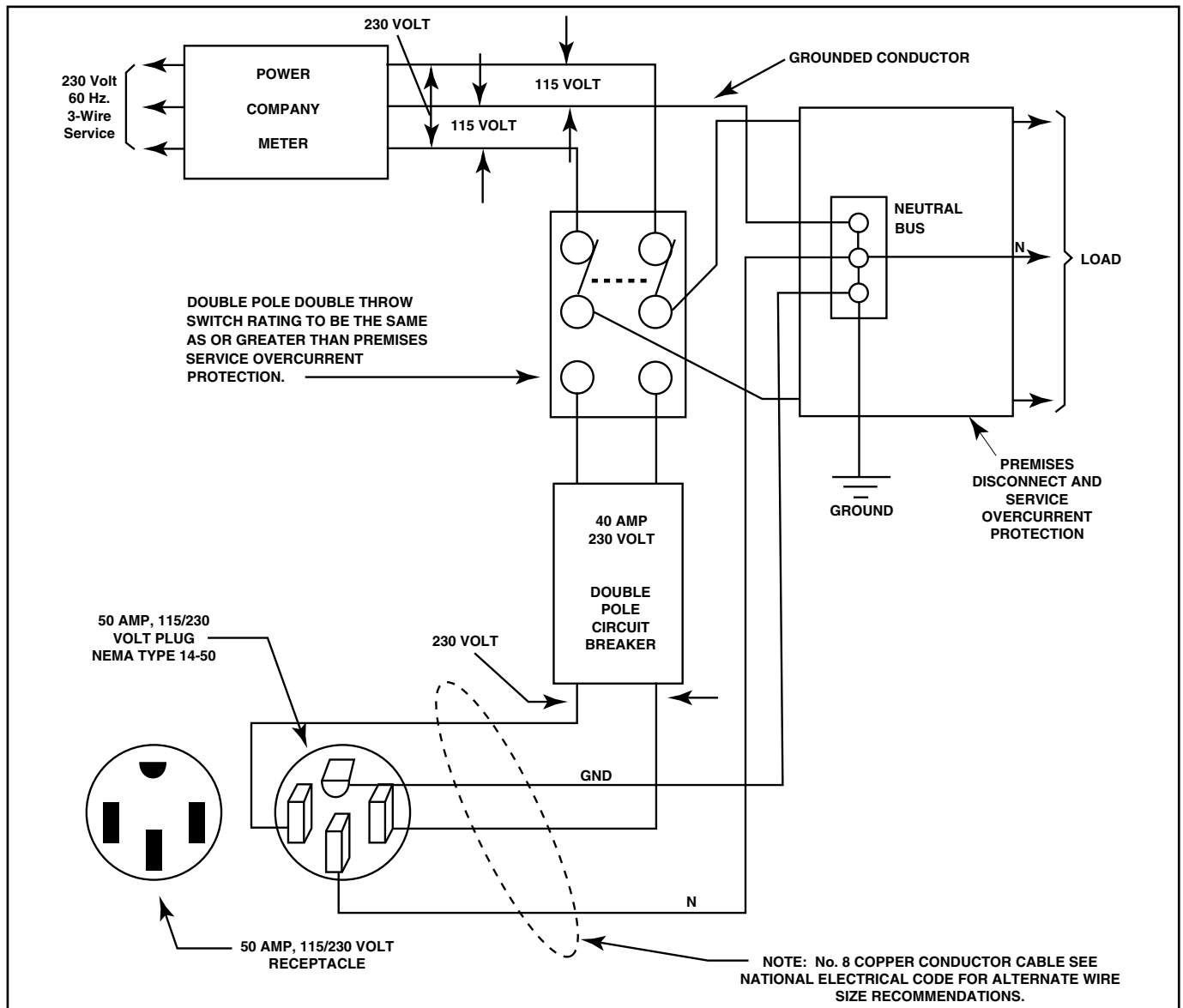

MAINTENANCE

Safety Precautions

WARNING

Have qualified personnel do the maintenance work. Turn the engine off before working inside the machine. In some cases, it may be necessary to remove safety guards to perform required maintenance. Remove guards only when necessary and replace them when the maintenance requiring their removal is complete. Always use the greatest care when working near moving parts.

Do not put your hands near the engine cooling blower fan. If a problem cannot be corrected by following the instructions, take the machine to the nearest Lincoln Field Service Shop.



ELECTRIC SHOCK can kill.

- Do not touch electrically live parts or electrode with skin or wet clothing.
- Insulate yourself from work and ground
- Always wear dry insulating gloves.



ENGINE EXHAUST can kill.

- Use in open, well ventilated areas or vent exhaust outside.



MOVING PARTS can injure.

- Do not operate with doors open or guards off.
- Stop engine before servicing.
- Keep away from moving parts.

See additional warning information at front of this operator's manual.

Engine Adjustments

WARNING

OVERSPEED IS HAZARDOUS

The maximum allowable high idle speed for this machine is 3750 RPM, no load. Do NOT tamper with governor components or setting or make any other adjustments to increase the maximum speed. Severe personal injury and damage to the machine can result if operated at speeds above maximum.

Adjustments to the engine are to be made only by a Lincoln Service Center or an authorized Field Service Shop.

Routine Maintenance

1. At the end of each day's use, refill the fuel tank to minimize moisture condensation in the tank. Running out of fuel tends to draw dirt into the fuel system. Also, check the crankcase oil level and add oil if indicated.
2. **OIL** - Maintenance schedule for changing the oil and oil filter after break-in:

	Kohler CH20S	Onan P218
Oil	100 hr	50 hr
Oil Filter	200 hr	100 hr

The above schedule is for normal operating conditions. More frequent oil changes are required with dusty, high temperature, and other severe operating conditions. Refer to the maintenance section of the Engine Owner's Manual for more information.

CAUTION

Engine life will be reduced if the oil and oil filter are not changed according to the manufacturer's recommendation.

3. **Air Cleaner** - With normal operating conditions, the maintenance schedule for cleaning and re-oiling the foam pre-filter is every 25 hours and replacement of the air cleaner filter every 100 hours. More frequent servicing is required with dusty operating conditions. Refer to maintenance section of the Engine Owner's Manual for more information.
4. Refer to the maintenance section of the Engine Owner's Manual for the maintenance schedule for spark plug servicing, cooling system servicing, and fuel filter replacement.

CAUTION

Make certain that the oil filler cap is securely tightened after checking or adding oil. If the cap is not tight, oil consumption can increase significantly which may be evidenced by white smoke coming from the exhaust.

5. Blow out the machine with low pressure air periodically. In particularly dirty locations, this may be required once per week.
6. Output Ranger Selector and Polarity Switches: Switch contacts should not be greased. To keep contacts clean, rotate the switch through its entire range frequently. Good practice is to turn the handle from maximum to minimum setting twice each morning before starting to weld.

Battery Charging

WARNING



GASES FROM BATTERY can explode.

- Keep sparks, flame and cigarettes away.

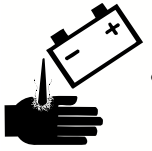

BATTERY ACID can burn eyes and skin.

- Wear gloves and eye protection and be careful when boosting, charging or working near battery.

To prevent **EXPLOSION** when:

- Installing a new battery - disconnect the negative cable from the old battery first and connect the negative cable to the new battery last.
- Connecting a battery charger - remove the battery from the welder by disconnecting the negative cable first, then the positive cable and battery clamp. When reinstalling, connect the negative cable last.
- Using a booster - connect the positive lead to the battery first, then connect the negative lead to the ground lead on the base.

To prevent **ELECTRICAL DAMAGE** when:

- Installing a new battery.
- Using a booster.

Use correct polarity - **Negative Ground**.

To prevent BATTERY DISCHARGE, if you have an ignition switch, turn it off when engine is not running.

- To prevent BATTERY BUCKLING, tighten nuts on battery clamp until snug.

- When replacing, jumping or otherwise connecting the battery to the battery cables, the proper polarity must be observed. Failure to observe the proper polarity could result in damage to the charging circuit. The positive (+) battery cable has a red terminal cover.
- If the battery requires charging from an external charger, disconnect the negative battery cable first and then the positive battery cable before attaching the charger leads. Failure to do so can result to damage to the internal charger components. When re-connecting the cables, connect the positive cable first and the negative cable last.

HARDWARE

Both English / Metric fasteners are used in this welder.

Engine Maintenance Parts

	ONAN P218	KOHLER CH20S
Oil Filter	ONAN 122-0645 FRAM PH3614	KOHLER 1205001 FRAM PH3614*
Air Filter Element	ONAN 140-2628-01 FRAM CA140PL	KOHLER 4708303 FRAM CA79
Air Filter Pre-Cleaner	ONAN 140-1496	KOHLER 2408302
Fuel Filter	ONAN 149-2005 FRAM G1	KOHLER 2505002 FRAM G1
Spark Plugs (Resistor Type)	ONAN 167-0263 CHAMPION RS14YC (.025" GAP)	CHAMPION RC12YC (.030" GAP)

* Oil capacity increases from 2.0 Qts. to 2.1 Qts. when using this filter.

TROUBLESHOOTING

ENGINE

TROUBLE	CAUSE	WHAT TO DO
A. Engine will not crank or is hard to crank.	<ol style="list-style-type: none"> 1. Battery will not hold a charge. Faulty battery. 2. No or insufficient charging current. 3. Loose battery cable connection(s). 4. Lead #216A from solenoid to start switch broken. 5. Spark plugs fouled. 	<ol style="list-style-type: none"> 1. Replace with known good one. 2. Check connection of lead from voltage regulator on engine to charging ammeter and battery lead #208 and #209. 3. Check and tighten connection at battery, at starter, at engine foot, or at frame. 4. Repair. 5. Replace spark plugs.
B. Engine will not start or shuts down.	<ol style="list-style-type: none"> 1. Low oil pressure. 2. Out of fuel. 3. Fault in fuel system. 4. #216 lead from start switch to P.C. board broke / (Onan engine). 5. Oil pressure switch faulty. 6. Generator terminal block connection faulty. 7. Faulty P.C. Board (Onan engine). 	<ol style="list-style-type: none"> 1. Check oil level and add oil as req'd. 2. Add fuel to tank. 3. Repair. 4. Repair. 5. Replace 6. Repair. Check leads #208, 224A, 224B, 212. 7. Replace.
C. Engine does not develop full power.	<ol style="list-style-type: none"> 1. Fuel filter clogged. 2. Air filter clogged. 	<ol style="list-style-type: none"> 1. Replace. 2. Replace.
D. Battery does not stay charged.	<ol style="list-style-type: none"> 1. Faulty battery. 2. Faulty charging system. 3. Loose or broken lead in charging circuit. 	<ol style="list-style-type: none"> 1. Replace with a new battery. 2. Refer to Engine Operators Manual for charging system service. 3. Refer to wiring diagram and check related leads, especially #208 and #209 leads.

IDLER SYSTEM

TROUBLE	CAUSE	WHAT TO DO
<p>A. Engine will not idle down to low speed.</p>	<ol style="list-style-type: none"> 1. Idler switch in "HIGH" idle position. 2. External load on welder or auxiliary power. 3. Mechanical problem in idler solenoid linkage. 4. Idler solenoid position out of adjustment. 5. Faulty wiring in solenoid circuit. 6. Contactor circuit #2 or #4 closed or shorted. Engine goes to high idle when contactor circuit closes. 7. Faulty idler solenoid. 8. Low voltage at 224D to ground stud. (Voltage should be 12-14V DC). 9. Faulty P.C. Board PCB1. 	<ol style="list-style-type: none"> 1. Set switch to "AUTO" position. 2. Remove all external loads. 3. Repair. 4. Adjust solenoid as necessary. 5. Check for broken leads #224D, 214. 6. Refer to wiring diagram. Check related leads and amphenol connectors. 7. Replace with known good one. 8. Check wiring, battery and battery charging circuits. 9. Replace P.C. Board with known good one.
<p>B. Engine will not go to high idle when attempting to weld.</p> <p>I. Scratch Start</p> <p>II. When using wire feeder with control cable plugged into amphenol connector or using amptrol when trigger is depressed.</p>	<ol style="list-style-type: none"> 1. Poor work lead connection to work. 2. "WELDING TERMINALS" switch in wrong position. 3. No open circuit voltage on output studs. 4. Faulty P.C. Board PCB1. 1. "WELDING TERMINALS" switch in wrong position. 2. Faulty wiring. 	<ol style="list-style-type: none"> 1. Make sure work clamp is tightly connected to clean base metal. 2. Switch must be in "ALWAYS ON" position to scratch start. 3. Check leads #247 and #250 for breaks. Check Switch S6 for faults. 4. Replace P.C. Board with known good one. 1. Switch must be in "REMOTELY CONTROLLED" position. 2. Refer to schematic. Check wiring in #2 and #4 circuit.
<p>C. Engine will not go to high idle when using auxiliary power.</p>	<ol style="list-style-type: none"> 1. No signal from current sensor. 2. Auxiliary power lead less than 100 watts. 3. Faulty idler P.C. Board 	<ol style="list-style-type: none"> 1. Check for broken leads in idler sensing circuit. #3 lead. 2. Idler may not respond with less than 100 watt load. Set idler switch to high idle. 3. Replace P.C. Board with known good one.

OUTPUT SYSTEM

TROUBLE	CAUSE	WHAT TO DO
A. No welder or power output.	<ol style="list-style-type: none"> 1. Open lead in flashing or field circuit. 2. Faulty rotor. 3. Faulty stator field. 4. Faulty field rectifier D2. 5. Output contactor does not pull in. 6. Faulty P.C. Board. 	<ol style="list-style-type: none"> 1. Refer to wiring diagram and check related leads. (#7 & #9; #200, #201 and #219) 2. Lift brushes and check rotor continuity between slip rings. (Should be approx. 7.3Ω) 3. Disconnect lead #7 at D2 and check for continuity between leads #7 and #9. 4. Replace with known good one. 5. Refer to wiring diagram and check related leads and contactor. 6. Replace P.C. Board with known good one.
B. Output control on welder not functioning.	<ol style="list-style-type: none"> 1. Output control switch in wrong position. 2. Output control switch defective. 3. Output control potentiometer defective. 4. Faulty wiring. 5. Faulty P.C. Board 	<ol style="list-style-type: none"> 1. Place switch in "Output Control at Welder". 2. Check and replace switch if faulty. 3. Check and replace potentiometer if faulty. 4. Check for broken leads #75, #76, and #77 from P.C. Board and #75A, #76D, and #77D from potentiometer to remote switch. 5. Replace P.C. Board with known good one.
C. Output control or remote not functioning.	<ol style="list-style-type: none"> 1. Output control switch in wrong position. 2. Leads #75, #76, #77 broken at P.C. Board or S4. 3. Leads #75A, #76A, #77A broken at S4 or amphenol. 4. Remote control leads broken in control cable. 5. Faulty wire feeder. 6. Faulty P.C. Board. 	<ol style="list-style-type: none"> 1. Place switch in "Remote" position. 2. Repair. 3. Repair. 4. Repair. 5. Replace wire feeder with known good one. 6. Replace P.C. Board with known good one.
D. Wire feeder does not work when connected to welder amphenol.	<ol style="list-style-type: none"> 1. Wire feeder circuit breaker open or faulty. 2. Broken #31, #32, or #42 lead at amphenol. 3. No 115V or 42V output from stator. 4. Faulty wiring in control cable. 5. Faulty wire feeder. 	<ol style="list-style-type: none"> 1. Reset or replace. 2. Repair. 3. Check continuity on #31, #32, and #42 at stator. Check buildup. If O.K. , stator may be faulty. Replace. 4. Repair or replace cable. 5. Replace P.C. Board with known good one.

OUTPUT SYSTEM

TROUBLE	CAUSE	WHAT TO DO
E. Contactor does not pull in when scratch starting when engine goes to high idle.	<ol style="list-style-type: none"> 1. Welding terminal switch in wrong position. 2. Faulty wiring in contactor circuit. 3. Faulty remote switch S6. 4. Faulty contactor. 5. Faulty P.C. Board PCB1. 	<ol style="list-style-type: none"> 1. Place switch S6 in "Always On" position. 2. Check for broken leads #224C, #232A, and #224. 3. Check switch and leads #247, and #250. 4. Replace contactor with known good one. 5. Replace P.C. Board with known good one.
F. Contactor does not pull in when using a wire feeder with a control cable plugged into amphenol.	<ol style="list-style-type: none"> 1. "WELDING TERMINALS" switch in wrong position. 2. Faulty wiring in contactor circuit. 3. Faulty amphenol or bypass P.C. Board PCB2. 4. Faulty contactor. 5. Faulty P.C. Board PCB1. 6. Faulty control cable from wire feeder or amphenol. 7. Faulty wire feeder. 	<ol style="list-style-type: none"> 1. Place switch S6 in "REMOTELY CONTROLLED" position. 2. Check for broken leads #224, #224C & #232A. 3. Refer to wiring diagram and check related leads (#2 and #4). 4. Replace contactor with known good one. 5. Replace P.C. Board with known good one. 6. Replace. 7. Repair or replace.
G. Contactor does not drop out.	<ol style="list-style-type: none"> 1. Faulty wiring. 2. Faulty amphenol or bypass P.C. Board PCB2. 3. Faulty contactor. 4. Faulty P.C. Board PCB1. 	<ol style="list-style-type: none"> 1. Check that lead #232 is not grounded. 2. Look for shorts to ground. Repair or replace. 3. Replace with known good one. 4. Replace with known good one.

RANGER 9 (ONAN) - WIRING DIAGRAM - CODE 10378 & 10539

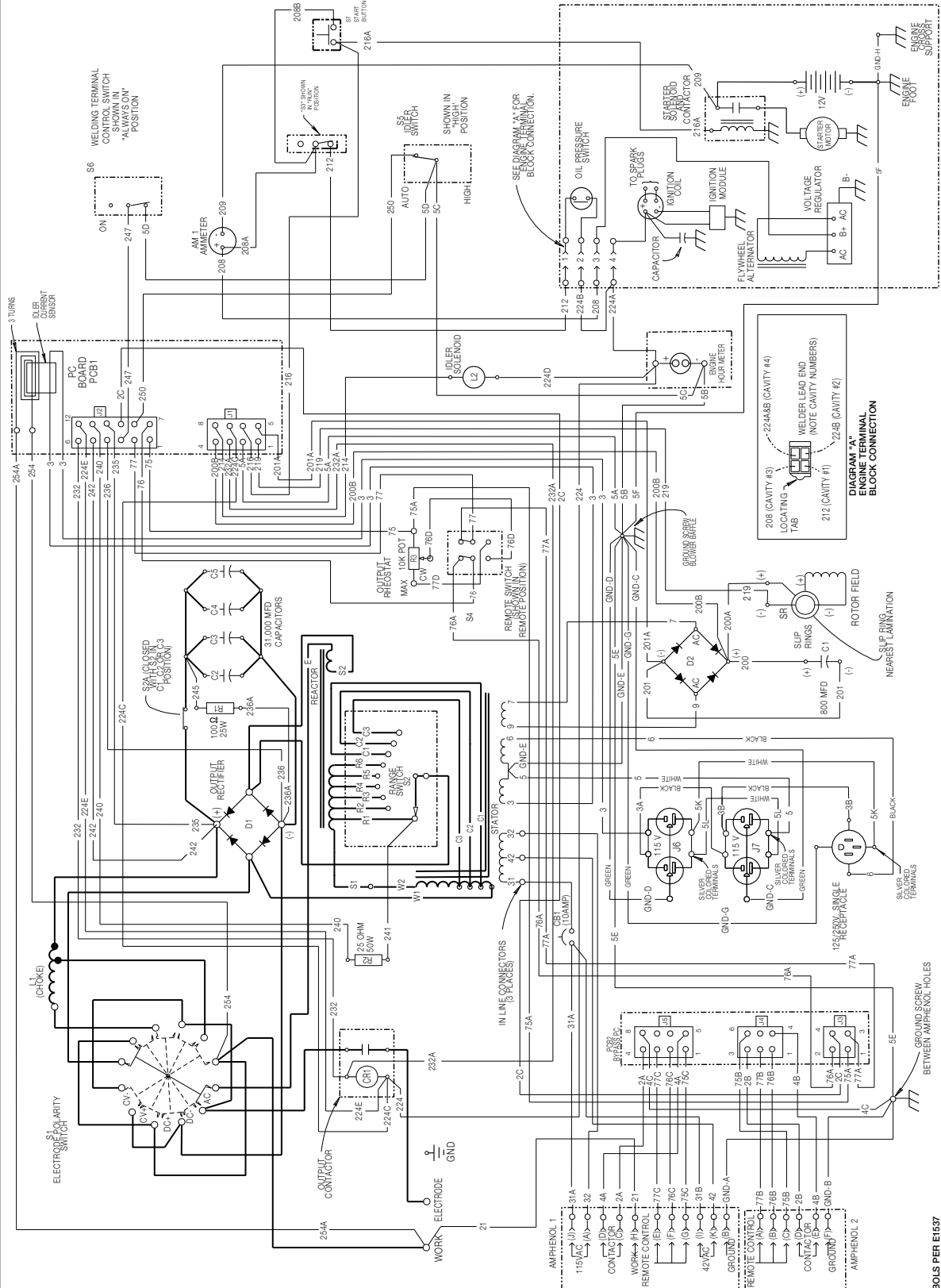

7-19-96G

L10248

NOTE: This diagram is for reference only. It may not be accurate for all machines covered by this manual. The specific diagram for a particular code is pasted inside the machine on one of the enclosure panels. If the diagram is illegible, write to the Service Department for a replacement. Give the equipment code number.

RANGER 9 ONAN (CSA VERSION) - WIRING DIAGRAM - CODE 10379 & 10540

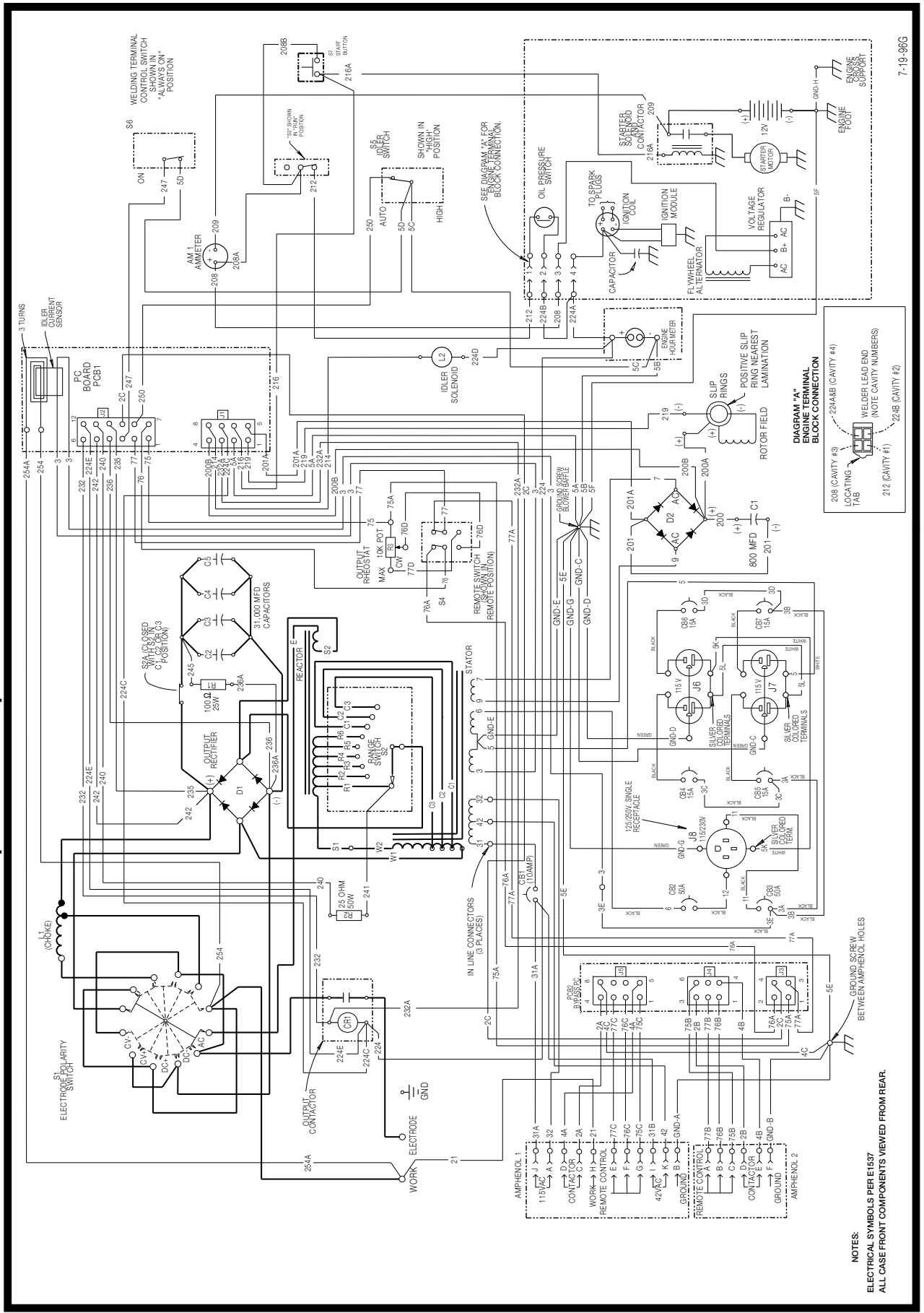

7-19-96G
L10249

NOTE: This diagram is for reference only. It may not be accurate for all machines covered by this manual. The specific diagram for a particular code is pasted inside the machine on one of the enclosure panels. If the diagram is illegible, write to the Service Department for a replacement. Give the equipment code number.

RANGER 9 KOHLER (CSA VERSION) - WIRING DIAGRAM - CODE 10550

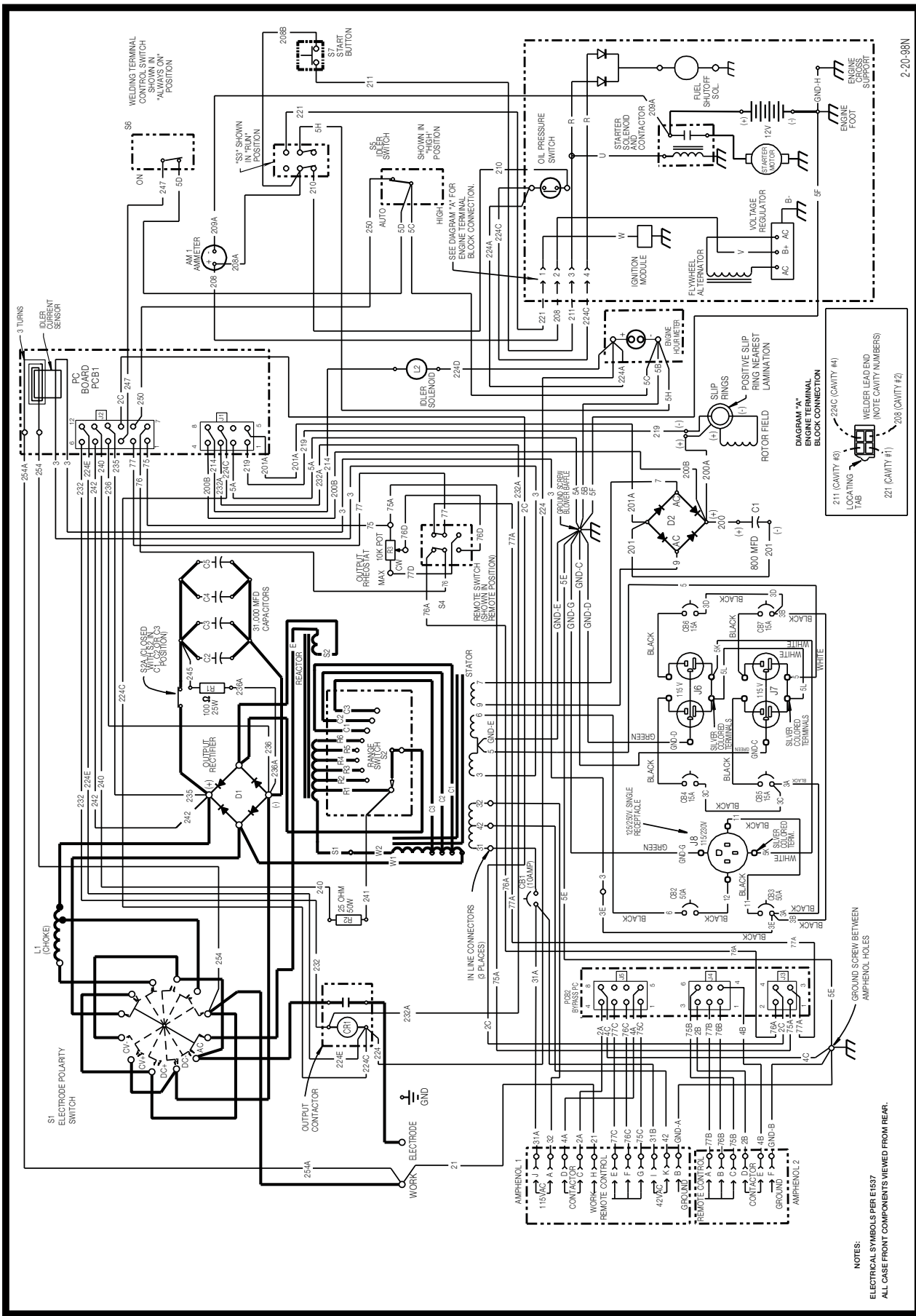

NOTE: This diagram is for reference only. It may not be accurate for all machines covered by this manual. The specific diagram for a particular code is pasted inside the machine on one of the enclosure panels. If the diagram is illegible, write to the Service Department for a replacement. Give the equipment code number.

RANGER 9 / LN-25 ACROSS THE ARC CONNECTION DIAGRAM

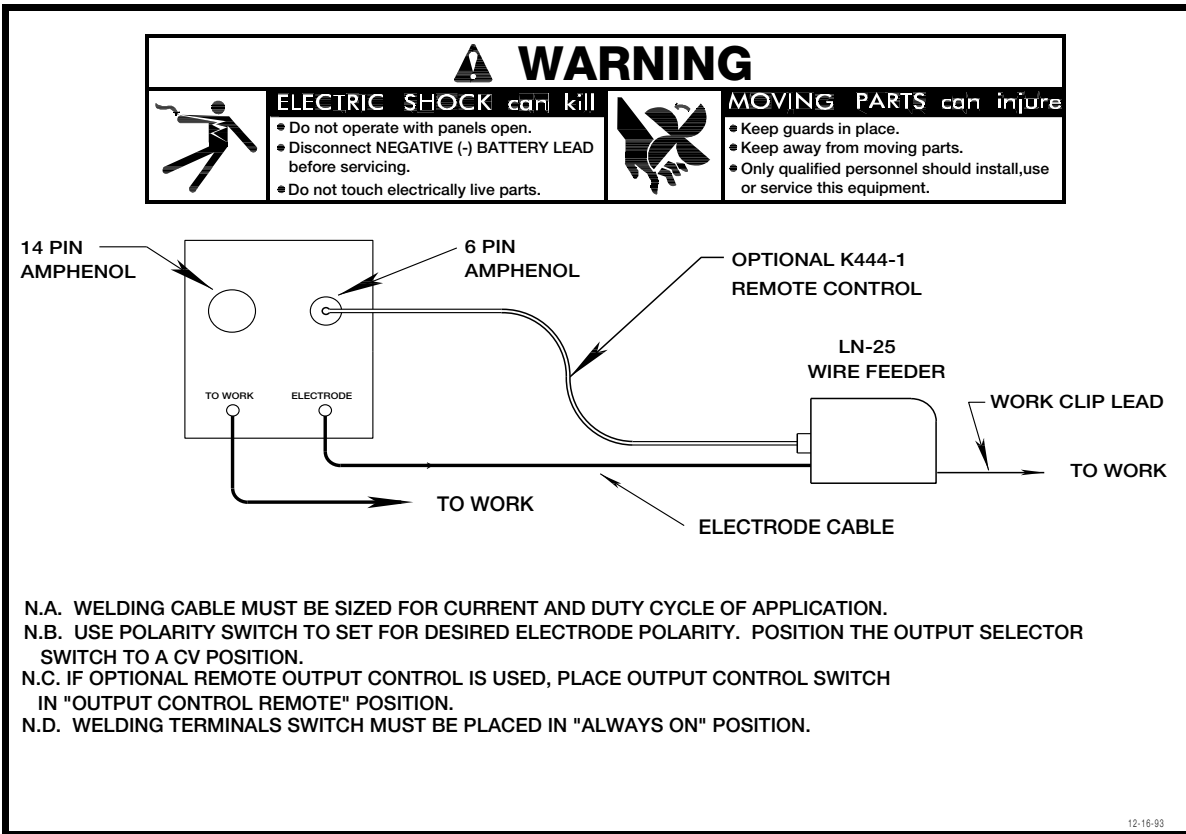

RANGER 9 / K867 / K775 / LN-7 CONNECTION DIAGRAM

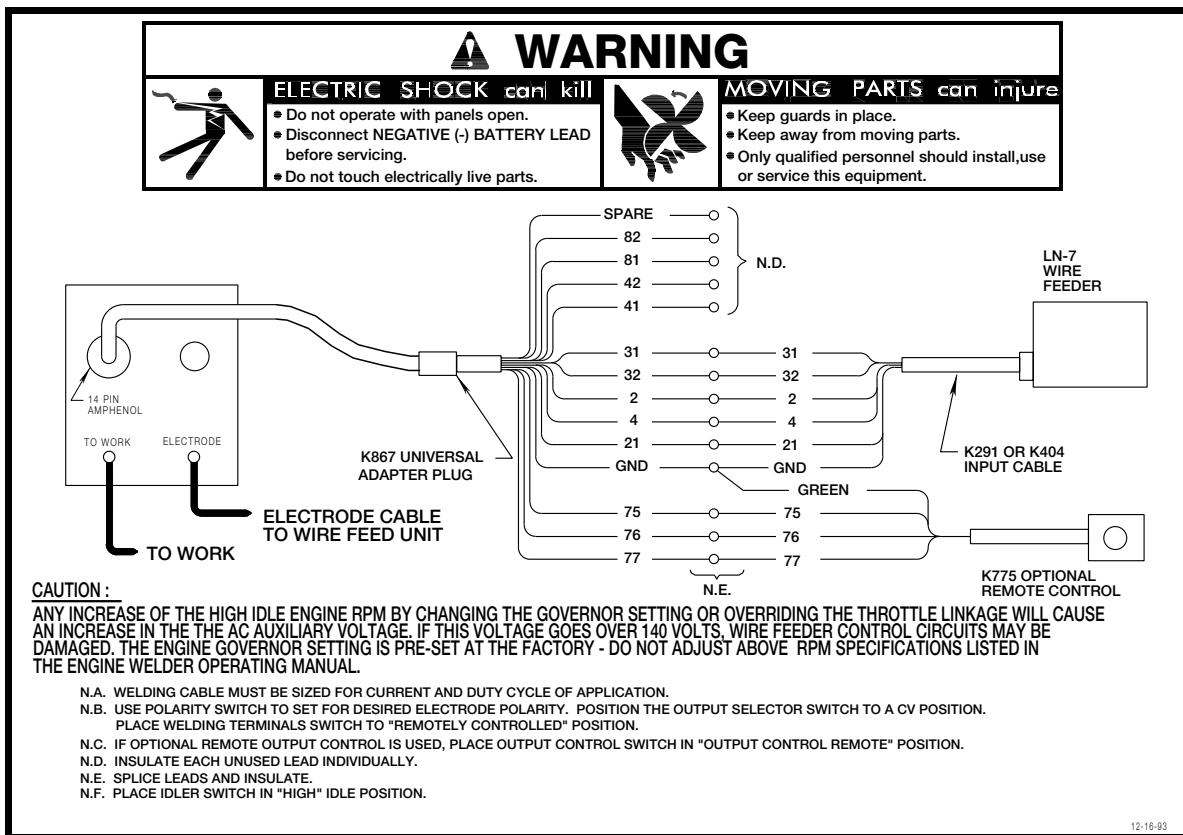

RANGER 9 / LN-7 CONNECTION DIAGRAM

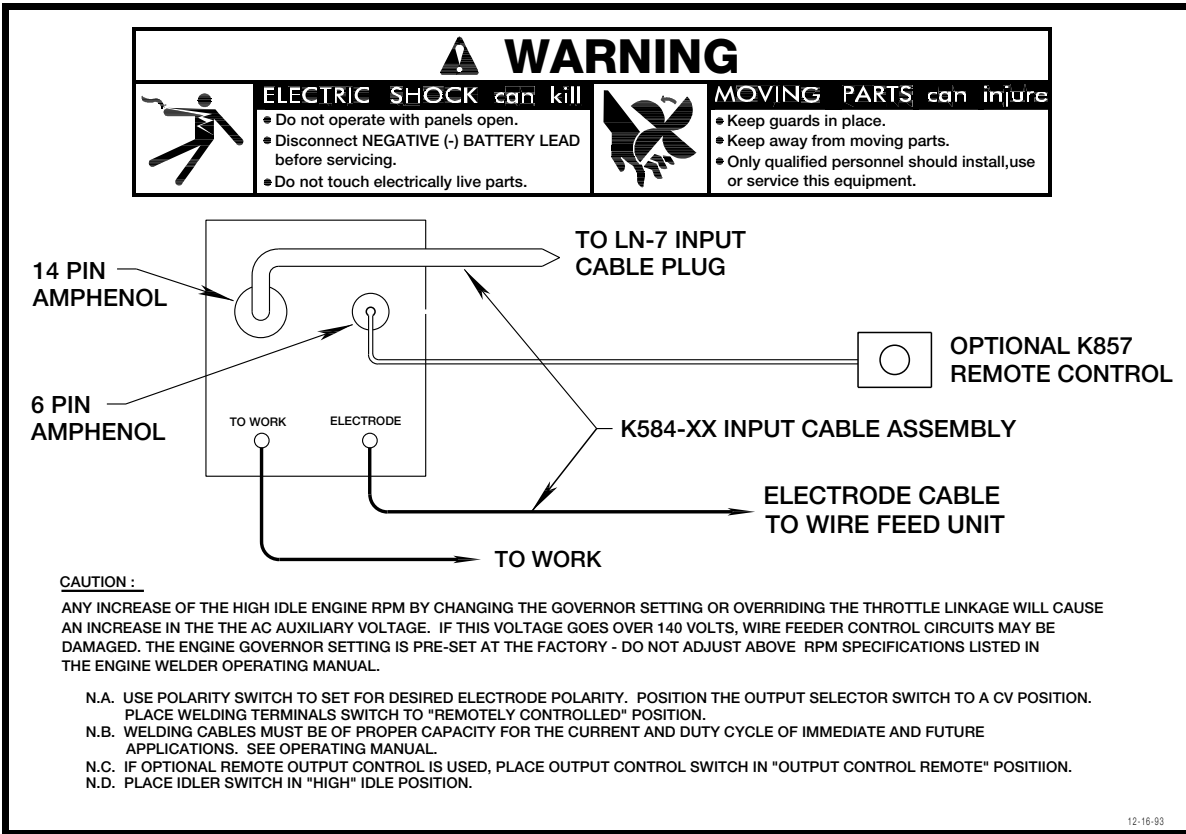

RANGER 9 TO K867 ADAPTER CONNECTION DIAGRAM

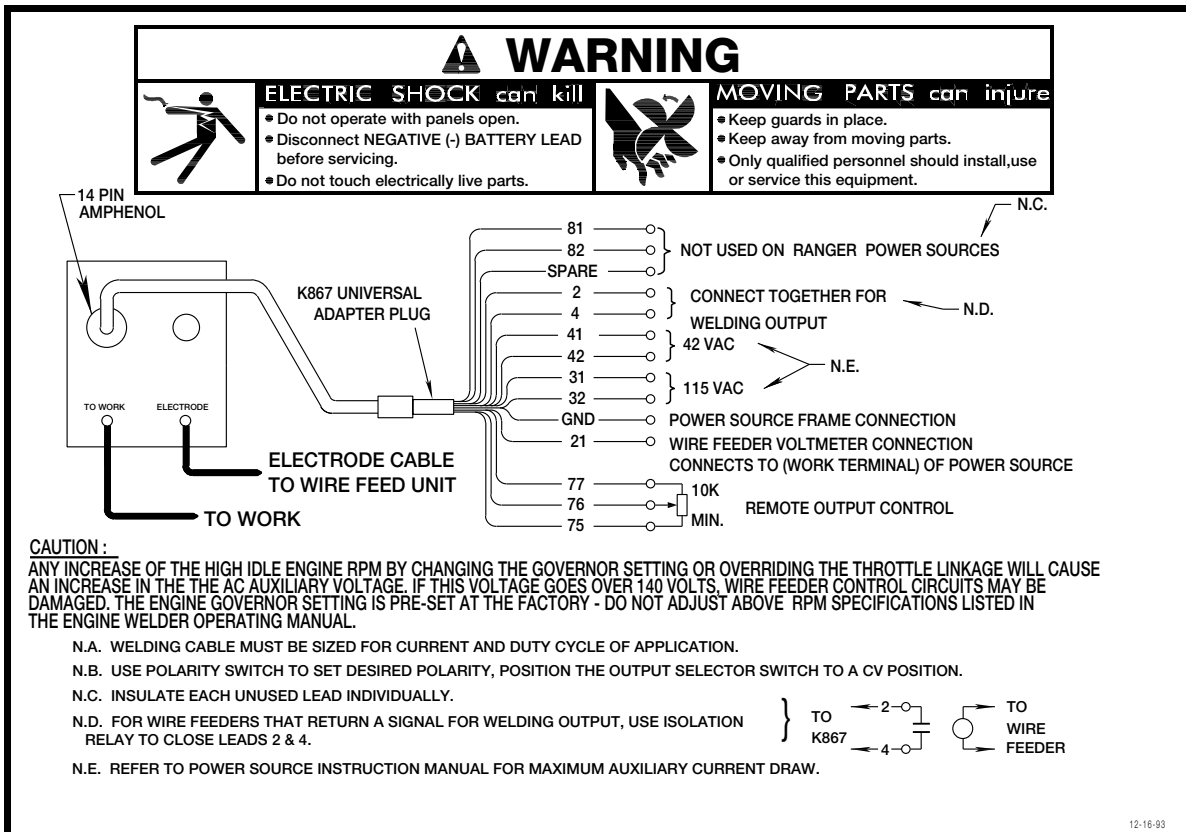

RANGER 9 / K867 / LN-8 CONNECTION DIAGRAM

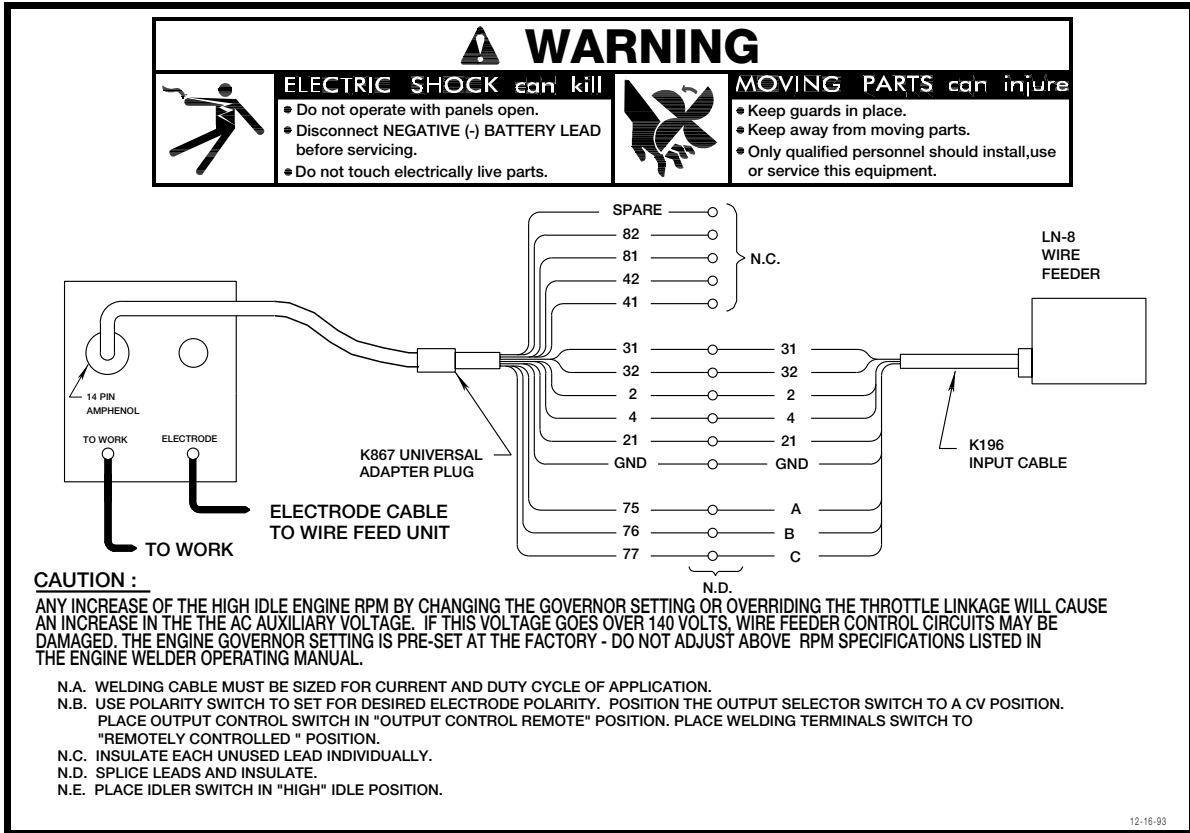

RANGER 9 / LN-742 CONNECTION DIAGRAM

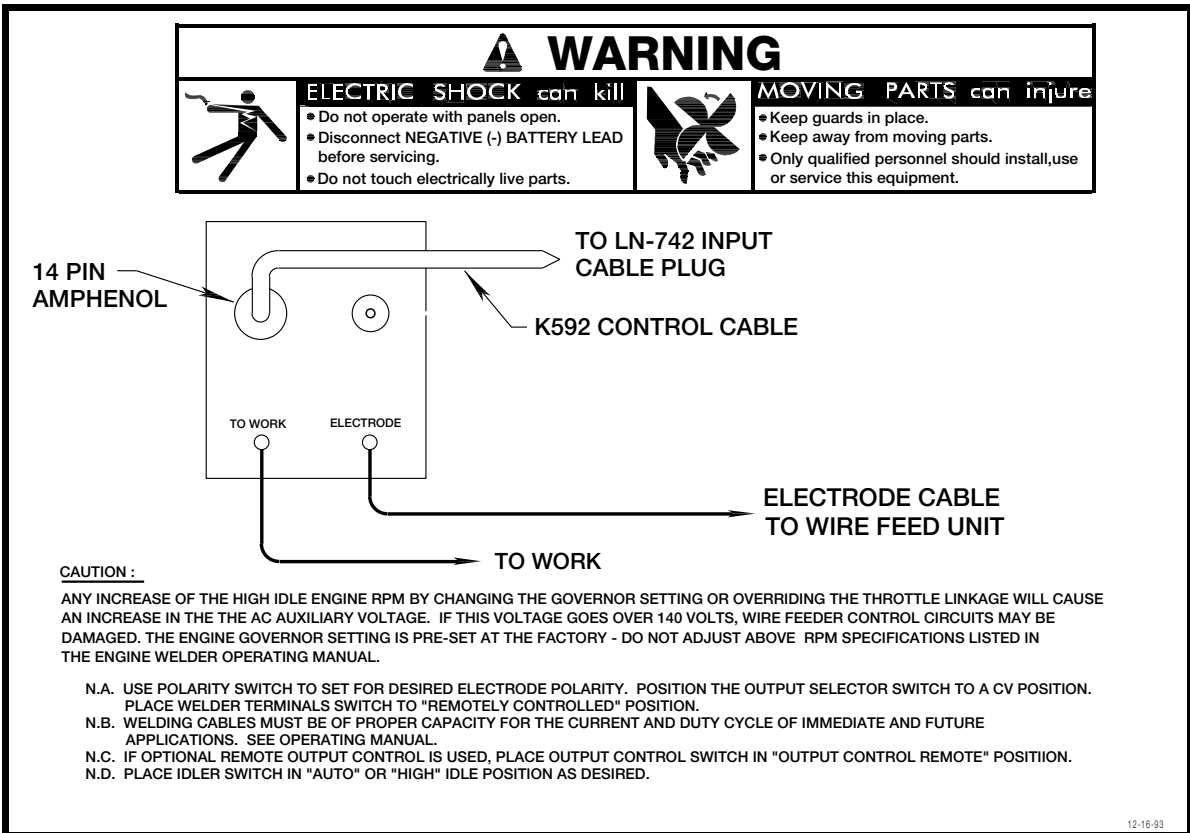

**RANGER 9 / LN-25 WITH 42 VOLT REMOTE OUTPUT
CONTROL MODULE CONNECTION DIAGRAM**

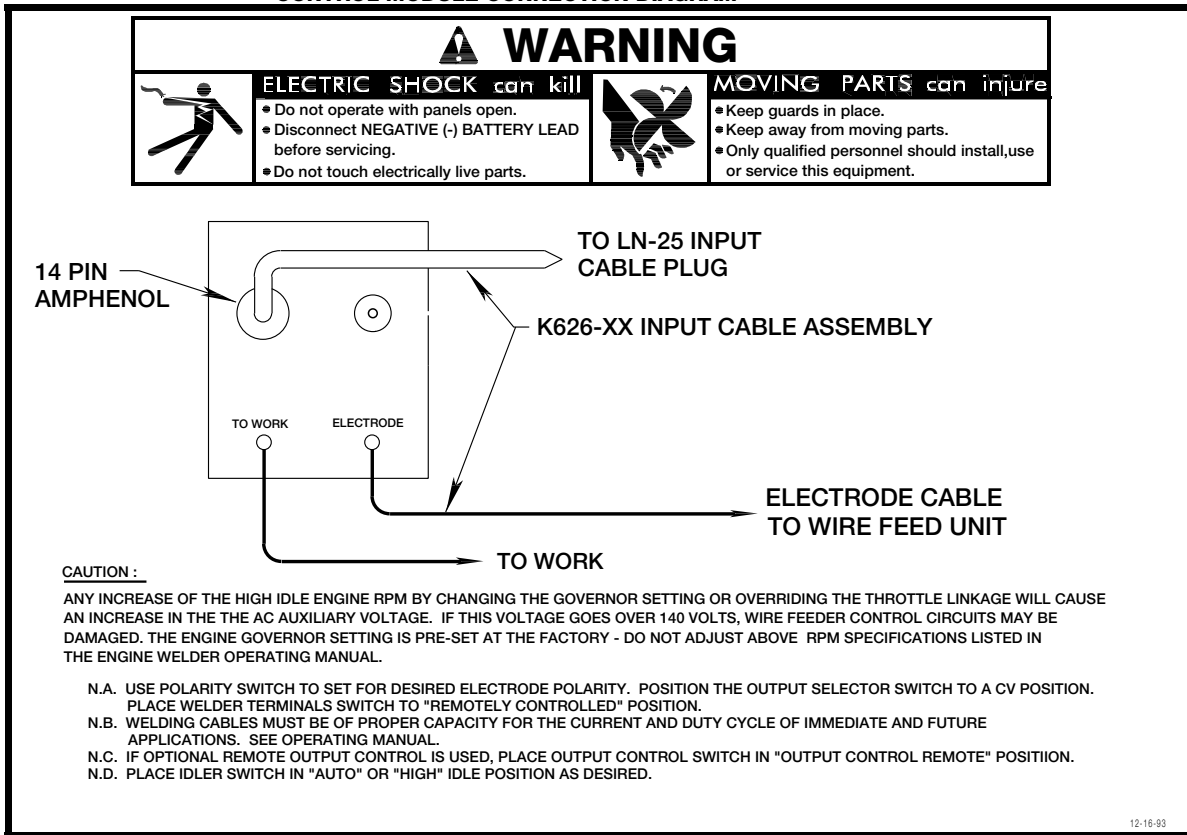

12-16-03
M17214

K915-1 AMPCTRL ADAPTER FOR K799 HI-FREQ KITS

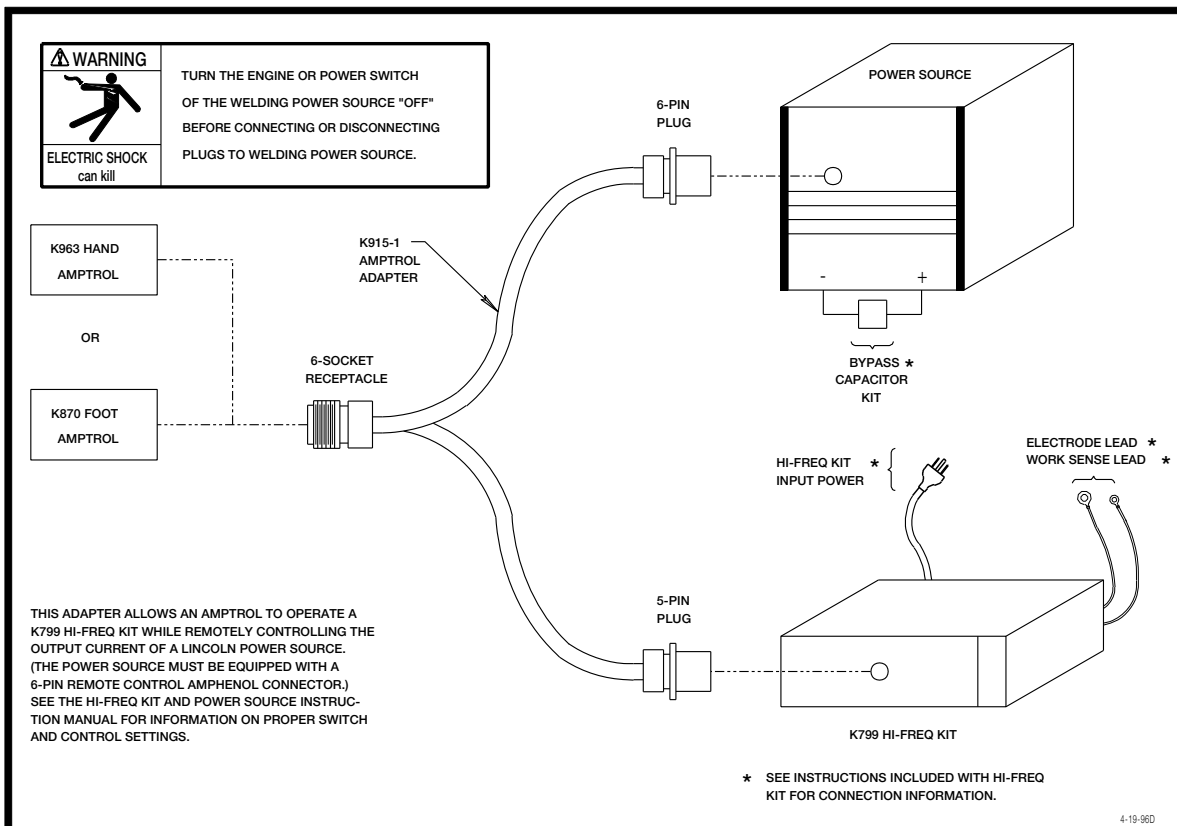

RANGER 9 AND 10LX / K691-10 / K488 / K487 SPOOL GUN CONNECTION DIAGRAM

⚠ WARNING		
	ELECTRIC SHOCK can kill <ul style="list-style-type: none"> • Do not operate with panels open. • Disconnect NEGATIVE (-) BATTERY LEAD before servicing. • Do not touch electrically live parts. 	
		MOVING PARTS can injure <ul style="list-style-type: none"> • Keep guards in place. • Keep away from moving parts. • Only qualified personnel should install, use or service this equipment.



CAUTION : BE SURE THAT CONTROL MODULE MODE SLIDE SWITCH IS IN THE "LINCOLN" (CONTACT CLOSURE) POSITION BEFORE ATTEMPTING TO OPERATE CONTROL MODULE. INCORRECT SWITCH POSITION COULD RESULT IN DAMAGE TO THE CONTROL MODULE AND/OR POWER SOURCE.

ANY INCREASE OF THE HIGH IDLE ENGINE RPM BY CHANGING THE GOVERNOR SETTING OR OVERRIDING THE THROTTLE LINKAGE WILL CAUSE AN INCREASE IN THE THE AC AUXILIARY VOLTAGE. IF THIS VOLTAGE GOES OVER 140 VOLTS, WIRE FEEDER CONTROL CIRCUITS MAY BE DAMAGED. THE ENGINE GOVERNOR SETTING IS PRE-SET AT THE FACTORY - DO NOT ADJUST ABOVE RPM SPECIFICATIONS LISTED IN THE ENGINE WELDER OPERATING MANUAL.

- N.A. WELDING CABLE MUST BE SIZED FOR CURRENT AND DUTY CYCLE OF APPLICATION.
- N.B. USE POLARITY SWITCH TO SET FOR DESIRED ELECTRODE POLARITY. POSITION THE OUTPUT SELECTOR SWITCH TO A CV POSITION. PLACE WELDING TERMINALS SWITCH TO "REMOTELY CONTROLLED" POSITION.
- N.C. IF OPTIONAL K857 REMOTE OUTPUT CONTROL IS CONNECTED TO 6 PIN RECEPTACLE, PLACE OUTPUT CONTROL SWITCH IN "OUTPUT CONTROL REMOTE" POSITION.
- N.D. PLACE IDLER SWITCH IN "HIGH" IDLE POSITION.

CRM23615
M17902

DIMENSION PRINT - Ranger 9

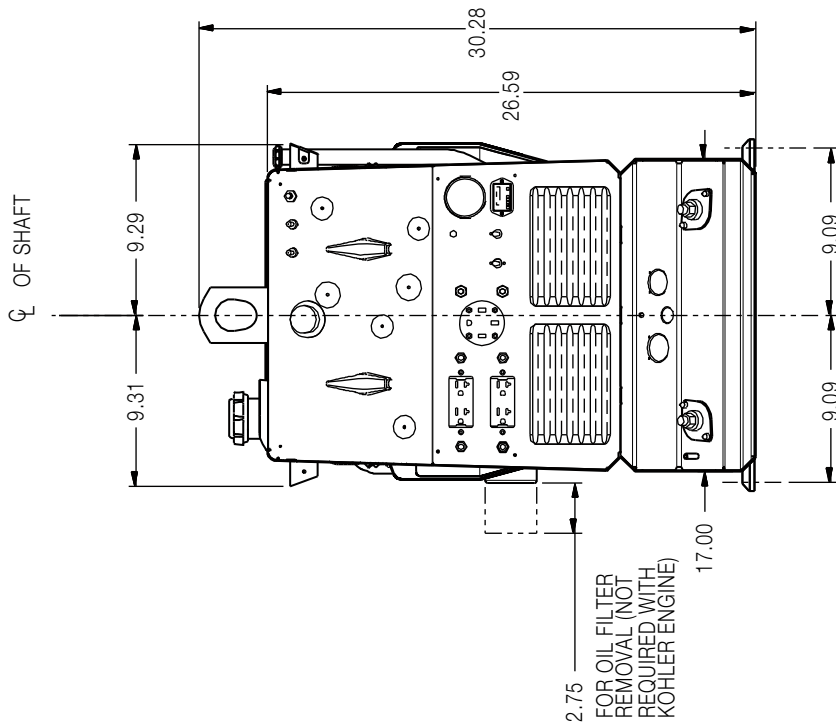
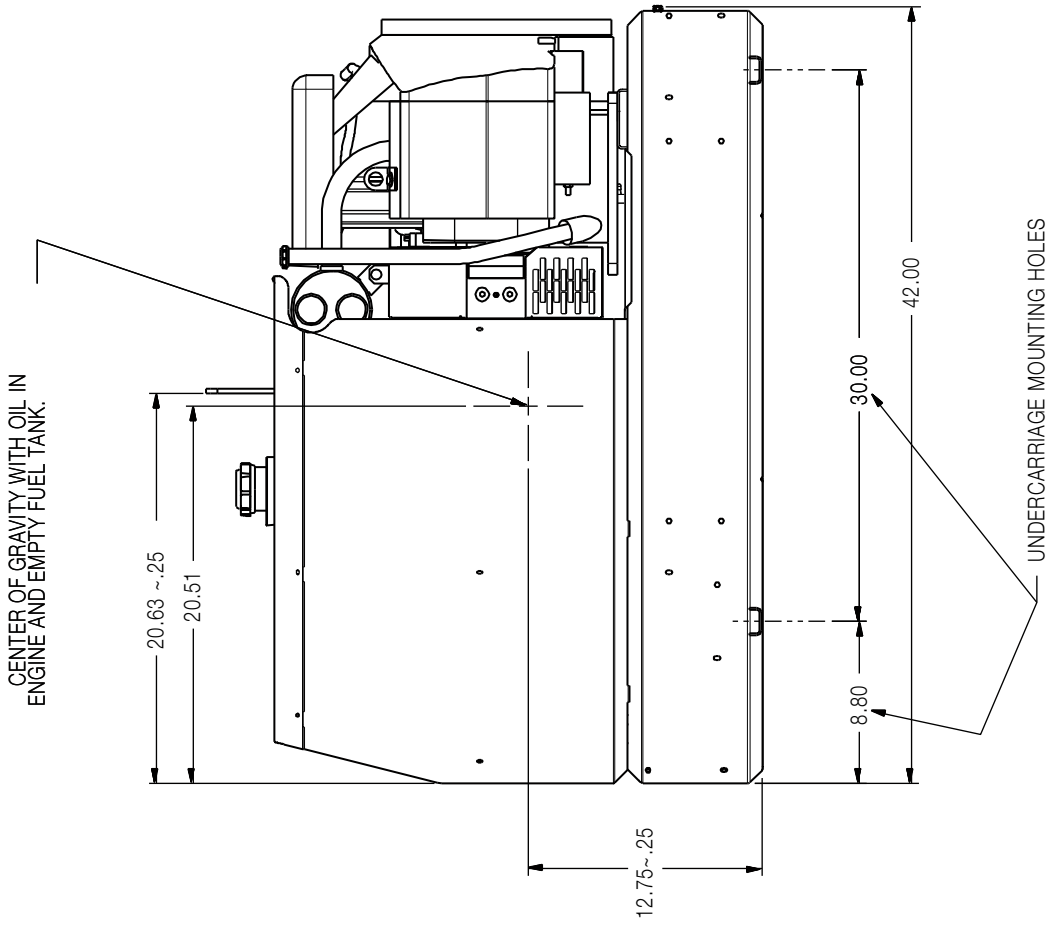

			
WARNING	<ul style="list-style-type: none"> ● Do not touch electrically live parts or electrode with skin or wet clothing. ● Insulate yourself from work and ground. 	<ul style="list-style-type: none"> ● Keep flammable materials away. 	<ul style="list-style-type: none"> ● Wear eye, ear and body protection.
Spanish AVISO DE PRECAUCION	<ul style="list-style-type: none"> ● No toque las partes o los electrodos bajo carga con la piel o ropa mojada. ● Aislese del trabajo y de la tierra. 	<ul style="list-style-type: none"> ● Mantenga el material combustible fuera del área de trabajo. 	<ul style="list-style-type: none"> ● Protéjase los ojos, los oídos y el cuerpo.
French ATTENTION	<ul style="list-style-type: none"> ● Ne laissez ni la peau ni des vêtements mouillés entrer en contact avec des pièces sous tension. ● Isolez-vous du travail et de la terre. 	<ul style="list-style-type: none"> ● Gardez à l'écart de tout matériel inflammable. 	<ul style="list-style-type: none"> ● Protégez vos yeux, vos oreilles et votre corps.
German WARNUNG	<ul style="list-style-type: none"> ● Berühren Sie keine stromführenden Teile oder Elektroden mit Ihrem Körper oder feuchter Kleidung! ● Isolieren Sie sich von den Elektroden und dem Erdboden! 	<ul style="list-style-type: none"> ● Entfernen Sie brennbares Material! 	<ul style="list-style-type: none"> ● Tragen Sie Augen-, Ohren- und Körperschutz!
Portuguese ATENÇÃO	<ul style="list-style-type: none"> ● Não toque partes elétricas e electrodos com a pele ou roupa molhada. ● Isole-se da peça e terra. 	<ul style="list-style-type: none"> ● Mantenha inflamáveis bem guardados. 	<ul style="list-style-type: none"> ● Use proteção para a vista, ouvido e corpo.
Japanese 注意事項	<ul style="list-style-type: none"> ● 通電中の電気部品、又は溶材にヒフやぬれた布で触れないこと。 ● 施工物やアースから身体が絶縁されている様にして下さい。 	<ul style="list-style-type: none"> ● 燃えやすいものの側での溶接作業は絶対にしてはなりません。 	<ul style="list-style-type: none"> ● 目、耳及び身体に保護具をして下さい。
Chinese 警告	<ul style="list-style-type: none"> ● 皮膚或濕衣物切勿接觸帶電部件及鎘條。 ● 使你自已與地面和工件絕緣。 	<ul style="list-style-type: none"> ● 把一切易燃物品移離工作場所。 	<ul style="list-style-type: none"> ● 佩戴眼、耳及身體勞動保護用具。
Korean 위험	<ul style="list-style-type: none"> ● 전도체나 용접봉을 젖은 헝겍 또는 피부로 절대 접촉치 마십시오. ● 모재와 접지를 접촉치 마십시오. 	<ul style="list-style-type: none"> ● 인화성 물질을 접근시키지 마십시오. 	<ul style="list-style-type: none"> ● 눈, 귀와 몸에 보호장구를 착용하십시오.
Arabic تحذير	<ul style="list-style-type: none"> ● لا تلمس الاجزاء التي يسري فيها التيار الكهربائي أو الألكترود بجلد الجسم أو بالملابس المبللة بالماء. ● ضع عازلا على جسمك خلال العمل. 	<ul style="list-style-type: none"> ● ضع المواد القابلة للاشتعال في مكان بعيد. 	<ul style="list-style-type: none"> ● ضع أدوات وملابس واقية على عينيك وأذنيك وجسمك.

READ AND UNDERSTAND THE MANUFACTURER'S INSTRUCTION FOR THIS EQUIPMENT AND THE CONSUMABLES TO BE USED AND FOLLOW YOUR EMPLOYER'S SAFETY PRACTICES.

SE RECOMIENDA LEER Y ENTENDER LAS INSTRUCCIONES DEL FABRICANTE PARA EL USO DE ESTE EQUIPO Y LOS CONSUMIBLES QUE VA A UTILIZAR, SIGA LAS MEDIDAS DE SEGURIDAD DE SU SUPERVISOR.

LISEZ ET COMPRENEZ LES INSTRUCTIONS DU FABRICANT EN CE QUI REGARDE CET EQUIPMENT ET LES PRODUITS A ETRE EMPLOYES ET SUIVEZ LES PROCEDURES DE SECURITE DE VOTRE EMPLOYEUR.

LESEN SIE UND BEFOLGEN SIE DIE BETRIEBSANLEITUNG DER ANLAGE UND DEN ELEKTRODENEINSATZ DES HERSTELLERS. DIE UNFALLVERHÜTUNGSVORSCHRIFTEN DES ARBEITGEBERS SIND EBENFALLS ZU BEACHTEN.

			
<ul style="list-style-type: none"> ● Keep your head out of fumes. ● Use ventilation or exhaust to remove fumes from breathing zone. 	<ul style="list-style-type: none"> ● Turn power off before servicing. 	<ul style="list-style-type: none"> ● Do not operate with panel open or guards off. 	WARNING
<ul style="list-style-type: none"> ● Los humos fuera de la zona de respiración. ● Mantenga la cabeza fuera de los humos. Utilice ventilación o aspiración para gases. 	<ul style="list-style-type: none"> ● Desconectar el cable de alimentación de poder de la máquina antes de iniciar cualquier servicio. 	<ul style="list-style-type: none"> ● No operar con panel abierto o guardas quitadas. 	Spanish AVISO DE PRECAUCION
<ul style="list-style-type: none"> ● Gardez la tête à l'écart des fumées. ● Utilisez un ventilateur ou un aspirateur pour ôter les fumées des zones de travail. 	<ul style="list-style-type: none"> ● Débranchez le courant avant l'entretien. 	<ul style="list-style-type: none"> ● N'opérez pas avec les panneaux ouverts ou avec les dispositifs de protection enlevés. 	French ATTENTION
<ul style="list-style-type: none"> ● Vermeiden Sie das Einatmen von Schweißrauch! ● Sorgen Sie für gute Be- und Entlüftung des Arbeitsplatzes! 	<ul style="list-style-type: none"> ● Strom vor Wartungsarbeiten abschalten! (Netzstrom völlig öffnen; Maschine anhalten!) 	<ul style="list-style-type: none"> ● Anlage nie ohne Schutzgehäuse oder Innenschutzverkleidung in Betrieb setzen! 	German WARNUNG
<ul style="list-style-type: none"> ● Mantenha seu rosto da fumaça. ● Use ventilação e exaustão para remover fumo da zona respiratória. 	<ul style="list-style-type: none"> ● Não opere com as tampas removidas. ● Desligue a corrente antes de fazer serviço. ● Não toque as partes elétricas nuas. 	<ul style="list-style-type: none"> ● Mantenha-se afastado das partes moventes. ● Não opere com os painéis abertos ou guardas removidas. 	Portuguese ATENÇÃO
<ul style="list-style-type: none"> ● ヒュームから頭を離すようにして下さい。 ● 換気や排煙に十分留意して下さい。 	<ul style="list-style-type: none"> ● メンテナンス・サービスに取りかかる際には、まず電源スイッチを必ず切ってください。 	<ul style="list-style-type: none"> ● パネルやカバーを取り外したまま機械操作をしないで下さい。 	Japanese 注意事項
<ul style="list-style-type: none"> ● 頭部遠離煙霧。 ● 在呼吸區使用通風或排風器除煙。 	<ul style="list-style-type: none"> ● 維修前切斷電源。 	<ul style="list-style-type: none"> ● 儀表板打開或沒有安全罩時不準作業。 	Chinese 警告
<ul style="list-style-type: none"> ● 얼굴로부터 용접가스를 멀리하십시오. ● 호흡지역으로부터 용접가스를 제거하기 위해 가스제거기나 통풍기를 사용하십시오. 	<ul style="list-style-type: none"> ● 보수전에 전원을 차단하십시오. 	<ul style="list-style-type: none"> ● 판넬이 열린 상태로 작동치 마십시오. 	Korean 위험
<ul style="list-style-type: none"> ● ابعء رأسك بعيداً عن الدخان. ● استعمل التهوية أو جهاز ضغط الدخان للخارج لكي تبعد الدخان عن المنطقة التي تتنفس فيها. 	<ul style="list-style-type: none"> ● أقطع التيار الكهربائي قبل القيام بأية صيانة. 	<ul style="list-style-type: none"> ● لا تشغيل هذا الجهاز اذا كانت الاغطية الحديدية الواقية ليست عليه. 	Arabic تحذير

LEIA E COMPREENDA AS INSTRUÇÕES DO FABRICANTE PARA ESTE EQUIPAMENTO E AS PARTES DE USO, E SIGA AS PRÁTICAS DE SEGURANÇA DO EMPREGADOR.

使う機械や溶材のメーカーの指示書をよく読み、まず理解して下さい。そして貴社の安全規定に従って下さい。

請詳細閱讀並理解製造廠提供的說明以及應該使用的銀焊材料，並請遵守貴方的有閣勞動保護規定。

이 제품에 동봉된 작업지침서를 숙지하시고 귀사의 작업자 안전수칙을 준수하시기 바랍니다.

اقرأ بتمعن وافهم تعليمات المصنع المنتج لهذه المعدات والمواد قبل استعمالها واتبع تعليمات الوقاية لصاحب العمل.



• World's Leader in Welding and Cutting Products •

• Sales and Service through Subsidiaries and Distributors Worldwide •

Cleveland, Ohio 44117-1199 U.S.A. TEL: 216.481.8100 FAX: 216.486.1751 WEB SITE: www.lincolnelectric.com