

# DC-650 PRO

## Multiprocess DC Power Source

For use with machines having Code Numbers 9814, 9836 and 9839 Only.

### Safety Depends on You

Lincoln arc welding equipment is designed and built with safety in mind. However, your overall safety can be increased by proper installation ... and thoughtful operation on your part. **DO NOT INSTALL, OPERATE OR REPAIR THIS EQUIPMENT WITHOUT READING THIS MANUAL AND THE SAFETY PRECAUTIONS CONTAINED THROUGHOUT.** And, most importantly, think before you act and be careful.

Date of Purchase: \_\_\_\_\_

Serial Number: \_\_\_\_\_

Code Number: \_\_\_\_\_

Model: \_\_\_\_\_

Where Purchased: \_\_\_\_\_

**This manual covers equipment which is obsolete and no longer in production by The Lincoln Electric Co. Specifications and availability of optional features may have changed.**

## OPERATOR'S MANUAL



• World's Leader in Welding and Cutting Products •

• Sales and Service through Subsidiaries and Distributors Worldwide •

Cleveland, Ohio 44117-1199 U.S.A. TEL: 216.481.8100 FAX: 216.486.1751 WEB SITE: [www.lincolnelectric.com](http://www.lincolnelectric.com)



# WARNING

ARC WELDING can be hazardous.

**PROTECT YOURSELF AND OTHERS FROM POSSIBLE SERIOUS INJURY OR DEATH. KEEP CHILDREN AWAY. PACEMAKER WEARERS SHOULD CONSULT WITH THEIR DOCTOR BEFORE OPERATING.**

Read and understand the following safety highlights. For additional safety information it is strongly recommended that you purchase a copy of "Safety in Welding & Cutting - ANSI Standard Z49.1" from the American Welding Society, P.O. Box 351040, Miami, Florida 33135 or CSA Standard W117.2-1974. A **Free** copy of "Arc Welding Safety" booklet E205 is available from the Lincoln Electric Company, 22801 St. Clair Avenue, Cleveland, Ohio 44117-1199.

**BE SURE THAT ALL INSTALLATION, OPERATION, MAINTENANCE, AND REPAIR PROCEDURES ARE PERFORMED ONLY BY QUALIFIED INDIVIDUALS.**



## ELECTRIC SHOCK can kill.

- 1.a. The electrode and work (or ground) circuits are electrically "hot" when the welder is on. Do not touch these "hot" parts with your bare skin or wet clothing. Wear dry, hole-free gloves to insulate hands.
- 1.b. Insulate yourself from work and ground using dry insulation. Make certain the insulation is large enough to cover your full area of physical contact with work and ground.  
  
**In addition to the normal safety precautions, if welding must be performed under electrically hazardous conditions (in damp locations or while wearing wet clothing; on metal structures such as floors, gratings or scaffolds; when in cramped positions such as sitting, kneeling or lying, if there is a high risk of unavoidable or accidental contact with the workpiece or ground) use the following equipment:**
  - Semiautomatic DC Constant Voltage (Wire) Welder.
  - DC Manual (Stick) Welder.
  - AC Welder with Reduced Voltage Control.
- 1.c. In semiautomatic or automatic wire welding, the electrode, electrode reel, welding head, nozzle or semiautomatic welding gun are also electrically "hot".
- 1.d. Always be sure the work cable makes a good electrical connection with the metal being welded. The connection should be as close as possible to the area being welded.
- 1.e. Ground the work or metal to be welded to a good electrical (earth) ground.
- 1.f. Maintain the electrode holder, work clamp, welding cable and welding machine in good, safe operating condition. Replace damaged insulation.
- 1.g. Never dip the electrode in water for cooling.
- 1.h. Never simultaneously touch electrically "hot" parts of electrode holders connected to two welders because voltage between the two can be the total of the open circuit voltage of both welders.
- 1.i. When working above floor level, use a safety belt to protect yourself from a fall should you get a shock.
- 1.j. Also see Items 4.c. and 6.



## ARC RAYS can burn.

- 2.a. Use a shield with the proper filter and cover plates to protect your eyes from sparks and the rays of the arc when welding or observing open arc welding. Headshield and filter lens should conform to ANSI Z87.1 standards.
- 2.b. Use suitable clothing made from durable flame-resistant material to protect your skin and that of your helpers from the arc rays.
- 2.c. Protect other nearby personnel with suitable non-flammable screening and/or warn them not to watch the arc nor expose themselves to the arc rays or to hot spatter or metal.

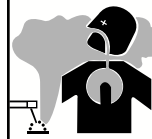

## FUMES AND GASES can be dangerous.

- 3.a. Welding may produce fumes and gases hazardous to health. Avoid breathing these fumes and gases. When welding, keep your head out of the fume. Use enough ventilation and/or exhaust at the arc to keep fumes and gases away from the breathing zone. **When welding with electrodes which require special ventilation such as stainless or hard facing (see instructions on container or MSDS) or on lead or cadmium plated steel and other metals or coatings which produce highly toxic fumes, keep exposure as low as possible and below Threshold Limit Values (TLV) using local exhaust or mechanical ventilation. In confined spaces or in some circumstances, outdoors, a respirator may be required. Additional precautions are also required when welding on galvanized steel.**
- 3.b. Do not weld in locations near chlorinated hydrocarbon vapors coming from degreasing, cleaning or spraying operations. The heat and rays of the arc can react with solvent vapors to form phosgene, a highly toxic gas, and other irritating products.
- 3.c. Shielding gases used for arc welding can displace air and cause injury or death. Always use enough ventilation, especially in confined areas, to insure breathing air is safe.
- 3.d. Read and understand the manufacturer's instructions for this equipment and the consumables to be used, including the material safety data sheet (MSDS) and follow your employer's safety practices. MSDS forms are available from your welding distributor or from the manufacturer.
- 3.e. Also see item 7b.

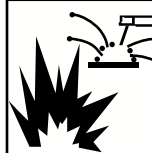

## WELDING SPARKS can cause fire or explosion.

- 4.a. Remove fire hazards from the welding area. If this is not possible, cover them to prevent the welding sparks from starting a fire. Remember that welding sparks and hot materials from welding can easily go through small cracks and openings to adjacent areas. Avoid welding near hydraulic lines. Have a fire extinguisher readily available.
- 4.b. Where compressed gases are to be used at the job site, special precautions should be used to prevent hazardous situations. Refer to "Safety in Welding and Cutting" (ANSI Standard Z49.1) and the operating information for the equipment being used.
- 4.c. When not welding, make certain no part of the electrode circuit is touching the work or ground. Accidental contact can cause overheating and create a fire hazard.
- 4.d. Do not heat, cut or weld tanks, drums or containers until the proper steps have been taken to insure that such procedures will not cause flammable or toxic vapors from substances inside. They can cause an explosion even though they have been "cleaned." For information purchase "Recommended Safe Practices for the Preparation for Welding and Cutting of Containers and Piping That Have Held Hazardous Substances", AWS F4.1 from the American Welding Society (see address above).
- 4.e. Vent hollow castings or containers before heating, cutting or welding. They may explode.

4.f. Sparks and spatter are thrown from the welding arc. Wear oil free protective garments such as leather gloves, heavy shirt, cuffless trousers, high shoes and a cap over your hair. Wear ear plugs when welding out of position or in confined places. Always wear safety glasses with side shields when in a welding area.

4.g. Connect the work cable to the work as close to the welding area as practical. Work cables connected to the building framework or other locations away from the welding area increase the possibility of the welding current passing through lifting chains, crane cables or other alternate circuits. This can create fire hazards or overheat lifting chains or cables until they fail.

4.h. Also see item 7c.

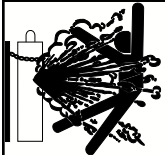

### **CYLINDER may explode if damaged.**

5.a. Use only compressed gas cylinders containing the correct shielding gas for the process used and properly operating regulators designed for the gas and pressure used. All hoses, fittings, etc. should be suitable for the application and maintained in good condition.

5.b. Always keep cylinders in an upright position securely chained to an undercarriage or fixed support.

5.c. Cylinders should be located:

- Away from areas where they may be struck or subjected to physical damage.
- A safe distance from arc welding or cutting operations and any other source of heat, sparks, or flame.

5.d. Never allow the electrode, electrode holder or any other electrically "hot" parts to touch a cylinder.

5.e. Keep your head and face away from the cylinder valve outlet when opening the cylinder valve.

5.f. Valve protection caps should always be in place and hand tight except when the cylinder is in use or connected for use.

5.g. Read and follow the instructions on compressed gas cylinders, associated equipment, and CGA publication P-1, "Precautions for Safe Handling of Compressed Gases in Cylinders," available from the Compressed Gas Association 1235 Jefferson Davis Highway, Arlington, VA 22202.



### **FOR ELECTRICALLY powered equipment.**

6.a. Turn off input power using the disconnect switch at the fuse box before working on the equipment.

6.b. Install equipment in accordance with the U.S. National Electrical Code, all local codes and the manufacturer's recommendations.

6.c. Ground the equipment in accordance with the U.S. National Electrical Code and the manufacturer's recommendations.



### **FOR ENGINE powered equipment.**

7.a. Turn the engine off before troubleshooting and maintenance work unless the maintenance work requires it to be running.



7.b. Operate engines in open, well-ventilated areas or vent the engine exhaust fumes outdoors.



7.c. Do not add the fuel near an open flame welding arc or when the engine is running. Stop the engine and allow it to cool before refueling to prevent spilled fuel from vaporizing on contact with hot engine parts and igniting. Do not spill fuel when filling tank. If fuel is spilled, wipe it up and do not start engine until fumes have been eliminated.



7.d. Keep all equipment safety guards, covers and devices in position and in good repair. Keep hands, hair, clothing and tools away from V-belts, gears, fans and all other moving parts when starting, operating or repairing equipment.

7.e. In some cases it may be necessary to remove safety guards to perform required maintenance. Remove guards only when necessary and replace them when the maintenance requiring their removal is complete. Always use the greatest care when working near moving parts.

7.f. Do not put your hands near the engine fan. Do not attempt to override the governor or idler by pushing on the throttle control rods while the engine is running.

7.g. To prevent accidentally starting gasoline engines while turning the engine or welding generator during maintenance work, disconnect the spark plug wires, distributor cap or magneto wire as appropriate.

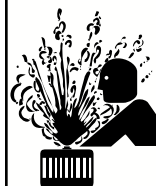

7.h. To avoid scalding, do not remove the radiator pressure cap when the engine is hot.



### **ELECTRIC AND MAGNETIC FIELDS may be dangerous**

8.a. Electric current flowing through any conductor causes localized Electric and Magnetic Fields (EMF). Welding current creates EMF fields around welding cables and welding machines.

8.b. EMF fields may interfere with some pacemakers, and welders having a pacemaker should consult their physician before welding.

8.c. Exposure to EMF fields in welding may have other health effects which are now not known.

8.d. All welders should use the following procedures in order to minimize exposure to EMF fields from the welding circuit:

8.d.1. Route the electrode and work cables together - Secure them with tape when possible.

8.d.2. Never coil the electrode lead around your body.

8.d.3. Do not place your body between the electrode and work cables. If the electrode cable is on your right side, the work cable should also be on your right side.

8.d.4. Connect the work cable to the workpiece as close as possible to the area being welded.

8.d.5. Do not work next to welding power source.

## PRÉCAUTIONS DE SÛRETÉ

Pour votre propre protection lire et observer toutes les instructions et les précautions de sûreté spécifiques qui paraissent dans ce manuel aussi bien que les précautions de sûreté générales suivantes:

### Sûreté Pour Soudage A L'Arc

1. Protégez-vous contre la secousse électrique:
  - a. Les circuits à l'électrode et à la pièce sont sous tension quand la machine à souder est en marche. Eviter toujours tout contact entre les parties sous tension et la peau nue ou les vêtements mouillés. Porter des gants secs et sans trous pour isoler les mains.
  - b. Faire très attention de bien s'isoler de la masse quand on soude dans des endroits humides, ou sur un plancher métallique ou des grilles métalliques, principalement dans les positions assis ou couché pour lesquelles une grande partie du corps peut être en contact avec la masse.
  - c. Maintenir le porte-électrode, la pince de masse, le câble de soudage et la machine à souder en bon et sûr état de fonctionnement.
  - d. Ne jamais plonger le porte-électrode dans l'eau pour le refroidir.
  - e. Ne jamais toucher simultanément les parties sous tension des porte-électrodes connectés à deux machines à souder parce que la tension entre les deux pinces peut être le total de la tension à vide des deux machines.
  - f. Si on utilise la machine à souder comme une source de courant pour soudage semi-automatique, ces précautions pour le porte-électrode s'appliquent aussi au pistolet de soudage.
2. Dans le cas de travail au dessus du niveau du sol, se protéger contre les chutes dans le cas où on recoit un choc. Ne jamais enrouler le câble-électrode autour de n'importe quelle partie du corps.
3. Un coup d'arc peut être plus sévère qu'un coup de soleil, donc:
  - a. Utiliser un bon masque avec un verre filtrant approprié ainsi qu'un verre blanc afin de se protéger les yeux du rayonnement de l'arc et des projections quand on soude ou quand on regarde l'arc.
  - b. Porter des vêtements convenables afin de protéger la peau de soudeur et des aides contre le rayonnement de l'arc.
  - c. Protéger l'autre personnel travaillant à proximité au soudage à l'aide d'écrans appropriés et non-inflammables.
4. Des gouttes de laitier en fusion sont émises de l'arc de soudage. Se protéger avec des vêtements de protection libres de l'huile, tels que les gants en cuir, chemise épaisse, pantalons sans revers, et chaussures montantes.
5. Toujours porter des lunettes de sécurité dans la zone de soudage. Utiliser des lunettes avec écrans latéraux dans les

zones où l'on pique le laitier.

6. Eloigner les matériaux inflammables ou les recouvrir afin de prévenir tout risque d'incendie dû aux étincelles.
7. Quand on ne soude pas, poser la pince à un endroit isolé de la masse. Un court-circuit accidentel peut provoquer un échauffement et un risque d'incendie.
8. S'assurer que la masse est connectée le plus près possible de la zone de travail qu'il est pratique de le faire. Si on place la masse sur la charpente de la construction ou d'autres endroits éloignés de la zone de travail, on augmente le risque de voir passer le courant de soudage par les chaînes de levage, câbles de grue, ou autres circuits. Cela peut provoquer des risques d'incendie ou d'échauffement des chaînes et des câbles jusqu'à ce qu'ils se rompent.
9. Assurer une ventilation suffisante dans la zone de soudage. Ceci est particulièrement important pour le soudage de tôles galvanisées plombées, ou cadmiées ou tout autre métal qui produit des fumées toxiques.
10. Ne pas souder en présence de vapeurs de chlore provenant d'opérations de dégraissage, nettoyage ou pistolage. La chaleur ou les rayons de l'arc peuvent réagir avec les vapeurs du solvant pour produire du phosgène (gas fortement toxique) ou autres produits irritants.
11. Pour obtenir de plus amples renseignements sur la sûreté, voir le code "Code for safety in welding and cutting" CSA Standard W 117.2-1974.

## PRÉCAUTIONS DE SÛRETÉ POUR LES MACHINES À SOUDER À TRANSFORMATEUR ET À REDRESSEUR

1. Relier à la terre le chassis du poste conformément au code de l'électricité et aux recommandations du fabricant. Le dispositif de montage ou la pièce à souder doit être branché à une bonne mise à la terre.
2. Autant que possible, l'installation et l'entretien du poste seront effectués par un électricien qualifié.
3. Avant de faire des travaux à l'intérieur de poste, la débrancher à l'interrupteur à la boîte de fusibles.
4. Garder tous les couvercles et dispositifs de sûreté à leur place.

# TABLE OF CONTENTS

	Page
GENERAL DESCRIPTION .....	7
SPECIFICATIONS .....	7
INSTALLATION .....	8-13
Location .....	8
Minimizing Problems Due to High Frequency .....	8
Input Connections .....	8
Output Connections .....	11
Wire Feeder Control Cable Connections .....	12
Connection of a K775 Remote Output Control .....	13
Connection to Auxiliary Power .....	13
EXPLANATION OF CONTROLS .....	13-14
OPERATING INSTRUCTIONS .....	15-18
GMAW (MIG) Operation .....	15
FCAW (Flux- Cored) Operation .....	16
SAW (Submerged Arc) Operation .....	16
SMAW (Stick) Operation .....	17
Operation with an LN-9 or NA-5 Wire Feeder .....	17
Setup and Operation .....	17
Connection of the Work Lead (21) .....	17
CAC-A (Arc Gouging) Operation .....	18
Installation with an NA-3 .....	18
PROTECTIVE CIRCUITRY .....	18
Thermostatic Protection .....	18
Overload Protection .....	19
MAINTENANCE .....	19
TROUBLESHOOTING .....	19-24
Power Source Troubleshooting .....	19
Troubleshooting Guide .....	20-24
PC Board Troubleshooting Procedure .....	25-26
WIRING DIAGRAM .....	27
DIMENSION PRINTS .....	28
PARTS PAGES .....	Appendix

# Thank You

for selecting a **QUALITY** product by Lincoln Electric. We want you to take pride in operating this Lincoln Electric Company product  
••• as much pride as we have in bringing this product to you!

### **Please Examine Carton and Equipment For Damage Immediately**

When this equipment is shipped, title passes to the purchaser upon receipt by the carrier. Consequently, Claims for material damaged in shipment must be made by the purchaser against the transportation company at the time the shipment is received.

Please record your equipment identification information below for future reference. This information can be found on your machine nameplate.

Model Name & Number \_\_\_\_\_

Code & Serial Number \_\_\_\_\_

Date of Purchase \_\_\_\_\_

Whenever you request replacement parts for or information on this equipment always supply the information you have recorded above.

**Read this Operators Manual completely** before attempting to use this equipment. Save this manual and keep it handy for quick reference. Pay particular attention to the safety instructions we have provided for your protection. The level of seriousness to be applied to each is explained below:

### **⚠ WARNING**

This statement appears where the information **must** be followed **exactly** to avoid **serious personal injury** or **loss of life**.

### **⚠ CAUTION**

This statement appears where the information **must** be followed to avoid **minor personal injury** or **damage to this equipment**.

## GENERAL DESCRIPTION

The DC-650 PRO is a multiprocess DC power source designed for the GMAW (MIG), FCAW, SMAW (Stick), and SAW (Sub-Arc) processes, with arc gouging capability as well. It features an international industrial rating of 700 amps, 44 volts at 100% duty cycle. It also has a dual rating of 600 amps, 44 volts at 100% duty cycle, in a 60°C ambient temperature environment.

The DC-650 PRO is available from the factory in one model only with a choice of input voltages. There are no factory installed options.

## TECHNICAL SPECIFICATIONS

Ordering Information	Product Description	Input Frequency	Rated Output	Additional Output	Dimensions & Weight
K1410	Multiprocess DC Power Source	60 Hz	700 Amps 44 Volts  100% Duty Cycle	600 Amps 44 Volts  100% Duty Cycle	27.50 <sup>(1)</sup> x 22.25 x 38 in (698 x 565 x 965 mm)  725 lbs (330 kg)

## INPUT SPECIFICATIONS

Input Voltage	Input Currents - 44 V Output			Idle Current	Idle Power <sup>(2)</sup>
	@ 600 A	@ 700 A	@ 750 A		
208 V	130 A	146 A	153 A	12 A	1.5 kW
230 V	117 A	132 A	139 A	11 A	1.5 kW
460 V	59 A	66 A	69 A	6 A	1.5 kW
575 V	47 A	53 A	56 A	5 A	1.5 kW

## OUTPUT SPECIFICATIONS

Rated Output (DC) At 40°C Ambient Temperature	Additional Output Ratings At 60°C Ambient Temperature	Auxiliary Outputs	Open Circuit Voltage	Output Current Range	Efficiency Power Factor <sup>(2)</sup>
700 Amps 44 Volts 100% Duty Cycle	600 Amps 44 Volts 100% Duty Cycle	<b>Two</b> 115 Volts AC 15 Amps	GMAW 15-45 FCAW 15-60 SAW 10-60	80-750 Amps	<b>@ 600A - 44V load:</b> Eff= 65% PF= .88
750 Amps 44 Volts 60% Duty Cycle	750 Amps 44 Volts 35% Duty Cycle	<b>One</b> 42 Volts AC 10 Amps	SMAW 65-70		<b>@ 700A - 44V load:</b> Eff= 66% PF= .90
					<b>@ 750A - 44V load:</b> Eff= 67% PF= .90

<sup>(1)</sup> Overall height 30.75 in (781 mm) including lift bale.

<sup>(2)</sup> Loaded readings are taken with a full auxiliary load. No load ratings are taken without auxiliary loads.

## INSTALLATION

### WARNING



**ELECTRIC SHOCK** can kill.

- Turn the input power off at the disconnect switch before installing or servicing this machine.
- Do not touch electrically “hot” parts such as output terminals or internal wiring.
- Connect grounding screw  to a good earth ground.
- Do not operate with covers removed.
- Turn power switch “OFF” before connecting or disconnecting cables or other equipment.
- Only qualified personnel should install or service this equipment.

Please read all of this section before starting installation. Refer to Figure 1 during installation.

### Location

Place the welder where clean cooling air can freely circulate in through the front louvers, and out through the rear louvers. The presence of dirt, dust or any foreign material that can be drawn in through the louvers should be kept to a minimum. Failure to observe these precautions can result in excessive operating temperatures, and welder shutdowns due to thermal overload.

DC-650 PRO power sources can be stacked three high, provided that the bottom machine is on a stable, hard, level surface. Be sure that the two pins in the roof of the lower machine fit into the holes in the base of the DC-650 PRO above it.

### Minimizing Problems Due to High Frequency

This welder, like all electrical equipment, can be subject to interference from strong sources of high frequency energy. Sources of high frequency energy include, but are not limited to, TIG welders, plasma cutters, and two-way radios. To minimize the potential for such interference, follow all of the installation instructions for equipment that will be installed in the same general area as the DC-650 PRO. Pay particular attention to instructions on grounding. The best preventative measure is to locate high frequency generating devices away from all other electrical equipment. Also, the input power lines going to those devices should be enclosed in solid metallic tubing or conduit.

## Input Connections

Be sure the voltage, phase and frequency of the input power is as specified on the rating plate. The rating plate is located on the front control panel of the DC-650 PRO.

An entry for the input power lines (#1, Fig. 1) is provided on the case back. The knockout is 2.00” (51 mm) in diameter. Access to the input panel connection area is gained by removing the two bolts which secure the Reconnect Door (#2, Fig. 1) and lifting the door upward.

Select the input lead wire sized according to local and national electrical codes. A chart conforming to the U.S. National Electrical Code is provided as a reference. (Table 1). Have a qualified electrician connect the input leads to terminals L1, L2 and L3 on the reconnect panel (#3, Fig. 1), in accordance with all local and national electrical codes, and with the diagram (#4, Fig. 1) located on the inside of the cover. Use a three phase line.

The frame of the welder must be grounded. A ground terminal (#5, Fig. 1) marked with the symbol  is located on the bottom of the input box for this purpose. Check local and national electrical codes for details on proper grounding methods.

On welders with multiple input voltages, be sure that the reconnect panel is connected per the instructions that follow.

### CAUTION

**FAILURE TO FOLLOW THESE INSTRUCTIONS CAN CAUSE IMMEDIATE FAILURE OF COMPONENTS INSIDE THE WELDER.**

Welders are shipped connected for the highest rated input voltage. To change this to a lower voltage, first reconnect the pilot transformer leads H2, H3 or H4 per the diagram attached to the inside of the reconnect door. Next, remove and reinstall the reconnect links according to the same diagram.

Fuse the input leads with the recommended size super lag fuses or delay type circuit breakers. See Table 1 for the recommended fuse and/or circuit breaker sizes. Using fuses or breakers smaller than those recommended may result in nuisance “tripping”, and possible damage to circuit breakers from welder inrush currents at turn on, even if the machine is not used to weld at high currents.



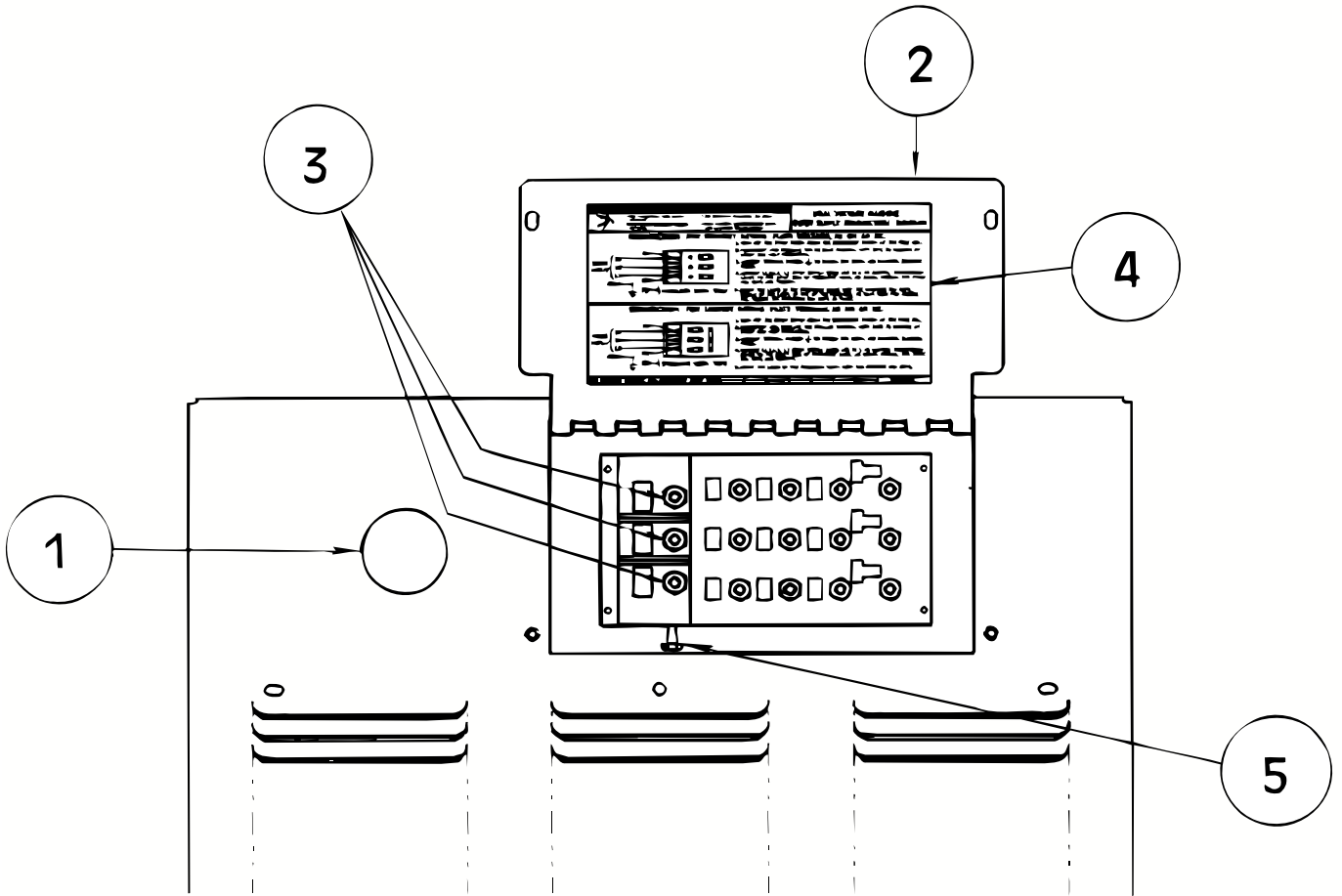

Figure 1

**Table 1**  
**RECOMMENDED INPUT WIRE AND FUSE SIZES <sup>(1)</sup>**

<b>Input Voltage / Frequency</b>	<b>Input Ampere Rating on Nameplate</b>	<b>Type 75°C Cu (Copper) Wire in Conduit</b>	<b>Grounding Wire Cu (Copper)</b>	<b>Fuse Size (Super Lag)</b>
208V / 60 Hz	130	1/0	6	200
230V / 60 Hz	117	1/0	6	175
460V / 60 Hz	59	4	8	100
575V / 60 Hz	47	6	8	75
200V / 50/60 Hz	138	2/0	4	225
220V / 50/60 Hz	125	1/0	6	200
380V / 50/60 Hz	73	4	6	125
400V / 50/60 Hz	69	4	8	100
415V / 50/60 Hz	66	4	8	100
440V / 50/60 Hz	63	4	8	100
500V / 50/60 Hz	55	6	8	75

<sup>(1)</sup> For a 600A / 44V / 100% duty cycle output in a 40°C ambient location. Refer to your local or national electrical code for other conditions.

## Output Connections

See Figure 2 for locations of the various case front connection points.

The DC-650 PRO output studs are mounted in pairs. The two studs in each pair are internally connected to each other with a buss bar. The studs have a 1/2-13 thread. Output cable lugs must have a hole large enough to clear a 1/2 inch stud. Choose the cable size from the table "Recommended Cable Sizes". Lengths shown are the total cable length, work cable length plus electrode cable length.

RECOMMENDED CABLE SIZES (RUBBER COVERED COPPER - RATED 75°C)				
		Cable Sizes for Combined Length of Work and Electrode Cables		
Output	Duty Cycle	0 - 100 ft (0 - 30 m)	100 - 200 ft (30 - 60 m)	200 - 250 ft (60 - 75 m)
700A	100%	2 - 2/0 (2 - 70 mm <sup>2</sup> )	2 - 3/0 (2 - 95 mm <sup>2</sup> )	2 - 4/0 (2 - 120 mm <sup>2</sup> )

Output cable strain reliefs are built into the DC-650 PRO base. Feed the output cables up through the strain relief holes before connecting to the output studs. This will prevent damage to the studs and the cables in the event the cables are pulled or stretched.

The positive connections can be made to the pair of studs on the lower right of the case front, marked "+" (#5, Figure 2). Connection can be made to either or both of the "+" studs.

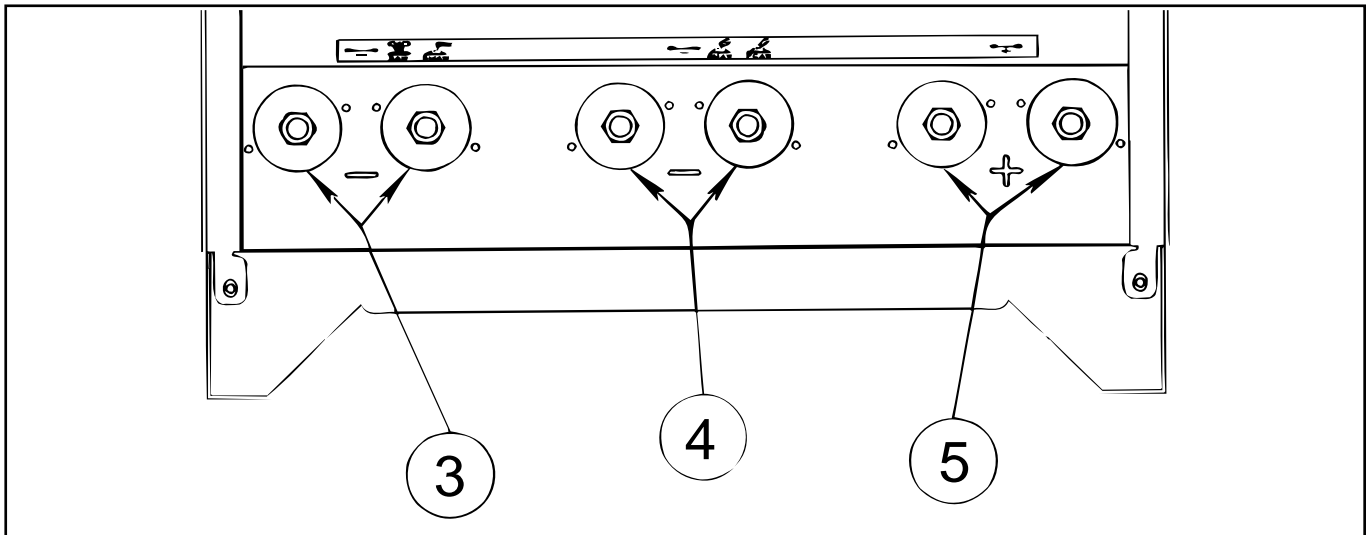

Figure 2

There are two pairs of studs for the negative connection. It is important to use the correct pair of studs, depending on the processes in use. NOTE: DO NOT CONNECT BOTH PAIRS OF NEGATIVE STUDS TOGETHER. USE EITHER ONE PAIR, OR THE OTHER, BUT NEVER CONNECT BOTH PAIRS TO THE WORKPIECE AT THE SAME TIME. Doing so will adversely affect the output characteristics of the machine, giving poor welding performance.

Note that the center pair is labeled "-" and "GMAW FCAW" (#4, Figure 2). This pair is to be used for constant voltage processes requiring low output inductance, such as gas metal arc welding, and flux-cored arc welding.

The left hand pair is labeled "-" and "SAW, SMAW" (#3, Figure 2). This pair is to be used for constant current processes, such as stick welding, as well as for submerged arc welding on constant voltage.

## Wire Feeder Control Cable Connections

Lincoln wire feeders can be hooked up to either the 14-pin Wire Feeder Receptacle (#12, Figure 3), or to the terminal strip (behind #11, Figure 3). The Wire Feeder Receptacle is the preferred method, because it virtually eliminates accidental miswirings.

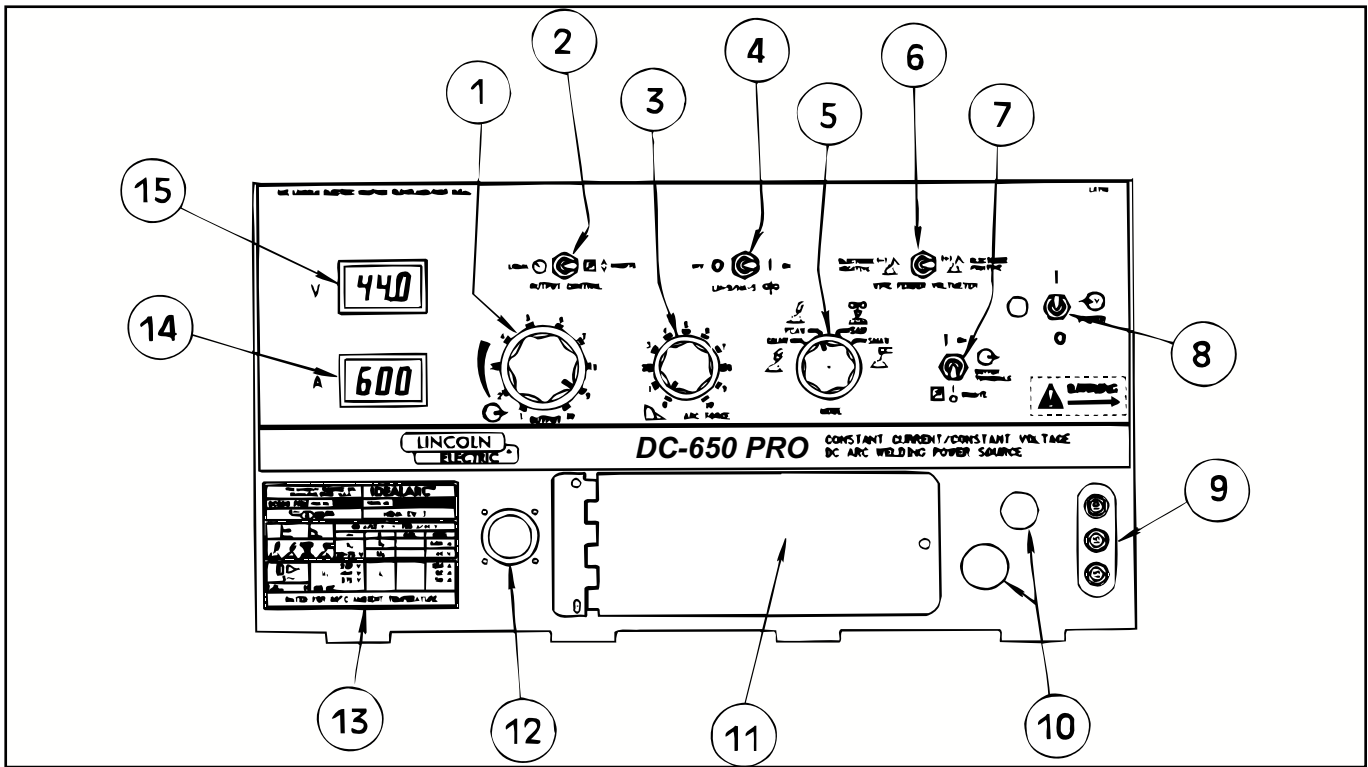

Figure 3

For connection to the Wire Feeder Receptacle, choose a control cable from the chart below:

Wire Feed Unit	Current Capacity	Duty Cycle	Cable Type *
LN-7	400A	60%	K480-XX
LN-8 / LN-9	600A	60%	K595-XX
NA-5	1000A	80%	K597-XX

\* Cables are available in various lengths. Consult your welding equipment distributor for availability.

For connection to the terminal strip, consult your Lincoln distributor for the appropriate wire feeder control cable. Feed the control cable end through the box connector on the case front, to provide a strain relief for the cable. Connect the numbered leads in the control cable to the terminals on the terminal strip, as depicted in Figure 4. For example, for cables with

leads A, B, and C, connect A to 75, B to 76 and C to 77, connect lead 2 to terminal 2, lead 4 to terminal 4, etc. Connect the green ground lead to the stud marked  $\overline{\text{TT}}$ .

## Connection of a K775 Remote Output Control

Feed the remote control cable through the box connector on the case front, to provide a strain relief for the cable. Connect the numbered leads in the control cable to the like numbered terminals on the right hand terminal strip (75 to 75, 76 to 76, and 77 to 77). Connect the green ground lead to the stud marked  $\text{r7}$ .

## Connection to Auxiliary Power

The DC-650 PRO has an extra 15 amps of 115 amp VAC auxiliary power, above what is required for wire feed equipment. This auxiliary supply is available on terminals 33 and 34 on the terminal strip. This supply is protected by a 15 amp circuit breaker.

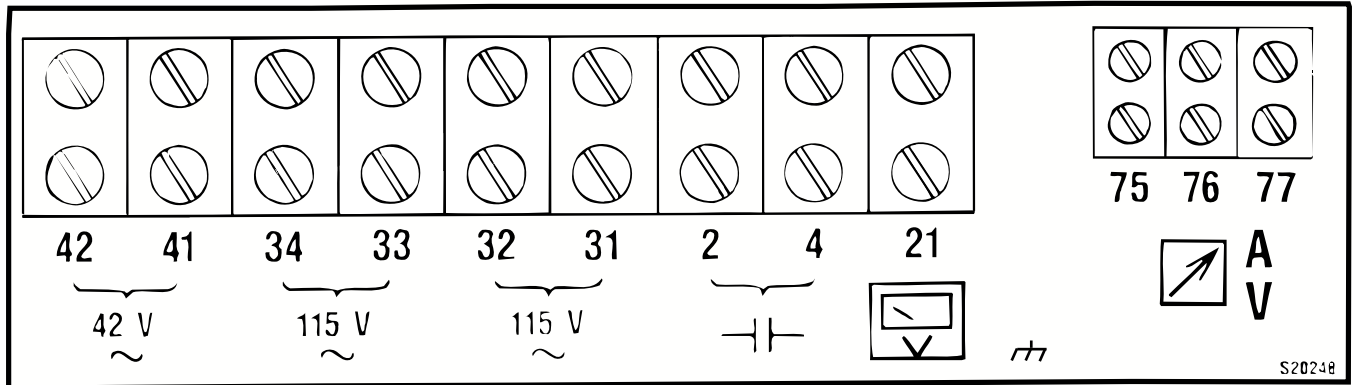

Figure 4

## EXPLANATION OF CONTROLS

Refer to Figure 3 for placement of the DC-650 PRO controls.

- Output Control Potentiometer**  
 Controls the output of the machine. Adjusts current when welding in the SMAW mode, and adjusts voltage when welding in the GMAW, FCAW and SAW modes. The Output Control switch must be in the Local position for this control to be active.
- Output Control Switch**  
 This switch chooses whether the DC-650 PRO output is adjusted from the front panel or by remote control. In the Local position, the Output Control Potentiometer adjusts the output. In the Remote position, the output is adjusted by either a wire feeder or an optional remote control. If using an LN-9 or NA-5 see "Operating with LN-9 or NA-5 Wire Feeder" section.
- Arc Force Potentiometer**  
 Active only in the SMAW (stick) mode. Adjusts the slope of the machine to give greater short circuit currents, necessary when using certain manual electrodes. When set to "0", there is no arc force action, giving a soft, buttery arc characteristic. When adjusted towards "10", the higher arc force action gives the arc a "digging" characteristic, which can help prevent the electrode from sticking to the work. The setting of this control has no effect in any other mode.
- LN-9 / NA-5 On/Off Switch**  
 This switch is set to "On" only when used with LN-9 and NA-5 wire feed units. For all other equipment, this switch is to be set to "Off". For proper operating with LN-9 and NA-5 wire feed units, the Output Control switch must be set to Remote, and the LN-9/NA-5 switch must be set to "On".

## 5. Mode Switch

This switch chooses the proper welding mode. Choose from GMAW (MIG), FCAW (flux-cored), SAW (submerged arc), or SMAW (stick). This switch electronically changes the welding characteristics depending on the mode setting.

**NOTE:** The welding cables must also be attached to the proper output studs for best welding performance (See “Output Connections” section).

## 6. Wire Feeder Voltmeter Switch

This switch changes the polarity of the wire feeder voltmeter sense lead, if the wire feeder is so equipped. Set to match the electrode polarity so that the wire feeder voltmeter can display the welding voltage. This switch has no effect on the welding output polarity of the DC-650 PRO.

## 7. Output Terminals Switch

This switch controls the solid-state output contactor circuitry in the DC-650 PRO. When set to the “On” position, the output studs are “hot” all of the time. When in the remote position, the contactor circuitry is controlled by the equipment connected to terminals 2 and 4, usually a wire feeder. Normally, this switch is turned “On” only when stick welding, arc gouging, or when using an arc powered wire feeder (such as an LN-25).

## 8. Power Switch and Pilot Light

Turns the DC-650 PRO on and off. The red pilot light illuminates when the machine is turned “On”.

## 9. Circuit Breakers

These circuit breakers provide overload protection for the auxiliary circuits. One 15 amp breaker is for the wire feeder 115V AC circuit (31 and 32), another 15 amp breaker is for the spare 115V AC auxiliary circuit (33 and 34). The 10 amp breaker is for the 42V AC wire feeder circuit (41 and 42).

## 10. Strain Reliefs

These strain reliefs are provided for control cables going to the terminal strips.

## 11. Terminal Strip Door

This access door provides protection for the terminal strip connections. (Lead numbers shown for this panel in Figure 3). The door can be opened by turning the fastener one-quarter turn counter-clockwise. Reverse this procedure to latch the door shut.

## 12. Wire Feeder Receptacle

This is the standard Lincoln, 14-pin, MS-type (amphenol) receptacle. See the DC-650 PRO wiring diagram for the pinout diagram of this receptacle.

## 13. Rating Plate

This plate contains important information regarding the code number, serial number, input voltages, input currents, and output ratings of the DC-650 PRO. Record the code and serial numbers in a safe place. These numbers will be required if replacement parts are needed in the future.

## 14. Digital Ammeter

Displays the output amperage when welding. If set to the SMAW (stick) mode, the ammeter displays the preset welding current when not welding. By using this meter, the output current can be set to a predetermined value before an arc is struck. This permits repeatability when changing and setting procedures. The output current can be preset from the Output Control or from a remote control attached to the terminal strip.

## 15. Digital Voltmeter

Displays the output voltage as measured on the output studs of the machine.

**NOTE:** Due to voltage drops in the welding cables and at cable connection points, the actual arc voltage may be lower than that displayed on the voltmeter. Use welding cables of the proper capacity and make sure all connections are tight to minimize this effect.

If set to either the GMAW, FCAW, or SAW modes, this meter can display the preset welding voltage when the secondary output contactor is open (usually when the gun trigger is released). By using this meter, the output voltage can be set to a predetermined value before an arc is struck. This permits repeatability when changing and setting procedures. The output voltage can be preset from the Output Control or from a remote control attached to the terminal strip. The only exception occurs when the DC-650 PRO is used with an LN-9 or NA-5; with those wire feeders, the preset voltage can only be read on the wire feed unit. The DC-650 PRO voltmeter will display “---” when in the LN-9/NA-5 mode. (see “Operation with LN-9 or NA-5 Wire Feeder” section).

# OPERATING INSTRUCTIONS

## ⚠ WARNING



**ELECTRIC SHOCK** can kill.

- Do not touch electrically live parts or electrode with skin or wet clothing.
- Insulate yourself from work and ground.
- Always wear dry insulating gloves.



**FUMES AND GASES** can be dangerous.

- Keep your head out of fumes.
- Use ventilation or exhaust to remove fumes from breathing zone.

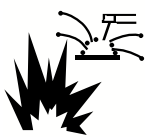

**WELDING SPARKS** can cause fire or explosion.

- Keep flammable material away.
- Do not weld on closed containers.



**ARC RAYS** can burn eyes and skin.

- Wear eye, ear and body protection.

See additional warning information at front of this operator's manual.

## GMAW (MIG) Operation

Properly connect a wire feeder control cable to either the terminal strip or to the Wire Feeder Receptacle.

If welding electrode positive, connect the electrode cable to the “+” output studs. Connect the work cable to the center output studs, labeled “GMAW, FCAW”. Do not make any connections to the left hand pair of output studs.

Set the control panel switches as follows:

Mode: GMAW

Output Control: Local or Remote (See “Output Control Switch”)

LN-9/NA-5: Off, unless an LN-9 or NA-5 is being used.

Wire Feeder Voltmeter: Set to match the electrode polarity.

Output Terminals: Remote

If using Local output control, preset the desired welding voltage using the Output potentiometer and the voltmeter. If using Remote Output control, preset the welding voltage using a remote control, or with the voltage control on the wire feeder. If using an LN-9, see “Operation with LN-9 or NA-5 Wire feeder” section.

Set up the wire feeder according to the wire feeder instruction manual.

When the gun trigger is pulled (or the weld sequence is started) and an arc is struck, the voltmeter will display the welding voltage preset at the output studs of the DC-650 PRO, and the ammeter will display the output current.

## FCAW (Flux-Cored) Operation

Properly connect a wire feeder control cable to either the terminal strip or to the Wire Feeder Receptacle.

If welding electrode positive, connect the electrode to the “+” output studs, and connect the work cable to the “-” studs labeled “GMAW, FCAW”. If welding electrode negative, reverse the connections. Do not make any connections to the left hand pair of output studs.

Set the control panel switches as follows:

-----  
**Mode:** FCAW

-----  
**Output Control:** Local or Remote (See “Output Control Switch”)

-----  
**LN-9/NA-5:** Off, unless an LN-9 or NA-5 is being used.

-----  
**Wire Feeder Voltmeter:** Set to match the electrode polarity.

-----  
**Output Terminals:** Remote

-----  
If using Local output control, preset the desired welding voltage using the Output potentiometer and the voltmeter. If using Remote Output control, preset the welding voltage using a remote control, or with the voltage control on the wire feeder. If using an LN-9 and NA-5, see “operation with LN-9 or NA-5 Wire Feeder” section.

Set up the wire feeder according to the wire feeder instruction manual.

When the gun trigger is pulled (or the weld sequence is started) and an arc is struck, the voltmeter will display the welding voltage present at the output studs of the DC-650 PRO, and the ammeter will display the output current.

## SAW (Submerged Arc) Operation

Properly connect a wire feeder control cable to either the terminal strip or to the Wire Feeder Receptacle.

If welding electrode positive, connect the electrode cable to the “+” output studs, and connect the work cable to the “-” studs labeled “SMAW, SAW”. If welding electrode negative, reverse the connections. Do not make any connections to the center pair of output studs.

Set the control panel switches as follows:

-----  
**Mode:** SAW

-----  
**Output Control:** Local or Remote (See “Output Control Switch”)

-----  
**LN-9/NA-5:** Off, unless an LN-9 or NA-5 is being used.

-----  
**Wire Feeder Voltmeter:** Set to match the electrode polarity.

-----  
**Output Terminals:** Remote

-----  
If using Local output control, preset the desired welding voltage using the Output Potentiometer and the voltmeter. If using Remote output control, preset the welding voltage using a remote control, or with the voltage control on the wire feed unit. If using an LN-9 or NA-5, see “Operation with LN-9 or NA-5 Wire Feeder “ section.

Set up the wire feed unit according to the wire feeder instruction manual.

When the gun trigger is pulled (or the weld sequence is started) and an arc is struck, the voltmeter will display the welding voltage present at the output studs of the DC-650 PRO, and the ammeter will display the output current.



## SMAW (Stick) Operation

If welding electrode positive connect the electrode cable to the “+” output studs, and connect the work cable to the “-” studs labeled “SMAW,SAW”. If welding electrode negative, reverse the connections. Do not make any connections to the center pair of output studs.

Set the control panel switches as follows:

-----  
**Mode:** SMAW  
-----

**Output Control:** Local or Remote (See “Output Control Switch”)  
-----

**LN-9/NA-5:** Off  
-----

**Wire Feeder Voltmeter:** Has no effect in the SMAW mode.  
-----

**Output Terminals:** On  
-----

If using Local output control, preset the desired welding voltage using the Output Potentiometer and the voltmeter. If using Remote output control, preset the welding voltage using a remote control.

Set the Arc Force potentiometer according to the arc characteristics desired. With certain electrodes, such as low hydrogen alloy electrodes, it is beneficial to set the Arc Force to a high setting. This gives a more forceful arc, less prone to sticking and stubbing. Setting this control too high can lead to excessive spatter. It is often best to start stick welding with the Arc Force set to minimum, and if sticking is a problem, raise the setting until the electrode runs smoothly.

The output terminals will always be “hot”. Before an arc is struck, the ammeter will display the preset current. When an arc is struck, the ammeter will display the actual output current. In the SMAW mode, the voltmeter always displays the output voltage present at the output studs of the DC-650 PRO.

## Operation with an LN-9 or NA-5 Wire Feeder

**NOTE:** Conversion Kits are required for LN-9’s and NA-5’s used with the DC-650 PRO.

For LN-9 and LN-9GMA model codes above 9100 order K442-1.

For LN-9 models below code 9100 order K442-2.

For NA-5 models below code 9100, order K442-3.

For NA-5 models above code 9100, order K442-4.

### Setup and Operation

These wire feeders are called presettable wire feeders. The welding voltage is set on the wire feeder, and then maintained throughout the weld by circuitry in the wire feeder. It makes continuous adjustments during the weld to maintain the proper arc voltage. Because the wire feeder takes control of the arc voltage, the DC-650 PRO must be told that an LN-9 or NA-5 is in control. This is done by setting the LN-9/NA-5 On/Off switch to the “On” position.

To use an LN-9 or NA-5, the Output Control switch must be set to “Remote”. Output voltage control is now done through the terminal strip, or through the wire feeder receptacle, rather than with the front panel Output potentiometer. Additionally, the LN-9/NA-5 switch must be set to “On”. This tells the DC-650 PRO that an LN-9 or NA-5 is in control. The DC-650 PRO Voltmeter will no longer display the preset welding voltage. The preset welding voltage must be read at the LN-9 or NA-5. The DC-650 PRO Voltmeter will display “---” when not welding.

When welding, the Voltmeter displays the welding voltage, as measured on the output studs of the DC-650 PRO. This voltage may be higher than that displayed on the LN-9 or NA-5, due to voltage drops in the cables and cable connection points. The ammeter displays the actual welding current.

### Connection of the Work Lead (21)

In some applications, very precise arc voltage sensing is required. This requires that the wire feeder arc voltage sensing lead, number 21, be extended directly to the workpiece. Instructions follow for extending that lead.

When using the Wire Feeder Receptacle, extend the 21 lead to the workpiece as follows:

1. Turn the input power off.
2. Open the terminal strip door. When installing the wire feeder, do not connect the lead marked 21 coming from the wire feeder control cable to the

terminal strip. (See Figure 4). Instead, extend the wire feeder control cable 21 lead to the workpiece. Insulate the 21 lead connection with tape or other means to achieve 300V withstand capability.

The LN-9 or NA-5 will now sense arc voltage through this work sense lead. The DC-650 PRO meters will continue to read the output stud voltage, so there may be a difference between the DC-650 PRO voltmeter and the wire feeder voltmeter.

When using the terminal strip for wire feeder connection, extend the 21 lead to the workpiece as follows:

1. Turn the input power Off.
2. Open the terminal strip door. When installing the wire feeder, do not connect the lead marked 21 coming from the wire feeder control cable to the terminal strip. (See Figure 4). Instead, extend the wire feeder control cable 21 lead to the workpiece. Insulate the 21 lead connection with tape or other means to achieve 300V withstand capability.

The LN-9 or NA-5 will now sense arc voltage through this work sense lead. The DC-650 PRO meters will continue to read the output stud voltage, so there may be a difference between the DC-650 PRO voltmeter and the wire feeder voltmeter.

## K317 DUAL PROCESS KIT (FOR WIRE FEEDERS USING SAME POLARITY)

This kit permits the connection of two wire feeders to the DC650 PRO. Both feeders will weld with the same electrode polarity. When the trigger of the desired wire feeder is pressed, the DC650 PRO output control leads (75, 76, and 77) will be connected to that feeder and the procedure as set on its controls will be provided. The other connected wire feeder will not be feeding wire but is electrically hot. The kit mounts at the power source and is connected to the power source terminal strip with the supplied leads.

Installation instructions are included with the kit.

NOTE: When using the DC650 PRO power source the K317 Dual Process Kit can only be used with two like wire feeders. An LN-9 cannot be used with an LN-8. Only two LN-9's may be used together or two LN-8's together.

### AC-A (Arc Gouging) Operation

Most arc gouging is done with constant voltage output. Connect the electrode lead to the "+" output studs, and the work lead to the "-" studs labeled "GMAW, FCAW". Do not make any connections to the left hand pair of output studs.

Set the control panel switches as follows:

-----  
**Mode:** GMAW  
-----

**Output Control:** Local or Remote (See "Output Control Switch")  
-----

**LN-9/NA-5:** Off  
-----

**Wire Feeder Voltmeter:** Has no effect when arc gouging.  
-----

**Output Terminals:** On  
-----

If using Local output control, preset the desired voltage (approximately 40 volts) using the Output potentiometer and the volt meter. If using Remote output control, preset the voltage using a remote control. Begin gouging, and then adjust the output up or down as necessary.

## Installation with an NA-3

As supplied from the factory, the cold inch feature in the NA-3 will not work when used with a DC-650 PRO in negative polarity operation. Contact the factory for information regarding an NA-3 modification procedure that will allow the cold inch feature to work with the DC-650 PRO under these conditions.

## PROTECTIVE CIRCUITRY

### Thermostatic Protection

The DC-650 PRO has a thermostat in both the primary and secondary circuits.

The primary thermostat, located inside the right primary coil, will open up if the main transformer overheats. The machine will completely shut off when the primary thermostat opens. The machine must be allowed to cool before it can be restarted.

The secondary thermostat, located on the secondary common lead at the front of the main transformer, will open if the output is overloaded, the duty cycle is exceeded, or if the flow of cooling air is blocked. When the secondary thermostat opens, power will be removed from control transformer T3, causing the Control PC Board to lose power. The meter displays will go off, and there will be no output from the DC-650 PRO. The pilot light will remain lit, and the fan will continue to run. When the machine cools down, the thermostat will close automatically, and normal operation will be restored.

## Overload Protection

The DC-650 PRO is protected from excessive output currents by phaseback circuitry on the Control PC board. If the output current exceeds approximately 850 amps, the output of the machine will phase back to a low value. It will remain at a low value until the load is removed.

If the output is shorted in one of the constant voltage modes (GMAW, FCAW, or SAW) the output may phase back all the way to zero. The short must be removed from the output, and the protective circuits reset before welding can continue. To reset them, shut the DC-650 PRO off, and then turn it back on again.

## Routine Maintenance

1. The fan motor has sealed bearings which require no service.
2. In extremely dusty locations, dirt may clog the air channels causing the welder to run hot. Blow out the machine at regular intervals.
3. In extremely dusty locations, dirt may accumulate on the remote control terminal strip. Wipe or blow this terminal strip off at regular intervals. This is particularly important in damp locations

## TROUBLESHOOTING

### **WARNING**



**ELECTRIC SHOCK** can kill.

- Have a qualified individual install and service this equipment.
- Turn the input power off at the fuse box before working on equipment.
- Do not touch electrically hot parts.

## Power Source Troubleshooting

Most welding equipment problems, particularly in new installations, can be traced to incorrect installation or incorrect procedures. Be sure that the DC-650 PRO is properly connected, all accessories and wire feeders are working correctly, and that valid welding procedures are being used.

## TROUBLESHOOTING

TROUBLE	CAUSE	WHAT TO DO
A. Input contactor chatters.	<ol style="list-style-type: none"> <li>1. Faulty input contactor.</li> <li>2. Low line voltage.</li> <li>3. Pilot transformer (T2) misconnected.</li> </ol>	<ol style="list-style-type: none"> <li>1. Refer to wiring diagram &amp; check related leads.</li> <li>2. Check input power.</li> <li>3. Check input connection instructions.</li> </ol>
B. Machine input contactor does not operate.	<ol style="list-style-type: none"> <li>1. Supply line fuse blown.</li> <li>2. Contactor power circuit dead.</li> <li>3. Broken power lead.</li> <li>4. Wrong input voltage.</li> <li>5. Primary thermostats open.</li> <li>6. Open input contactor coil.</li> <li>7. Power "On/Off" switch (S1) not closing.</li> </ol>	<ol style="list-style-type: none"> <li>1. Replace if blown-look for reason first.</li> <li>2. Check pilot transformer T2 and associated leads.</li> <li>3. Check input voltage at contactor.</li> <li>4. Check voltage against instructions.</li> <li>5. Check for overheating; make sure fan is operating and there is no obstruction to free air flow. Replaces faulty thermostat.</li> <li>6. Replace coil.</li> <li>7. Replace switch.</li> </ol>
C. Machine input contactor operates, but no output when trying to weld.	<ol style="list-style-type: none"> <li>1. Electrode or work lead loose or broken.</li> <li>2. Open main transformer (T1) primary or secondary circuit.</li> <li>3. Defective Control P.C. Boards.</li> <li>4. Output terminals switch set wrong or faulty.</li> <li>5. Secondary thermostat open.</li> </ol>	<ol style="list-style-type: none"> <li>1. Repair connection.</li> <li>2. Repair.</li> <li>3. Replace. See P.C. Board Troubleshooting Procedure.</li> <li>4. Check setting/operation of the Output Terminals switch.</li> <li>5. Check for overheating; make sure fan is operating and there is no obstruction to free air flow. Replaces faulty thermostat.</li> </ol>
D. Machine has high output and no control.	<ol style="list-style-type: none"> <li>1. Fault in leads 75, 76, or 77.</li> <li>2. Open in feedback circuitry.</li> </ol>	<ol style="list-style-type: none"> <li>1. Check wiring.</li> <li>2. Check control and protection PC Board wiring. With input power off, check for continuity between (+) output stud and lead and 1J12 on the control board. Also check for continuity between GMAW/FCAW (-) output stud and 3J12 on the control board. Finally, check for continuity between SMAW/SAW (-) output stud and 2J12. Repair if necessary.</li> </ol>

### CAUTION

If for any reason you do not understand the test procedures or are unable to perform the tests/repairs safely, contact your **Local Lincoln Authorized Field Service Facility** for technical troubleshooting assistance before you proceed.

## TROUBLESHOOTING

TROUBLE	CAUSE	WHAT TO DO
E. Machine has low output and no control.	<ol style="list-style-type: none"> <li>1. Output control Local/Remote switch in wrong position.</li> <li>2. Output control switch faulty.</li> <li>3. Fault in leads 75,76, or 77.</li> <li>4. Faulty Control P.C. Board.</li> <li>5. Output control potentiometer circuit open (lead 75).</li> </ol>	<ol style="list-style-type: none"> <li>1. Check position of switch.</li> <li>2. Check switch and replace if faulty.</li> <li>3. Check wiring.</li> <li>4. Replace. See P.C. Board Troubleshooting Procedure.</li> <li>5. Check and replace potentiometer if faulty. Check wiring of lead #75.</li> </ol>
F. Machine does not have maximum output.	<ol style="list-style-type: none"> <li>1. One input fuse blown.</li> <li>2. One phase of main transformer open.</li> <li>3. Faulty Control P.C. Board.</li> <li>4. Output control potentiometer.</li> <li>5. Output control potentiometer lead 75 open.</li> <li>6. Defective main SCR bridge.</li> </ol>	<ol style="list-style-type: none"> <li>1. Check and replace if blown after checking for reason for blown fuse.</li> <li>2. Check for open and repair.</li> <li>3. Replace. See P.C. Board Troubleshooting Procedure.</li> <li>4. Check and replace if faulty.</li> <li>5. Check and repair broken leads.</li> <li>6. Check and replace if defective.</li> </ol>
G. Machine will not shut off.	<ol style="list-style-type: none"> <li>1. Input contactor contacts frozen.</li> <li>2. Defective On/Off switch, S-1.</li> </ol>	<ol style="list-style-type: none"> <li>1. Check and replace if necessary.</li> <li>2. Replace.</li> </ol>
H. Variable or sluggish welding arc.	<ol style="list-style-type: none"> <li>1. Poor work or electrode connection.</li> <li>2. Welding leads too small.</li> <li>3. Welding current or voltage too low.</li> <li>4. Leads or connections open in control circuit.</li> <li>5. LN-9/NA-5 switch in wrong position.</li> </ol>	<ol style="list-style-type: none"> <li>1. Check &amp; clean all connections.</li> <li>2. Check table in instruction manual.</li> <li>3. Check procedures for recommended settings.</li> <li>4. Check &amp; replace if defective.</li> <li>5. Only connect one pair of negative studs to the work.</li> </ol>

### CAUTION

If for any reason you do not understand the test procedures or are unable to perform the tests/repairs safely, contact your **Local Lincoln Authorized Field Service Facility** for technical troubleshooting assistance before you proceed.

## TROUBLESHOOTING

TROUBLE	CAUSE	WHAT TO DO
<p>I. Output control not functioning on the machine.</p>	<ol style="list-style-type: none"> <li>1. Output control switch in wrong position.</li> <li>2. Faulty output control switch.</li> <li>3. Faulty output control potentiometer.</li> <li>4. Leads or connections open in control circuit.</li> <li>5. LN-9/NA-5 switch in wrong position.</li> <li>6. Faulty Control P.C. Board.</li> </ol>	<ol style="list-style-type: none"> <li>1. Place switch in "Local" position.</li> <li>2. Check &amp; replace if found faulty.</li> <li>3. Check &amp; replace if found faulty.</li> <li>4. Check lead continuity and connections for an open and repair if necessary.</li> <li>5. Set to "Off" when not using an LN-9/NA-5.</li> <li>6. Replace. See P.C. Board Troubleshooting Procedure.</li> </ol>
<p>J. Output control not functioning on remote control.</p>	<ol style="list-style-type: none"> <li>1. Output control switch in wrong position.</li> <li>2. Faulty output control switch.</li> <li>3. Faulty remote control potentiometer.</li> <li>4. Leads or connections open in control circuit.</li> <li>5. Faulty Control P.C. Board.</li> </ol>	<ol style="list-style-type: none"> <li>1. Place switch in "Output Control Remote".</li> <li>2. Check &amp; replace if found faulty.</li> <li>3. Check &amp; replace if found faulty.</li> <li>4. Check all leads and connections, internal or remote, for continuity; repair if necessary.</li> <li>5. Replace. See P.C. Board Troubleshooting Procedure.</li> </ol>
<p>K. Digital meters do not light - or - Digital meter display is incorrect.</p>	<ol style="list-style-type: none"> <li>1. Faulty Meter P.C. Board.</li> <li>2. Faulty Control P.C. Board.</li> <li>3. Secondary thermostat is open.</li> </ol>	<ol style="list-style-type: none"> <li>1. Replace. See P.C. Board Troubleshooting Procedure.</li> <li>2. Replace. See P.C. Board Troubleshooting Procedure.</li> <li>3. See "Thermostatic Protection" section.</li> </ol>
<p>L. Poor arc striking with semiautomatic wire feeders.</p>	<ol style="list-style-type: none"> <li>1. Poor work connection.</li> <li>2. Improper procedures.</li> <li>3. Defective P.C. Board.</li> </ol>	<ol style="list-style-type: none"> <li>1. Work connection must be adequate for application.</li> <li>2. Adjust procedures for improved starting.</li> <li>3. Replace. See P.C. Board Troubleshooting Procedure.</li> </ol>

## TROUBLESHOOTING

TROUBLE	CAUSE	WHAT TO DO
M. Poor arc characteristics in GMAW mode.	<ol style="list-style-type: none"> <li>1. Capacitor bank not switching in.</li> <li>2. Capacitor(s) in output circuit failed. A failure is indicated if the small vent plug on top of a capacitor is raised or blown out.</li> </ol>	<ol style="list-style-type: none"> <li>1. Check the Mode SCR (SCR7). Should be on when in GMAW and FCAW modes.</li> <li>2. Replace entire bank of capacitors. Do <u>not</u> replace individual capacitors.</li> </ol> <p><b>WARNING:</b> The liquid electrolyte in these capacitors is toxic. Avoid contact with any portion of your body. Clean up vented electrolyte using rubber gloves and a water dampened cloth. Remove any electrolyte which gets on skin using soap and water.</p>
N. Ammeter displays “Err” and Voltmeter displays a number	<ol style="list-style-type: none"> <li>1. An error has been detected.</li> </ol>	<ol style="list-style-type: none"> <li>1. See Error code Troubleshooting Guide.</li> </ol>

## ACCESSORY TROUBLESHOOTING

TROUBLE	CAUSE	WHAT TO DO
A. Output Control not functioning on Remote Control.	<ol style="list-style-type: none"> <li>1. Output Control switch in wrong position.</li> <li>2. Faulty Output Control switch.</li> <li>3. Faulty Remote Control potentiometer.</li> <li>4. Leads or connections open in control circuit.</li> <li>5. Faulty Control P.C. Board.</li> </ol>	<ol style="list-style-type: none"> <li>1. Place switch in “Remote”.</li> <li>2. Check &amp; replace if found faulty.</li> <li>3. Check &amp; replace if found faulty.</li> <li>4. Check all leads &amp; connections.</li> <li>5. See P.C. Board Troubleshooting Procedure.</li> </ol>
B. Output Control not functioning on the machine.	<ol style="list-style-type: none"> <li>1. Output Control switch in the wrong position.</li> <li>2. Faulty Output Control switch.</li> <li>3. Faulty Output Control potentiometer.</li> </ol>	<ol style="list-style-type: none"> <li>1. Place switch in “Local” position.</li> <li>2. Check &amp; replace if found faulty.</li> <li>3. Check &amp; replace if found faulty.</li> </ol>

### CAUTION

If for any reason you do not understand the test procedures or are unable to perform the tests/repairs safely, contact your **Local Lincoln Authorized Field Service Facility** for technical troubleshooting assistance before you proceed.

# TROUBLESHOOTING

Observe all Safety Guidelines detailed throughout this manual

## ERROR CODES DISPLAYED ON VOLTMETER WHEN AMMETER DISPLAYS “ERR”

The DC-650 PRO Meter PC Board displays error codes when certain trouble conditions exist. The error codes, trouble conditions, and possible remedies are listed below.

ERROR CODE	TROUBLE	REMEDY
Err 000	<ol style="list-style-type: none"> <li>1. Output overload.</li> <li>2. Shunt miswired or unconnected.</li> <li>3. Faulty Control PC Board.</li> </ol>	<ol style="list-style-type: none"> <li>1. Reduce output overload.</li> <li>2. Check shunt and wiring. Repair if necessary.</li> <li>3. Replace, See PC Board Troubleshooting Procedure.</li> </ol>
Err 013	<ol style="list-style-type: none"> <li>1. Missing Phase Signal.</li> <li>2. Faulty Control PC Board.</li> </ol>	<ol style="list-style-type: none"> <li>1. Check for 66 VAC <math>\pm</math>10% between leads 329 and 332 of J12 at control board. Repair if necessary.</li> <li>2. Replace. See PC Board Troubleshooting Procedure.</li> </ol>
Err 014-016	<ol style="list-style-type: none"> <li>1. Faulty Control PC Board.</li> </ol>	<ol style="list-style-type: none"> <li>1. Replace. See PC Board Troubleshooting Procedure.</li> </ol>
Err 023	<ol style="list-style-type: none"> <li>1. Noisy line.</li> <li>2. Faulty Control PC Board.</li> </ol>	<ol style="list-style-type: none"> <li>1. Make sure machine frame is grounded. See installation section on minimizing problems due to high frequency interference.</li> <li>2. Replace. See PC Board Troubleshooting Procedure.</li> </ol>
Err 030	<ol style="list-style-type: none"> <li>1. Control transformer miswired.</li> <li>2. Main Transformer Auxiliary miswired.</li> <li>3. Faulty Control PC Board.</li> </ol>	<ol style="list-style-type: none"> <li>1. Swap leads 330 and 332A at Control Transformer T3 in the control box.</li> <li>2. Check leads 29, 30B, and 32B from main transformer. Repair if necessary.</li> <li>3. Replace. See PC Board Troubleshooting Procedure.</li> </ol>
Err 100-131	<ol style="list-style-type: none"> <li>1. Mode Switch is set between two positions.</li> <li>2. Faulty Mode Switch.</li> <li>3. Mode Switch wiring bad.</li> <li>4. Faulty Control Board.</li> </ol>	<ol style="list-style-type: none"> <li>1. Reposition mode switch.</li> <li>2. Check and replace if found faulty.</li> <li>3. Check all leads for continuity. Repair if necessary.</li> <li>4. Replace. See PC Board Troubleshooting Procedure.</li> </ol>
Err 200-206	<ol style="list-style-type: none"> <li>1. Noisy input line.</li> <li>2. Faulty Control PC Board.</li> </ol>	<ol style="list-style-type: none"> <li>1. Make sure machine frame is grounded. See installation section on minimizing problems due to high frequency interference.</li> <li>2. Replace. See PC Board Troubleshooting Procedure.</li> </ol>

**CAUTION**

If for any reason you do not understand the test procedures or are unable to perform the tests/repairs safely, contact your **Local Lincoln Authorized Field Service Facility** for technical troubleshooting assistance before you proceed.



## Procedure for Troubleshooting PC Boards

### WARNING



**ELECTRIC SHOCK** can kill.

- Have a qualified individual install and service this equipment.
  - Turn the power source input power off at the disconnect switch before working on this equipment.
- Do not touch electrically hot parts.
- 

Before replacing a PC board which is suspected of being defective, visually inspect the PC board in question for any electrical or mechanical damage to any of its components and conductors on the back of the board.

- a. If there is no visible damage to the PC board, install a new one and see if this remedies the problem. If the problem is remedied, reinstall the old PC board to see if the problem still exists. If it does no longer exist with old PC board:
  1. Check the PC board harness connector pins for corrosion, contamination, or looseness.
  2. Check leads in the plug harness for loose or intermittent connection.
- b. If PC board is visibly damaged electrically, before possibly subjecting the new PC board to the same cause of failure, check for possible shorts, opens, or grounds caused by:
  1. Frayed or pinched lead insulation.
  2. Poor lead termination, such as a poor contact or a short to adjacent connection or surface.
  3. Shorted or open motor leads, or other external leads.
  4. Foreign matter or interference behind the PC boards.
- c. If PC board is visibly damaged mechanically, inspect for cause, then remedy before installing a replacement PC board.

If there is damage to the PC board or if replacing PC board corrects problem, return it to the local Lincoln Electric Field Service Shop.

### CAUTION

If for any reason you do not understand the test procedures or are unable to perform the tests/repairs safely, contact your **Local Lincoln Authorized Field Service Facility** for technical troubleshooting assistance before you proceed.

---

## Protection PC Board

The protection PC Board is located on the back of the control box. It protects the PC Board from electrical noise. Most of the circuits on the Protection board are straight through connections. The board can be checked out in the field with a continuity tester or an ohmmeter. A copy of the DC-650 PRO wiring diagram is needed also. All circuits should show continuity, or nearly zero ohms resistance, from input to output. Inputs and outputs can be identified by the common lead number suffixes on the wires connected to the Protection PC Board. For example, lead 75 on the input side is common with lead 375A on the output side. Lead 208 is common with 308, lead 209 is common with 309 and 309A, etc.

## Snubber PC Board

The snubber PC Board is located on the main rectifier. Circuits on this board protect the SCR's from high transient voltages. Failures on this board should be very rare. The only way to check the seven circuits on this board is to check each circuit, one at a time, using an ohmmeter, preferably an analog ohmmeter on the X10 scale. The first step is to connect one lead of the ohmmeter to the center plate of the rectifier assembly. This is the cathode connection for SCR's 1 through 6. Next, disconnect the Snubber board lead that goes to the anode of SCR1. Connect the other ohmmeter lead to this snubber lead. The ohmmeter should show a low resistance initially, then swing towards high resistance if the snubber is good. Repeat this with SCR's 2 through 6, each time testing just one Snubber lead. Lastly, disconnect the snubber lead that goes to the cathode of SCR7, and perform the same test. The ohmmeter action should be the same for each SCR on the bridge.

## Output Bypass PC Boards

One of these boards is mounted to each output terminal. Each board prevents high frequency energy and electrical noise from entering the DC-650 PRO. Again, failures of these boards should be very rare. The only way to inspect these boards is visually. Inspect each board, looking for burnt traces or components.

## Control PC Board

This board, located inside the control box, is the heart of the machine. All welding output is controlled by this board. The Meter boards receive their information from the Control board as well. Very little external diagnostic work can be performed on this board.

If one control or function of the machine does not appear to be working, it is best to trace out the wiring associated with that function, switch or potentiometer all the way back to the Control board with an ohmmeter. If all check out there, verify that the following voltages are present at the output of the auxiliary transformer, T3.

Auxiliary Transformer (T3) Secondary Lead Color	Plug P8 Locations	Approximate Voltage
Red to Red	7 to 9	36V AC
Red to White	7 to 8	18V AC
Yellow to Yellow	1 to 2	10V AC
Black to Black	5 to 6	24V AC
Orange to Orange	3 to 4	18V AC

Often, replacement with a known good board is the best service method. Remove the board that is suspected to be defective. Carefully look over the board, checking for burnt traces or components. If none are found, install the known good board. If the trouble goes away, reinstall the suspected bad board to confirm that the board was indeed at fault. If the problem is now gone with the original board installed, the problem is probably with one of the leads or connectors going to the board.

## Meter PC Board

Both the Voltmeter and the Ammeter PC boards are identical. They both operate as display boards, displaying numbers sent to them by the Control PC board. The Meter boards do not make voltage or current measurements; the Control Board performs those functions.

If both meter boards are dark, (not lighted) chances are that either the secondary thermostat is open (see "Thermostatic Protection" section), the auxiliary transformer T3 is defective (see "Control P.C. Board" section) or the Control board is defective.

If only one board is dark, make sure the machine is in a mode where both boards are supposed to light. There are certain modes where one board or the other is supposed to be dark. To check this, place the mode switch in the SMAW mode, and set the Output Control switch to "On". Both meters should be lit. If one board is still dark, that board may be defective. The best way to check this is to switch the bad board with the other working Meter board right next to it. Replace the defective board.

## CAUTION

If for any reason you do not understand the test procedures or are unable to perform the tests/repairs safely, contact your **Local Lincoln Authorized Field Service Facility** for technical troubleshooting assistance before you proceed.

# DC-650 PRO WIRING DIAGRAM

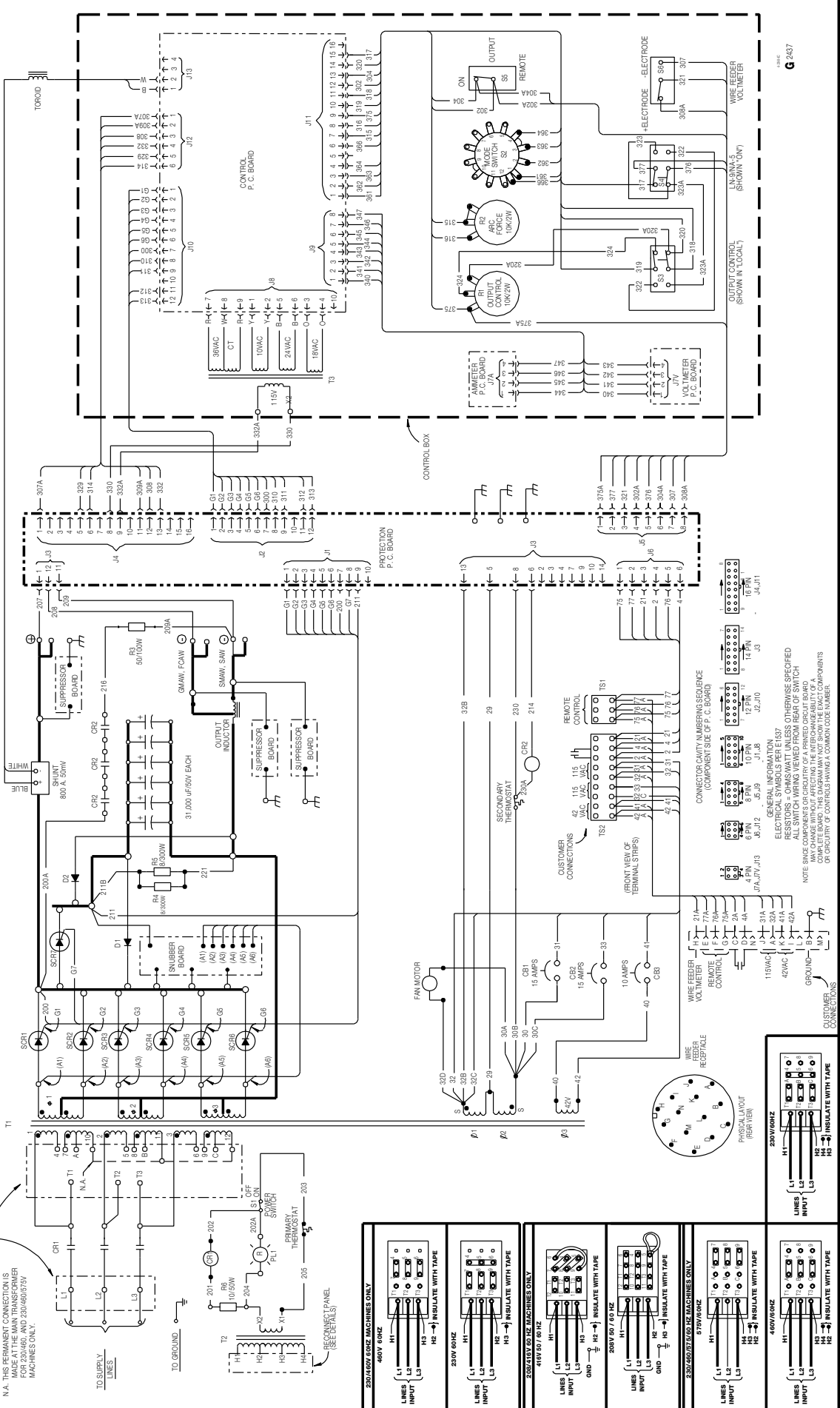

**NOTE:** This diagram is for reference only. It may not be accurate for all machines covered by this manual. The specific diagram for a particular code is pasted inside the machine on one of the enclosure panels. If the diagram is illegible, write to the Service Department for a replacement. Give the equipment code number..

# DIMENSION PRINTS

## DC-650 PRO WITH A K817 UNDERCARRIAGE

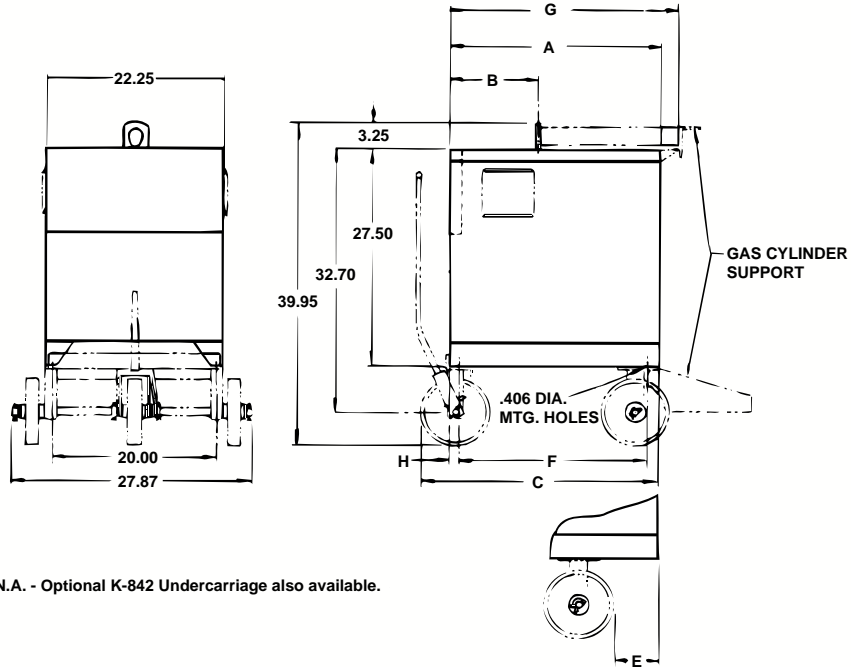

N.A. - Optional K-842 Undercarriage also available.

INCHES	38.00	20.24	40.59	4.75	29.93	39.07	.94	N.A.
(CM)	(96.5)	(51.4)	(103.1)	(12.1)	(76.0)	(99.2)	(2.4)	
UNITS	A	B	C	E	F	G	H	NOTE

## DC-650 PRO WITH A K842 UNDERCARRIAGE

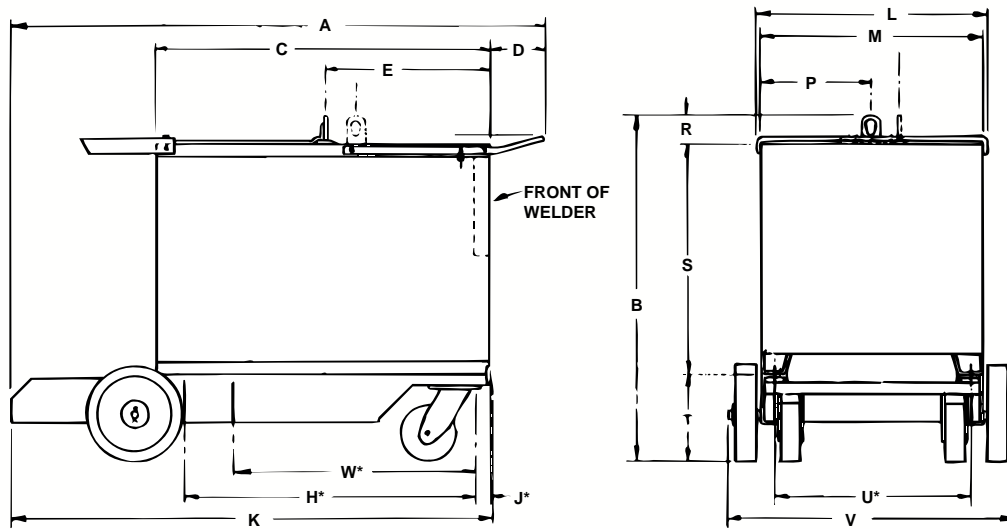

\* LOCATION OF .406 DIA. MOUNTING HOLES

INCHES	54.91	37.86	38.00	5.19	20.24	36.12	.94	49.89	23.28	22.25	11.12	3.25	27.50
(CM)	(139.5)	(96.2)	(96.5)	(13.2)	(51.4)	(91.7)	(2.4)	(126.7)	(59.1)	(56.5)	(28.2)	(8.2)	(69.9)
UNITS	A	B	C	D	E	H	J	K	L	M	P	R	S
INCHES	7.11	20.00	27.65	29.93									
(CM)	(18.1)	(50.8)	(70.2)	(76.0)									
UNITS	T	U	V	W									

**PARTS LIST FOR**

**DC-650 PRO**

**AND**

**DC-750**

**This parts list is provided as an informative guide only.**

**This information was accurate at the time of printing. However, since these pages are regularly updated in Lincoln Electric's official Parts Book (BK-34), always check with your Lincoln parts supplier for the latest parts**

11-1-96

# NOTES

---



<b>WARNING</b>	<ul style="list-style-type: none"> <li>● Do not touch electrically live parts or electrode with skin or wet clothing.</li> <li>● Insulate yourself from work and ground.</li> </ul>	<ul style="list-style-type: none"> <li>● Keep flammable materials away.</li> </ul>	<ul style="list-style-type: none"> <li>● Wear eye, ear and body protection.</li> </ul>
Spanish <b>AVISO DE PRECAUCION</b>	<ul style="list-style-type: none"> <li>● No toque las partes o los electrodos bajo carga con la piel o ropa mojada.</li> <li>● Aislese del trabajo y de la tierra.</li> </ul>	<ul style="list-style-type: none"> <li>● Mantenga el material combustible fuera del área de trabajo.</li> </ul>	<ul style="list-style-type: none"> <li>● Protéjase los ojos, los oídos y el cuerpo.</li> </ul>
French <b>ATTENTION</b>	<ul style="list-style-type: none"> <li>● Ne laissez ni la peau ni des vêtements mouillés entrer en contact avec des pièces sous tension.</li> <li>● Isolez-vous du travail et de la terre.</li> </ul>	<ul style="list-style-type: none"> <li>● Gardez à l'écart de tout matériel inflammable.</li> </ul>	<ul style="list-style-type: none"> <li>● Protégez vos yeux, vos oreilles et votre corps.</li> </ul>
German <b>WARNUNG</b>	<ul style="list-style-type: none"> <li>● Berühren Sie keine stromführenden Teile oder Elektroden mit Ihrem Körper oder feuchter Kleidung!</li> <li>● Isolieren Sie sich von den Elektroden und dem Erdboden!</li> </ul>	<ul style="list-style-type: none"> <li>● Entfernen Sie brennbares Material!</li> </ul>	<ul style="list-style-type: none"> <li>● Tragen Sie Augen-, Ohren- und Körperschutz!</li> </ul>
Portuguese <b>ATENÇÃO</b>	<ul style="list-style-type: none"> <li>● Não toque partes elétricas e electrodos com a pele ou roupa molhada.</li> <li>● Isole-se da peça e terra.</li> </ul>	<ul style="list-style-type: none"> <li>● Mantenha inflamáveis bem guardados.</li> </ul>	<ul style="list-style-type: none"> <li>● Use proteção para a vista, ouvido e corpo.</li> </ul>
Japanese <b>注意事項</b>	<ul style="list-style-type: none"> <li>● 通電中の電気部品、又は溶材にヒフやぬれた布で触れないこと。</li> <li>● 施工物やアースから身体が絶縁されている様にして下さい。</li> </ul>	<ul style="list-style-type: none"> <li>● 燃えやすいものの側での溶接作業は絶対にしてはなりません。</li> </ul>	<ul style="list-style-type: none"> <li>● 目、耳及び身体に保護具をして下さい。</li> </ul>
Chinese <b>警告</b>	<ul style="list-style-type: none"> <li>● 皮膚或濕衣物切勿接觸帶電部件及鎢條。</li> <li>● 使你自已與地面和工件絕緣。</li> </ul>	<ul style="list-style-type: none"> <li>● 把一切易燃物品移離工作場所。</li> </ul>	<ul style="list-style-type: none"> <li>● 佩戴眼、耳及身體勞動保護用具。</li> </ul>
Korean <b>위험</b>	<ul style="list-style-type: none"> <li>● 전도체나 용접봉을 젖은 헝겍 또는 피부로 절대 접촉치 마십시오.</li> <li>● 모재와 접지를 접촉치 마십시오.</li> </ul>	<ul style="list-style-type: none"> <li>● 인화성 물질을 접근시키지 마십시오.</li> </ul>	<ul style="list-style-type: none"> <li>● 눈, 귀와 몸에 보호장구를 착용하십시오.</li> </ul>
Arabic <b>تحذير</b>	<ul style="list-style-type: none"> <li>● لا تلمس الاجزاء التي يسري فيها التيار الكهربائي أو الألكترود بجلد الجسم أو بالملابس المبللة بالماء.</li> <li>● ضع عازلا على جسمك خلال العمل.</li> </ul>	<ul style="list-style-type: none"> <li>● ضع المواد القابلة للاشتعال في مكان بعيد.</li> </ul>	<ul style="list-style-type: none"> <li>● ضع أدوات وملابس واقية على عينيك وأذنيك وجسمك.</li> </ul>

**READ AND UNDERSTAND THE MANUFACTURER'S INSTRUCTION FOR THIS EQUIPMENT AND THE CONSUMABLES TO BE USED AND FOLLOW YOUR EMPLOYER'S SAFETY PRACTICES.**

**SE RECOMIENDA LEER Y ENTENDER LAS INSTRUCCIONES DEL FABRICANTE PARA EL USO DE ESTE EQUIPO Y LOS CONSUMIBLES QUE VA A UTILIZAR, SIGA LAS MEDIDAS DE SEGURIDAD DE SU SUPERVISOR.**

**LISEZ ET COMPRENEZ LES INSTRUCTIONS DU FABRICANT EN CE QUI REGARDE CET EQUIPMENT ET LES PRODUITS A ETRE EMPLOYES ET SUIVEZ LES PROCEDURES DE SECURITE DE VOTRE EMPLOYEUR.**

**LESEN SIE UND BEFOLGEN SIE DIE BETRIEBSANLEITUNG DER ANLAGE UND DEN ELEKTRODENEINSATZ DES HERSTELLERS. DIE UNFALLVERHÜTUNGSVORSCHRIFTEN DES ARBEITGEBERS SIND EBENFALLS ZU BEACHTEN.**



			
<ul style="list-style-type: none"> <li>● Keep your head out of fumes.</li> <li>● Use ventilation or exhaust to remove fumes from breathing zone.</li> </ul>	<ul style="list-style-type: none"> <li>● Turn power off before servicing.</li> </ul>	<ul style="list-style-type: none"> <li>● Do not operate with panel open or guards off.</li> </ul>	<b>WARNING</b>
<ul style="list-style-type: none"> <li>● Los humos fuera de la zona de respiración.</li> <li>● Mantenga la cabeza fuera de los humos. Utilice ventilación o aspiración para gases.</li> </ul>	<ul style="list-style-type: none"> <li>● Desconectar el cable de alimentación de poder de la máquina antes de iniciar cualquier servicio.</li> </ul>	<ul style="list-style-type: none"> <li>● No operar con panel abierto o guardas quitadas.</li> </ul>	Spanish <b>AVISO DE PRECAUCION</b>
<ul style="list-style-type: none"> <li>● Gardez la tête à l'écart des fumées.</li> <li>● Utilisez un ventilateur ou un aspirateur pour ôter les fumées des zones de travail.</li> </ul>	<ul style="list-style-type: none"> <li>● Débranchez le courant avant l'entretien.</li> </ul>	<ul style="list-style-type: none"> <li>● N'opérez pas avec les panneaux ouverts ou avec les dispositifs de protection enlevés.</li> </ul>	French <b>ATTENTION</b>
<ul style="list-style-type: none"> <li>● Vermeiden Sie das Einatmen von Schweißrauch!</li> <li>● Sorgen Sie für gute Be- und Entlüftung des Arbeitsplatzes!</li> </ul>	<ul style="list-style-type: none"> <li>● Strom vor Wartungsarbeiten abschalten! (Netzstrom völlig öffnen; Maschine anhalten!)</li> </ul>	<ul style="list-style-type: none"> <li>● Anlage nie ohne Schutzgehäuse oder Innenschutzverkleidung in Betrieb setzen!</li> </ul>	German <b>WARNUNG</b>
<ul style="list-style-type: none"> <li>● Mantenha seu rosto da fumaça.</li> <li>● Use ventilação e exaustão para remover fumo da zona respiratória.</li> </ul>	<ul style="list-style-type: none"> <li>● Não opere com as tampas removidas.</li> <li>● Desligue a corrente antes de fazer serviço.</li> </ul>	<ul style="list-style-type: none"> <li>● Mantenha-se afastado das partes moventes.</li> <li>● Não opere com os painéis abertos ou guardas removidas.</li> </ul>	Portuguese <b>ATENÇÃO</b>
<ul style="list-style-type: none"> <li>● ヒュームから頭を離すようにして下さい。</li> <li>● 換気や排煙に十分留意して下さい。</li> </ul>	<ul style="list-style-type: none"> <li>● メンテナンス・サービスに取りかかる際には、まず電源スイッチを必ず切して下さい。</li> </ul>	<ul style="list-style-type: none"> <li>● パネルやカバーを取り外したままで機械操作をしないで下さい。</li> </ul>	Japanese <b>注意事項</b>
<ul style="list-style-type: none"> <li>● 頭部遠離煙霧。</li> <li>● 在呼吸區使用通風或排風器除煙。</li> </ul>	<ul style="list-style-type: none"> <li>● 維修前切斷電源。</li> </ul>	<ul style="list-style-type: none"> <li>● 儀表板打開或沒有安全罩時不準作業。</li> </ul>	Chinese <b>警告</b>
<ul style="list-style-type: none"> <li>● 얼굴로부터 용접가스를 멀리하십시오.</li> <li>● 호흡지역으로부터 용접가스를 제거하기 위해 가스제거기나 통풍기를 사용하십시오.</li> </ul>	<ul style="list-style-type: none"> <li>● 보수전에 전원을 차단하십시오.</li> </ul>	<ul style="list-style-type: none"> <li>● 관널이 열린 상태로 작동치 마십시오.</li> </ul>	Korean <b>위험</b>
<ul style="list-style-type: none"> <li>● ابعد رأسك بعيداً عن الدخان.</li> <li>● استعمل التهوية أو جهاز ضغط الدخان للخارج لكي تبعد الدخان عن المنطقة التي تتنفس فيها.</li> </ul>	<ul style="list-style-type: none"> <li>● اقطع التيار الكهربائي قبل القيام بأية صيانة.</li> </ul>	<ul style="list-style-type: none"> <li>● لا تشغيل هذا الجهاز اذا كانت الاغطية الحديدية الواقية ليست عليه.</li> </ul>	Arabic <b>تحذير</b>

**LEIA E COMPREENDA AS INSTRUÇÕES DO FABRICANTE PARA ESTE EQUIPAMENTO E AS PARTES DE USO, E SIGA AS PRÁTICAS DE SEGURANÇA DO EMPREGADOR.**

使う機械や溶材のメーカーの指示書をよく読み、まず理解して下さい。そして貴社の安全規定に従って下さい。

請詳細閱讀並理解製造廠提供的說明以及應該使用的銀焊材料，並請遵守貴方的有關勞動保護規定。

이 제품에 동봉된 작업지침서를 숙지하시고 귀사의 작업자 안전수칙을 준수하시기 바랍니다.

اقرأ بتعمق وافهم تعليمات المصنع المنتج لهذه المعدات والمواد قبل استعمالها واتبع تعليمات الوقاية لصاحب العمل.



• World's Leader in Welding and Cutting Products •

• Sales and Service through Subsidiaries and Distributors Worldwide •

Cleveland, Ohio 44117-1199 U.S.A. TEL: 216.481.8100 FAX: 216.486.1751 WEB SITE: [www.lincolnelectric.com](http://www.lincolnelectric.com)