



NA10334/ First Edition / June 2015

RT-AC1200 Wireless-ac1200 Dual Band Router



Setup Guide

ASUS Recycling/Takeback Services

ASUS recycling and takeback programs come from our commitment to the highest standards for protecting our environment. We believe in providing solutions for you to be able to responsibly recycle our products, batteries, other components, as well as the packaging materials. Please go to <http://csr.asus.com/english/Takeback.htm> for the detailed recycling information in different regions.

English	2
Français	7
Português	12
Español	17



Package contents

- RT-AC1200 wireless router
- Network cable (RJ-45)
- Warranty card
- AC adapter
- Quick Start Guide
- Setup Guide



NOTE: If any of the items is damaged or missing, contact your retailer.

A quick look at your RT-AC1200

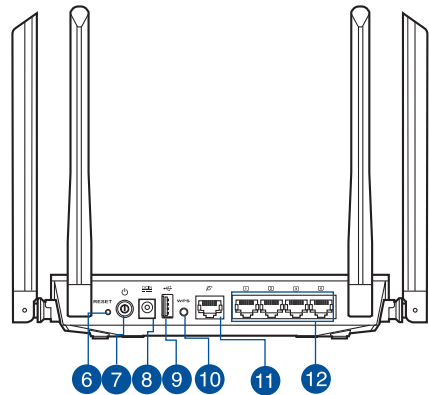
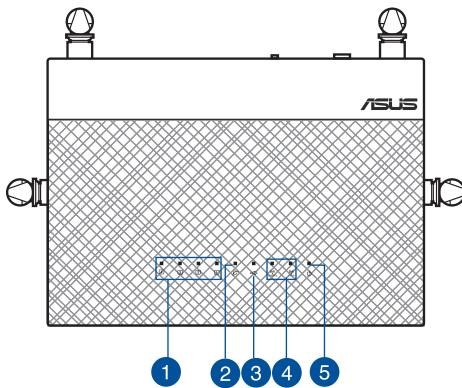

1) LAN 1~4 LED	5) Power LED	9) USB2.0 port
2) WAN (Internet) LED	6) Reset button	10) WPS button
3) USB2.0 LED	7) Power switch	11) WAN (Internet) port
4) 2.4GHz / 5GHz LED	8) Power (DC-IN) port	12) LAN 1~4 ports



CAUTION! DO NOT throw this product in municipal waste. This product has been designed to enable proper reuse of parts and recycling. This symbol of the crossed out wheeled bin indicates that the product (electrical and electronic equipment) should not be placed in municipal waste. Check local regulations for disposal of electronic products.



Setting up a Home Network - Router Mode

1. Extend the antennas.

Position the antennas for the best Wi-Fi performances.

2. Prepare your modem.

Unplug your modem's power supply. Remove the battery if your modem has a backup battery.

3. Connect your modem.

Connect the modem to your router's WAN port using a network cable. Put the backup battery back and replug your modem to a power outlet.

4. Power ON the router.

Both 2.4GHz and 5GHz LED lights are on when the router is ready.

5. Connect a computer.

Connect a computer to the network wired or wirelessly.

You can set up your wireless router via wired or wireless connection:

Wired: Connect the network cable (3) from your modem to the blue Ethernet port on your router. Connect another network cable (2) from your computer to the yellow Ethernet port on your router.

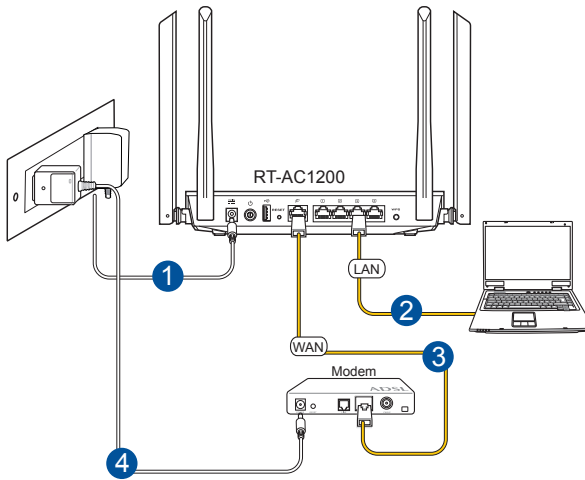



English

Wireless: Connect the network cable (2) from your modem to the blue Ethernet port on your router. Turn on the Wi-Fi function of your computer or other devices.

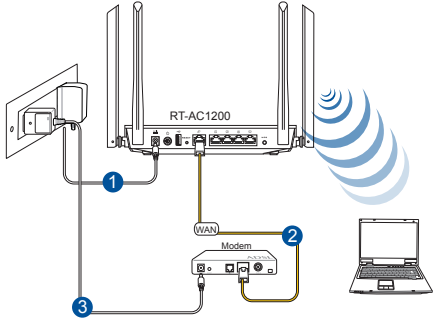

Use the default network name (SSID) and password, which is located at the back of your router, to connect to the network.

- SSID (2.4GHz) xxxxxxxxxxxxxx
- Password (2.4GHz) xxxxxxxxxx
- SSID (5GHz) xxxxxxxxxxxxxx
- Password (5GHz) xxxxxxxxxx

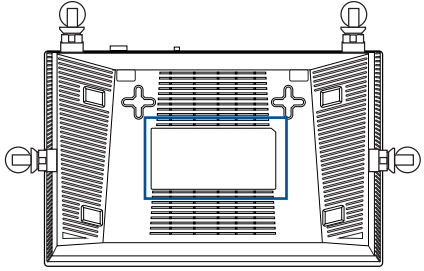

6. Log into the router.

Once connected, the web GUI launches automatically when you open a web browser. If it does not auto-launch, enter <http://router.asus.com> or <http://192.168.50.1>. Enter the default username and password to log in to router's web GUI.

7. Change the default settings.

For better security for your wireless network, change the default settings and assign unique network names and password. Take note of your wireless settings as you complete the router setup.





Frequently Asked Questions (FAQs)

The client cannot establish a wireless connection with the router.

Out of Range:

- Put the router closer to the wireless client.
- Try to change the channel settings.

Authentication:

- Use wired connection to connect to the router.
- Check the wireless security settings.
- Press the Reset button at the rear panel for more than five seconds.

Cannot find the router:

- Press the Reset button at the rear panel for more than five seconds.
 - Check the setting in the wireless adapter such as SSID and encryption settings.
- * You can find the SSID and Password that are shown on the bottom of your router.

Cannot access the Internet via wireless LAN adapter.

- Move the router closer to the wireless client.
- Check whether the wireless adapter is connected to the correct wireless router.
- Check whether the wireless channel in use conforms to the channels available in your country/area.
- Check the encryption settings.
- Check if the ADSL or Cable connection is correct.
- Retry using another Ethernet cable.

Network name or encryption keys are forgotten.

- Try setting up the wired connection and configuring the wireless encryption again.
- Press the Reset button of the wireless router for more than five seconds.
- Factory default settings:

User name / Password:
admin / admin

IP address:
[http:// router.asus.com](http://router.asus.com) or <http://192.168.50.1>





Where can I find more information about the wireless router?

- Online FAQ site: <http://support-org.asus.com/faq>
- Technical Support site: <http://support-org.asus.com>
- Customer Hotline: Refer to the Support Hotline in this Setup Guide





Contenu de la boîte

- Routeur sans fil RT-AC1200
- Câble réseau (RJ-45)
- Carte de garantie
- Adaptateur secteur
- Guide de démarrage rapide
- Guide d'installation



REMARQUE: Contactez votre revendeur si l'un des éléments est manquant ou endommagé.

Aperçu rapide

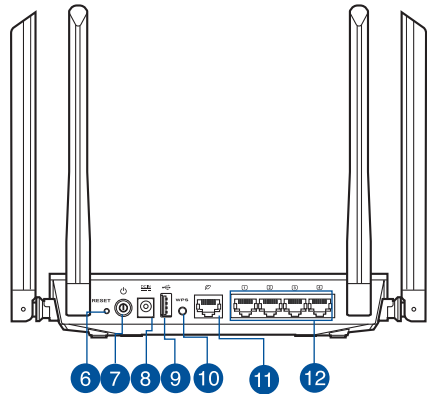
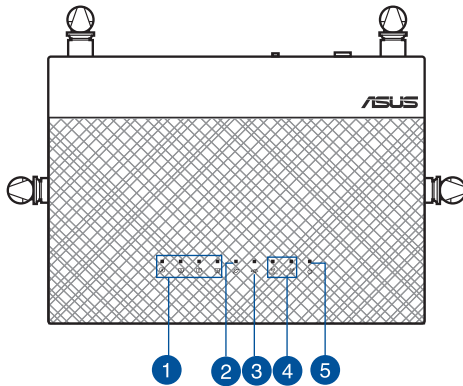

1) Réseau local 1~4 LED	5) Témoin d'alimentation	9) Ports USB 2.0
2) témoin réseau étendu (WAN)	6) Bouton de réinitialisation	10) Bouton WPS
3) Témoin de USB 2.0	7) Bouton d'alimentation	11) Port réseau étendu (Internet)
4) Témoin de bande 2.4GHz/5GHz	8) Prise d'alimentation (CC)	12) Ports LAN 1 ~ 4



PRÉCAUTION! NE PAS mettre ce produit au rebut avec les déchets municipaux. Ce produit a été conçu pour permettre une réutilisation et un recyclage appropriés des pièces. Le symbole représentant une benne à roues barrée indique que le produit (équipement électrique, électronique et ou contenant une batterie au mercure) ne doit pas être mis au rebut avec les déchets municipaux. Consultez les réglementations locales pour la mise au rebut des produits électroniques.



Configurer un réseau domestique en mode routeur

1. Positionnement des antennes.

Positionnez les antennes de telle sorte à optimiser la couverture du signal sans fil.

2. Préparation du modem

Débranchez le modem de sa prise électrique, et, si nécessaire, retirez la batterie de secours du modem.

3. Connexion le modem

Connectez le modem au port WAN (Internet) du routeur à l'aide d'un câble réseau. Remplacez, si nécessaire, la batterie de secours du modem et branchez ce dernier sur une prise électrique.

4. Mise en route du routeur

Le routeur est prêt lorsque les témoins lumineux dédiés aux bandes 2.4 GHz et 5 GHz sont allumés.

5. Connexion d'un ordinateur

Connectez le routeur à un ordinateur par le biais d'un câble réseau ou du réseau sans fil.

Connexion filaire : Utilisez un câble réseau (3) pour relier votre modem au port Ethernet bleu du routeur. Utilisez un autre câble (2) pour relier votre ordinateur au port Ethernet jaune du routeur.

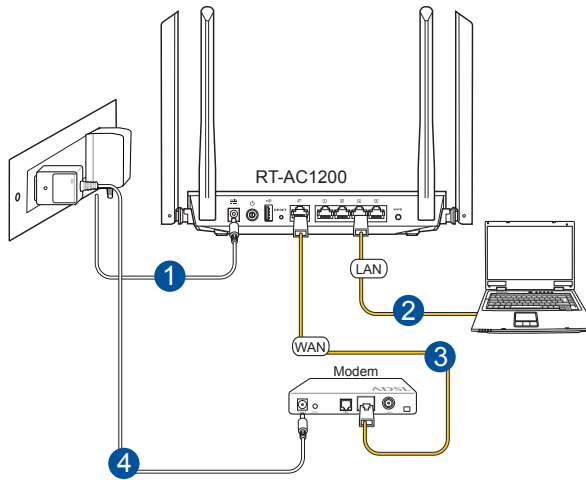



Connexion sans fil : Utilisez un câble réseau (2) pour relier votre modem au port Ethernet bleu du routeur. Activez la fonction Wi-Fi de votre ordinateur ou de tout autre appareil que vous souhaitez connecter.

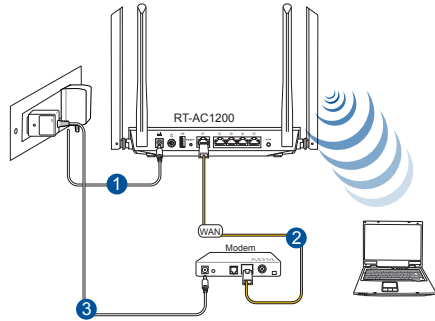

Utilisez le SSID (nom du réseau sans fil) et le mot de passe par défaut (localisés à l'arrière du routeur) pour établir une connexion au réseau.

SSID (2.4GHz) xxxxxxxxxxxxxxxx

Mot de passe (2.4GHz) xxxxxxxxxxxx

SSID (5GHz) xxxxxxxxxxxxxxxx

Mot de passe (5GHz) xxxxxxxxxxxx

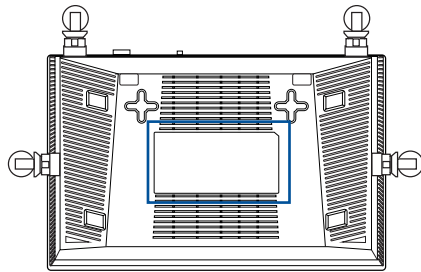

6. Connexion à l'interface de gestion du routeur

L'interface de gestion du routeur s'affiche automatiquement lors de l'ouverture de votre explorateur Internet. Si ce n'est pas le cas, entrez <http://router.asus.com> ou <http://192.168.50.1> dans la barre d'adresse. Entrez le nom d'utilisateur et le mot de passe par défaut pour vous connecter à l'interface de gestion du routeur.

7. Modification des paramètres par défaut du routeur

Pour garantir la sécurité du réseau sans fil, modifiez les paramètres par défaut du routeur tels que le nom (SSID) et le mot de passe d'accès au réseau sans fil.





Foire aux questions (FAQ)

Le client ne peut pas établir de connexion sans fil avec le routeur.

Hors de portée :

- Rapprochez le client du routeur.
- Essayez d'autres paramètres de canaux.

Authentification :

- Utilisez une connexion filaire pour vous connecter au routeur.
- Vérifiez les paramètres de sécurité sans fil.
- Appuyez sur le bouton Reset situé sur l'arrière du routeur pendant plus de 5 secondes

Routeur introuvable :

- Appuyez sur le bouton de réinitialisation situé sur l'arrière du routeur pendant plus de 5 secondes.
- Vérifiez les paramètres SSID et de chiffrement de l'adaptateur sans fil.

Impossible d'accéder à Internet via un adaptateur sans fil local.

- Rapprochez le client du routeur.
- Vérifiez que l'adaptateur sans fil est connecté au bon routeur sans fil.
- Vérifiez que le canal sans fil que vous utilisez appartient aux canaux disponibles dans votre pays/région.
- Vérifiez les paramètres de chiffrement.
- Vérifiez la connexion ADSL ou au Câble.
- Utilisez un autre câble Ethernet.

Si la LED "LINK" du modem ADSL clignote ou reste éteinte en permanence, cela signifie alors qu'il n'est pas possible d'accéder à Internet - le routeur n'est pas en mesure d'établir une connexion au réseau ADSL.

- Vérifiez que les câbles sont correctement connectés.
- Débranchez le câble d'alimentation du modem. Patientez quelques secondes, puis reconnectez le câble.





- Si la LED ADSL clignote ou reste éteinte en permanence, contactez votre fournisseur d'accès ADSL.

Nom de réseau et/ou clé de cryptage oubliés.

- Essayez de configurer une connexion filaire et configurez à nouveau les paramètres de chiffrement sans fil.
- Appuyez sur le bouton de réinitialisation situé sur l'arrière du routeur pendant plus de 5 secondes.
- Paramètres par défaut :

Nom d'utilisateur / Mot de passe : admin / admin	Adresse IP : 192.168.1.1	SSID : ASUS
--	------------------------------------	--------------------

Où puis-je obtenir plus d'informations sur le routeur sans fil ?

- Manuel d'utilisation contenu dans le CD de support
- FAQ en ligne : <http://support-org.asus.com/faq>
- Site de support technique: <http://support-org.asus.com>
- Hotline : consultez la liste des centres d'appels ASUS en fin de guide.



Conteúdo da embalagem

- RT-AC1200
- Cabo de rede (RJ-45)
- Cartão de garantia
- Transformador
- Guia de consulta rápida
- Guia de configuração



NOTA: Caso algum item esteja danificado ou em falta, contacte o seu revendedor.

A quick look at your RT-AC1200

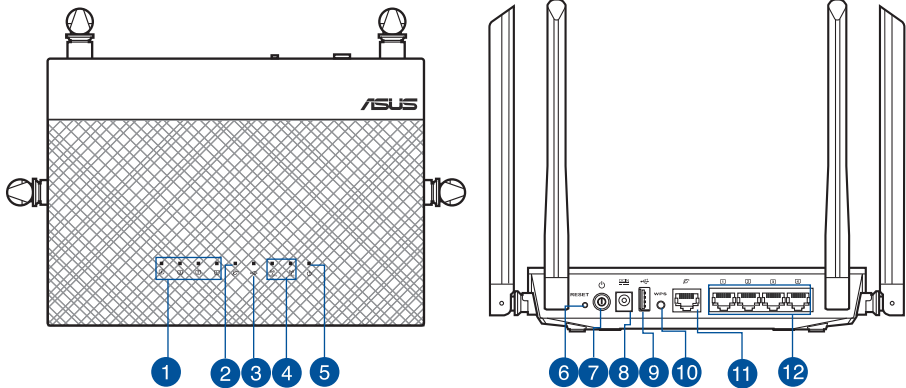

1) LED 1 a 4 da LAN	5) LED de Alimentação	9) Portas USB 2.0
2) LED WAN (Internet)	6) Vypínaè	10) Botão WPS
3) LED USB 2.0	7) Botão WPS	11) Portas WAN (Internet)
4) LED 2.4GHz / LED 5GHz	8) Porta de alimentação (Entrada DC)	12) Portas 1 a 4 da LAN



ATENÇÃO! NÃO deite o este produto no contentor do lixo. Este produto foi concebido para permitir a reutilização e reciclagem dos seus componentes. O símbolo do caixote do lixo com uma cruz por cima indica que o produto (equipamento eléctrico e electrónico, e com baterias contendo mercúrio) não deve ser colocado junto com o lixo doméstico. Consulte os regulamentos locais relativamente à eliminação de equipamentos electrónicos.



Configurar uma rede doméstica - Modo de router

1. Abrir as antenas.

Posicione as antenas de forma a obter o melhor desempenho de Wi-Fi.

2. Preparar o modem.

Desligue a fonte de alimentação do modem. Remova a bateria de reserva do modem, caso este possua uma.

3. Ligar o modem.

Ligue o modem à porta WAN do router através de um cabo de rede. Volte a colocar a bateria de reserva e ligue novamente o modem a um tomada elétrica.

4. Ligar o router.

Ambas as luzes LED de 2,4 GHz e 5 GHz acendem quando o router estiver preparado.

5. Ligar um computador.

Ligue um computador à rede com ou sem fios.

Com fios: Ligue o cabo de rede (3) do seu modem à porta Ethernet azul do seu router. Ligue o outro cabo de rede (2) do seu computador à porta Ethernet amarela do seu router.

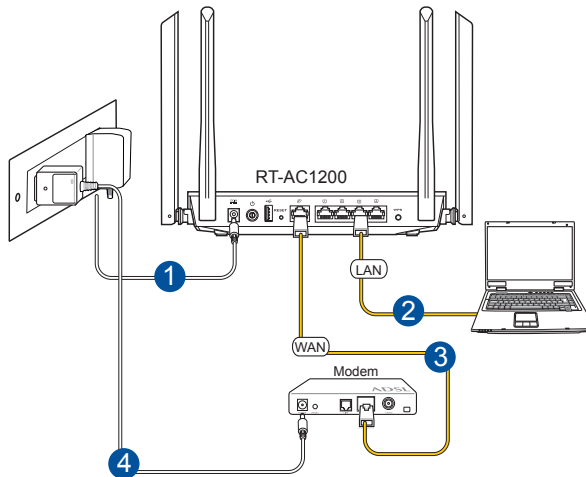

Sem fios: Ligue o cabo de rede (2) do seu modem à porta Ethernet azul do seu router. Ligue a função Wi-Fi do seu computador ou outros dispositivos.

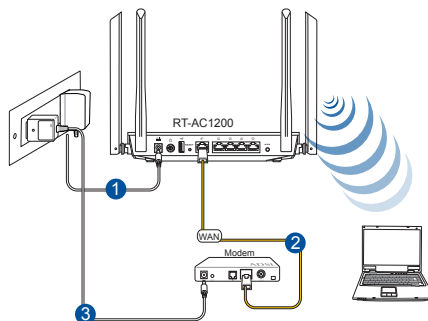

Utilize o nome de rede (SSID) e palavra-passe predefinidos, localizados na traseira do router, para efetuar a ligação à rede.

SSID (2.4GHz) xxxxxxxxxxxxxx

Palavra-passe (2.4GHz) xxxxxxxxxx

SSID (5GHz) xxxxxxxxxxxxxx

Palavra-passe (5GHz) xxxxxxxxxx

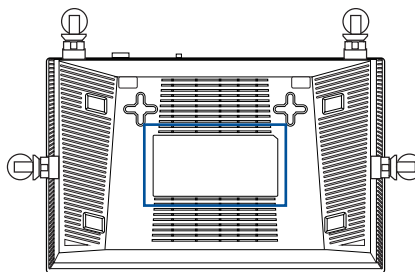

6. Iniciar sessão no router.

Após a ligação, a interface web irá abrir automaticamente quando abrir um navegador web. Se não abrir automaticamente, introduza <http://router.asus.com> ou <http://192.168.50.1>. Introduza o nome de utilizador e palavra-passe predefinidos para iniciar sessão na interface Web do router.

7. Alterar os valores predefinidos.

Para obter maior segurança na sua rede sem fios, altere os valores predefinidos e atribua um nome de rede e palavra-passe únicos. Tome nota das definições da ligação sem fios quando concluir a configuração do router.



Perguntas Frequentes (FAQ)

O cliente não consegue estabelecer uma ligação sem fios com o router.

Fora de alcance:

- Coloque o router mais próximo do cliente sem fios.
- Experimente alterar as definições do canal.

Autenticação:

- Utilize uma ligação com fios para ligar ao router.
- Verifique as definições de segurança da ligação sem fios.
- Prima o botão Reset (Repor) no painel traseiro durante mais de cinco segundos

Não é possível localizar o router:

- Prima o botão Reset (Repor) no painel traseiro durante mais de cinco segundos.
- Verifique as definições na placa sem fios como, por exemplo, as definições SSID e de encriptação. **Cannot find the router:**

Não é possível aceder à Internet através da LAN sem fios

- Coloque o router mais próximo do cliente sem fios.
- Verifique se a placa sem fios está ligada ao router sem fios correcto.
- Verifique se o canal da função sem fios em utilização está em conformidade com os canais disponíveis no seu país/na sua área.
- Verifique as definições de encriptação.
- Verifique se a ligação por ADSL ou por cabo está correcta.
- Volte a tentar utilizando um outro cabo Ethernet.

Se o LED "LINK" do modem ADSL estiver intermitente ou desligado, é sinal de que não é possível aceder à Internet – o router não consegue estabelecer ligação através da rede ADSL.

- Certifique-se de que todos os cabos estão devidamente ligados.
- Desligue o cabo de alimentação do modem ADSL ou do modem por cabo. Aguarde alguns minutos e volte a ligar o cabo.



- Se o LED do modem ADSL continuar a piscar ou permanecer desligado, contacte o seu fornecedor de serviços.

O nome da rede ou as chaves de segurança foram esquecidas.

- Tente configurar a ligação com fios e configure novamente as definições de encriptação.
- Pressione o botão Repor durante mais de cinco segundos para repor ou restaurar as predefinições do sistema.
- Predefinições:

Nome de utilizador / Palavra-passe: admin / admin	Endereço IP: 192.168.1.1	SSID: ASUS
---	------------------------------------	-------------------

Where can I find more information about the wireless router?

Onde posso encontrar mais informações acerca do router sem fios?

- Manual do utilizador incluído no CD de suporte
- Site de Perguntas Frequentes Online: <http://support-org.asus.com/faq>
- Site de Apoio Técnico: <http://support-org.asus.com/>
- Linha de Apoio ao Cliente: Consulte a Linha de Apoio ao Cliente no Guia suplementar.



Contenido del paquete

- RT-AC1200
- Cable de red (RJ-45)
- Tarjeta de garantía
- Adaptador de CA
- Guía de inicio rápido
- Guía de instalación



NOTA: Si alguno de los artículos falta o se encuentra dañado, póngase en contacto con su distribuidor.

Un vistazo rápido a su RT-AC1200

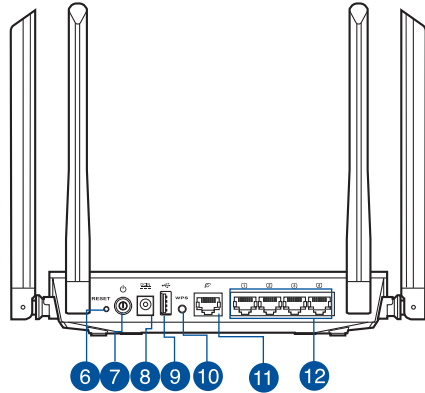
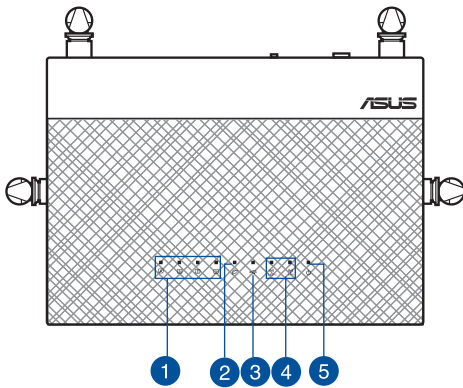

1) LED LAN 1~4	5) LED de alimentación	9) USB 2.0 Puertos
2) WAN LED (Internet)	6) Botón Restablecer	10) Botón WPS
3) LED de USB 2.0	7) Vypínaè	11) WAN (Internet) puertos
4) LED de 2.4 GHz / LED de 5GHz	8) Puerto de alimentación (DC-IN)	12) LAN 1~4 puertos



PRECAUCIÓN! NO arroje el este producto a la basura municipal. Este producto se ha diseñado para permitir la reutilización adecuada y el reciclaje de sus componentes. El símbolo de la papelera tachada indica que el producto y sus componentes (eléctricos, electrónicos y pila de botón) no se debe arrojar a la basura municipal. Consulte la normativa local aplicable para deshechos electrónicos.



Configurar una red doméstica - Modo Router

1. Extienda las antenas.

Posicione las antenas para conseguir el mejor rendimiento Wi-Fi.

2. Prepare el módem.

Desenchufe la fuente de alimentación del módem. Quite la batería si el módem tiene una batería de reserva.

3. Conecte el módem.

Conecte el módem al puerto WAN del router mediante un cable de red. Vuelva a colocar la batería de reserva y a enchufar el módem a una toma de corriente eléctrica.

4. ENCIENDA el router.

Tanto a la luz de 2,4 GHz como la de 5 GHz se iluminarán cuando el router esté preparado.

5. Conecte su PC.

Conecte su PC a la red mediante un cable o de forma inalámbrica.

Cableada: conecte el cable de red (3) desde su módem al puerto Ethernet azul del router. Conecte otro cable de red (2) desde su PC al puerto Ethernet amarillo del router.

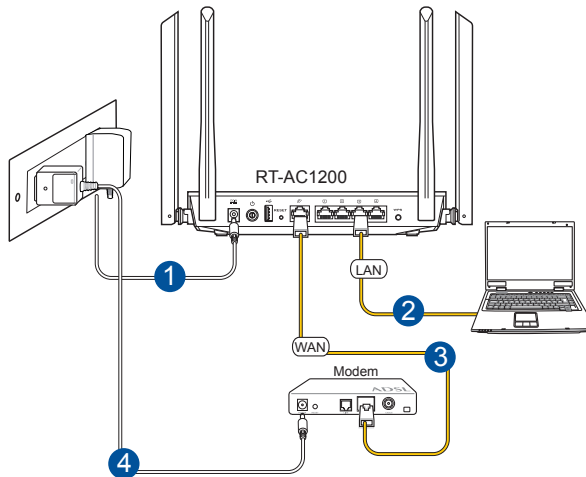



Inalámbrica: conecte el cable de red (2) desde su módem al puerto Ethernet azul del router. Active la funcionalidad Wi-Fi de su PC u otros dispositivos.

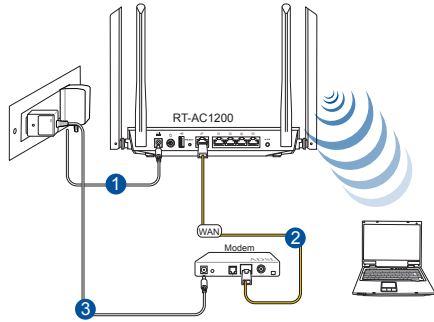

Para conectarse a la red, utilice el nombre de red (SSID) y la contraseña predeterminados que se encuentran en la parte posterior del router.

SSID (2.4GHz) xxxxxxxxxxxxxx

Contraseña (2.4GHz) xxxxxxxxxx

SSID (5GHz) xxxxxxxxxxxxxx

Contraseña (5GHz) xxxxxxxxxx

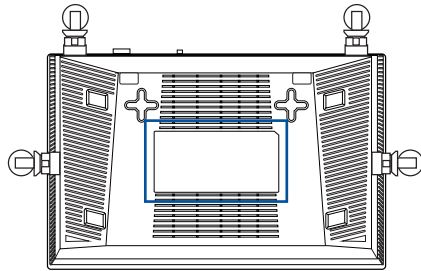

6. Inicie sesión en el enrutador.

Una vez conectado, la GUI Web se inicia automáticamente cuando abre un explorador Web. Si no se inicia automáticamente, escriba <http://router.asus.com> o <http://192.168.50.1>. Escriba el nombre de usuario y la contraseña predeterminados para iniciar sesión en la GUI Web del router.

7. Cambie la configuración predeterminada.

Para mayor seguridad para la red inalámbrica, cambie la configuración predeterminada y asigne nombres y contraseñas de red únicos. Anote la configuración inalámbrica cuando complete la configuración del router.





Preguntas más frecuentes (P+F)

El cliente no puede establecer una conexión inalámbrica con el router.

Se encuentra fuera del alcance de la red:

- Coloque el router más cerca del cliente inalámbrico.
- Intente cambiar el canal.

Autenticación:

- Utilice la conexión por cable para conectarse al router.
- Consulte la configuración de seguridad inalámbrica.
- Presione el botón Restablecer situado en el panel posterior durante más de cinco segundos.

No se encuentra el router:

- Mantenga pulsado el botón **Reset (Restablecer)** durante más de cinco segundos.
- Consulte la configuración del adaptador inalámbrico, como el identificador SSID y la configuración de cifrado.

No se puede acceder a Internet por medio del adaptador de red LAN inalámbrica

- Coloque el router más cerca del cliente inalámbrico.
- Compruebe si el adaptador inalámbrico está conectado al router inalámbrico correcto.
- Check the encryption settings.
- Compruebe si el canal inalámbrico en uso se puede utilizar en su zona/país.
- Consulte la configuración de cifrado.
- Consulte si la conexión de ADSL o Cable es correcta.
- Vuelva a intentarlo utilizando otro cable Ethernet.

Si el indicador luminoso "LINK" del Módem ADSL permanece iluminado o apagado, significa que no es posible acceder a Internet; el router no puede establecer una conexión con la red ADSL.

- Asegúrese de que todos los cables estén conectados correctamente.
- Desconecte el cable de alimentación del módem de ADSL o Cable, espere unos





- minutos y vuelva a conectarlo.
- Si el indicador ADSL continúa parpadeando o permanece APAGADO, póngase en contacto con su proveedor de servicios de ADSL.

He olvidado el nombre de la red o las claves de cifrado.

- Intente establecer la conexión por cable y configurar de nuevo el cifrado inalámbrico.
- Presione el botón Reiniciar del router inalámbrico durante más de cinco segundos.
- Valores predeterminados de fábrica:

Nombre de usuario / Contraseña: admin / admin	Dirección IP: 192.168.1.1	SSID: ASUS
--	-------------------------------------	-------------------

¿De qué otros recursos dispongo para obtener más información acerca del router inalámbrico?

- El manual del usuario que incluye el CD de soporte
- El sitio web de preguntas más frecuentes: <http://support-org.asus.com/faq>
- El sitio web de soporte técnico: <http://support-org.asus.com/>
- Línea Directa: Consulte el número de la línea telefónica de soporte técnico en esta Guía de instalación.

NOTICES

Federal Communications Commission Statement

This device complies with Part 15 of the FCC Rules. Operation is subject to the following two conditions:

- This device may not cause harmful interference.
- This device must accept any interference received, including interference that may cause undesired operation.

This equipment has been tested and found to comply with the limits for a class B digital device, pursuant to part 15 of the FCC Rules. These limits are designed to provide reasonable protection against harmful interference in a residential installation.

This equipment generates, uses and can radiate radio frequency energy and, if not installed and used in accordance with the instructions, may cause harmful interference to radio communications. However, there is no guarantee that interference will not occur in a particular installation. If this equipment does cause harmful interference to radio or television reception, which can be determined by turning the equipment off and on, the user is encouraged to try to correct the interference by one or more of the following measures:

- Reorient or relocate the receiving antenna.
- Increase the separation between the equipment and receiver.
- Connect the equipment into an outlet on a circuit different from that to which the receiver is connected.
- Consult the dealer or an experienced radio/TV technician for help.

WARNING! Any changes or modifications not expressly approved by the party responsible for compliance could void the user's authority to operate the equipment.

Prohibition of Co-location

This device and its antenna(s) must not be co-located or operating in conjunction with any other antenna or transmitter.

Safety Information:

To maintain compliance with FCC's RF exposure guidelines, this equipment should be installed and operated with minimum distance 20cm between the radiator and your body. Use on the supplied antenna.



Canada, Industry Canada (IC) Notices

This radio transmitter (3568A-DUAL-ROUTER) has been approved by industry Canada to operate with the maximum permissible gain and required antenna impedance for each antenna type indicated. Antenna types not included in this list, having a gain greater than the maximum gain indicated for that type, are strictly prohibited for use with this device.

Operation is subject to the following two conditions: (1) the device may not cause interference, and (2) this device must accept any interference, including interference that may cause undesired operation of the device.

Radio Frequency (RF) Exposure Information

This equipment complies with IC RSS-102 radiation exposure limits set forth for an uncontrolled environment. This equipment should be installed and operated with minimum distance 25cm between the radiator & your body.

Cet équipement est conforme aux limites d'exposition aux rayonnements IC établies pour un environnement non contrôlé. Cet équipement doit être installé et utilisé avec un minimum de 25 cm de distance entre la source de rayonnement et votre corps.

Canada, avis d'Industry Canada (IC)

Le présent appareil est conforme aux CNR d'Industrie Canada applicables aux appareils radio exempts de licence. L'exploitation est autorisée aux deux conditions suivantes: (1) l'appareil ne doit pas produire de brouillage, et (2) l'utilisateur de l'appareil doit accepter tout brouillage radioélectrique subi, même si le brouillage est susceptible d'en compromettre le fonctionnement.



Networks Global Hotline Information

Region	Country	Hotline Number	Service Hours	
Europe	Cyprus	800-92491	09:00-13:00 ; 14:00-18:00 Mon-Fri	
	France	0033-170949400	09:00-18:00 Mon-Fri	
	Germany	0049-1805010920		
		0049-1805010923 (component support)		09:00-18:00 Mon-Fri 10:00-17:00 Mon-Fri
		0049-2102959911 (Fax)		
	Hungary	0036-15054561	09:00-17:30 Mon-Fri	
	Italy	199-400089	09:00-13:00 ; 14:00-18:00 Mon-Fri	
	Greece	00800-44142044	09:00-13:00 ; 14:00-18:00 Mon-Fri	
	Austria	0043-820240513	09:00-18:00 Mon-Fri	
	Netherlands/ Luxembourg	0031-591570290	09:00-17:00 Mon-Fri	
	Belgium	0032-78150231	09:00-17:00 Mon-Fri	
	Norway	0047-2316-2682	09:00-18:00 Mon-Fri	
	Sweden	0046-858769407	09:00-18:00 Mon-Fri	
	Finland	00358-969379690	10:00-19:00 Mon-Fri	
	Denmark	0045-38322943	09:00-18:00 Mon-Fri	
	Poland	0048-225718040	08:30-17:30 Mon-Fri	
	Spain	0034-902889688	09:00-18:00 Mon-Fri	
	Portugal	00351-707500310	09:00-18:00 Mon-Fri	
	Slovak Republic	00421-232162621	08:00-17:00 Mon-Fri	
	Czech Republic	00420-596766888	08:00-17:00 Mon-Fri	
Switzerland-German	0041-848111010	09:00-18:00 Mon-Fri		
Switzerland-French	0041-848111014	09:00-18:00 Mon-Fri		
Switzerland-Italian	0041-848111012	09:00-18:00 Mon-Fri		
United Kingdom	0044-8448008340	09:00-17:00 Mon-Fri		
Ireland	0035-31890719918	09:00-17:00 Mon-Fri		
Russia and CIS	008-800-100-ASUS	09:00-18:00 Mon-Fri		
Ukraine	0038-0445457727	09:00-18:00 Mon-Fri		

Networks Global Hotline Information

Region	Country	Hotline Numbers	Service Hours
Asia-Pacific	Australia	1300-278788	09:00-18:00 Mon-Fri
	New Zealand	0800-278788	09:00-18:00 Mon-Fri
	Japan	0800-1232787	09:00-18:00 Mon-Fri
			09:00-17:00 Sat-Sun
		0081-570783886 (Non-Toll Free)	09:00-18:00 Mon-Fri
			09:00-17:00 Sat-Sun
	Korea	0082-215666868	09:30-17:00 Mon-Fri
	Thailand	0066-24011717 1800-8525201	09:00-18:00 Mon-Fri
	Singapore	0065-64157917 0065-67203835 (Repair Status Only)	11:00-19:00 Mon-Fri
			11:00-19:00 Mon-Fri
			11:00-13:00 Sat
	Malaysia	0060-320535077	10:00-19:00 Mon-Fri
	Philippine	1800-18550163	09:00-18:00 Mon-Fri
	India	1800-2090365	09:00-18:00 Mon-Sat
09:00-21:00 Mon-Sun			
Indonesia	0062-2129495000 500128 (Local Only)	09:30-17:00 Mon-Fri	
		9:30 – 12:00 Sat	
Vietnam	1900-555581	08:00-12:00	
		13:30-17:30 Mon-Sat	
Hong Kong	00852-35824770	10:00-19:00 Mon-Sat	
Americas	USA	1-812-282-2787	8:30-12:00 EST Mon-Fri
	Canada		9:00-18:00 EST Sat-Sun
	Mexico	001-8008367847	08:00-20:00 CST Mon-Fri
			08:00-15:00 CST Sat

Networks Global Hotline Information

Region	Country	Hotline Numbers	Service Hours
Middle East + Africa	Egypt	800-2787349	09:00-18:00 Sun-Thu
	Saudi Arabia	800-1212787	09:00-18:00 Sat-Wed
	UAE	00971-42958941	09:00-18:00 Sun-Thu
	Turkey	0090-2165243000	09:00-18:00 Mon-Fri
	South Africa	0861-278772	08:00-17:00 Mon-Fri
	Israel	*6557/00972-39142800	08:00-17:00 Sun-Thu
		*9770/00972-35598555	08:30-17:30 Sun-Thu
Balkan Countries	Romania	0040-213301786	09:00-18:30 Mon-Fri
	Bosnia Herzegovina	00387-33773163	09:00-17:00 Mon-Fri
	Bulgaria	00359-70014411	09:30-18:30 Mon-Fri
		00359-29889170	09:30-18:00 Mon-Fri
	Croatia	00385-16401111	09:00-17:00 Mon-Fri
	Montenegro	00382-20608251	09:00-17:00 Mon-Fri
	Serbia	00381-112070677	09:00-17:00 Mon-Fri
	Slovenia	00368-59045400	08:00-16:00 Mon-Fri
		00368-59045401	
	Estonia	00372-6671796	09:00-18:00 Mon-Fri
Latvia	00371-67408838	09:00-18:00 Mon-Fri	
Lithuania-Kaunas	00370-37329000	09:00-18:00 Mon-Fri	
Lithuania-Vilnius	00370-522101160	09:00-18:00 Mon-Fri	

NOTE: For more information, visit the ASUS support site at: <http://support.asus.com>