

4 5 M E T R I C T O N



JOHN DEERE

D

EXCAVATOR

450D LC

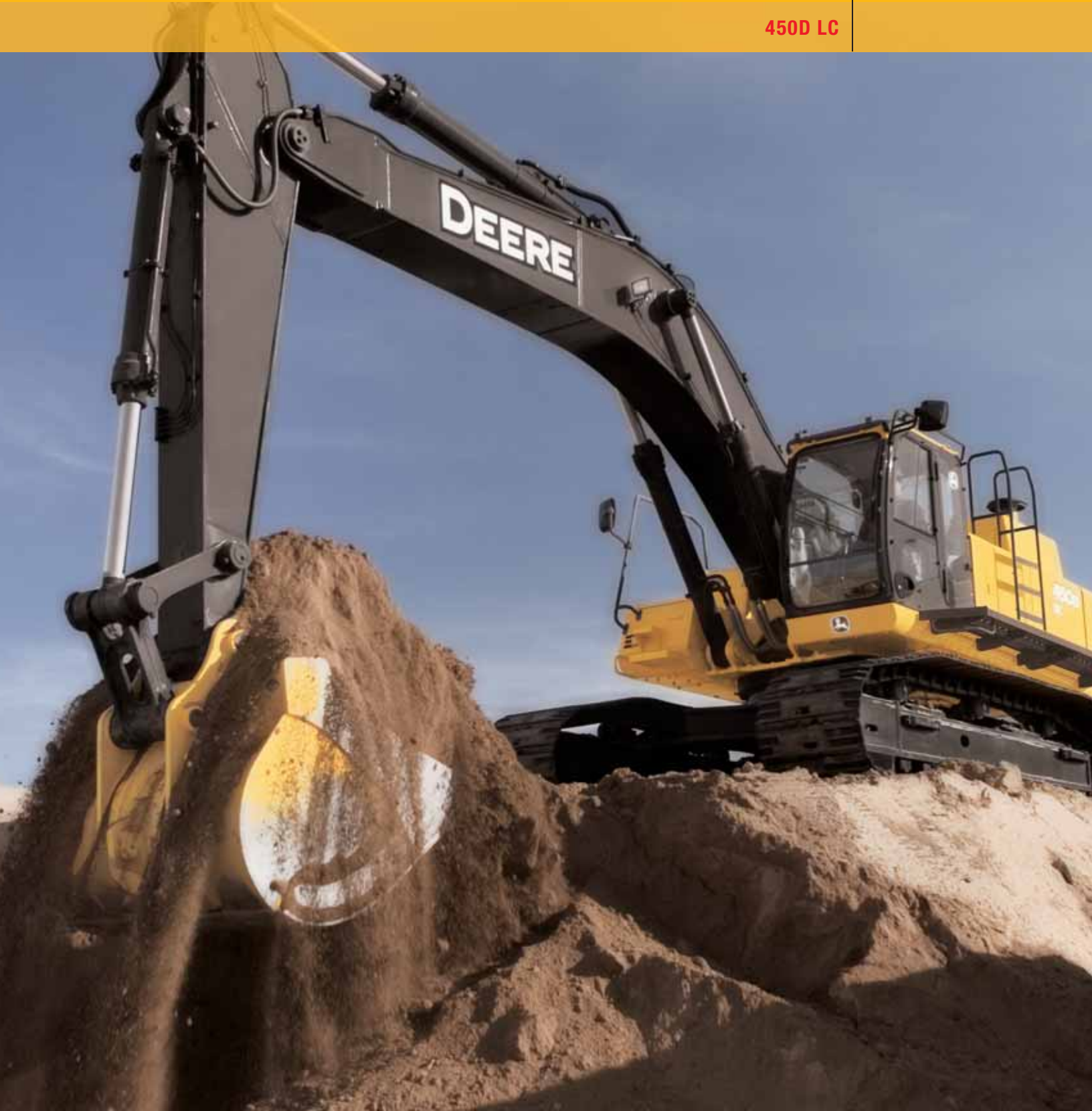



DEERE

One of a kind.

Often imitated but never duplicated, the John Deere 450D LC once again sets the standard for power, smoothness, ease of operation, and comfort. Like its predecessor, the highly popular and productive 450C LC, the D-Series boasts more of everything. A larger, slower-running engine and even

more efficient cooling system for long-lasting durability. Quieter, more spacious, and comfortable cab with even better visibility. And more operating weight, arm force, and lift capacity. Read on to learn more about how the 450D LC is well-armed to deliver maximum productivity and uptime.



Extended engine and hydraulic fluid service intervals simplify maintenance and reduce daily operating costs.

Redesigned cab combines more legroom and 47-percent more glass for unsurpassed comfort and visibility.

Powerwise™ III engine/hydraulic management system maximizes power output, saves fuel, and delivers smooth multifunction hydraulic operation.

Hydraulically driven fan runs only as needed, reducing noise, fuel consumption, and operating costs.

Fuel-efficient Tier III emission-certified 15.7-L diesel delivers power without compromise in all conditions.

Specifications

450D LC

SAE Net Horsepower	348 hp
Operating Weight	106,180 lb.
Lift Capacity	29,900 lb.
Digging Depth	27 ft. 2 in.
Arm Breakout Force	43,028 lb.

Variable-speed fan, noise-reducing muffler, and isochronous high-idle speed help quiet things down.

Machine Information Center (MIC) captures and stores vital machine performance and utilization data to help improve uptime, productivity, and profit.

Choose from a variety of track widths, booms, arms, buckets, and other options.

Additional hydraulic capability a necessity? Dealer-installed high-pressure, high-flow auxiliary hydraulic packages meet the need.



1. Generous hydraulic flow and best-in-class metering ensure powerful digging force and superb multifunction operation. When extra hydraulic muscle is needed, simply press the power-boost button to break through.

2. Powerwise III perfectly balances engine performance and hydraulic flow for smooth finesse and predictable operation. One work mode makes it easy to be productive in any application.

3. With more horsepower, weight, lift capacity, swing torque, arm force, bucket force, and drawbar pull than the model it replaces, you can expect big productivity from the 450D LC.



A large yellow John Deere 450D LC tracked excavator is shown in a desert environment. The excavator is the central focus, with its arm and bucket visible on the left. The body is bright yellow with black tracks. The text '450D LC' and 'DEERE' are clearly visible on the side of the machine. The background is a clear blue sky and sandy ground.

The strong, silent type.

Other excavators may talk the talk, but the 450D LC walks the walk. Combining faster hydraulics with exceptional reach, lift capacity, and arm force, this new Deere provides the muscle and finesse for everything from mass excavation to utility work. Control is smooth and effortless, with the Powerwise III management

system delivering pinpoint metering. And with several new noise-reducing features, the 450D LC quietly goes about its business, with less operator fatigue. Plus numerous options are available, so you can equip the 450D LC exactly the way you need to maximize your efforts.



More room for more productivity.

It's hard not to be productive working from the air-suspension heated seat in this spacious, sound-suppressed operating environment. The well-appointed cab offers more of everything operators need to do their best. Forty-seven-percent more glass for better visibility. Substantially more legroom and generous storage.

More creature comforts, too, including high-velocity automatic climate control, AM/FM radio, 12-volt power port, and hot/cold box for storage, to list just a few. Operators will also appreciate what the 450D LC delivers less of — like reduced noise levels, lower lever efforts, and productivity-robbing fatigue.



Wide expanse of glass, narrower front cab posts, large overhead hatch, and numerous mirrors provide virtually unobstructed all-around visibility.

Ergonomically designed short-throw pilot levers provide smooth, predictable fingertip control with less movement and effort.

Convenient 12-volt port powers cell phones and other electronic devices.

Redesigned cab isn't just roomier, it's also noticeably quieter and more comfortable. Silicone-filled mounts effectively isolate operators from noise and vibration.

Automatic, high-velocity bi-level climate-control system with automotive-style adjustable louvers helps keep the glass clear and the cab comfortable.

1. Multi-position air-suspension seat has 10½ inches of travel, sliding together or independently of the control console. So it won't cramp an operator's style.
2. No shortage of storage in here. There's a place for a cooler, cup holders, and even a hot/cold beverage box that keeps drinks at just the right temperature.
3. Intuitive, multi-language monitor provides a wealth of machine info and control. Its LCD four-color screen displays operating, diagnostic, and maintenance info with easy-on-the-eyes clarity.



Three welded bulkheads in the heavy-duty boom resist torsional stress. Rigid, reinforced D-channel side frames resist impacts, providing maximum cab and component protection.

Highly efficient, heavy-duty cooling system keeps things cool. Reversing fan back-blows cooler cores to reduce debris buildup. It's a welcome addition that will increase uptime.

Perforated screens behind the side shields serve as a "first filter," helping prevent trash entry. Anything that passes through will also clear the cooler cores.

Large box-section track frames, thick-plate single-sheet mainframe, and massive swing bearing deliver rock-solid durability.

Boom, arm, and mainframe are so tough, they're warranted for three years or 10,000 hours.



1

1. Heavy-duty, slow-running sleeved diesel delivers long-term engine durability.



2

2. Compare the size of the 450D LC's carrier and bottom rollers, idlers, and sealed and lubricated chain. This is one heavy-duty undercarriage.

3. Hydraulically driven fan runs only as needed, reducing fuel consumption and debris flow through the coolers.

4. State-of-the-art multifunction diagnostic monitor helps troubleshoot problems and defeat downtime.

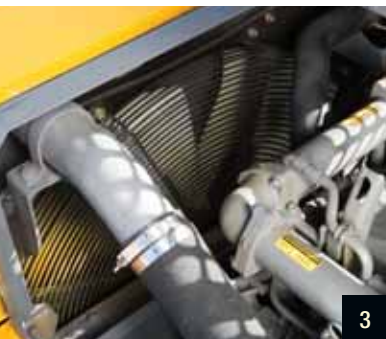

3



4

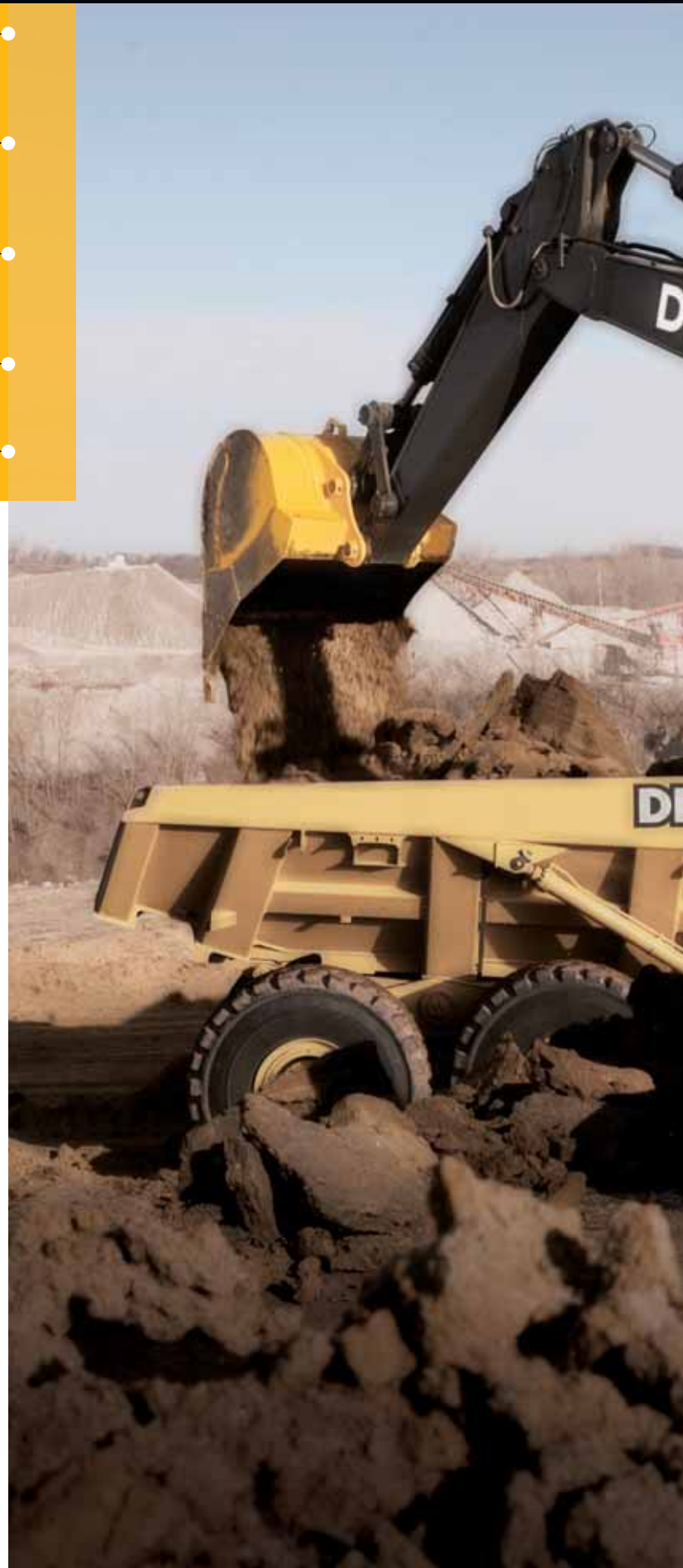



Nothing runs like a Deere because nothing is built like one.

Uptime makes the difference between a job well done and a job gone wrong. That's why the 450D LC is built tough for maximum reliability — from its rugged D-channel main-frame to its heavy-duty fuel-sipping diesel. The significantly beefed-up undercarriage

delivers long and reliable performance. Other durability-boosting features such as a sleeved engine, heavy-duty boom, and extended engine and hydraulic oil change intervals help keep downtime to a minimum. When you know how they're built, you'll run a Deere.

Machine Information Center, remote diagnostics, and fluid-sample ports help speed preventative maintenance and troubleshooting.

Auto-idle reduces engine speed when hydraulics aren't in use, helping make the most of every precious drop of fuel.

Larger fuel tank and 500- and 5,000-hour engine and hydraulic oil service intervals enable the 450D LC to work longer between stops for service.

Conveniently located sight gauges let you check coolant and hydraulic fluid levels at a glance.

Wide, slip-resistant "Deere walk," sturdy handrails, and self-cleaning steps provide convenient one-side access to the engine service area.

Nobody backs you better than the 500-plus John Deere dealers throughout North America.



Minimize maintenance, maximize results.

Increasing uptime and lowering daily operating costs shouldn't be a reach — and it's not with the 450D LC. Wide, slip-resistant steps and large, easy-to-open service doors provide easy access to conveniently grouped service points and major components. Remote-mounted oil and fuel filters

and extended engine and hydraulic oil service intervals minimize periodic maintenance. Plus a Machine Information Center, diagnostic monitor, and available fluid-sample ports help you make timely decisions about machine upkeep — and improve uptime, productivity, and profit.

1. Easy-to-navigate monitor enables you to reference maintenance intervals and check engine oil and coolant levels at the touch of a button.

4. Easy-to-open hinged doors provide quick access to service items. Filters and check points are grouped for added convenience.

2. Vertical spin-on engine, hydraulic, and fuel filters simplify service and help minimize messes.

5. Fresh-air cab filter is quickly serviced from outside the cab where it's more likely to get done.

3. Wide fin spacing lets trash easily pass through cores to resist plugging. Hinged swing-out coolers allow additional access to the cores for easier cleanout, if necessary.

6. Centralized lube banks place difficult-to-lube zerks within easy reach. Prominently posted lube chart helps ensure that nothing gets overlooked.



Specifications

450D
LC

Engine

450D LC

Type	Isuzu AH-6WG1XYSA-01 with turbocharger and air-to-air charge air cooler; meets EPA and CARB emission non-road regulations
Rated Power	348 SAE net hp (260 kW) @ 1,800 rpm
Cylinders	6
Displacement	957 cu. in. (15.681 L)
Maximum Net Torque	1,164 lb.-ft. (1580 Nm) @ 1,500 rpm
Cooling Fan	suction-type, hydraulic-driven, remote-mounted drive
Electrical System	24 volt with 50-amp alternator
Batteries (two 12 volt)	reserve capacity: 280 min.
Off-level capacity	70% (35 deg.)

Hydraulic System

Main Pumps	two variable-displacement axial-piston
Maximum Flow	2 x 100 gpm (2 x 379 L/min.)
Pilot Pump	one gear
Maximum Flow	7.9 gpm (30 L/min.)
Pressure Setting	566 psi (3900 kPa)
System Operating Pressure	
Implement Circuits	4,625 psi (31 900 kPa)
Travel Circuits	4,980 psi (34 300 kPa)
Swing Circuits	4,045 psi (27 900 kPa)
Power Boost	4,980 psi (34 300 kPa)
Oil Filtration	one 10-micron full-flow return filter with by-pass / one pilot oil filter

Cylinders

	Bore	Rod Diameter	Stroke
Boom (2)	6.7 in. (170 mm)	4.5 in. (115 mm)	62.6 in. (1590 mm)
Arm (1)	7.5 in. (190 mm)	5.1 in. (130 mm)	76.4 in. (1940 mm)
Bucket (1)	6.7 in. (170 mm)	4.7 in. (120 mm)	52.2 in. (1325 mm)

Swing Mechanism

Swing Speed	0-9 rpm
Swing Torque	107,004 lb.-ft. (145 189 Nm)

Undercarriage

Carrier Rollers (per side)	3
Track Rollers (per side)	9
Shoes, Triple Semi-Grouser (per side)	53
Track Guides	front and center
Track Adjustment	hydraulic
Travel Speed	
Low	0-2.1 mph (0-3.4 km/h)
High	0-3.4 mph (0-5.5 km/h)
Drawbar Pull	79,590 lb. (36 100 kg)

Ground Pressure Data

Average Ground Pressure	
30-in. (750 mm) Triple Semi-Grouser Shoes (recommended for rocky terrain/stumps)	8.81 psi (60.7 kPa)
36-in. (900 mm) Triple Semi-Grouser Shoes (recommended for general/soft terrain)	7.45 psi (51.4 kPa)

Capacities (U.S.)

450D LC

Fuel Tank	192 gal. (725 L)
Cooling System	50.7 qt. (48 L)
Engine Lubrication, Including Filter	59 qt. (55.8 L)
Hydraulic Tank	85 gal. (322 L)
Hydraulic System	148 gal. (560 L)
Propel Gearbox (each)	9 qt. (8.5 L)
Swing Drive	5 qt. (4.7 L)

SAE Operating Weights

With Full Fuel Tank; 175-lb. (79 kg) Operator; 3.06-cu.-yd. (2.34 m ³), 54-in. (1370 mm), 4,478-lb. (2031 kg) Bucket; 12-ft. 10-in. (3.9 m) Arm; 20,172-lb. (9150 kg) Counter- weight; and 36-in. (900 mm) Triple Semi- Grouser Shoes	106,180 lb. (48 163 kg)
--	-------------------------

Component Weights

Undercarriage	
30-in. (750 mm) Triple Semi-Grouser Shoes	40,227 lb. (18 247 kg)
36-in. (900 mm) Triple Semi-Grouser Shoes	41,726 lb. (18 927 kg)
One-Piece Boom (with arm cylinder)	9,458 lb. (4290 kg)
Arm with Bucket Cylinder and Linkage	
9 ft. 6 in. (2.9 m)	5,291 lb. (2400 kg)
With 20-ft. 7-in. (6.3 m) Mass-Excavat- ing Boom	5,291 lb. (2400 kg)
11 ft. 2 in. (3.4 m)	5,137 lb. (2330 kg)
12 ft. 10 in. (3.9 m)	5,820 lb. (2640 kg)
16 ft. 1 in. (4.9 m)	4,078 lb. (1850 kg)
Boom Lift Cylinders (2) Total Weight	
3.06-cu.-yd. (2.34 m ³), 54-in. (1370 mm)	1,851 lb. (840 kg)
General-Purpose Bucket	4,478 lb. (2031 kg)
Counterweight	20,172 lb. (9150 kg)

Operating Information

	<i>Arm Length 9 ft. 6 in. (2.9 m)</i>	<i>20-ft. 7-in. (6.3 m) Mass-Excavat- ing Boom w/9-ft. 6-in. (2.9 m) Arm</i>	<i>Arm Length 11 ft. 2 in. (3.4 m)</i>	<i>Arm Length 12 ft. 10 in. (3.9 m)</i>	<i>Arm Length 16 ft. 1 in. (4.9 m)</i>
Arm Force with 36-in. (900 mm) Triple Semi-Grouser Shoes*	51,014 lb. (227 kN)	51,014 lb. (227 kN)	47,321 lb. (210 kN)	43,028 lb. (192 kN)	37,560 lb. (167 kN)
Bucket Digging Force with 36-in. (900 mm) Triple Semi-Grouser Shoes*	57,111 lb. (254 kN)	57,111 lb. (254 kN)	57,111 lb. (254 kN)	57,111 lb. (254 kN)	43,624 lb. (194 kN)
Lifting Capacity Over Front @ Ground Level					
20-ft. (6.1 m) Reach*	40,000 lb. (18 144 kg)	39,900 lb. (18 099 kg)	40,200 lb. (18 235 kg)	39,200 lb. (17 781 kg)	38,600 lb. (17 509 kg)
A Maximum Reach	37 ft. 5 in. (11.40 m)	35 ft. 8 in. (10.86 m)	39 ft. 7 in. (12.06 m)	41 ft. 0 in. (12.49 m)	43 ft. 9 in. (13.34 m)
A' Maximum Reach @ Ground Level	36 ft. 8 in. (11.17 m)	34 ft. 10 in. (10.61 m)	38 ft. 10 in. (11.84 m)	40 ft. 3 in. (12.28 m)	43 ft. 1 in. (13.14 m)
B Maximum Digging Depth	23 ft. 11 in. (7.28 m)	20 ft. 5 in. (6.23 m)	25 ft. 6 in. (7.77 m)	27 ft. 2 in. (8.27 m)	29 ft. 11 in. (9.11 m)
B' Maximum Digging Depth @ 8-ft. (2.44 m) Flat Bottom	23 ft. 3 in. (7.08 m)	19 ft. 11 in. (6.08 m)	25 ft. 0 in. (7.63 m)	26 ft. 8 in. (8.14 m)	29 ft. 6 in. (9.00 m)
C Maximum Cutting Height	33 ft. 8 in. (10.25 m)	35 ft. 8 in. (10.88 m)	36 ft. 3 in. (11.06 m)	36 ft. 7 in. (11.16 m)	38 ft. 6 in. (11.73 m)
D Maximum Dumping Height	23 ft. 1 in. (7.03 m)	24 ft. 1 in. (7.33 m)	25 ft. 1 in. (7.65 m)	25 ft. 6 in. (7.77 m)	28 ft. 5 in. (8.67 m)
E Minimum Swing Radius	16 ft. 6 in. (5.02 m)	12 ft. 11 in. (3.93 m)	15 ft. 10 in. (4.84 m)	15 ft. 9 in. (4.81 m)	15 ft. 11 in. (4.85 m)
F Maximum Vertical Wall	17 ft. 3 in. (5.27 m)	16 ft. 6 in. (5.02 m)	21 ft. 7 in. (6.59 m)	22 ft. 11 in. (6.98 m)	27 ft. 7 in. (8.42 m)
G Tail Swing Radius	12 ft. 0 in. (3.65 m)	12 ft. 0 in. (3.65 m)	12 ft. 0 in. (3.65 m)	12 ft. 0 in. (3.65 m)	12 ft. 0 in. (3.65 m)

*Digging forces and lift capacities with power boost.

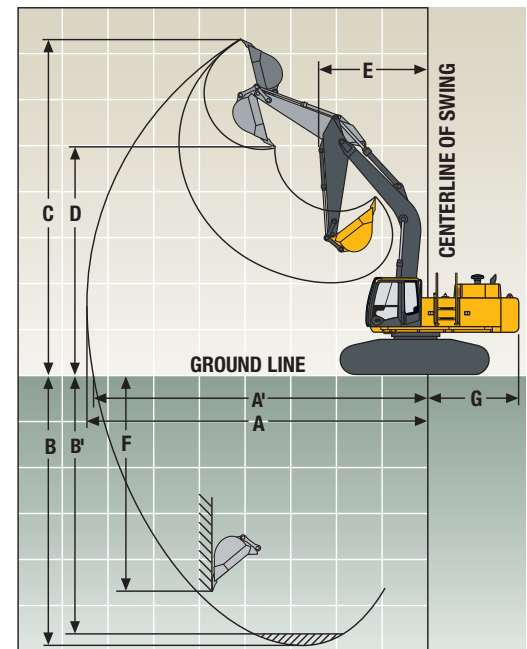

Dimensions

450D LC

- A** 9-ft. 6-in. (2.9 m) Arm 11 ft. 10 in. (3.60 m)
 11-ft. 2-in. (3.4 m) Arm 11 ft. 5 in. (3.48 m)
 12-ft. 10-in. (3.9 m) Arm 11 ft. 6 in. (3.50 m)
 16-ft. 1-in. (4.9 m) Arm 14 ft. 11 in. (4.55 m)
 20-ft. 7-in. (6.3 m) ME Boom with 9-ft. 6-in.
 (2.9 m) Arm 12 ft. 3 in. (3.74 m)
- B** 9-ft. 6-in. (2.9 m) Arm 39 ft. 4 in. (12.0 m)
 11-ft. 2-in. (3.4 m) Arm 39 ft. 1 in. (11.91 m)
 12-ft. 10-in. (3.9 m) Arm 39 ft. 1 in. (11.91 m)
 16-ft. 1-in. (4.9 m) Arm 39 ft. 0 in. (11.9 m)
 20-ft. 7-in. (6.3 m) ME Boom with 9-ft. 6-in.
 (2.9 m) Arm 36 ft. 10 in. (11.22 m)
- C** Operating Position 9 ft. 6 in. (2.89 m)
 Transport Position 7 ft. 10 in. (2.39 m)
- D** 30-in. (750 mm) Triple Semi-Grouser Shoes
 Operating Position 11 ft. 11 in. (3.64 m)
 Transport Position 10 ft. 4 in. (3.14 m)
 36-in. (900 mm) Triple Semi-Grouser Shoes
 Operating Position 12 ft. 5 in. (3.79 m)
 Transport Position 10 ft. 10 in. (3.29 m)

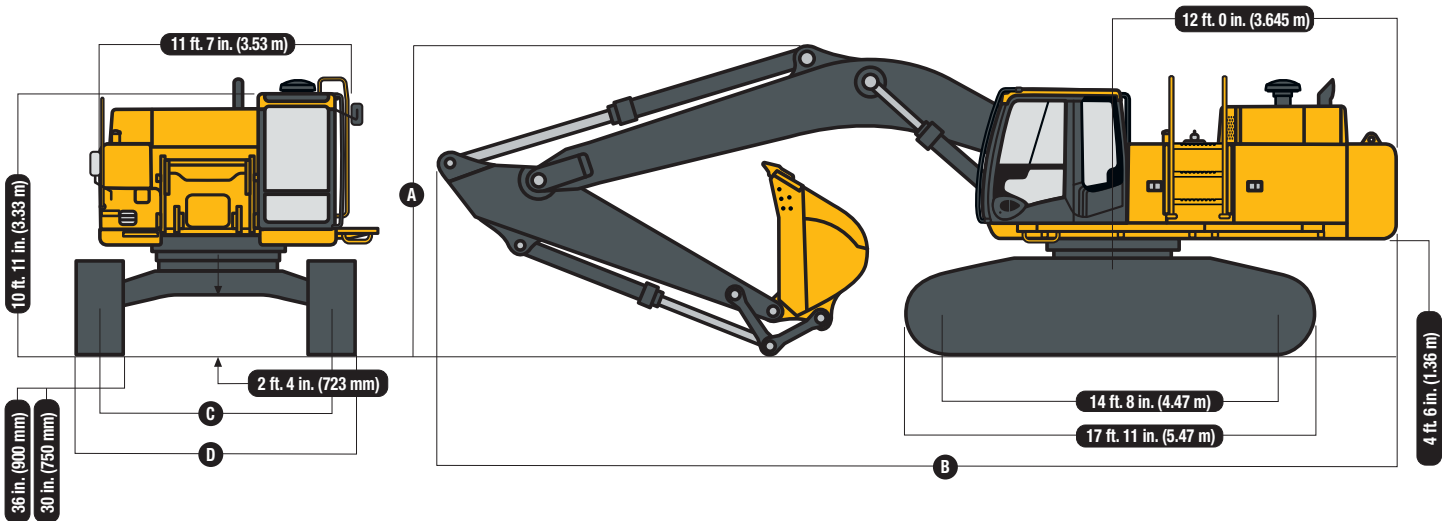

Lift Capacities

Boldface italic type indicates hydraulic-limited capacities; lightface type indicates stability-limited capacities, in lb. (kg). Ratings at bucket lift hook; machine equipped with 20,172-lb. (9150 kg) counterweight; standard gauge; and situated on firm, uniform supporting surface. Total load includes weight of cables, hook, etc. Figures do not exceed 87 percent of hydraulic capacities or 75 percent of weight needed to tip machine. All lift capacities are based on SAE J1097.

Load Point Height	10 ft. (3.05 m)		15 ft. (4.57 m)		20 ft. (6.10 m)		25 ft. (7.62 m)		30 ft. (9.15 m)	
	Over Front	Over Side	Over Front	Over Side	Over Front	Over Side	Over Front	Over Side	Over Front	Over Side
<i>With 23-ft. 0-in. (7.0 m) boom; 9-ft. 6-in. (2.9 m) arm; 3.0-cu.-yd. (2.3 m³), 3,924-lb. (1780 kg) bucket; and 30-in. (750 mm) triple semi-grouser shoes</i>										
25 ft. (7.62 m)							21,500 (9752)	21,500 (9752)		
20 ft. (6.10 m)							22,600 (10 251)	21,700 (9843)		
15 ft. (4.57 m)			39,900 (18 099)	39,900 (18 099)	29,600 (13 426)	29,600 (13 426)	24,700 (11 204)	20,800 (9435)	22,000 (9979)	15,000 (6804)
10 ft. (3.05 m)					34,800 (15 785)	28,000 (12 701)	27,300 (12 383)	19,800 (8981)	22,100 (10 024)	14,500 (6577)
5 ft. (1.52 m)					38,700 (17 554)	26,300 (11 930)	29,500 (13 381)	18,800 (8528)	23,800 (10 796)	14,000 (6350)
Ground Line					40,000 (18 144)	25,500 (11 567)	30,800 (13 971)	18,200 (8255)	23,300 (10 569)	13,600 (6169)
-5 ft. (-1.52 m)			49,400 (22 408)	40,500 (18 371)	39,000 (17 690)	25,200 (11 431)	30,500 (13 835)	17,900 (8119)	23,100 (10 478)	13,400 (6078)
-10 ft. (-3.05 m)	47,900 (21 727)	47,900 (21 727)	44,300 (20 094)	41,000 (18 597)	35,900 (16 284)	25,400 (11 521)	28,300 (12 837)	17,900 (8119)		
-15 ft. (-4.57 m)			36,500 (16 556)	36,500 (16 556)	29,900 (13 563)	26,000 (11 794)	22,600 (10 251)	18,400 (8346)		

Lift Capacities (continued)

450D LC

Boldface italic type indicates hydraulic-limited capacities; **lightface** type indicates stability-limited capacities, in lb. (kg). Ratings at bucket lift hook; machine equipped with 20,172-lb. (9150 kg) counterweight; standard gauge; and situated on firm, uniform supporting surface. Total load includes weight of cables, hook, etc. Figures do not exceed 87 percent of hydraulic capacities or 75 percent of weight needed to tip machine. All lift capacities are based on SAE J1097.

Load Point Height	10 ft. (3.05 m)		15 ft. (4.57 m)		20 ft. (6.10 m)		25 ft. (7.62 m)		30 ft. (9.15 m)	
	Over Front	Over Side	Over Front	Over Side	Over Front	Over Side	Over Front	Over Side	Over Front	Over Side
<i>With 23-ft. 0-in. (7.0 m) boom; 11-ft. 2-in. (3.4 m) arm; 2.7-cu.-yd. (2.1 m³), 3,593-lb. (1630 kg) bucket; and 30-in. (750 mm) triple semi-grouser shoes</i>										
20 ft. (6.10 m)							21,500 (9752)	21,500 (9752)	18,500 (8392)	15,900 (7212)
15 ft. (4.57 m)					28,000 (12 701)	28,000 (12 701)	23,700 (10 750)	21,400 (9707)	21,300 (9662)	15,500 (7031)
10 ft. (3.05 m)					33,400 (15 150)	29,000 (13 154)	26,500 (12 020)	20,400 (9253)	22,700 (10 297)	15,000 (6804)
5 ft. (1.52 m)					37,900 (17 191)	27,200 (12 338)	29,200 (13 245)	19,400 (8800)	24,100 (10 932)	14,400 (6532)
Ground Line			25,400 (11 521)	25,400 (11 521)	40,200 (18 235)	26,100 (11 839)	30,800 (13 971)	18,600 (8437)	23,700 (10 750)	14,000 (6350)
-5 ft. (-1.52 m)			43,200 (19 595)	40,700 (18 461)	40,100 (18 189)	25,600 (11 612)	31,100 (14 107)	18,200 (8255)	23,400 (10 614)	13,700 (6214)
-10 ft. (-3.05 m)	38,800 (17 600)	38,800 (17 600)	48,200 (21 863)	41,100 (18 643)	37,700 (17 101)	25,600 (11 612)	29,600 (13 426)	18,100 (8210)	23,100 (10 478)	13,700 (6214)
-15 ft. (-4.57 m)	49,300 (22 362)	49,300 (22 362)	41,100 (18 643)	41,100 (18 643)	32,800 (14 878)	26,100 (11 839)	25,500 (11 567)	18,500 (8392)		
-20 ft. (-6.10 m)			29,600 (13 426)	29,600 (13 426)	23,400 (10 614)	23,400 (10 614)				
<i>With 23-ft. 0-in. (7.0 m) boom; 12-ft. 10-in. (3.9 m) arm; 2.5-cu.-yd. (1.9 m³), 5,434-lb. (1570 kg) bucket; and 30-in. (750 mm) triple semi-grouser shoes</i>										
25 ft. (7.62 m)									11,200 (5080)	11,200 (5080)
20 ft. (6.10 m)									17,900 (8119)	16,000 (7258)
15 ft. (4.57 m)							22,100 (10 024)	21,600 (9798)	20,000 (9072)	15,600 (7076)
10 ft. (3.05 m)			43,900 (19 913)	43,900 (19 913)	31,100 (14 107)	29,300 (13 290)	25,000 (11 340)	20,400 (9253)	21,500 (9752)	14,900 (6759)
5 ft. (1.52 m)			35,100 (15 921)	35,100 (15 921)	36,100 (16 375)	27,300 (12 383)	27,900 (12 655)	19,300 (8754)	23,100 (10 478)	14,300 (6486)
Ground Line			32,500 (14 742)	32,500 (14 742)	39,200 (17 781)	25,900 (11 748)	29,900 (13 563)	18,400 (8346)	23,500 (10 660)	13,700 (6214)
-5 ft. (-1.52 m)	19,400 (8800)	19,400 (8800)	44,000 (19 958)	40,000 (18 144)	39,800 (18 053)	25,200 (11 431)	30,700 (13 925)	17,900 (8119)	23,100 (10 478)	13,400 (6078)
-10 ft. (-3.05 m)	36,700 (16 647)	36,700 (16 647)	50,200 (22 770)	40,200 (18 235)	38,300 (17 373)	25,100 (11 385)	29,800 (13 517)	17,700 (8029)	23,000 (10 433)	13,300 (6033)
-15 ft. (-4.57 m)	56,100 (25 447)	56,100 (25 447)	43,900 (19 913)	40,800 (18 507)	34,300 (15 558)	25,400 (11 521)	26,800 (12 156)	17,900 (8119)		
-20 ft. (-6.10 m)			33,900 (15 377)	33,900 (15 377)	26,800 (12 156)	26,200 (11 884)	19,200 (8709)	18,700 (8482)		
<i>With 23-ft. 0-in. (7.0 m) boom; 16-ft. 1-in. (4.9 m) arm; 1.8-cu.-yd. (1.4 m³), 2,579-lb. (1170 kg) bucket; and 30-in. (750 mm) triple semi-grouser shoes</i>										
15 ft. (4.57 m)									18,800 (8528)	17,300 (7847)
10 ft. (3.05 m)							23,600 (10 705)	22,500 (10 206)	20,900 (9480)	16,700 (7575)
5 ft. (1.52 m)			48,100 (21 818)	46,000 (20 865)	34,000 (15 422)	29,800 (13 517)	27,000 (12 247)	21,200 (9616)	22,900 (10 387)	15,900 (7212)
Ground Line			42,900 (19 459)	42,900 (19 459)	38,600 (17 509)	28,000 (12 701)	29,900 (13 563)	20,100 (9117)	24,700 (11 204)	15,200 (6895)
-5 ft. (-1.52 m)	19,100 (8664)	19,100 (8664)	43,400 (19 686)	41,600 (18 870)	40,900 (18 552)	26,900 (12 202)	31,700 (14 379)	19,400 (8800)	24,500 (11 113)	14,700 (6668)
-10 ft. (-3.05 m)	30,000 (13 608)	30,000 (13 608)	53,900 (24 449)	41,200 (18 688)	41,100 (18 643)	26,400 (11 975)	32,000 (14 515)	18,900 (8573)	24,100 (10 932)	14,500 (6577)
-15 ft. (-4.57 m)	43,500 (19 731)	43,500 (19 731)	51,200 (23 224)	41,500 (18 824)	38,900 (17 645)	26,300 (11 930)	30,600 (13 880)	18,900 (8573)	24,100 (10 932)	14,400 (6532)
-20 ft. (-6.10 m)	58,800 (26 672)	58,800 (26 672)	44,000 (19 958)	42,200 (19 142)	34,100 (15 468)	26,700 (12 111)	26,600 (12 066)	19,200 (8709)	19,500 (8845)	14,800 (6713)
-25 ft. (-7.62 m)			31,900 (14 470)	31,900 (14 470)	24,700 (11 204)	24,700 (11 204)				
<i>With 20-ft. 8-in. (6.3 m) ME boom; 9-ft. 6-in. (2.9 m) ME arm; 3.3-cu.-yd. (2.5 m³), 4,123-lb. (1870 kg) bucket; and 30-in. (750 mm) triple semi-grouser shoes</i>										
20 ft. (6.10 m)					25,400 (11 521)	25,400 (11 521)	22,500 (10 206)	21,400 (9707)		
15 ft. (4.57 m)			36,200 (16 420)	36,200 (16 420)	28,900 (13 109)	28,900 (13 109)	25,100 (11 385)	20,800 (9435)		
10 ft. (3.05 m)					33,700 (15 286)	28,800 (13 064)	27,300 (12 383)	19,900 (9027)	17,700 (8029)	14,300 (6486)
5 ft. (1.52 m)					37,900 (17 191)	27,000 (12 247)	29,500 (13 381)	19,000 (8618)	22,700 (10 297)	13,900 (6305)
Ground Line			55,100 (24 993)	40,700 (18 461)	39,900 (18 099)	25,900 (11 748)	30,700 (13 925)	18,300 (8301)	20,000 (9072)	13,600 (6169)
-5 ft. (-1.52 m)			51,800 (23 496)	40,600 (18 416)	39,200 (17 781)	25,400 (11 521)	30,200 (13 699)	18,000 (8165)		
-10 ft. (-3.05 m)			45,600 (20 684)	41,100 (18 643)	35,400 (16 057)	25,600 (11 612)	26,800 (12 156)	18,100 (8210)		
-15 ft. (-4.57 m)			35,000 (15 876)	35,000 (15 876)	27,000 (12 247)	26,400 (11 975)				
<i>With 23-ft. 0-in. (7.0 m) boom; 9-ft. 6-in. (2.9 m) arm; 3.0-cu.-yd. (2.3 m³), 3,924-lb. (1780 kg) bucket; and 36-in. (900 mm) triple semi-grouser shoes</i>										
25 ft. (7.62 m)							21,500 (9752)	21,500 (9752)		
20 ft. (6.10 m)							22,600 (10 251)	21,900 (9934)		
15 ft. (4.57 m)			39,900 (18 099)	39,900 (18 099)	29,600 (13 426)	29,600 (13 426)	24,700 (11 204)	21,100 (9571)	22,000 (9979)	15,300 (6940)
10 ft. (3.05 m)					34,800 (15 785)	28,400 (12 882)	27,300 (12 383)	20,000 (9072)	23,100 (10 478)	14,700 (6668)
5 ft. (1.52 m)					38,700 (17 554)	26,700 (12 111)	29,500 (13 381)	19,100 (8664)	24,100 (10 932)	14,200 (6441)
Ground Line					40,000 (18 144)	25,900 (11 748)	30,800 (13 971)	18,400 (8346)	23,700 (10 750)	13,800 (6260)
-5 ft. (-1.52 m)			49,400 (22 408)	41,100 (18 643)	39,000 (17 690)	25,600 (11 612)	30,500 (13 835)	18,100 (8210)	23,500 (10 660)	13,700 (6214)
-10 ft. (-3.05 m)	47,900 (21 727)	47,900 (21 727)	44,300 (20 094)	41,500 (18 824)	35,900 (16 284)	25,800 (11 703)	28,300 (12 837)	18,200 (8255)		
-15 ft. (-4.57 m)			36,500 (16 556)	36,500 (16 556)	29,900 (13 563)	26,400 (11 975)	22,600 (10 251)	18,700 (8482)		

Lift Capacities (continued)

450D LC

Boldface italic type indicates hydraulic-limited capacities; lightface type indicates stability-limited capacities, in lb. (kg). Ratings at bucket lift hook; machine equipped with 20,172-lb. (9150 kg) counterweight; standard gauge; and situated on firm, uniform supporting surface. Total load includes weight of cables, hook, etc. Figures do not exceed 87 percent of hydraulic capacities or 75 percent of weight needed to tip machine. All lift capacities are based on SAE J1097.

Load Point Height	10 ft. (3.05 m)		15 ft. (4.57 m)		20 ft. (6.10 m)		25 ft. (7.62 m)		30 ft. (9.15 m)	
	Over Front	Over Side	Over Front	Over Side	Over Front	Over Side	Over Front	Over Side	Over Front	Over Side
<i>With 23-ft. 0-in. (7.0 m) boom; 11-ft. 2-in. (3.4 m) arm; 2.7-cu.-yd. (2.1 m³), 3,593-lb. (1630 kg) bucket; and 36-in. (900 mm) triple semi-grouser shoes</i>										
20 ft. (6.10 m)							21,500 (9752)	21,500 (9752)	18,500 (8392)	16,100 (7303)
15 ft. (4.57 m)					28,000 (12 701)	28,000 (12 701)	23,700 (10 750)	21,700 (9843)	21,300 (9662)	15,800 (7167)
10 ft. (3.05 m)					33,400 (15 150)	29,400 (13 336)	26,500 (12 020)	20,700 (9389)	22,700 (10 297)	15,200 (6895)
5 ft. (1.52 m)					37,900 (17 191)	27,600 (12 519)	29,200 (13 245)	19,700 (8936)	24,100 (10 932)	14,700 (6668)
Ground Line			25,400 (11 521)	25,400 (11 521)	40,200 (18 235)	26,500 (12 020)	30,800 (13 971)	18,900 (8573)	24,100 (10 932)	14,200 (6441)
-5 ft. (-1.52 m)			43,200 (19 595)	41,300 (18 734)	40,100 (18 189)	26,000 (11 794)	31,100 (14 107)	18,500 (8392)	23,800 (10 796)	13,900 (6305)
-10 ft. (-3.05 m)	38,800 (17 600)	38,800 (17 600)	48,200 (21 863)	41,600 (18 870)	37,700 (17 101)	26,000 (11 794)	29,600 (13 426)	18,400 (8346)	23,100 (10 478)	14,000 (6350)
-15 ft. (-4.57 m)	49,300 (22 362)	49,300 (22 362)	41,100 (18 643)	41,100 (18 643)	32,800 (14 878)	26,400 (11 975)	25,500 (11 567)	18,700 (8482)		
-20 ft. (-6.10 m)			29,600 (13 426)	29,600 (13 426)	23,400 (10 614)	23,400 (10 614)				
<i>With 23-ft. 0-in. (7.0 m) boom; 12-ft. 10-in. (3.9 m) arm; 2.5-cu.-yd. (1.9 m³), 5,434-lb. (1570 kg) bucket; and 36-in. (900 mm) triple semi-grouser shoes</i>										
25 ft. (7.62 m)									11,200 (5080)	11,200 (5080)
20 ft. (6.10 m)									17,900 (8119)	16,200 (7348)
15 ft. (4.57 m)							22,100 (10 024)	21,900 (9934)	20,000 (9072)	15,800 (7167)
10 ft. (3.05 m)			43,900 (19 913)	43,900 (19 913)	31,100 (14 107)	29,700 (13 472)	25,000 (11 340)	20,700 (9389)	21,500 (9752)	15,200 (6895)
5 ft. (1.52 m)			35,100 (15 921)	35,100 (15 921)	36,100 (16 375)	27,700 (12 565)	27,900 (12 655)	19,600 (8891)	23,100 (10 478)	14,500 (6577)
Ground Line			32,500 (14 742)	32,500 (14 742)	39,200 (17 781)	26,300 (11 930)	29,900 (13 563)	18,700 (8482)	23,900 (10 840)	14,000 (6350)
-5 ft. (-1.52 m)	19,400 (8800)	19,400 (8800)	44,000 (19 958)	40,500 (18 371)	39,800 (18 053)	25,600 (11 612)	30,700 (13 925)	18,200 (8255)	23,500 (10 660)	13,600 (6169)
-10 ft. (-3.05 m)	36,700 (16 647)	36,700 (16 647)	50,200 (22 770)	40,700 (18 461)	38,300 (17 373)	25,500 (11 567)	29,800 (13 517)	18,000 (8165)	23,400 (10 614)	13,500 (6124)
-15 ft. (-4.57 m)	56,100 (25 447)	56,100 (25 447)	43,900 (19 913)	41,400 (18 779)	34,300 (15 558)	25,800 (11 703)	26,800 (12 156)	18,200 (8255)		
-20 ft. (-6.10 m)			33,900 (15 377)	33,900 (15 377)	26,800 (12 156)	26,500 (12 020)	19,200 (8709)	18,900 (8573)		
<i>With 23-ft. 0-in. (7.0 m) boom; 16-ft. 1-in. (4.9 m) arm; 1.8-cu.-yd. (1.4 m³), 2,579-lb. (1170 kg) bucket; and 36-in. (900 mm) triple semi-grouser shoes</i>										
15 ft. (4.57 m)									18,800 (8528)	17,600 (7983)
10 ft. (3.05 m)							23,600 (10 705)	22,700 (10 297)	20,900 (9480)	16,900 (7666)
5 ft. (1.52 m)			48,100 (21 818)	46,600 (21 138)	34,000 (15 422)	30,100 (13 653)	27,000 (12 247)	21,500 (9752)	22,900 (10 387)	16,100 (7303)
Ground Line			42,900 (19 459)	42,900 (19 459)	38,600 (17 509)	28,400 (12 882)	29,900 (13 563)	20,400 (9253)	24,700 (11 204)	15,500 (7031)
-5 ft. (-1.52 m)	19,100 (8664)	19,100 (8664)	43,400 (19 686)	42,200 (19 142)	40,900 (18 552)	27,200 (12 338)	31,700 (14 379)	19,600 (8891)	24,800 (11 249)	15,000 (6804)
-10 ft. (-3.05 m)	30,000 (13 608)	30,000 (13 608)	53,900 (24 449)	41,800 (18 960)	41,100 (18 643)	26,700 (12 111)	32,000 (14 515)	19,200 (8709)	24,500 (11 113)	14,700 (6668)
-15 ft. (-4.57 m)	43,500 (19 731)	43,500 (19 731)	51,200 (23 224)	42,000 (19 051)	38,900 (17 645)	26,700 (12 111)	30,600 (13 880)	19,100 (8664)	24,300 (11 022)	14,700 (6668)
-20 ft. (-6.10 m)	58,800 (26 672)	58,800 (26 672)	44,000 (19 958)	42,800 (19 414)	34,100 (15 468)	27,100 (12 292)	26,600 (12 066)	19,400 (8800)	19,500 (8845)	15,100 (6849)
-25 ft. (-7.62 m)			31,900 (14 470)	31,900 (14 470)	24,700 (11 204)	24,700 (11 204)				
<i>With 20-ft. 8-in. (6.3 m) ME boom; 9-ft. 6-in. (2.9 m) ME arm; 3.3-cu.-yd. (2.5 m³), 4,123-lb. (1870 kg) bucket; and 36-in. (900 mm) triple semi-grouser shoes</i>										
20 ft. (6.10 m)					25,400 (11 521)	25,400 (11 521)	22,500 (10 206)	21,700 (9843)		
15 ft. (4.57 m)			36,200 (16 420)	36,200 (16 420)	28,900 (13 109)	28,900 (13 109)	25,100 (11 385)	21,100 (9571)		
10 ft. (3.05 m)					33,700 (15 286)	29,100 (13 200)	27,300 (12 383)	20,200 (9163)	17,700 (8029)	14,600 (6623)
5 ft. (1.52 m)					37,900 (17 191)	27,400 (12 429)	29,500 (13 381)	19,200 (8709)	22,700 (10 297)	14,100 (6396)
Ground Line			55,100 (24 993)	41,200 (18 688)	39,900 (18 099)	26,200 (11 884)	30,700 (13 925)	18,600 (8437)	20,000 (9072)	13,800 (6260)
-5 ft. (-1.52 m)			51,800 (23 496)	41,200 (18 688)	39,200 (17 781)	25,800 (11 703)	30,200 (13 699)	18,200 (8255)		
-10 ft. (-3.05 m)			45,600 (20 684)	41,700 (18 915)	35,400 (16 057)	26,000 (11 794)	26,800 (12 156)	18,400 (8346)		
-15 ft. (-4.57 m)			35,000 (15 876)	35,000 (15 876)	27,000 (12 247)	26,700 (12 111)				

Buckets

450D LC

A full line of buckets is offered to meet a wide variety of applications. Digging forces are with power boost. Tooth selection includes either the John Deere Fanggs®, Standard, Tiger, Twin Tiger, Abrasion panel, or Flare tooth, or the ESCO (Vertalok) Standard, Tiger, Twin Tiger, or Flare tooth. Replaceable cutting edges are available through John Deere parts. Optional side cutters add 6 inches (150 mm) to bucket widths.

Type Bucket	Bucket Width		Bucket Capacity*		Weight		Bucket Dig Force		Arm Dig Force 9 ft. 6 in. (2.9 m)		Arm Dig Force 11 ft. 2 in. (3.4 m)		Arm Dig Force 12 ft. 10 in. (3.9 m)		Arm Dig Force 16 ft. 1 in. (4.9 m)		Bucket Tip Radius		No. Teeth
	in.	mm	cu. yd.	m³	lb.	kg	lb.	kN	lb.	kN	lb.	kN	lb.	kN	lb.	kN	in.	mm	
General-Purpose Plate Lip	54	1370	2.30	1.76	2,215	1005	40,505	180.2							34,778	155.0	69.5	1765	7
Heavy-Duty Plate Lip	42	1065	1.85	1.41	3,124	1417	54,900	244.0	51,705	230.0	44,354	197.0	40,474	180.0			71.5	1816	5
	48	1220	2.15	1.64	3,320	1505	54,900	244.0	51,705	230.0	44,354	197.0	40,474	180.0			71.5	1816	6
	54	1370	2.45	1.87	3,578	1623	54,900	244.0	51,705	230.0	44,354	197.0	40,474	180.0			71.5	1816	6
	60	1525	2.74	2.10	3,771	1710	54,900	244.0	51,705	230.0	44,354	197.0	40,474	180.0			71.5	1816	7
	66	1675	3.01	2.30	3,825	1735	54,900	244.0	51,705	230.0	44,354	197.0	40,474	180.0			71.5	1816	7
	72	1830	3.29	2.52	4,061	1842	54,900	244.0	51,705	230.0	44,354	197.0	40,474	180.0			71.5	1816	8
Truck Loading	72	1830	4.18	3.20	4,340	2041	53,028	236.0	51,013	227.0	43,816	195.0	40,026	178.0			74.0	1880	6
Heavy-Duty High Capacity	48	1220	2.69	2.06	3,969	1800	53,028	236.0	51,013	227.0	43,816	195.0	40,026	178.0			74.0	1880	5
	54	1370	3.06	2.34	4,478	2031	53,028	236.0	51,013	227.0	43,816	195.0	40,026	178.0			74.0	1880	5
	60	1525	3.43	2.62	5,131	2327	53,028	236.0	51,013	227.0	43,816	195.0	40,026	178.0			74.0	1880	6
	66	1675	3.80	2.91	5,003	2269	53,028	236.0	51,013	227.0	43,816	195.0	40,026	178.0			74.0	1880	6
	72	1830	4.18	3.20	5,865	2660	53,028	236.0	51,013	227.0	43,816	195.0	40,026	178.0			74.0	1880	7

*All capacities are SAE heaped ratings and with side cutters.

Bucket Selection Guide*

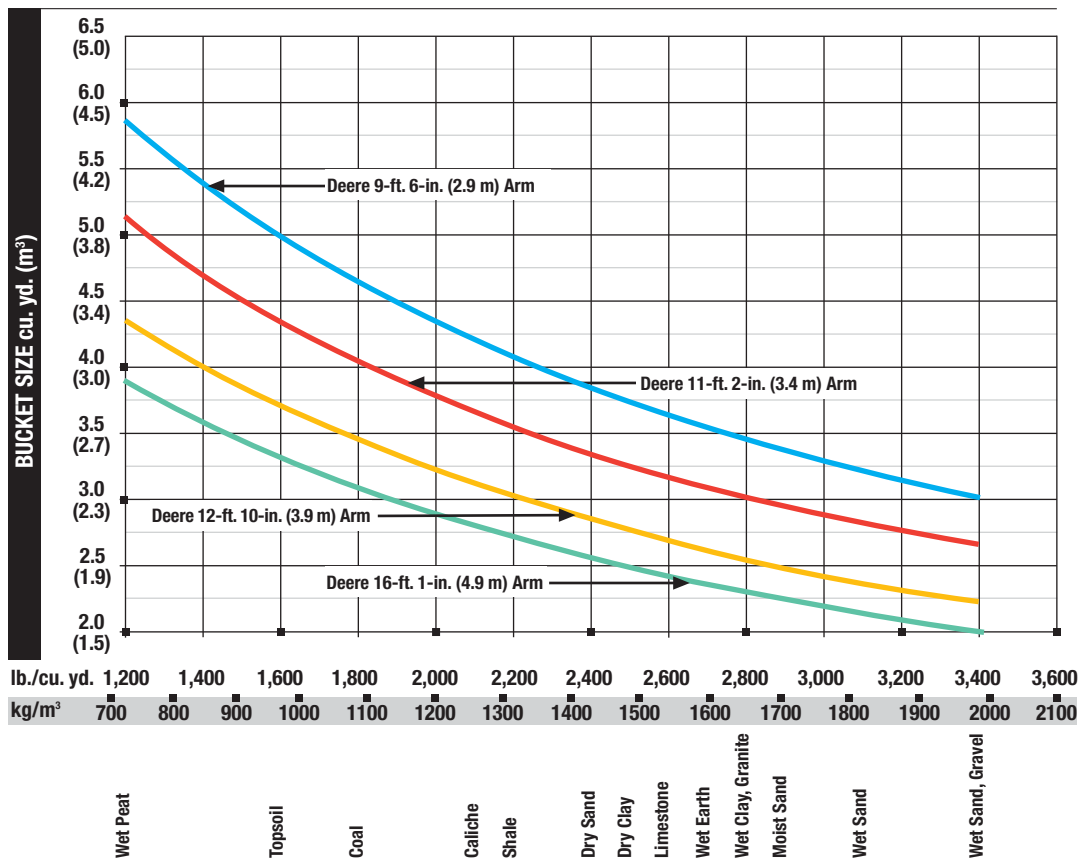

*Contact your John Deere dealer for optimum bucket and attachment selections. These recommendations are for general conditions and average use. Does not include optional equipment such as thumbs or couplers. Larger buckets may be possible when using light materials, for flat and level operations, less compacted materials, and volume loading applications such as mass excavation applications in ideal conditions. Smaller buckets are recommended for adverse conditions such as off-level applications, rocks, and uneven surfaces. Bucket capacity indicated is SAE heaped.

450D LC EXCAVATOR

Key: ● Standard equipment ▲ Optional or special equipment

*See your John Deere dealer for further information.

450D Engine

- Meets EPA and CARB emission non-road regulations
- Auto-idle system
- Batteries (two 12 volt), 280-min. reserve capacity
- Coolant recovery tank
- Dual-element dry-type air filter
- Electronic engine control
- Enclosed fan guard (conforms to SAE J1308)
- Engine coolant to -34°F (-37°C)
- Fuel filter with water separator
- Full-flow oil filter
- Turbocharger with charge air cooler
- Muffler, under hood, with vertical curved end exhaust stack
- Cool-on-demand hydraulic-driven fan
- Glow-plug start aid
- 500-hour engine-oil-change interval
- 70% (35 deg.) off-level capability
- ▲ Engine-oil-sampling valve
- Hydraulic fan reverser

Hydraulic System

- Reduced-drift valve for boom down, arm in
- Auxiliary hydraulic valve section
- Spring-applied, hydraulically released automatic swing brake
- Auxiliary hydraulic-flow adjustments through monitor
- Auto power lift
- 5,000-hour hydraulic-oil-change interval
- ▲ Hydraulic-oil-sampling valve
- ▲ Auxiliary hydraulic lines
- ▲ Auxiliary pilot and electric controls
- ▲ Hydraulic filter restriction indicator kit
- ▲ Load-lowering control device
- ▲ Single-pedal propel control
- ▲ Pattern changer

Undercarriage

- Planetary drive with axial piston motors
- Propel motor shields
- Spring-applied, hydraulically released automatic propel brake
- Track guides, front idler and center
- Two-speed propel with automatic shift
- Upper carrier rollers (3)
- Sealed and lubricated track chain
- ▲ Triple semi-grouser shoes, 30 in. (750 mm)
- ▲ Triple semi-grouser shoes, 36 in. (900 mm)

450D Upperstructure

- ▲ Counterweight-removal system
- Right- and left-hand mirrors
- Vandal locks with ignition key: Cab door / Fuel cap / Service doors / Toolbox
- Debris-screening side panel
- Service platform, left side
- Remote-mounted engine oil and fuel filters

Front Attachments

- Centralized lubrication system
- Dirt seals on all bucket pins
- No-boom-arm option
- ▲ Boom, 23 ft. 0 in. (7.0 m)
- ▲ Boom, mass excavating, 20 ft. 8 in. (6.3 m)
- ▲ Arm, mass excavating, 9 ft. 6 in. (2.9 m)
- ▲ Arm, 9 ft. 6 in. (2.9 m)
- ▲ Arm, 11 ft. 2 in. (3.4 m)
- ▲ Arm, 12 ft. 10 in. (3.9 m)
- ▲ Arm, 16 ft. 1 in. (4.9 m)
- ▲ Attachment quick-couplers
- ▲ Boom cylinder with plumbing to mainframe for no-boom-arm option
- ▲ Buckets: Heavy duty / Heavy-duty high capacity / Side cutters and teeth
- ▲ Material clamps
- ▲ Super-long fronts

Operator's Station

- Adjustable independent control positions (levers-to-seat, seat-to-pedals)
- AM/FM radio
- Auto climate control/air conditioner, 20,000 Btu/hr. (5.9 kW) with heater and pressurizer
- Built-in Operator's Manual storage compartment and manual
- Cell-phone power outlet, 12 volt, 60 watt, 5 amp
- Coat hook
- Deluxe air-suspension heated cloth seat with 4-in. (100 mm) adjustable armrests
- Floor mat
- Front windshield wiper with intermittent speeds
- Gauges (illuminated): Engine coolant / Fuel
- Horn, electric
- Hourmeter, electric
- Hydraulic shutoff lever, all controls
- Hydraulic warm-up control

450D Operator's Station (continued)

- Interior light
- Large cup holder
- Machine Information Center (MIC)
- Mode selectors (illuminated): Power modes – three / Travel modes – two with automatic shift / Work mode – one / Boom mode
- Multifunction, color LCD monitor with: Diagnostic capability / Multiple-language capabilities / Maintenance tracking / Clock / System monitoring with alarm features: Auto-idle, engine air cleaner restriction indicator light, engine check, engine coolant temperature indicator light with audible alarm, engine oil pressure indicator light with audible alarm, low-alternator-charge indicator light, low-fuel indicator light, fault code alert indicator, fuel-rate display, wiper-mode indicator, work-lights-on indicator, and work-mode indicator
- Fluid-level switch and indicator light for engine coolant and engine oil
- ▲ Monitor system with alarm features: Hydraulic oil filter restriction indicator light
- Motion alarm with cancel switch (conforms to SAE J994)
- Power-boost switch on right console lever
- Propel pedals and levers
- SAE two-lever control pattern
- Seat belt, 2 in. (51 mm), retractable
- ▲ Seat belt, 3 in. (76 mm), non-retractable
- Tinted glass
- Transparent tinted overhead hatch
- Hot/cold beverage compartment
- ▲ 24- to 12-volt D.C. radio convertors, 10 amp
- ▲ Circulation fan
- ▲ Protection screens for cab front, rear, and side
- ▲ Window vandal protection covers

Electrical

- 50-amp alternator
- Blade-type multi-fused circuits
- Positive terminal battery covers
- ▲ Cab extension wiring harness
- JDLink™ Ultimate wireless communication system with 3 years of service
- JDLink™ wireless communication system

Lights

- Work lights: Halogen / One mounted on boom / One mounted on frame

CONTROL OWNING AND OPERATING COSTS

Customer Personal Service (CPS) is part of John Deere's proactive, fix-before-fail strategy on machine maintenance that will help control costs, increase profits, and reduce stress. Included in this comprehensive lineup of ongoing programs and services are:

Fluid analysis program – tells you what's going on inside *all* of your machine's major components so you'll know if there's a problem *before* you see a decline in performance. Fluid analysis is included in most extended coverage and preventive-maintenance agreements.

Component life-cycle data – gives you vital information on the projected life span of components and lets you make informed decisions on machine maintenance by telling you approximately how many hours of use you can expect from an engine, transmission, or hydraulic pump. This information can be used to preempt catastrophic downtime by servicing major components at about 80 percent of their life cycle.

Preventive Maintenance (PM) agreements – give you a fixed cost for maintaining a machine for a given period of time. They also help you avoid downtime by ensuring that

critical maintenance work gets done right and on schedule. On-site preventive maintenance service performed where and when you need it helps protect you from the expense of catastrophic failures and lets you avoid waste-disposal hassles.

Extended coverage – gives you a fixed cost for machine repairs for a given period of time so you can effectively manage costs. Whether you work in a severe-service setting or just want to spread the risk of doing business, this is a great way to custom-fit coverage for your operation. And an extended coverage contract also travels well because it's backed by John Deere and is honored by *all* Deere construction dealers.

Customer Support Advisors (CSAs) – Deere believes the CSA program lends a *personal* quality to Customer Personal Service (CPS). Certified CSAs have the knowledge and skills for helping make important decisions on machine maintenance and repair. Their mission is to help you implement a plan that's right for *your* business and take the burden of machine maintenance off your shoulders.



JOHN DEERE

DKAX450DLC Litho in U.S.A. (09-08)

Net engine power is with standard equipment including air cleaner, exhaust system, alternator, and cooling fan, at standard conditions per SAE J1349 and DIN 6270B, using No. 2-D fuel at 35 API gravity. No derating is required up to 10,000-ft. (3050 m) altitude. Gross power is without cooling fan.

Specifications and design subject to change without notice. Wherever applicable, specifications are in accordance with SAE standards. Except where otherwise noted, these specifications are based on a unit with 54-in. (1370 mm) bucket, 36-in. (900 mm) triple semi-grouser shoes, 20,172-lb. (9150 kg) counterweight, full fuel tank, and 175-lb. (79 kg) operator.

