

CÓDIGO	DESCRIÇÃO DAS PEÇAS	QT.	DIMENSÃO = MM
1308	LATERAL DIREITA	01	510X2.080X12
791	LATERAL ESQUERDA	01	510X2.080X12
792	LATERAL DO GAVETEIRO	01	344X510X12
793	PRATELEIRA SUPERIOR	01	445X585X15
1305	LATERAL INTERNA	01	445X1.107X12
1784	BASE SUPERIOR	01	510X1.182X15
1389	BASE INFERIOR	01	510X1.182X15
823	RODAPÉ DIANTEIRO	01	160X1.182X15
824	RODAPÉ TRASEIRO	01	160X1.182X15
1785	PORTA DIREITA	01	606X1.458X15
1786	PORTA ESQUERDA	01	606X1.458X15
1498	FRENTE DE GAVETA	04	174X593X15
1499	LATERAL DIREITA DE GAVETA	04	130X350X12
1500	LATERAL ESQUERDA DE GAVETA	04	130X350X12
1501	FUNDO PARA GAVETA	04	350X548X3
1502	CONTRA-FUNDO	04	120X536X12
825	FUNDO TRASEIRO	03	494X1.200X3
826	FUNDO TRASEIRO INFERIOR	01	360X1.200X3
827	MOLDURA	01	120X1.208X15
1307	BASE INTERNA	01	445X1.182X12
949	BATENTE	01	80X350X12
1464	TRAVAMENTO DO RODAPÉ	01	158X479X15

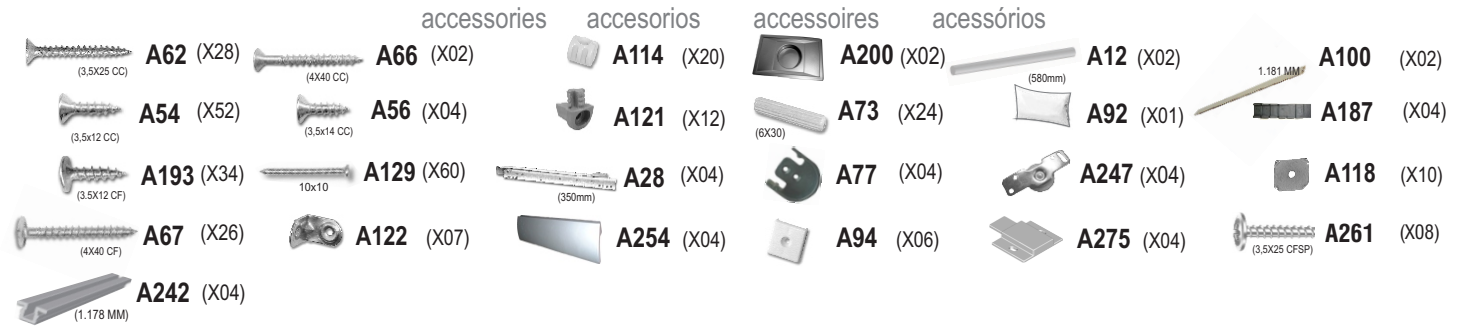

2 - preparation of the pieces / preparación de las piezas / préparation des pièces / preparação das peças

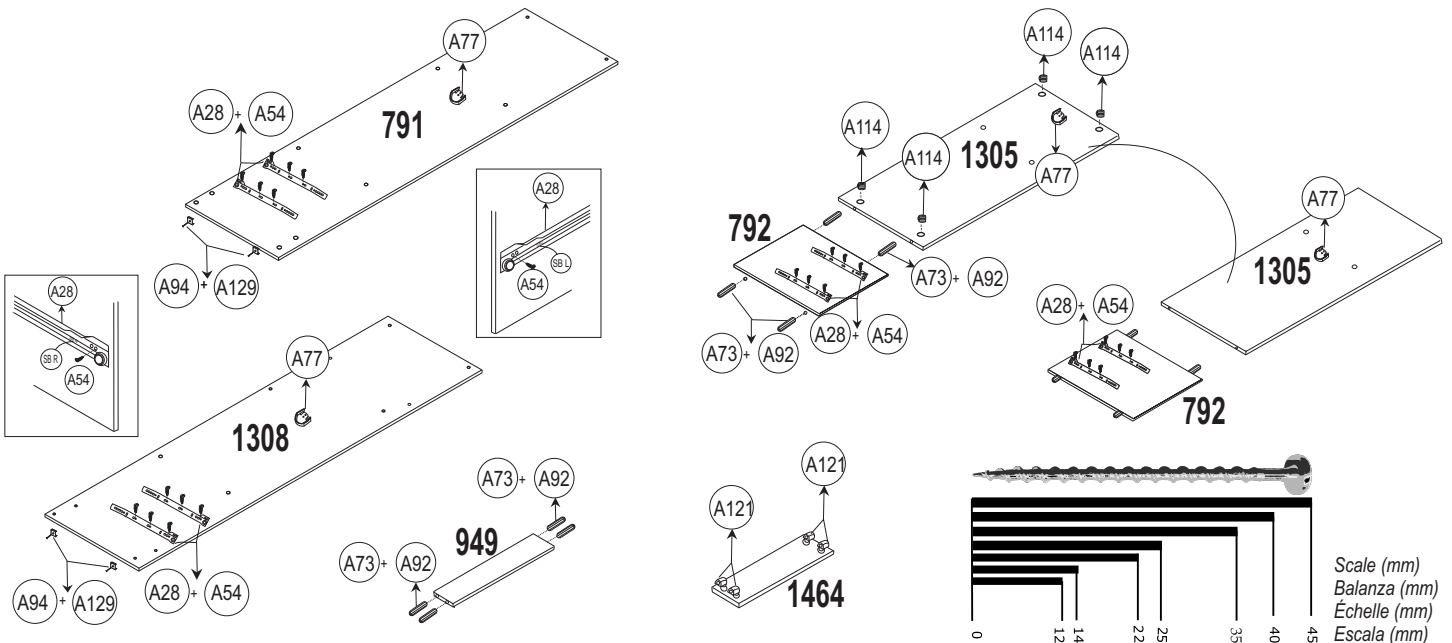

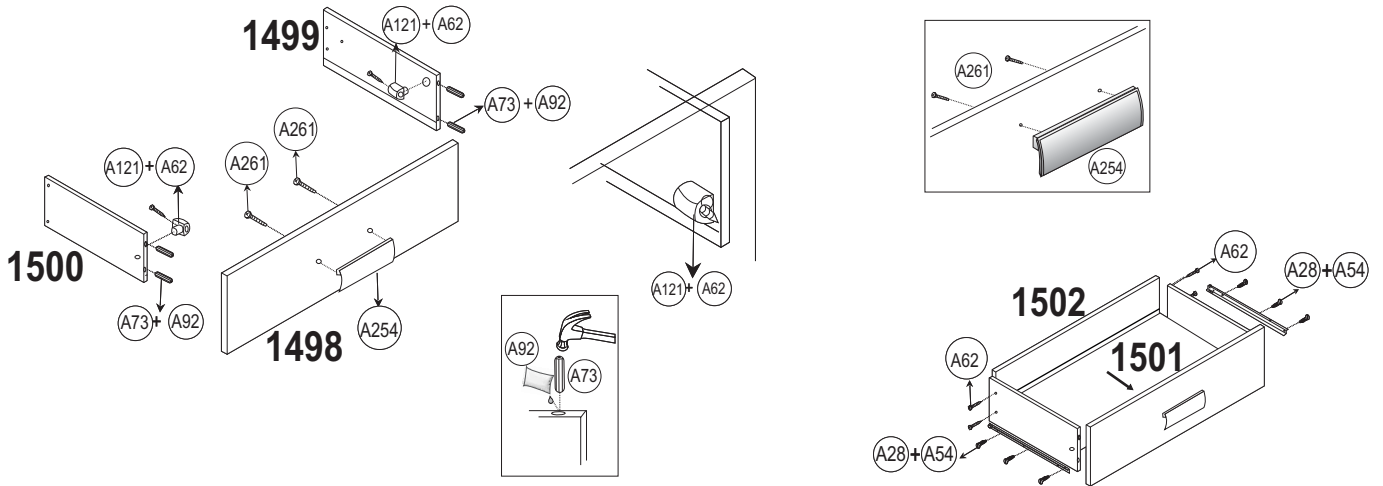
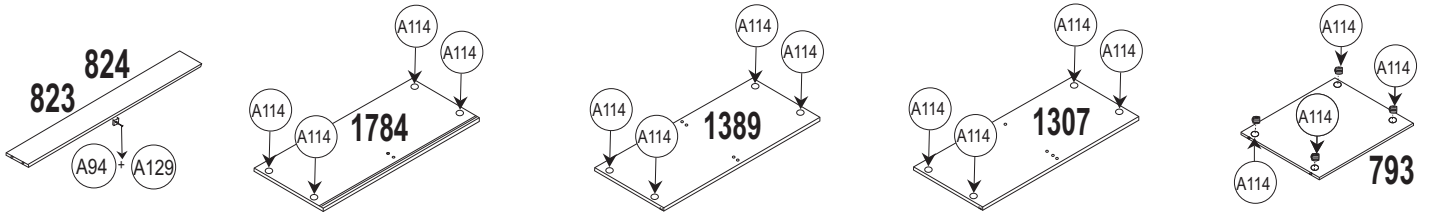

01

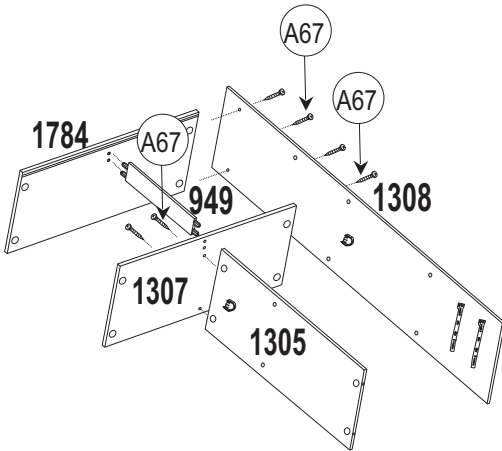

02

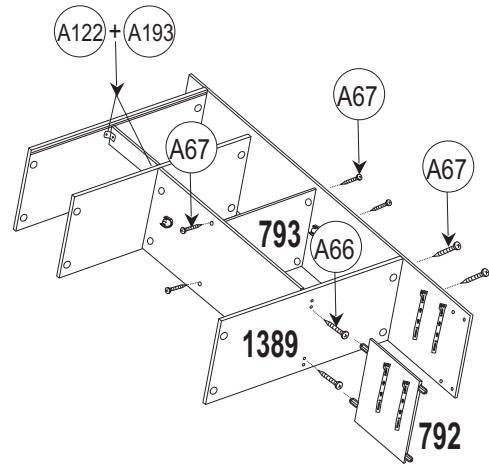

03

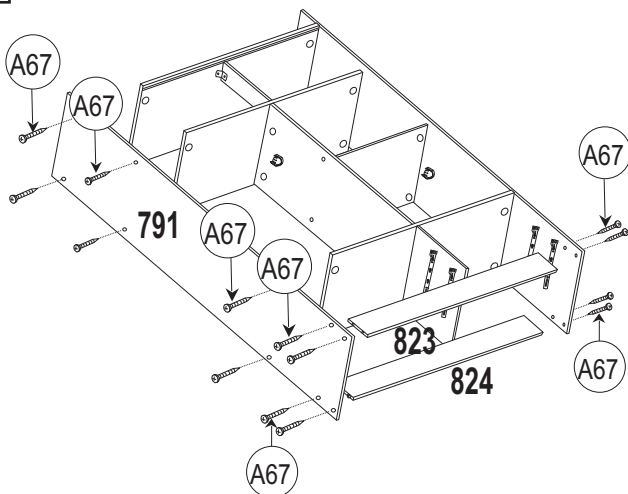

04

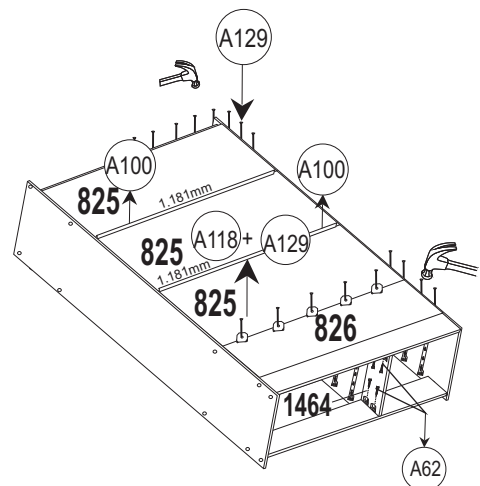

05

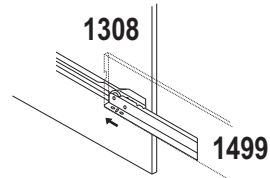
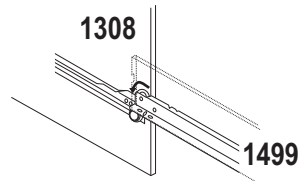
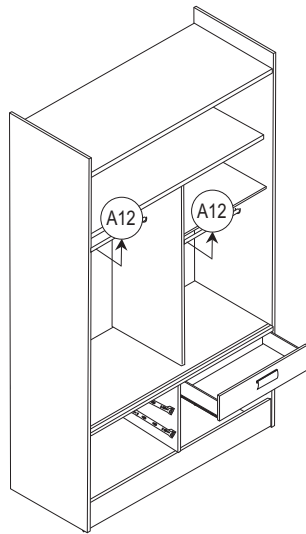

accessories accesorios accessoires acessórios



A247

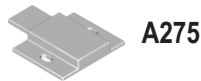

A275



A193

(3.5X12 CF)

06

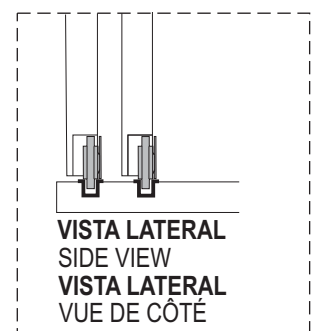
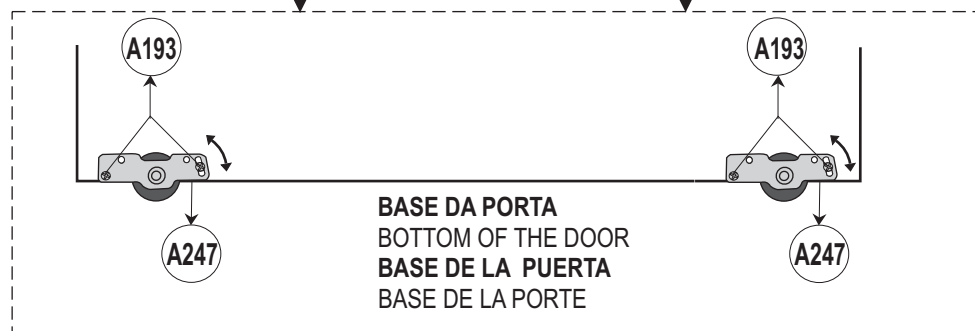
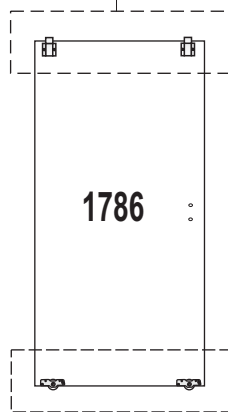
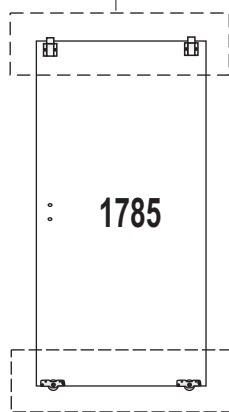
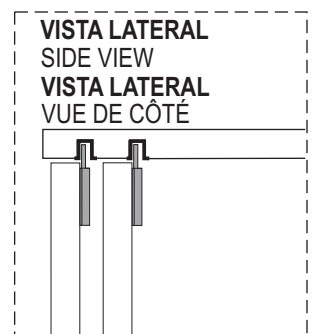
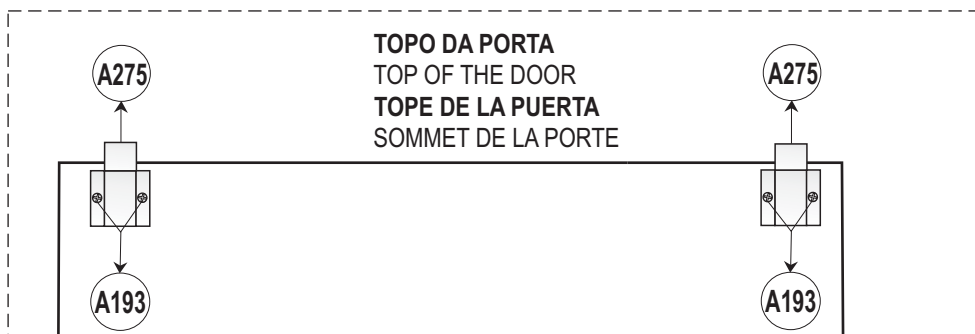

07

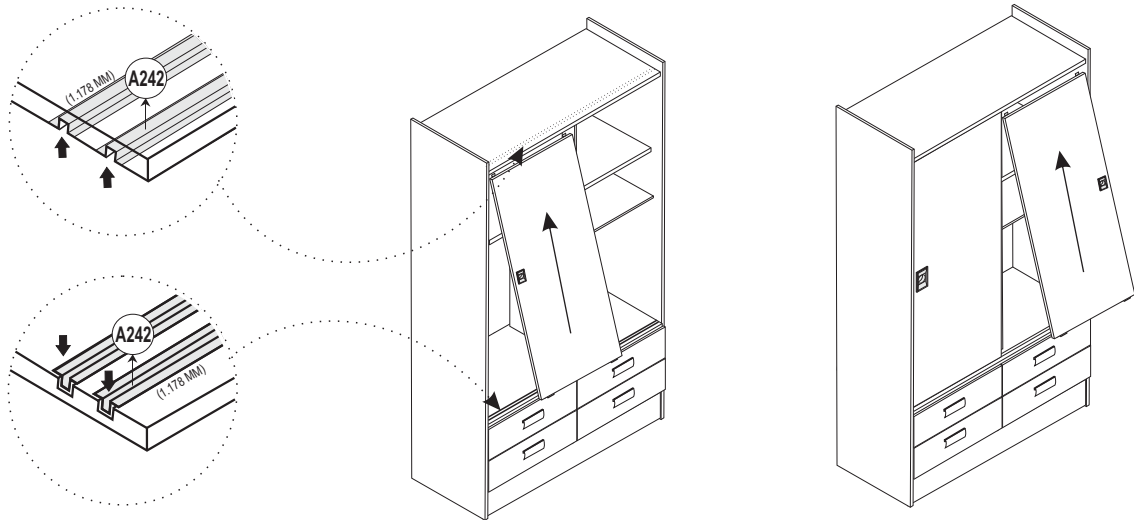

08

- In order to let the doors perfectly leveled, please see the picture and adjust them using screw A193 from A247 hardware.

- Para ajustar correctamente la puerta, por favor observe la imagen. Para que las puertas queden en el mismo nivel el ajuste debe ser hecho por el tornillo A193 del accesorio de A247.
- Pour ajuster correctement la porte, observez s'il vous plaît l'image. Afin que les portes soit au même niveau l'ajustement devrait être fait par la vis A193 de l'accessoire A247.
- Para o ajuste ideal das portas, observe a foto em destaque. Para que as portas fiquem no mesmo nível, o ajuste deverá ser feito através do parafuso A193 do acessório A247.

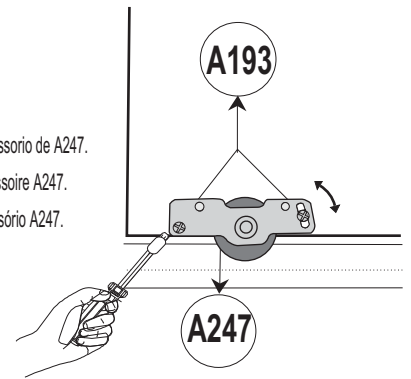

09

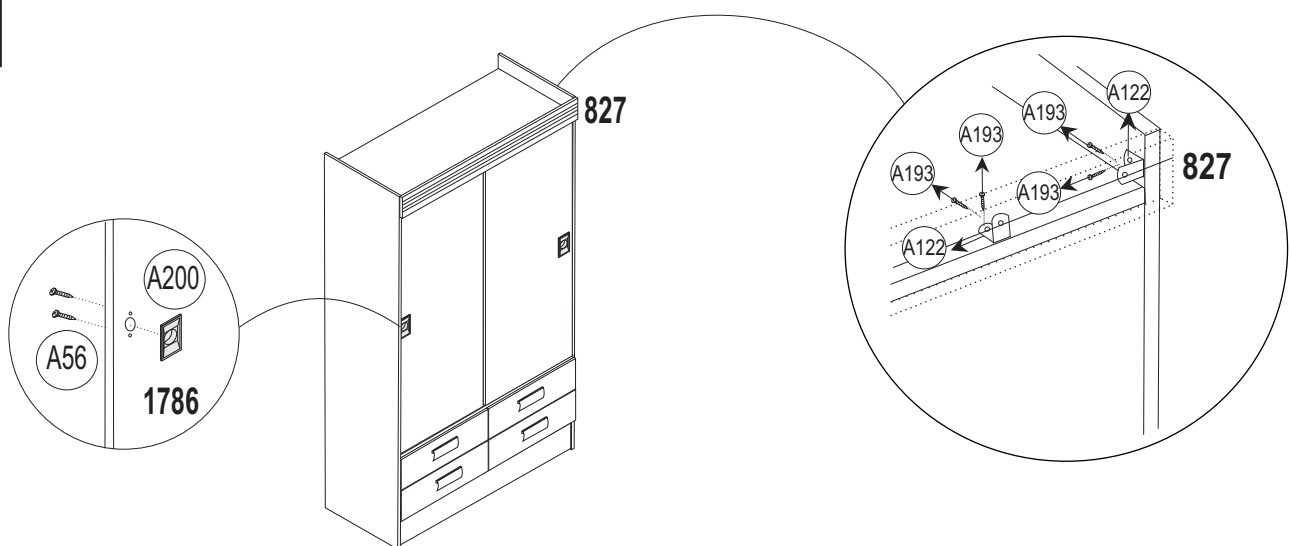

peça piece pièce pieza

• Em caso de problemas técnicos com o móvel, favor informar o número de lote e data de fabricação, identificados nas bordas de alguns componentes dos móveis, para o rastreamento interno do produto e solução do problema.

• If technical problems happened, please find the lot number and manufacturing date, identified on borders of some furniture's pieces, to internal tracking and problem's solution.

• Dans le cas de problèmes technique avec le meuble, informer le numéro de lot et la date de fabrication, identifié dans le cadre de quelque composant des meuble, permettant a nous identifier le produit et le problème.

• En caso de problemas técnicos, por favor informe el N° del lote y la fecha de fabricación identificada en el borde de algunas de las partes del mueble para la identificación interna del producto y la solución del problema.

