

Quick Start Guide



The iEQ45™ GoTo German Equatorial Mount #8000D, #8000DP and #8000AZ



PACKAGE CONTENTS¹

- Telescope Mount (with built-in GPS)
- Losmandy/Vixen dual saddle
- Go2Nova® 8407 Hand Controller
- Two 5 kg Counterweight
- Controller Cable X 2
- LED with cable for Polar Scope
- AC adapter (100V-240V)
- 12V DC adaptor cable with car lighter plug
- RS232 cable
- RS232 to RJ9 cable
- 2-inch Tripod (8000D)
- Pier (8000AZ and 8000DP)
- AZ base (8000AZ)
- Vertical Locking Knob (8000AZ)
- Polar axis cover with spirit level (8000AZ)

ONLINE CONTENTS (click under "Support" menu) www.iOptron.com

- Manuals (*you will need to refer to the full manual for details on set-up and operation*).
- Tips for set up
- Hand controller and mount firmware upgrades (check online for latest version)
- Reviews and feedback from other customers

¹ Actual contents, specifications and color may vary. Please refer to iOptron website for latest information.

Quick Setup

- A. Setup tripod:** Expand the tripod legs and lock the Tripod Spreader so that the tripod legs stay open (Figure 1). Adjust the tripod height by unlocking and re-locking the tripod legs to desired height. Position the tripod so that the Alignment Peg faces north. (*The Alignment Peg may be moved to the opposite position if used at latitude lower than 20° to avoid counterweights hitting the tripod leg*).

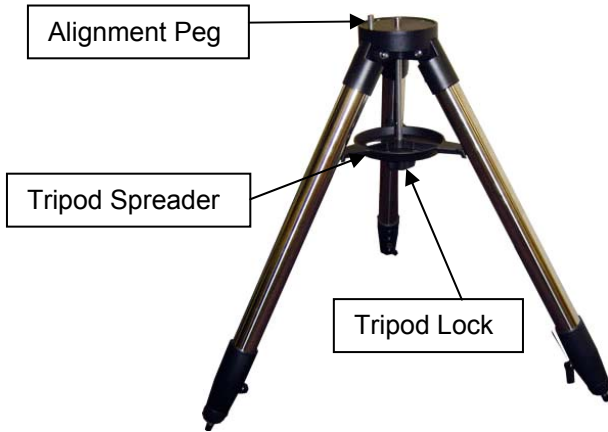

Figure 1

- B. Setup pier:** Unthread the Pier Locking Screw (*This screw is only used for pier storage*). Separate the Pier Base with Legs from the Pier Tube. Remove the Pull Rods from inside the pier.

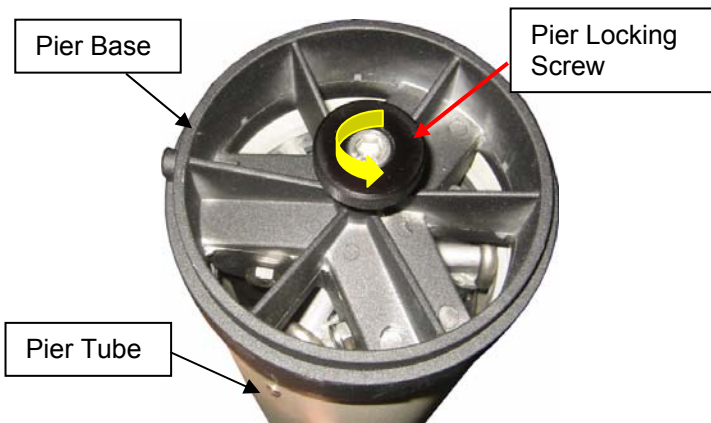

Figure 2

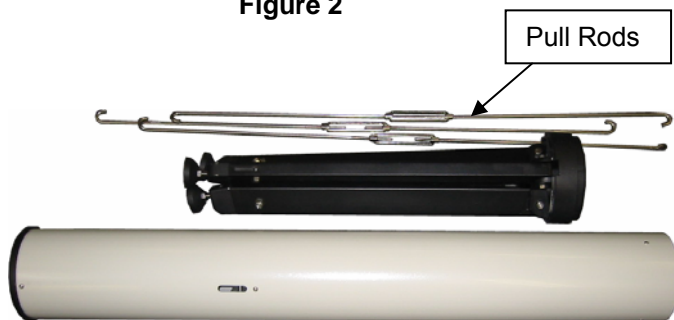

Figure 3

Move the Pier Foot from the end to the side.

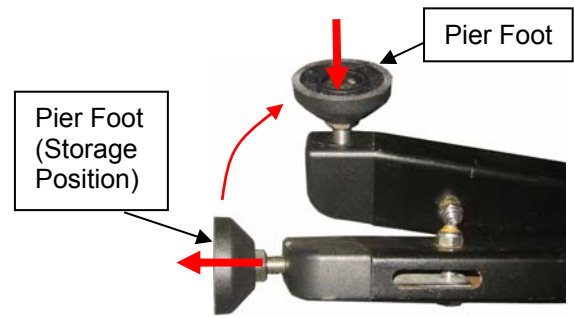

Figure 4

Spread the Pier Leg. Put the Pier Tube onto the Pier Base, with Pier Alignment Slot aligned over the Alignment Tab on the Pier Base.

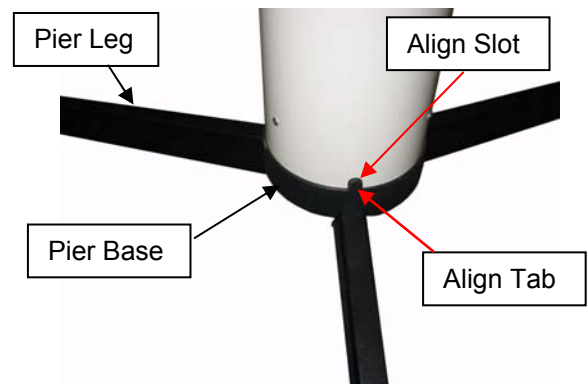

Figure 5

Adjust the length of the three Pull Rods. Hook one end of a Pull Rod onto a bolt located on the Pier Leg and the other Pull Rod end onto the mounting beam inside the Pier Tube. Evenly tighten the Pull Rods. Make sure there is no gap between the Pier Base and Pier Tube.





Figure 6

Position the pier with Alignment Peg face north.

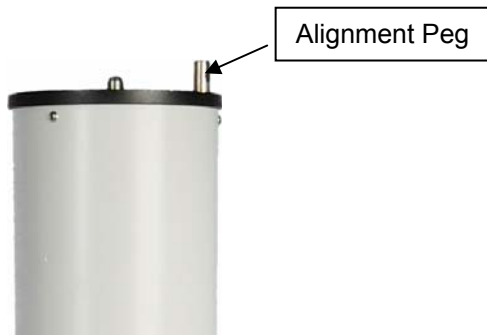

Figure 7

2. **Attach the EQ mount:** Retract the Azimuth Adjustment Knobs (next to the Bubble Level Indicator) to allow enough clearance for the Alignment Peg seating in the house. Put the mount onto the tripod head (or pier top) with bubble level on top of the Alignment Peg (**Figure 9**). Secure the mount head by tightening two Azimuth Locking T-bolts (**Figure 8**). Level the mount by adjusting individual tripod leg (or pier foot). You may use the build-in Bubble Level Indicator or an external torpedo level to check level.

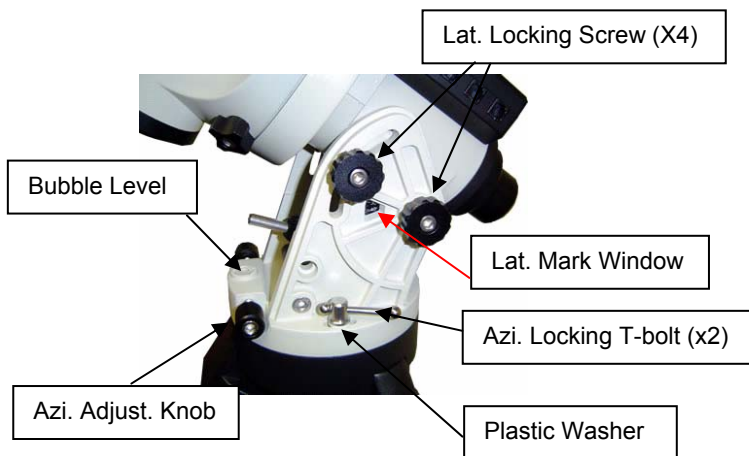

Figure 8

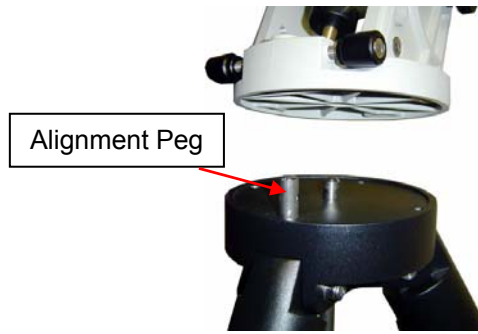

Figure 9

3. **Set the Latitude:** Unlock the four R.A. Clutch Screws and rotate the mount 180° around the R.A. axis (**Figure 10**) to move the dovetail face upside. Tighten the R.A. Clutch Screws. Un-screw the Altitude Adjustment Lever from Altitude Adjustment Knob (**Figure 11**). Turn the Latitude Adjustment Knob to set your current Latitude, which is displayed in Latitude Mark Window. Use the Lever for fine adjustments as needed. Always set the latitude without the load.

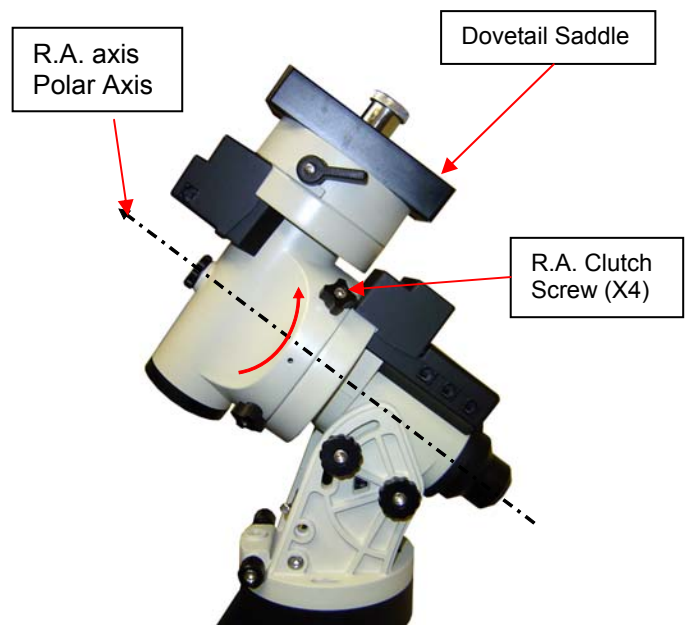

Figure 10

If your latitude is between 5° to 40°, set the Latitude Adjustment Knob to the lower position. A Latitude Safety Block has to be installed (**Figure 11**)

If your latitude is between 35° to 70°, take the Latitude Safety Block off. Set the Latitude Adjustment Knob to the upper position. You should change the position before attaching the mount to the tripod head.

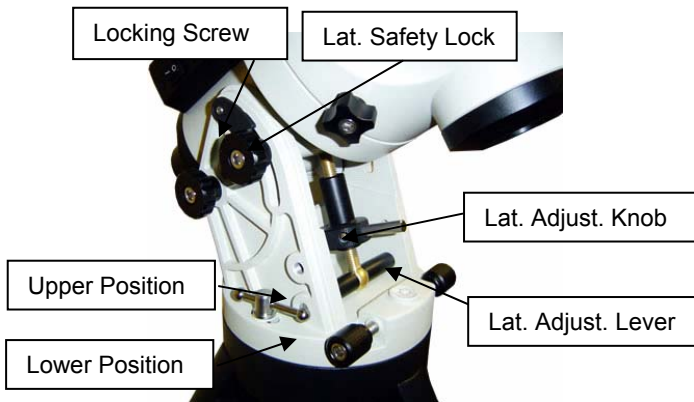

Figure 11

4. **Attach counterweight (CW) shaft:** Unscrew the CW shaft from the top of the mount (Figure 12 top) and thread it into the opening of the DEC axis (Figure 12 bottom).

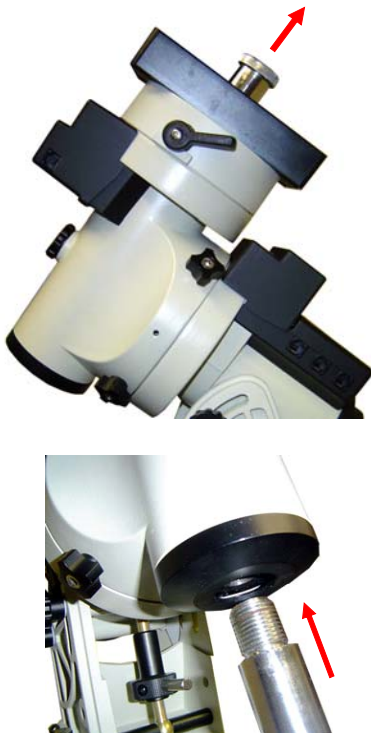

Figure 12

5. **Install counterweight(s):** iEQ45 comes with two 5kg counterweights. Use one or both of them for your particular OTA (Optical Tube Assembly). An optional CW shaft extension or additional CW is available for purchase at www.ioptron.com.
6. **Attach OTA to mount and balance:** After attaching an OTA and accessories to the mount, the iEQ45 must be balanced to ensure minimum stress on the mount (such as gears and motors inside). There are four (4) Clutch Screws on both DEC and R.A. axes. Please refer to the full manual for balance procedures/tips.

7. **Connect cables:** Attach one end of an RJ-11 cable into the socket on the side of the DEC unit and the other end into the DEC socket located on RA unit. Use another RJ-11 cable to connect the hand controller to the HBX socket located on the RA unit. Plug 12V DC power supply into the POWER socket on RA unit. The red LED will be on when the power switch is turned on.
8. **Setup Controller:** The time and site information of the observation location needs to be entered for precise GOTO.

Turn the mount power on. Wait for controller lights on. Press the MENU button. Move the cursor to “**Set Up Controller**” and press ENTER. Select “**Set Up Time & Site**” and press ENTER.



Figure 13

Enter the date and check if it is Daylight Saving Time using arrow keys and number keys. Enter your time zone (add or subtract 60 minutes per time zone) by entering minutes “behind” UT or “ahead of” UT, such as:

- Boston is 300 minutes “behind” UT
- Los Angeles is 480 minutes “behind” UT
- Rome is 60 minutes “ahead of” UT
- Sydney is 600 minutes “ahead of” UT

All the time zones in North America are “behind” UT.

You may also find your observation longitude and latitude coordinate from your GPS navigator, a GPS capable cell phone or from internet. “W/E” means western/eastern hemisphere; “N/S” means northern/southern hemisphere; “d” means degree; “m” means minute; and “s” means second. Use number keys and arrow keys to enter your location information.

Move the cursor to the end of the screen to select Northern or Southern Hemisphere.

9. **Polar alignment:** In order for an equatorial mount to track properly, it has to be accurately polar aligned. With the proprietary AccuAligning™ Polar Scope and Quick Polar Alignment procedure, you can do a fast and accurate polar alignment.

Polar axis adjustment: Loosen Azimuth Locking T-Bolts, adjust the Azimuth Adjustment Knobs to do a fine adjustment of the mount in the azimuth direction. Tighten the locking T-bolts to secure the mount. Loosen four Latitude Lock Screws on the side of the mount, turning the Latitude Adjustment Knob so that the latitude reading from the Latitude Mark Window equals to your local latitude. Use the Lever for a fine latitude adjustment. Re-tighten the locking lock screws.

Quick Polar Alignment:

- (1) Take off the Polar Axis Cover and Polar Scope Cover;
- (2) Thread the dark field illuminating LED into the thread-in hole on a polar scope. Plug the LED cable into the Reticle socket located on the RA unit. The illumination intensity can be adjusted using the HC via “**Set Eyepiece Light**” function under “**Set Up Controller**” menu;
- (3) Use the “▲” or “▼” button to turn the DEC axis to unblock the Polar Scope view (there is a hole on the DEC axis). You may loosen the DEC clutch to turn the DEC axis without rotating the telescope;

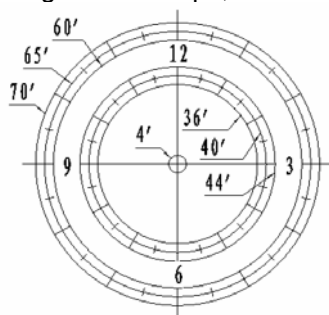

Figure 14

- (4) Use the “◀” or “▶” button to turn the RA axis to rotate the Polar Scope dial to a clock position where 12 is at the top, as shown in **Figure 14**. You may release the R.A. Locking Screws and hold the OTA while turning the R.A. axis;
- (5) Press the **MENU** button, then select “**Align**” and “**Pole Star Position**” to display the Pole Star Position on the LCD screen. Shown in **Figure 15(a)** is Polaris position in northern hemisphere. For example, May 30, 2010, 20:00:00 in Boston, US (alt N42°30'32” and long W71°08'50”), 300 min behind UT, the Polaris Position is 1h26.8m and 41.5m.
(If you are located in the southern hemisphere, Sigma Octantis will be used as the reference for polar alignment.)

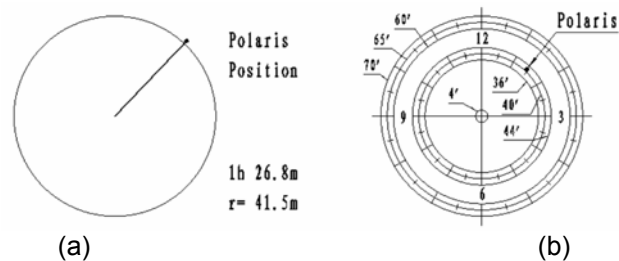

Figure 15

- (6) Follow **Polar Axis Adjustment** procedure to adjust the mount in altitude and azimuth directions and put the Polaris in the same position on the Polar Scope Dial as indicated on the HC LCD, as shown in **Figure 15 (b)**.

BrightStar Polar Alignment

If the mount is not equipped with a polar scope or the pole star cannot be seen, you can use BrightStar Polar Alignment procedure from the hand controller:

- (1) Level the iEQ45 mount and set it at Zero Position. Make sure the telescope is parallel to the pole axis (R.A. axis) of the mount. If a finder scope is used, adjust it to be parallel to the telescope optical axis. Set correct R.A. and DEC back lash numbers. An eyepiece with cross hairs is recommended.
 - (2) Power on the mount. Press the **MENU** button, then select “**Align**” and “**Polar Alignment**”. The HC will display the azimuth and altitude position of several bright stars near meridian. Select one that is visible from the site as aligning Star A. Follow the on screen instruction to move the Star A to the center of the eyepiece with a combination of Latitude Adjustment Knob and the “◀” or “▶” button. Press ENTER to confirm. Then select a bright star that is close to the horizon as aligning Star B. Center it using the Azimuth Adjustment Knob and “◀” or “▶” button (*The “▲” and “▼” buttons are disabled during the process*). Press ENTER to confirm.
 - (3) The telescope will point to Star A again and repeat above steps until the error is minimum, or at your decision. Press the BACK button to exit alignment procedure.
10. **Adjust the Mount to Zero Position:** The Zero Position is the position where the counterweight shaft points to ground, telescope is at the highest position with its axis parallel to the polar axis and the telescope is pointing to the Celestial Pole. Loosen the DEC and R.A. Clutches to adjust the mount to the Zero Position. Tighten the screws after each adjustment. Power the mount OFF/ON.
 11. **Manual Operation of the Mount:** Now you can observe astronomical objects using the arrow keys of the Go2Nova® hand controller. Flip the I/O switch on

the telescope mount to turn on the mount. Use ►, ◀, ▼ or ▲ buttons to point the telescope to the desired object. Use the number keys to change the slewing speed. Then press **STOP/0** button to start tracking.

- Star Alignment:** Star alignment will improve the GOTO accuracy. From the main menu select **“Align”**. Select **“One Star Align”** and press ENTER. The screen will display “Adjust telescope to Zero Position.” Press ENTER. A list of align stars that are above the horizon is computed based on your local time and location. Select a star and press ENTER. Use arrow buttons to center the star in your eyepiece. Use number keys to adjust the slew speed while centering the object. (1 for slowest, 9 for maximum). Press ENTER when finished. To increase the accuracy you may choose to do multi-star alignment. **Note: two star alignment should be performed after one star alignment.**

- Go to an Object:** The mount is now ready to GOTO and track targets. Press MENU button, select **“Select and Slew”** and press ENTER. Select a category (ex. **“planets, sun, moon”**). Then select an object (ex. “moon”). Then press ENTER. The telescope will automatically slew to the object and lock on. It will automatically begin to track once it locks on to the object.

- Sync to Target:** If the star is not in the center of the eyepiece, one can use this function to center and synchronize the object to improve the local GOTO accuracy. Press MENU button and select **“Sync. To Target.”** Press ENTER. Next use the arrow keys to move object until it is centered in your eyepiece. Then press ENTER again on the hand controller. A **Select and Slew** has to be performed before **“Sync to Target”** operation. This is most useful if you are looking for some faint objects near a bright star. **“Sync to Target”** is similar to “one star alignment”.

- Identify Nearby Bright Objects:** After slewing to an object using hand controller, a list of nearby bright object(s) will be displayed by pressing the “?” button.

Convert EQ to AA

- Remove the iEQ45 mount from a pier or tripod and make sure it is positioned upright.
- Remove Polar Scope Cover and unthreaded Polar Scope from the mount.
- Lay down the mount head and unscrew top two (2) Latitude Locking Screws (**Figure 16**). Keep two metal

washers in a safe place which will be needed when converting the mount back to EQ mode.

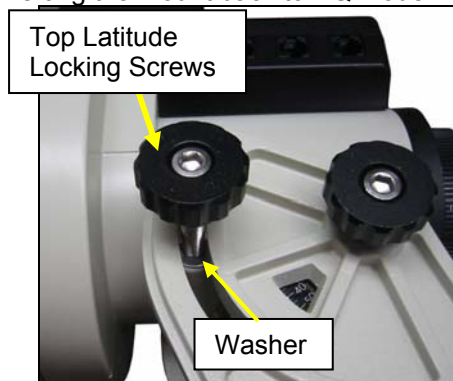

Figure 16

- Remove Latitude Adjustment Lever. Turn the Latitude Adjustment Knob until it separates the top and bottom latitude posts (**Figure 17**). Remove the other two Latitude Locking Screws to separate the mount head from the EQ base.

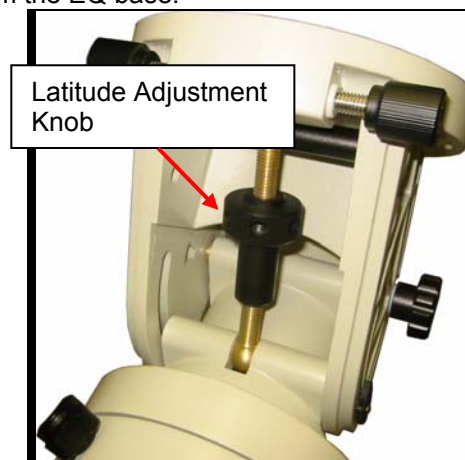

Figure 17

- Remove the Latitude Scale, which is secured onto the mount with a Fixing Screw, as shown in **Figure 18**. Do not break the plastic scale. These parts are needed when converting the mount back to EQ mode.

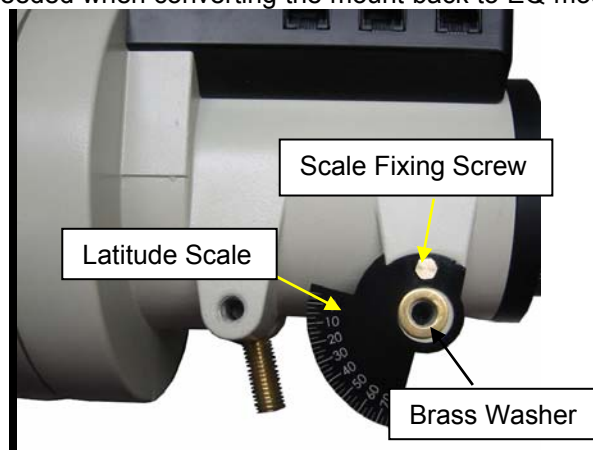



Figure 18

21. Thread Vertical Locking Nut onto the top brass latitude post of the mount (Figure 19).

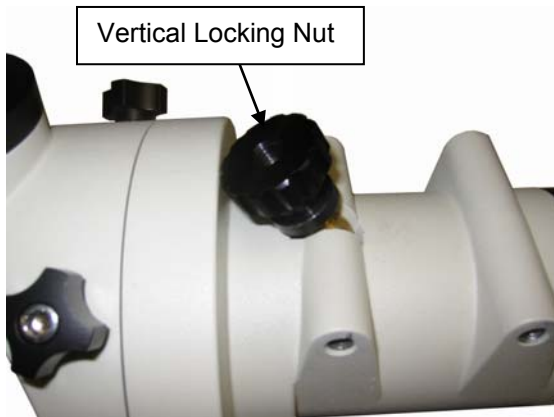

Figure 19

22. Retract two Adjustable Washers on the AZ base (Figure 20).

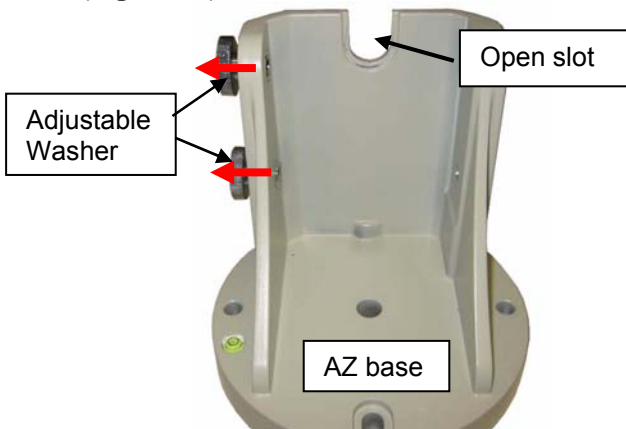

Figure 20

23. Place the AZ base onto the mount head with Vertical Locking Nut placed in the open slot on AZ base (Figure 21). Be careful that the mount will be bottom heavy.

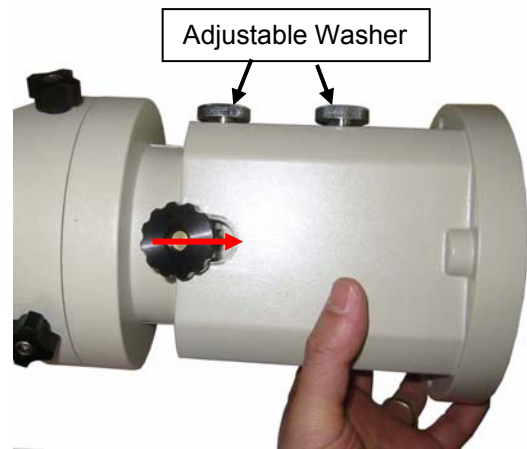

Figure 21

24. Align the mounting holes on the AZ base to the Latitude Locking Screw holes on the mount head. Insert 4 Latitude Locking Screws into them. Tighten the Adjustable Washers. Loosely tighten 4 Latitude Locking Screws. Tighten the Vertical Locking Nut. Then tighten the Latitude Locking Screws.

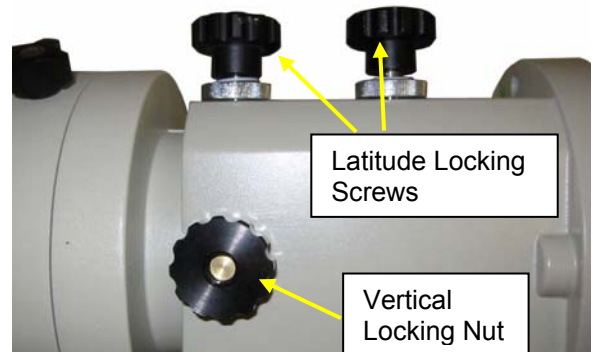

Figure 22

25. Replace the Polar Axis Cover with the one with a spirit bubble level.



Figure 23

26. Install the mount onto the pier/tripod top. Level the mount by adjusting the tripod legs or pier feet (Refer

- to **STEP 1**). Use the spirit bubble level on the Polar Axis Cover.
27. Attach your telescope onto the mount. Add counterweight(s) to balance the scope. You may do a rough torque calculation to determine the CW quantity and position. Or if you're using in EQ mode -- mark the position. The mount can only hold a light payload without counterweight(s). Double check the leveling of the system.
 28. Release four R.A. clutch screws. Adjust the mount so that the CW shaft is pointed to East and the telescope is on the West side of the mount. Adjust the telescope to point to Zenith. This is "Zero Position" for operating in AA mode.

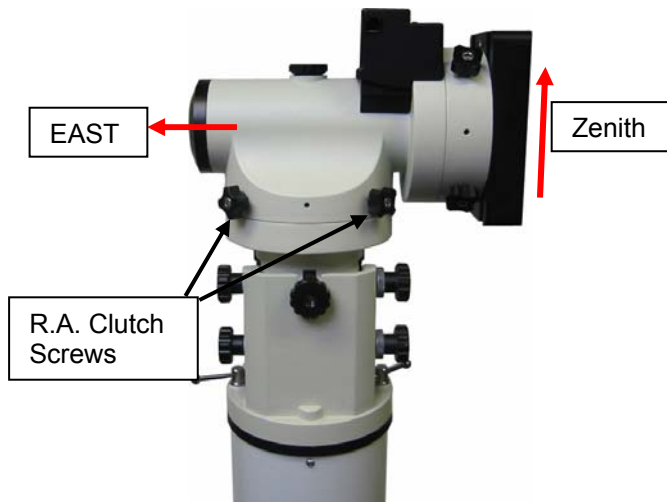

Figure 24

29. Connect the hand controller, DEC cable and power supply and turn the mount on.
30. Set the hand controller by following the iEQ45 initial set up for time and site information. Set the mount to ALT-AZI mode. Power the mount OFF/ON to complete the mode switching.



Figure 25

31. Use "**One Star Align**" to correct any initial misalignment. Or use "**Select and Slew**" to a known star, loosen the AZI (RA) and ALT(DEC) clutch/screws, push the mount to center the star in the eyepiece, relock the clutch/screws. Now your mount is ready to go.

For technical support you can email support@ioptron.com

IOPTRON TWO YEAR TELESCOPE, MOUNT, AND CONTROLLER WARRANTY

A. iOptron warrants your telescope, mount, or controller to be free from defects in materials and workmanship for two years. iOptron will repair or replace such product or part which, upon inspection by iOptron, is found to be defective in materials or workmanship. As a condition to the obligation of iOptron to repair or replace such product, the product must be returned to iOptron together with proof-of-purchase satisfactory to iOptron.

B. The proper Return Merchant Authorization (RMA) number must be obtained from iOptron in advance of return. Contact iOptron via e-mail at support@ioptron.com or call at 1.781.569.0200 to receive the RMA number to be displayed on the outside of your shipping container.

All returns must be accompanied by a written statement stating the name, address, and daytime telephone number of the owner, together with a brief description of any claimed defects. Parts or product for which replacement is made shall become the property of iOptron.

The customer shall be responsible for all costs of transportation and insurance, both to and from the factory of iOptron, and shall be required to prepay such costs.

iOptron shall use reasonable efforts to repair or replace any telescope, mount, or controller covered by this warranty within thirty days of receipt. In the event repair or replacement shall require more than thirty days, iOptron shall notify the customer accordingly. iOptron reserves the right to replace any product which has been discontinued from its product line with a new product of comparable value and function.

This warranty shall be void and of no force of effect in the event a covered product has been modified in design or function, or subjected to abuse, misuse, mishandling or unauthorized repair. Further, product malfunction or deterioration due to normal wear is not covered by this warranty.

IOPTRON DISCLAIMS ANY WARRANTIES, EXPRESS OR IMPLIED, WHETHER OF MERCHANTABILITY OF FITNESS FOR A PARTICULAR USE, EXCEPT AS EXPRESSLY SET FORTH HERE. THE SOLE OBLIGATION OF IOPTRON UNDER THIS LIMITED WARRANTY SHALL BE TO REPAIR OR REPLACE THE COVERED PRODUCT, IN ACCORDANCE WITH THE TERMS SET FORTH HERE. IOPTRON EXPRESSLY DISCLAIMS ANY LOST PROFITS, GENERAL, SPECIAL, INDIRECT OR CONSEQUENTIAL DAMAGES WHICH MAY RESULT FROM BREACH OF ANY WARRANTY, OR ARISING OUT OF THE USE OR INABILITY TO USE ANY IOPTRON PRODUCT. ANY WARRANTIES WHICH ARE IMPLIED AND WHICH CANNOT BE DISCLAIMED SHALL BE LIMITED IN DURATION TO A TERM OF TWO YEARS FROM THE DATE OF ORIGINAL RETAIL PURCHASE.

Some states do not allow the exclusion or limitation of incidental or consequential damages or limitation on how long an implied warranty lasts, so the above limitations and exclusions may not apply to you.

This warranty gives you specific legal rights, and you may also have other rights which vary from state to state.

iOptron reserves the right to modify or discontinue, without prior notice to you, any model or style telescope.

If warranty problems arise, or if you need assistance in using your telescope, mount, or controller contact:

iOptron Corporation
Customer Service Department
6F Gill Street
Woburn, MA 01801
www.ioptron.com
support@ioptron.com
Tel. (781)569-0200
Fax. (781)935-2860
Monday-Friday 9AM-5PM EST

NOTE: This warranty is valid to U.S.A. and Canadian customers who have purchased this product from an authorized iOptron dealer in the U.S.A. or Canada or directly from iOptron. Warranty outside the U.S.A. and Canada is valid only to customers who purchased from an iOptron Distributor or Authorized iOptron Dealer in the specific country. Please contact them for any warranty.