

**INSTRUCTION MANUAL  
AUTO TRACKING TOTAL STATION**

---

**GTS-820A SERIES**  
**GTS-821A**  
**GTS-822A**  
**GTS-823A**  
**GTS-825A**



# FOREWORD

Thank you for purchasing the TOPCON Auto Tracking Total Station, GTS-820A series. For the best performance of the instruments, please carefully read these instructions and keep them in a convenient location for future reference.

## General Handling Precautions

**Before starting work or operation, be sure to check that the instrument is functioning correctly with normal performance.**

**Do not submerge the instrument into water.**

The instrument can not be submerged underwater.

The instrument is designed based on the International Standard IP54, therefore it is protected from the normal rainfall.

**Setting the instrument on a tripod**

When mounting the instrument on a tripod, use a wooden tripod when possible. The vibrations that may occur when using a metallic tripod can effect the measuring precision.

**Installing the tribrach**

If the tribrach is installed incorrectly, the measuring precision could be effected. Occasionally check the adjusting screws on the tribrach. Make sure the base fixing lever is locked and the base fixing screws are tightened.

TR-5 or TR-5P tribrach should be used for prism side when the traverse surveys is performed.

**Guarding the instrument against shocks**

When transporting the instrument, provide some protection to minimize risk of shocks. Heavy shocks may cause the measurement to be faulty.

**Carrying the instrument**

Always carry the instrument by its handgrip.

**Exposing the instrument to extreme heat.**

Do not leave the instrument in extreme heat for longer than necessary. It could adversely affect its performance.

**Sudden changes of temperature**

Any sudden change of temperature to the instrument or prism may result in a reduction of measuring distance range, i.e when taking the instrument out from a heated vehicle. Let instrument acclimate itself to ambient temperature.

**Battery level check**

Confirm battery level remaining before operating.

**Memory back up**

The instrument has a built in battery for memory back up. If the battery power is low, "Back up battery empty" will display. It is still possible to measure the distance and the angle, but the measured data and the parameter setting can be lost. Contact your dealer, to replace the battery.

**Taking the battery out**

It is recommended not to take the battery out during the power is on. All the data stored is possible gone at that time. So please do your assembling or taking the battery out after the power is off.

**No responsibility**

TOPCON Corporation has no responsibility for loss of data stored in the memory in case unexpected accidents.

**Rotating the instrument and telescope**

Rotation of the instrument or telescope is driven electronically in normal operation.  
Do not disturb the rotation.

**Storage in the case**

Keep the telescope horizontally and turn the instrument to align its mark with the lower base mark (Storage mark). Keep its objective lens side downward. Storing it in the case in any other way may cause damage. Hold the hand grips and base with both hands, when taking the instrument out of the case, or putting the equipment in the case.



**Maintenance for driving parts.**

Every 4,000~5,000 hours operation in total, change grease of driving parts.  
Contact your dealer or TOPCON Head Office for the maintenance.

## Display for Safe Use

In order to encourage the safe use of products and prevent any danger to the operator and others or damage to properties, important warnings are put on the products and inserted in the instruction manuals.

We suggest that everyone understand the meaning of the following displays and icons before reading the "Safety Cautions" and text

Display	Meaning
 <b>WARNING</b>	<b>Ignoring or disregard of this display may lead to the danger of death or serious injury.</b>
 <b>CAUTION</b>	<b>Ignoring or disregard of this display may lead to personal injury or physical damage.</b>

•Injury refers to hurt, burn, electric shock, etc.

•Physical damage refers to extensive damage to buildings or equipment and furniture.

## Safety Cautions

 <b>WARNING</b>
<p>•<b>There is a risk of fire, electric shock or physical harm if you attempt to disassemble or repair the instrument yourself.</b> This is only to be carried out by TOPCON or an authorized dealer, only!</p>
<p>•<b>Cause eye injury or blindness.</b> Do not look at the sun through a telescope.</p>
<p>•<b>Laser beams can be dangerous, and can cause eye injury's if used incorrectly.</b> Never attempt to repair the instrument yourself.</p>
<p>•<b>Cause eye injury or blindness.</b> Do not stare into beam.</p>
<p>•<b>High temperature may cause fire.</b> Do not cover the charger while it is charging.</p>
<p>•<b>High temperature may cause fire.</b> Do not connect the battery to an instrument while it is charging.</p>
<p>•<b>Risk of fire or electric shock.</b> Do not use damaged power cable, plug and socket.</p>
<p>•<b>Risk of fire or electric shock.</b> Do not use a wet battery or charger.</p>
<p>•<b>May ignite explosively.</b> Never use an instrument near flammable gas, liquid matter, and do not use in a coal mine.</p>
<p>•<b>Battery can cause explosion or injury.</b> Do not dispose in fire or heat.</p>
<p>•<b>Risk of fire or electric shock.</b> Do not use any power voltage except the one given on manufacturers instructions.</p>
<p>•<b>Battery can cause outbreak of fire.</b> Do not use any other type of charger other than the one specified.</p>
<p>•<b>Risk of fire.</b> Do not use any other power cable other than the one specified.</p>
<p>•<b>Battery can cause outbreak of fire.</b> Do not block up the vent of the battery.</p>
<p>•<b>The short circuit of a battery can cause a fire.</b> Do not short circuit battery when storing it.</p>

 <b>CAUTION</b>
Use of controls or adjustment or performance of procedures other than those specified herein may result in hazardous radiation exposure.
Let the laser beam reach the aimed object or the target without anybody else in the laser beam path. In case you operate laser beam open, avoid radiating laser beam to the height of man's head. It is quite possible for the beam to enter into one's eyes, and it is possible to lose visual sight temporarily, and lose one's caution and awareness of other dangers - avoid glaring beam.
Do not connect or disconnect equipment with wet hands, you are at risk of electric shocks if you do!
Risk of injury by overturn the carrying case. Do not stand or sit on the carrying cases.
Please note that the tips of tripod can be hazardous, be aware of this when setting up or carrying the tripod.
Risk of injury by falling down the instrument or case. Do not use a carrying case with a damaged which belts, grips or latches.
Do not allow skin or clothing to come into contact with acid from the batteries, if this does occur then wash off with copious amounts of water and seek medical advice.
A plumb bob can cause an injury to a person if used incorrectly.
It could be dangerous if the instrument falls over, please ensure you attach a handle battery to the instrument securely.
Ensure that you mount the Tribrach correctly, failing to do so may result in injury if the tribrach were to fall over.
It could be dangerous if the instrument falls over, please check that you fix the instrument to the tripod correctly.
Risk of injury by falling down a tripod and an instrument. Always check that the screws of tripod are tightened.

## User

1) This product is for professional use only!

The user is required to be a qualified surveyor or have a good knowledge of surveying, in order to understand the user and safety instructions, before operating, inspecting or adjusting.

2) Wear the required protectors (safety shoes, helmet, etc.) when operating.

## Exceptions from Responsibility

- 1) The user of this product is expected to follow all operating instructions and make periodic checks of the product's performance.
- 2) The manufacturer, or its representatives, assumes no responsibility for results of a faulty or intentional usage or misuse including any direct, indirect, consequential damage, and loss of profits.
- 3) The manufacturer, or its representatives, assumes no responsibility for consequential damage, and loss of profits by any disaster, (an earthquake, storms, floods etc.).  
A fire, accident, or an act of a third party and/or a usage any other usual conditions.
- 4) The manufacturer, or its representatives, assumes no responsibility for any damage, and loss of profits due to a change of data, loss of data, an interruption of business etc., caused by using the product or an unusable product.
- 5) The manufacturer, or its representatives, assumes no responsibility for any damage, and loss of profits caused by usage except for explained in the user manual.
- 6) The manufacturer, or its representatives, assumes no responsibility for damage caused by wrong movement, or action due to connecting with other products.

## Laser Safety

GTS-820A series uses the visible laser beam for auto tracking, optical communication. The GTS-820A series products are manufactured and sold in accordance with "Radiation Safety of Laser Products, Equipment Classification, Requirements and User's Guide" (IEC Publication 60825-1) or "Performance Standards for Light-Emitting Products" (FDA/BRH 21 CFR 1040) provided on the safety standards for laser beam.

As per the said standards, GTS-820A series is classified as "Class 2 (CLASS II) Laser Products". The laser beam belongs not very dangerous type but we request you to keep and understand "Safety standard for users" as mentioned in the manual instruction.

In case of any failure, do not disassemble the instrument. Contact TOPCON or your TOPCON dealer.

Laser class of each mode is as follows.

Mode	Laser class
Autotracking	Class 1 (CLASS II)
Optical communication	Class 2 (CLASS II)

### Labels

Find the labels which describes the caution and safety about the laser beam as follows in GTS-820A series.

We request you to replace it one anytime the caution labels are damaged or lost and paste a new one at the same place. You can get the labels from Topcon or your dealer.

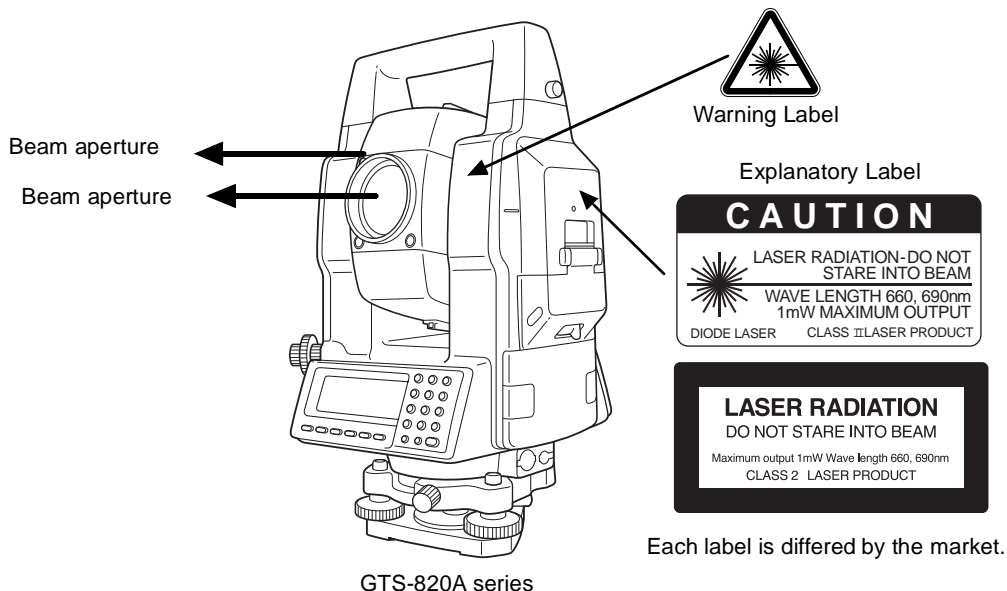

Each label is differed by the market.

### Symbol marks while the laser is emitting.

The following symbol marks of instrument status will indicate that the laser is emitting.

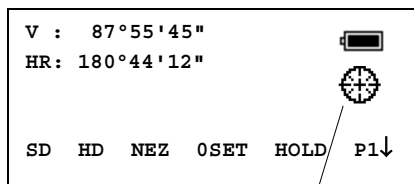

The symbol mark

Marks	Status of instrument
	Auto-collimating
	Auto-tracking
	Waiting
	Searching

## Contents

<b>FOREWORD</b> .....	<b>1</b>
General Handling Precautions .....	1
Display for Safe Use .....	3
Safety Cautions .....	3
User .....	4
Exceptions from Responsibility .....	4
Laser Safety .....	5
Contents .....	6
Standard Set Composition .....	9
<b>1 NOMENCLATURE AND FUNCTIONS</b> .....	<b>1-1</b>
1.1 Nomenclature .....	1-1
1.2 Display .....	1-3
1.3 Operating Key .....	1-4
1.4 Function Key (Soft Key) .....	1-5
1.5 Star key (*key) mode .....	1-7
1.6 Auto Power Off .....	1-11
1.7 Data Output .....	1-11
1.8 Rotating Method .....	1-11
1.8.1 Rotating by H/V Shuttle and H/V Jog .....	1-11
1.8.2 Auto Inversion .....	1-11
1.8.3 Rotating automatically to a required Horizontal and Vertical angle .....	1-11
1.9 Using together with RC-2II Remote Control System .....	1-12
1.10 Using connecting with Personal Computer (PC) .....	1-13
<b>2 PREPARATION FOR MEASUREMENT</b> .....	<b>2-1</b>
2.1 Power Connection .....	2-1
2.2 Setting Instrument Up For Measurement .....	2-2
2.3 Power Switch Key ON .....	2-3
2.4 Battery Level Indicator .....	2-4
2.5 Main Menu Icons .....	2-5
2.6 Vertical and Horizontal Angle Tilt Correction .....	2-6
2.7 Compensation of Systematic Error of Instrument .....	2-7
2.8 Resume Mode ON/OFF .....	2-8
2.9 How to Enter Numerals and Alphabet Letters .....	2-8
2.10 Memory Card .....	2-9
2.11 Inclination of Prism and Measuring Error .....	2-10
<b>3 AUTOMATIC TRACKING / AUTOMATIC COLLIMATION</b> .....	<b>3-1</b>
3.1 Automatic Tracking .....	3-1
3.2 Automatic Collimation .....	3-3
3.3 Range of Laser for Auto-tracking and Auto-collimating .....	3-4
3.4 Setting Parameters for Auto-Tracking .....	3-5
3.4.1 Setting Items .....	3-5
3.4.2 How to set the parameters .....	3-7
<b>4 STANDARD MEASUREMENT MODE</b> .....	<b>4-1</b>
4.1 Angle Measurement .....	4-1
4.1.1 Measuring Horizontal Angle Right and Vertical Angle .....	4-1
4.1.2 Switching Horizontal Angle Right/Left .....	4-2
4.1.3 Measuring from the Required Horizontal Angle .....	4-2
4.1.4 Vertical Angle Percent Grade(%) Mode .....	4-3
4.1.5 Automatic Rotation to a Required Horizontal and Vertical Absolute Angle .....	4-4
4.2 Distance Measurement .....	4-5
4.2.1 Setting of the Atmospheric Correction .....	4-5
4.2.2 Setting of the Correction for Prism Constant .....	4-5
4.2.3 Distance Measurement (Continuous Measurement) .....	4-5
4.2.4 Distance Measurement (Single/N-times Measurement) .....	4-6
4.2.5 Fine / Coarse Measuring Mode .....	4-8
4.2.6 Stake Out (S-O) .....	4-9
4.3 COORDINATE MEASUREMENT .....	4-10
4.3.1 Setting Coordinate Values of Occupied Point .....	4-10
4.3.2 Setting of the Instrument Height / Prism Height .....	4-12
4.3.3 Execution of Coordinate Measuring .....	4-13









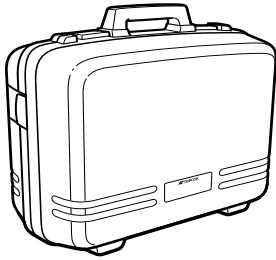

4.4 DATA OUTPUT .....	4-15
<b>5 PROGRAM MODES .....</b>	<b>5-1</b>
5.1 Setting a Direction Angle for Backsight Orientation .....	5-2
5.2 Retaining a Coordinate (STORE- NEZ) .....	5-3
5.3 Remote Elevation measurement (REM) .....	5-5
5.4 Missing Line Measurement (MLM) .....	5-8
5.5 Line Measurement (LINE) .....	5-11
5.6 Offset measurement (OFFSET) .....	5-14
5.6.1 Angle Offset .....	5-15
5.6.2 Distance Offset Measurement .....	5-17
5.6.3 Plane Offset Measurement .....	5-19
5.6.4 Column Offset Measurement .....	5-21
5.7 External Link .....	5-23
5.7.1 Starting compatible communication program of AP-L1A .....	5-23
5.7.2 Setting for the communication .....	5-23
5.7.3 Carrying out Communication .....	5-27
<b>6 MEMORY MANAGE MODES .....</b>	<b>6-1</b>
6.1 View Internal Memory and Card Memory Status .....	6-1
6.2 Protect a File .....	6-2
6.3 Rename a File .....	6-2
6.4 Deleting a File .....	6-3
6.5 Copy a File .....	6-3
6.6 Initializing Memory .....	6-4
<b>7 COMMUNICATION MODES .....</b>	<b>7-1</b>
7.1 Setting of PROTOCOL .....	7-1
7.2 Data File In .....	7-2
7.3 Data File Out .....	7-2
<b>8 PARAMETERS SETTING MODE .....</b>	<b>8-1</b>
8.1 Parameter Setting Options .....	8-1
8.1.1 Parameters for Measurement and Display .....	8-1
8.1.2 Parameters for communication .....	8-3
8.2 Setting Parameters .....	8-5
8.2.1 Parameters for Measurement and Display .....	8-5
8.2.2 Parameters for Communication .....	8-6
8.2.3 Password Option .....	8-6
<b>9 CHECK AND ADJUSTMENT .....</b>	<b>9-1</b>
9.1 Checking and Adjusting of Instrument Constant .....	9-1
9.2 Checking the Optical Axis .....	9-2
9.3 Checking/Adjusting the Theodolite Functions .....	9-4
9.3.1 Checking /Adjusting the Plate Level .....	9-5
9.3.2 Checking /Adjusting the Circular Level .....	9-5
9.3.3 Adjustment of the Vertical Cross-hair .....	9-6
9.3.4 Collimation of the Instrument .....	9-7
9.3.5 Checking / Adjusting the Optical Plummet Telescope .....	9-8
9.4 Adjustment of Compensation Systematic Error of Instrument .....	9-9
9.5 Showing Constant List and Switch ON/OFF .....	
Compensation Systematic Error of Instrument .....	9-11
9.6 How to adjust the date and time .....	9-12
9.7 How to Set the Instrument Constant Value .....	9-13
9.8 Reference Frequency Checking Mode .....	9-14
9.9 Inspection and Adjustment of Optic Axis for Auto -Tracking .....	9-15
<b>10 SETTING THE PRISM CONSTANT VALUE .....</b>	<b>10-1</b>
<b>11 SETTING ATMOSPHERIC CORRECTION .....</b>	<b>11-1</b>
11.1 Calculation of Atmospheric Correction .....	11-1
11.2 Setting of Atmospheric Correction Value .....	11-1
<b>12 CORRECTION FOR REFRACTION AND EARTH CURVATURE ...</b>	<b>12-1</b>
12.1 Distance Calculation Formula .....	12-1
<b>13 POWER SOURCE AND CHARGING .....</b>	<b>13-1</b>
13.1 Rechargeable Battery BT-56Q .....	13-1

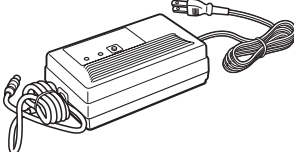
<b>14 DETACH/ATTACH OF TRIBRACH.....</b>	<b>14-1</b>
<b>15 BATTERY SYSTEM.....</b>	<b>15-1</b>
<b>16 PRISM SYSTEM .....</b>	<b>16-1</b>
<b>17 PRECAUTIONS.....</b>	<b>17-1</b>
<b>18 ERROR DISPLAYS.....</b>	<b>18-1</b>
<b>19 SPECIAL ACCESSORIES.....</b>	<b>19-1</b>
<b>20 SPECIFICATIONS.....</b>	<b>20-1</b>
<b>APPENDIX .....</b>	<b>APPENDIX-1</b>
Dual Axis Compensation.....	APPENDIX-1
Precaution when Charging or Storing Batteries.....	APPENDIX-3

## Standard Set Composition

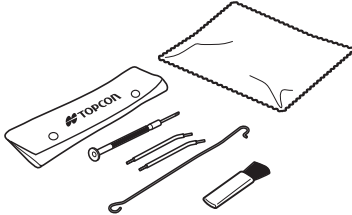
The numerical value in parentheses shows the quantity.

<p>GTS-820A series (with lens cap) (1)</p> 	<p>Plastic carrying case (1)</p> 
<p>Battery BT-56Q (2)</p> 	<p>Battery charger BC-27BR or BC-27CR (1)</p> 
<p>Sun shade (1)</p> 	<p>Plastic rain cover (1)</p> 
<p>Plumb bob set (1)</p>  <p>Plumb bob hook is included in the tool kit case.</p>	<p>Tool kit with case [ rod pins, Plumb bob hook, screwdriver, cleaning brush ] (1)</p> 
<p>Instruction manual (1)</p> 	

(Make sure that all of the above items are with the instrument when purchased.)

**Remarks:**

- 1) Battery charger BC-27CR is for AC 230V use and BC-27BR is for AC 120V use.
- 2) Plumb bob set and plumb bob hook are supplied for certain markets.

# 1 NOMENCLATURE AND FUNCTIONS

## 1.1 Nomenclature

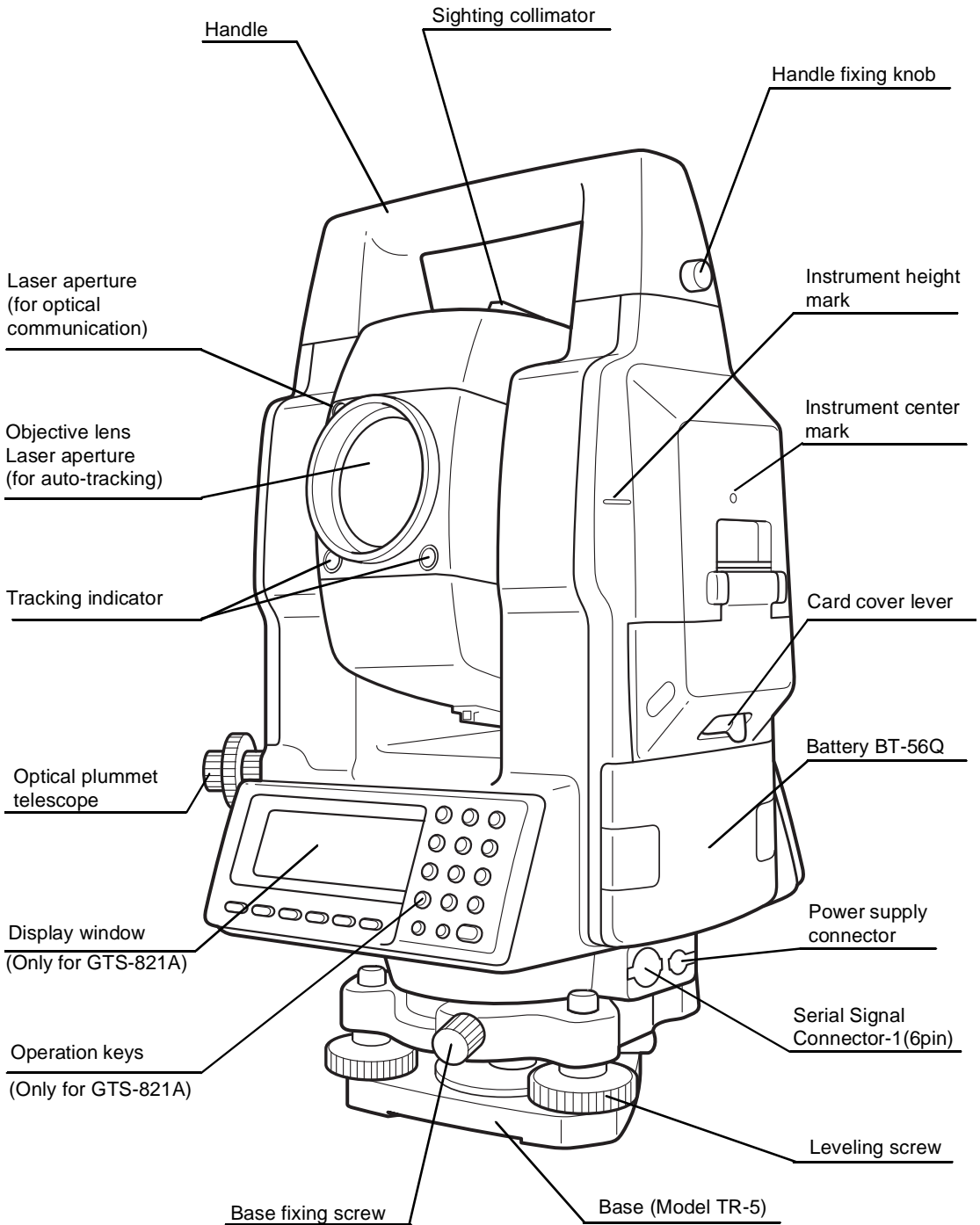

The caution labels are pasted up GTS-820A series which describe the warning of laser beam. Refer to "Laser Safety" about label positions and their shapes.

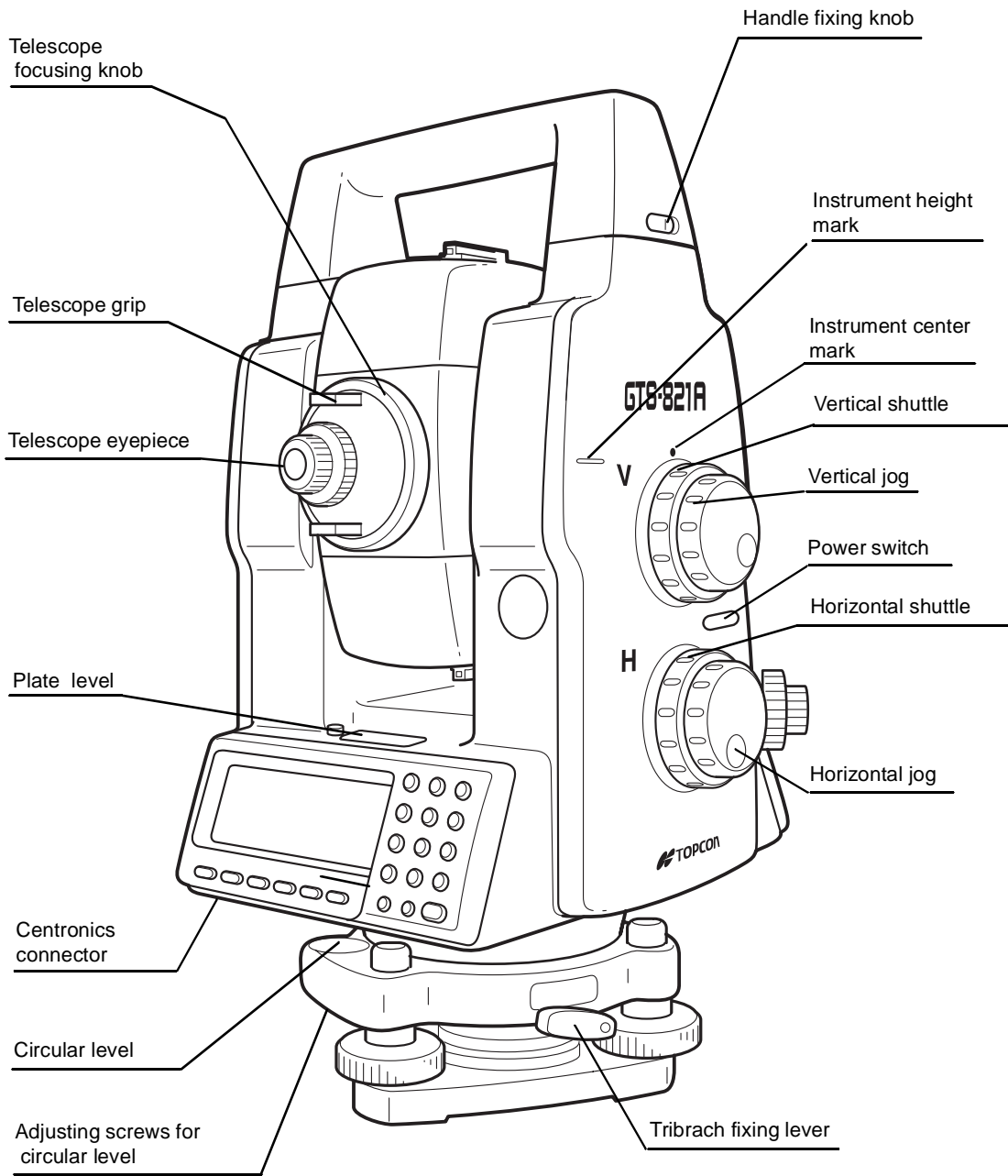

## 1.2 Display

- **Display**  
In general upper four lines display the measuring data, and the bottom line displays the soft key function which is changed by the measuring mode.
- **Contrast**  
The contrast and illumination of display window are adjusted by star (H) key.
- **Heater (Automatic)**  
The built-in heater keeps the display functional when the temperature goes below 0°C (32 °F). To switch the heater ON or OFF, refer to Chapter 8 “PARAMETERS SETTING MODE”.  
When the heater is ON and the temperature goes below 0°C.(32 °F), the heater automatically adjust the temperature to the display to keep it operating.
- **Example**

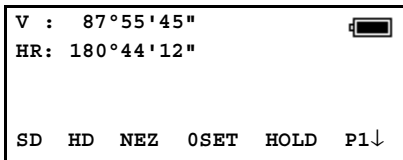

Angle measurement mode

V-angle : 87°55'20"  
H-angle : 180°44'12"

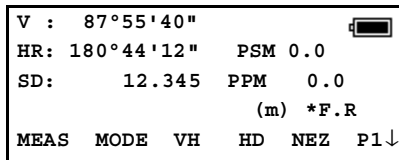



Distance measurement mode





Horizontal-angle : 87°55'40"  
Horizontal distance : 180°44'12"  
Relative elevation : 12.345m

- **Display marks**

Display	Contents	Display	Content
V	V-angle	*	EDM working
V%	Percent grade	(m)	Meter unit
HR	H-angle right	(f)	Feet unit
HL	H-angle left	F	Fine mode
HD	Horizontal distance	C	Coarse mode (1mm)
VD	Relative elevation	T	Tracking mode (10mm)
SD	Slope distance	R	Repeat measurement
N	N coordinate	S	Single measurement
E	E coordinate	N	N-times measurement
Z	Z coordinate	ppm	Atmospheric correction value
		psm	Prism constant value

	Battery Level Indicator Refer to Section 2.4 “Battery Level Indicator” for further information.		Rotation Indicator Refer to Section 1.8 “Rotating Method” for further information.
---	--	---	---

1 The symbol marks for Auto-tracking and Auto-collimating

	Auto-collimating <b>(Laser is emitting)</b> GTS-820A series is in auto-collimating status.		Auto-tracking <b>(Laser is emitting)</b> GTS-820A series is in auto-tracking status.
	Waiting <b>(Laser is emitting)</b> GTS-820A series is in waiting status.		Searching <b>(Laser is emitting)</b> GTS-820A series is searching a prism.
	Failure in auto-collimating. <b>(Laser is off)</b> GTS-820A series could not find the target prism during auto-collimating.		

1.3 Operating Key

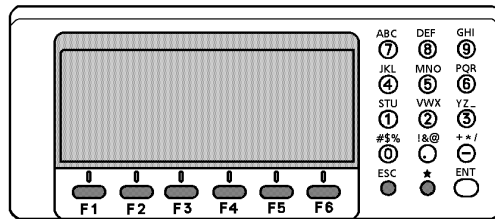

KEY	NAME	FUNCTION
F1-F6	Soft key	Functions are according to the displayed message.
0-9 . -	Numeric key	Numeric Character Entry for Preset Data
A ~/	Alpha key	Alpha Character Entry
ESC	Escape key	Escape to Previous Display or Menu
*	Star key	Optional instrument functions
ENT	Enter key	End operation of data input and accepts data
POWER	Power key	ON/OFF of power source. (Power key is located on the side of the instrument.)

### 1.4 Function Key (Soft Key)

The Soft Key Functions are labeled on the bottom of display. Soft Key functions are different for each measurement.

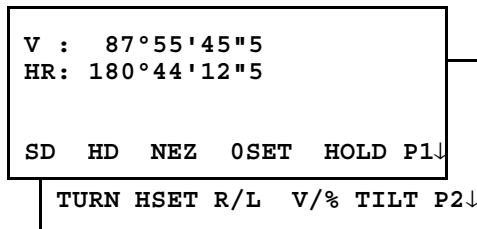
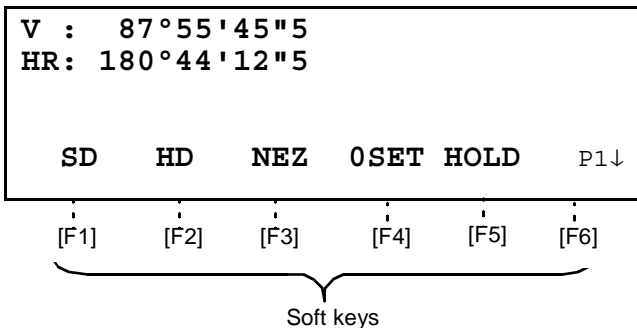

Angle measuring

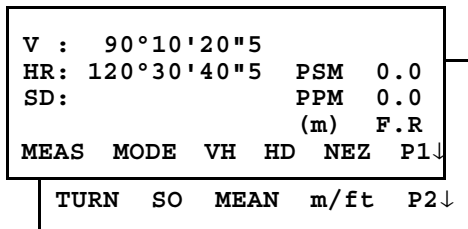

Slope distance measuring

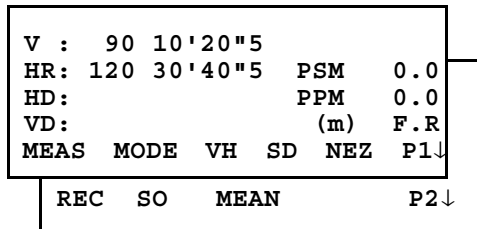

Horizontal distance measuring

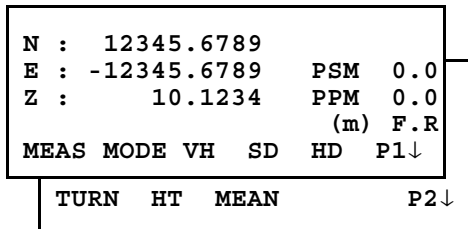

Coordinate measuring

Page	Display	Soft key	Function
Angle measuring	SD	F1	Slope distance measuring mode.
	HD	F2	Horizontal distance measuring mode.
	NEZ	F3	Coordinate distance measuring mode.
	OSET	F4	Set horizontal angle to 0°00'00".
	HOLD	F5	Horizontal angle hold.
	TURN	F1	Turns the instrument to required angle automatically.
	HSET	F2	Preset a horizontal angle.
	R/L	F3	Changes horizontal angle right or left.
	V/%	F4	Changes the display to vertical angle or percent of grade.
TILT	F5	Sets the tilt function, ON/OFF. If ON, the display shows tilt correction value.	



Page	Display	Soft key	Function
Slope distance measuring	MEAS	F1	Starts slope distance measurement mode. Changes Continuous/ N-times (single) measurement mode.
	MODE	F2	Changes Fine / Coarse(1mm) /Coarse(10mm) mode.
	VH	F3	Angle measurement mode.
	HD	F4	Horizontal distance measurement mode. Displays the horizontal distance data after N-times or single measurement.
	NEZ	F5	Coordinate measurement mode. Displays the coordinate after N-times or single measurement.
	TURN	F1	Turns the instrument to required angle automatically.
	SO	F2	Stake out measurement mode.
	MEAN	F3	Sets the number of N-time measurement.
	m/ft	F4	Changes distance measurement unit to meter or feet.
Horizontal distance measuring	MEAS	F1	Starts horizontal distance measurement mode. Changes continuous/ N-times (single) measurement mode.
	MODE	F2	Changes Fine / Coarse(1mm) /Coarse(10mm) mode.
	VH	F3	Angle measurement mode.
	SD	F4	Slope distance measuring mode. Display the slope distance after N-times or single measurement.
	NEZ	F5	Coordinate measurement mode. Displays the coordinate after N-times or single measurement.
	TURN	F1	Turns the instrument to required angle automatically.
	SO	F2	Stake out measurement mode.
	MEAN	F3	Sets the number of N-time measurement.
	m/ft	F4	Switches meter or feet unit.
Coordinate measuring	MEAS	F1	Starts coordinate measurement mode. Changes continuous/ N-times (single) measurement mode.
	MODE	F2	Changes Fine / Coarse(1mm) /Coarse(10mm) mode.
	VH	F3	Angle measurement mode.
	SD	F4	Slope distance measuring mode. Display the slope distance after N-times or single measurement.
	HD	F5	Horizontal distance measurement mode. Displays the horizontal distance data after N-times or single measurement.
	TURN	F1	Turns the instrument to required angle automatically.
	HT	F2	Input Instrument / prism height values.
	MEAN	F3	Sets the number of N-time measurement.
	m/ft	F4	Switches meter or feet unit.
SET	F5	Pre-set instrument coordinate values.	

### 1.5 Star key (\*key) mode

Press the (H) key to view the instrument options. Since there are three screens of options, press [F6](1↓) soft key to view the next screen.

The following instrument options can be selected from the (H):

- Screen One
  - 1) View Date & Time
  - 2) Auto-tracking [F1]
  - 3) Auto-collimating [F2]
  - 4) Set the parameters for Auto-tracking.[F3]
  - 5) Auto- inversion [F4]
  - 6) Electric circular graphic display[F5]
- Screen Two
  - 7) Adjustment the contrast of the display [F1 & F2]
  - 8) Turn the back light of the display ON/OFF [F3]
  - 9) Reticle illumination---Off / Low / Medium / High [F4]
  - 10) View free memory for internal and card memory [F5]
- Screen Three
  - 11) The light acceptance quantity level (signal level) is displayed.[F1]
  - 12) Set the Temperature, Pressure, Atmospheric Correction Value (ppm), and Prism Constant Value (PSM) [F2]
  - 13) Turn the Tracking Indicator option ON/OFF [F3]

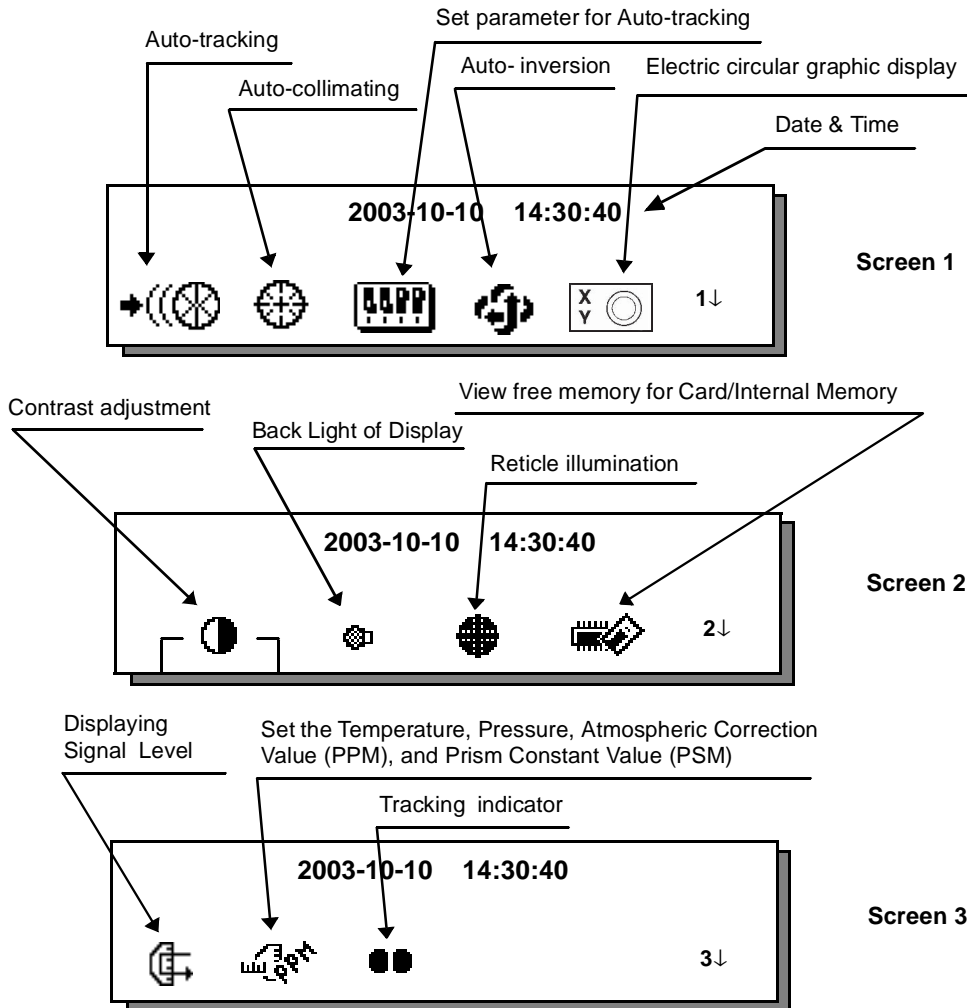

**1) View Date & Time**

The date and time can be viewed on both screens. To change the displayed order of the date, (Date/ Month/Year), (Month / Date / Year) or (Year/Month/Date), see Chapter 8 "PARAMETERS SETTING MODE".

To set the date and time, see Chapter 9 "CHECK AND ADJUSTMENT".

**2) Turn the auto-tracking ON/OFF**

Press the [F1] key to start auto-tracking. See Section 3.1 "Automatic Tracking".

**3) Turn the auto-collimating ON/OFF**

Press the [F2] key to start auto-collimating. See Section 3.2 "Automatic Collimation".

**4) Set the parameters for the auto-tracking**

A proper setting for each parameter such as tracking pattern, tracking range, waiting time, tracking speed and tracking sensitivity. See Section 3.4 "Setting Parameters for Auto-Tracking".

**5) Auto Inversion**

Pressing the [F4] key causes the instrument to reverse and turn the telescope and instrument automatically.

1 To stop auto rotating in case of emergency, press any keys except POWER key.

1 During auto rotation, do not disturb the instrument. (Stopping the rotation with a touch of the hand). Such action may cause trouble or harm to instrument or operator.

**6) Electric circular level graphic display**

Electric circular level can be displayed by graphic. This function is good for level the instrument when the circular level is difficult to see directly.

Press the [F5] key to display the graphic.

In the displays of reverse side, the graphic bubble moves in reverse.

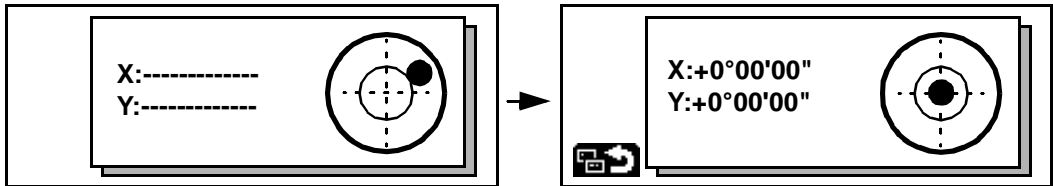

Rotate the leveling screws while observing the display.

After leveling, press [F1]. The display changes to the previous mode.

**7) Adjustment the contrast of the display**

This enable you to adjust the contrast of the display.

Press the [F6] key to get to Screen 2 on the display.

Press the [F1] or [F2] key to brighten or dim the display.

**8) Turn the display back light ON/OFF**

When the back light is OFF, the light bulb icon is dark.

Press the [F6] key to get to Screen 2 on the display.

To turn the back light ON, press the [F3] key. Press [F3] again to turn the back light OFF.

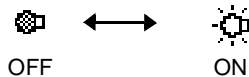

**9) Reticle illumination (OFF/Low/Middle/High)**

Press the [F6] key to get to Screen 2 on the display. Press the [F4] key to turn the reticle illumination ON. Continuing to press [F4] will change the intensity options.

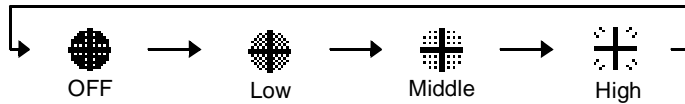

**10) View free memory**

The amount of free memory for the card or internal memory can be displayed.

Press the [F6] key to get to Screen 2 on the display.

Press the [F5] key to view free memory.

The card memory icon (top left side of the display) shows the size of the card and the amount of free memory. The second icon shows the amount of free internal memory.

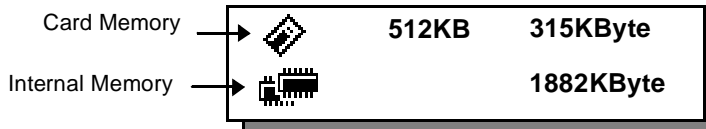

See Chapter 6 “MEMORY MANAGE MODES”, for further options and instructions.

**11) Set audio mode**

The light acceptance quantity level (Signal level) is displayed in this mode.

When reflected light from the prism is received, a buzzer sounds. This function is good for easy collimation when the target is difficult to find.

Press the [F1] key on screen 3.

The received return signal level is displayed with bar graph as follows.

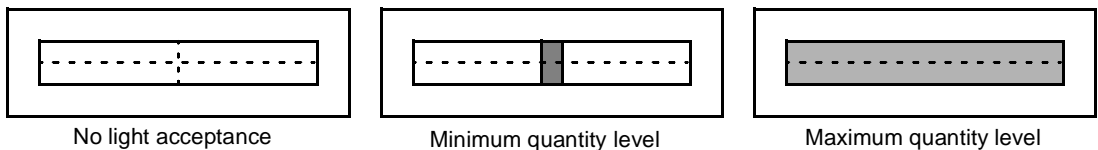

(1) To stop the buzzer, see Chapter 8 “PARAMETERS SETTING MODE”.

(2) Also, it is possible to display the signal level in Distance Measuring Mode.

**12) Setting Temperature, Pressure, Atmospheric correction value (ppm), Prism constant value (PSM)**

The temperature, pressure, PPM, and PSM can be viewed by pressing the [F2] key on screen 3 .

The received return signal level is displayed with bar graph as follows.

Refer to Chapter 10 “SETTING THE PRISM CONSTANT VALUE” and Chapter 11 “SETTING ATMOSPHERIC CORRECTION”, for further instructions.

**13) Tracking Indicator**

A man who is staying on line with the direction of GTS-820A series or automatic tracking status by emitted LED light (orange color) from GTS-820A series.

• **Operation**

Pressing [F3] key on screen three functions Tracking Indicator. The tracking indicator status will be changed according to the type of auto tracking mode and its conditions. A man from the prism side can recognize the status of instrument.

When angle measuring value turns stable during tracking still object, the tracking indicator changes from quick continuous flashing to quick intermittent flashing. So you can decide from the sign of flashing for recording data timing at one person surveying.

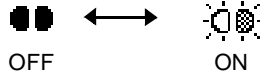

**Meaning of Tracking Indicator ON or Flashing**

Tracking Indicator	Tracking status of instrument
Continuous ON	Wait status
Slow flashing	Manual mode
Quick continuous flashing	In case angle measuring value is instable during auto tracking mode.
Quick intermittent flashing	In case angle measuring value is stable during auto tracking mode.

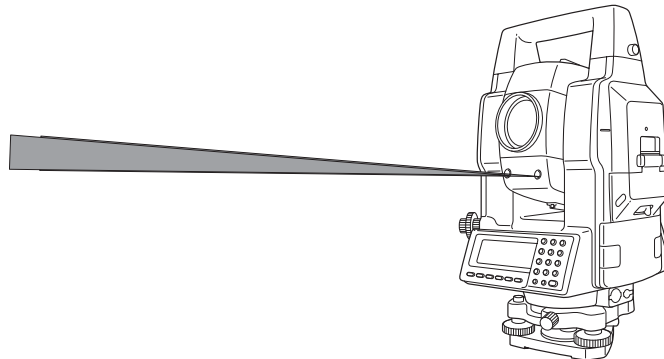

- 1 The function of the Tracking Indicator will be used as a guide to know the status of GTS-820A series from the prism side. This is not a function to determine precise collimating for measuring.
- 1 The quality of its results will depend on the weather conditions and the use's eyesight.
- 1 Sometimes happens difficulty of seeing the tracking indicator because too much bright of the beam for tracking.
- 1 Using Tracking Indicator mode will result shorter in reduced time out of the battery.

## 1.6 Auto Power Off

The Auto Power OFF feature can be set from 1 to 99 minutes. If no keys are pressed within the set time, the Auto Power OFF will automatically turn the instrument OFF in order to save the battery time. See Chapter 8 "PARAMETERS SETTING MODE", for further instructions.

## 1.7 Data Output

When GTS-820A series receives data output command from an external connected device, the measured data will be output by GTS-820A series. Select from the following 2 ways for the output. (For setting, see Chapter 8 "PARAMETERS SETTING MODE" .)

REC-A : The measurement is started and new data is output.

REC-B : The data being displayed is output.

## 1.8 Rotating Method

### 1.8.1 Rotating by H/V Shuttle and H/V Jog

H/V shuttle or H/V jog can be used to rotate the instrument manually. The shuttle movement or displacement is proportional in speed and size of angle desired. A small, slow turn of the shuttle will result in a slow small angle displaced. Likewise, a larger abrupt turn of the shuttle will result in a coarse angle displacement. H/V jog can be used for accurate collimating of the target much like a standard tangent screw.

### 1.8.2 Auto Inversion

Pressing the [F4] key in Star Key mode causes the instrument to reverse and turn the telescope and instrument automatically.

I To stop auto rotating by auto inversion key in case of emergency, press any keys except POWER key.

I During auto rotation, don't disturb the instrument. (Stopping the rotation with a touch of the hand).

Such action may cause trouble or harm to instrument or operator.

See Section 1.5 "Star key (\*key) mode" for further instructions.

### 1.8.3 Rotating automatically to a required Horizontal and Vertical angle

In Standard Measurement Modes, the instrument can be rotated automatically by input a required horizontal and/or vertical angle.

For further instructions, see Section 4.1.5 "Automatic Rotation to a Required Horizontal and Vertical Absolute Angle" .

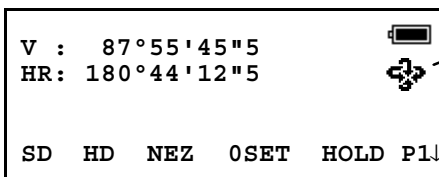

This mark will appear while the instrument is rotating automatically.

## 1.9 Using together with RC-2II Remote Control System

Using together with RC-2II Remote Control System makes it possible to optical communicate between the instrument and remote controller RC-2R11, the prism side. This gives easy operation by one man surveying in applying programs.

Also connecting data collector to remote controller, you can manage communication reciprocally between the instrument and direct to data collector.

### Turn-round function

You can turn the GTS-820A series round to the remote controller RC-2R11 side easily by [Turn-round] key of the remote controller RC-2R11. This function helps to increase one man surveying efficiency.

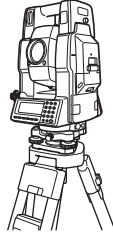

RC-2R11

See to Section 5.7 "External Link" and Chapter 8 "PARAMETERS SETTING MODE" for further information.

- 1 Set the transmit path to "RC".
- 1 Set the transmit channel same as RC-2R11 side.
- 1 To execute transmission, set the remote in Programs mode to [Remote].

## 1.10 Using connecting with Personal Computer (PC)

The auto-tracking function or auto collimating function makes easy remote control of the instrument from PC. The followings are the main communication commands and explanations. How to communicate or more informations of communication command, you can see the interface manual which provided optionally.

Commands		Action of GTS-820A series
<b>Transmit command</b>	Transmit command for measured data	Each measured data will be out put according to the command type.
	Transmit command for tracking mode	The status of Automatic Tracking mode will be out put.
	Transmit command for battery level	The battery level will be out put.
	Transmit command for coordinate of instrument point	Setting coordinate of instrument point will be out put.
	Transmit command for tracking parameter	Each setting tracking parameter of instrument will be out put according to the command type.
<b>Mode setting</b>	Setting of angle measurement	Each selecting mode in horizontal angle or angle measurement can be decided according to the purpose of command.
	Setting of distance measurement	Setting the measurement mode for distance measurement.
	Setting coordinate of instrument point	Setting the coordinate of instrument point.
	Setting the tracking parameter	Setting each tracking parameter according to the command.
	T.I. ON / OFF	ON / OFF of Tracking indicator.
<b>Action</b>	Rotating command	Rotating of setting angle.
	Inversion	Inversion movement.
	Setting tracking mode	Setting from automatic tracking mode to each command mode.



## 2 PREPARATION FOR MEASUREMENT

### 2.1 Power Connection

(unnecessary if on-board Ni-MH battery BT-56Q is used)

See below for connecting the external battery pack.

- 1 **Battery pack BT-3Q**  
Power cord , PC-5 is used.
- 1 **Large capacity battery pack BT-3L**  
Power cord PC-6 is used.
- 1 When using a external battery, the rechargeable battery BT-56Q should be attached  
(The instrument will lack in balance if the internal battery BT-56Q is removed.)

The external battery and the internal battery can be used at the same time. The GTS-820A series will select a battery due to the battery remaining automatically.

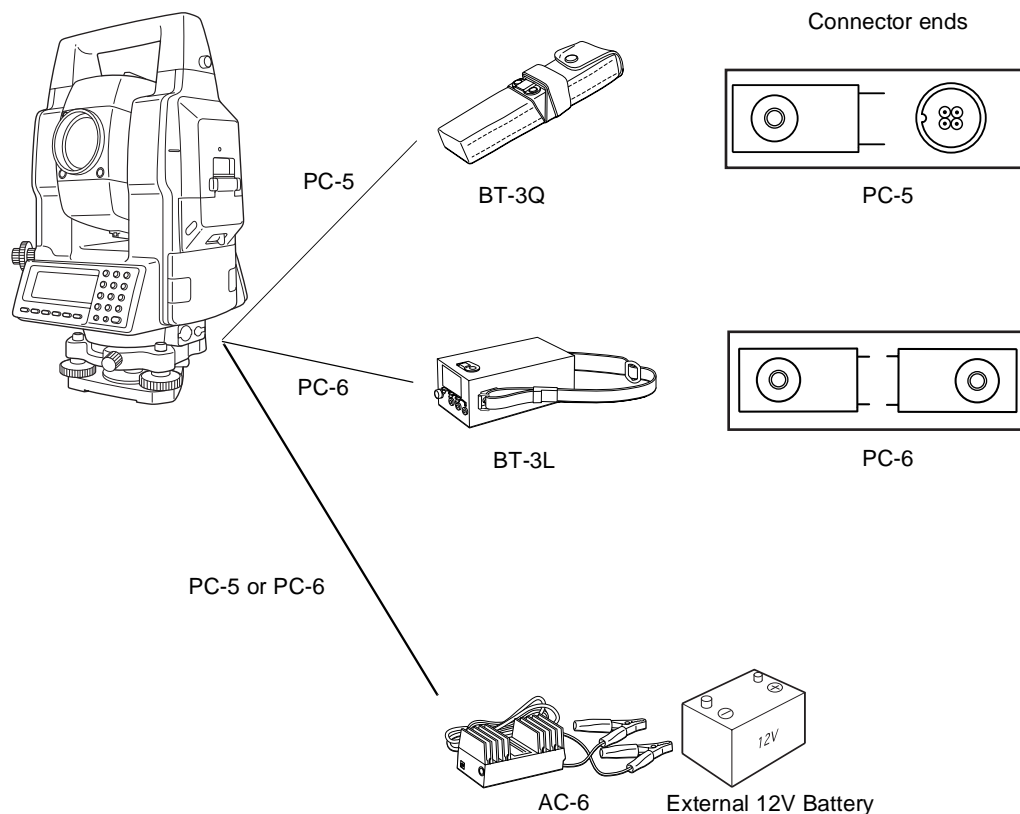

## 2.2 Setting Instrument Up For Measurement

Mount the instrument to the tripod. Level and center the instrument precisely to insure the best performance. Use tripods with a tripod screw of 5/8 in. diameter and 11 threads per inch, such as the Type E TOPCON wide- frame wooden tripod.

### Reference: Leveling and Centering the Instrument

#### 1. Setting up the Tripod

First, extend the extension legs to suitable lengths and tighten the screws on their midsections.

#### 2. Attaching the Instrument on the Tripod Head

Place the instrument carefully on the tripod head and slide the instrument by loosening the tripod screw. If the plumb bob is positioned right over the center of the point, slightly tighten the tripod screw.

#### 3. Roughly Leveling the Instrument by Using the Circular Level

- 1 Turn the leveling screws A and B to move the bubble in the circular level. The bubble is now located on a line perpendicular to a line running through the centers of the two leveling screws being adjusted.

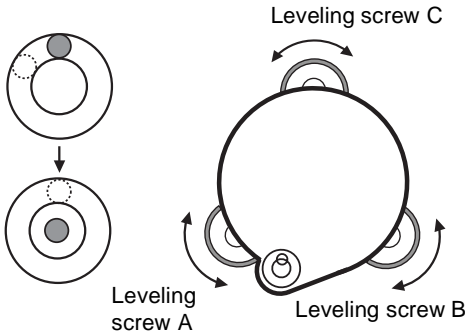

- 2 Turn the leveling screw C to bring the bubble to the center of the circular level.

#### 4. Centering by Using the Plate Level

- 1 Rotate the instrument horizontally by using the Horizontal motion/clamp screw and place the plate level parallel with the line connecting leveling screws A and B, and then bring the bubble to the center of the plate level by turning leveling screws A and B.

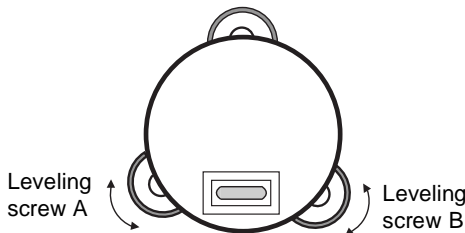

- 2 Rotate the instrument 90° (100g) around its vertical axis and turn the remaining leveling screw or C to center the bubble once more.

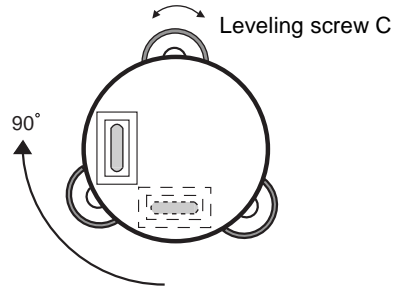

- 3 Repeat the procedures 1 and 2 for each 90° (100g) rotation of the instrument and check whether the bubble is correctly centered for all four points.

#### 5. Centering by Using the Optical Plummet Telescope

Adjust the eyepiece of the optical plummet telescope to your eyesight. Slide the instrument by loosening the tripod screw, place the point on the center mark, and then tighten the tripod screw. Sliding the instrument carefully not to rotate that allows you to get the least dislocation of the bubble.

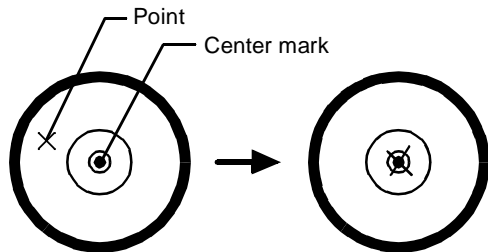

#### 6. Completely Leveling the Instrument

Leveling the instrument precisely in a similar way to 4. Rotate the instrument and check to see that the bubble is in the center of the plate level regardless of telescope direction, then tighten the tripod screw hard.

### 2.3 Power Switch Key ON

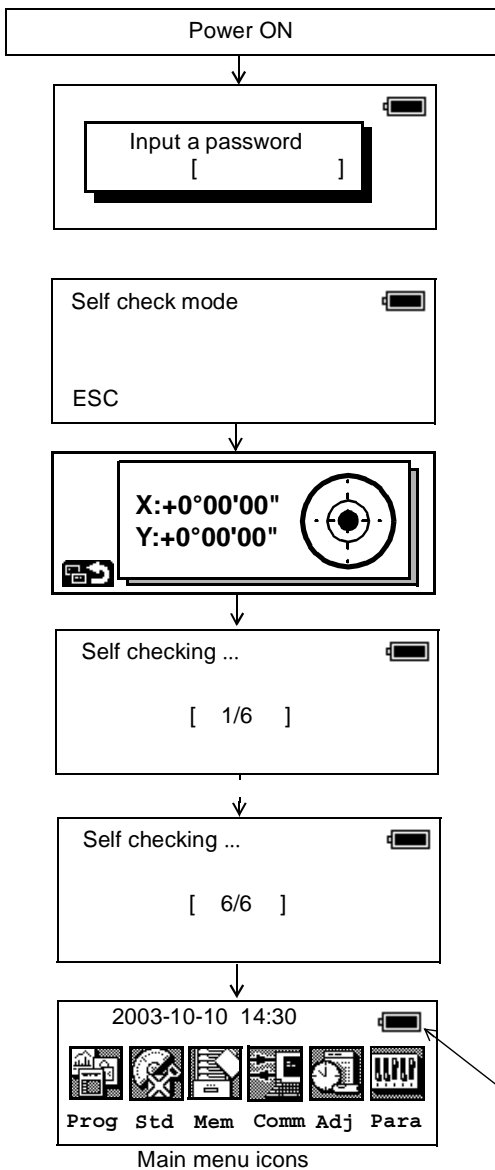

- 1) Confirm the instrument is leveled.
- 2) Turn the power switch ON.
- 3) Type your password.  
Self checking mode will display.

To skip the self checking, press [F1](ESC) key.

Level the instrument by turning the leveling screws.  
When the leveling is within  $\pm 30''$  and stable, the self checking will start.

The instrument will turn automatically and the tilt sensor offset value will be measured and memorized.

After checking, the main menu icons will be shown.

Battery Power Remaining Display

Main menu icons

#### 1 Self checking option

The self checking function is to check internal communication and tilt sensor offset value. When ambient temperature is changed or the instrument is not balanced by its internal battery is attached or detached, the self checking is recommended.

#### 1 Password option

Setting a password (Maximum 10 digits number) and activating ON of password option can be helpful to avoid miss operation by unauthorized operator. Setting password option is necessary to use this function.

To set password option, see Chapter 8 "PARAMETERS SETTING MODE" .

#### 1 Choosing the first mode when turning on the instrument

You can choose the first mode from the following modes when turning on the instrument.

1. Main Menu
2. Standard Measurement Mode
3. External Link

See Chapter 8 "PARAMETERS SETTING MODE" .

#### 1 ON/OFF of a self check function can also be chosen.

See Chapter 8 "PARAMETERS SETTING MODE" .

- 1 Confirm the battery power remaining on the display. Replace with charged battery or charge when battery level is low. Refer to Section 2.4 "Battery Level Indicator" .

## 2.4 Battery Level Indicator

The battery power indicator shows the level of battery strength.

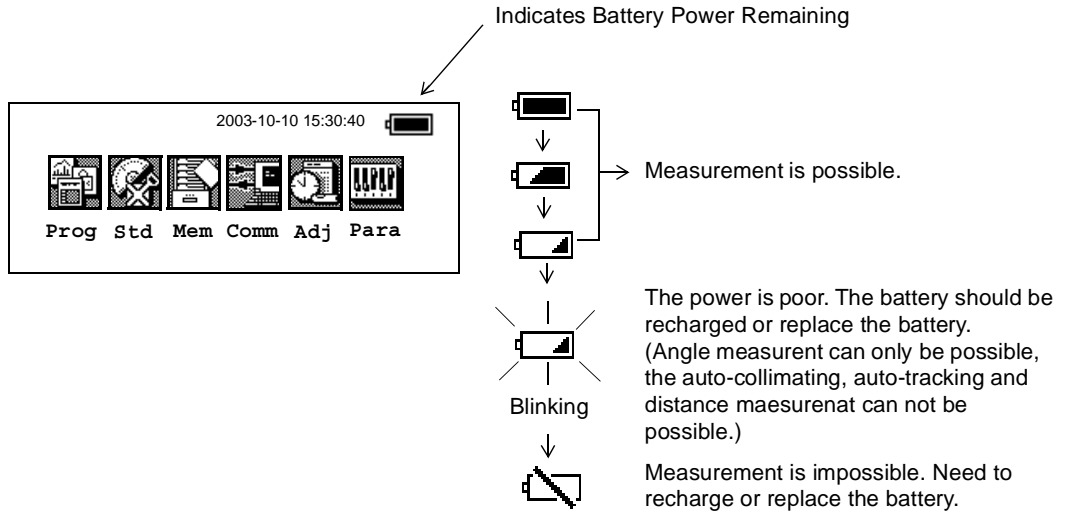

\* Battery power remaining display is omitted in this manual.

### Note:

- 1) The battery operating time will vary depending on the environmental conditions, such as ambient temperature, charging time, and the number of times charging and discharging the battery.
- 2) In low temperature (especially while the heater of display is working), the battery operating time will shorten to one-half of normal temperature use.
- 3) The indicator for battery power remaining shows the power level during each measurement mode. The condition indicated for the battery power remaining in the angle measurement mode may not be adequate to measure a distance. Changing from angle mode to distance mode during a poor battery condition may cause the EDM not to measure a distance. We recommend that you check the battery condition before going into the field.
- 4) Also note, when changing from one measurement mode to another, the battery indicator may not show a decrease or an increase immediately. The battery indicator system was designed to show the general condition for the battery strength. It does not respond instantly.
- 5) For more information on battery usage, refer to Chapter 13 "POWER SOURCE AND CHARGING".

## 2.5 Main Menu Icons

The main menu icons are as follows.

Select the menu by pressing soft keys ([F1]~[F6]).

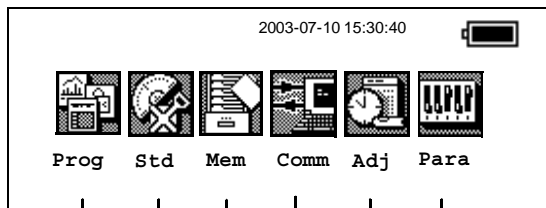

### PARAMETERS SETTING MODES

The PARAMETERS SETTING MODES are stored in memory once the instrument is OFF. (See Chapter 8 "PARAMETERS SETTING MODE".)

### ADJUSTMENT MODES

Used for checking and adjustment.

- 1 Systematic errors adjustment for compensation.
  - 1 Show compensation values of systematic errors of instrument
  - 1 Set Date & Time
  - 1 Set instrument constant value
  - 1 Reference frequency of EDM
  - 1 Optic Axis for Auto-tracking
- (See Chapter 9 "CHECK AND ADJUSTMENT".)

### COMMUNICATION MODES

- 1 Set communication with external instrument
  - 1 Input/Output a data file
  - 1 Load application program.
- (See Chapter 7 "COMMUNICATION MODES".)

### MEMORY MANAGE MODES

- 1 Display memory status
  - 1 Protect/Eras/Rename/Copy Files,
  - 1 Initialize a card or internal memory.
- (See Chapter 6 "MEMORY MANAGE MODES" .)

### STANDARD MEASUREMENT MODES

- 1 Angle measurement
  - 1 Distance measurement
  - 1 Coordinate measurement
- (See Chapter 4 "STANDARD MEASUREMENT MODE" .)

### PROGRAM MODES ( APPLICATION MEASUREMENT)

- 1 Set a direction angle for horizontal orientation
  - 1 Retain Coordinate (STORE-NEZ)
  - 1 Remote elevation measurement
  - 1 Missing line measurement
  - 1 Line measurement
  - 1 External link
  - 1 Off set measurement
- (See Chapter 5 "PROGRAM MODES" .)

## 2.6 Vertical and Horizontal Angle Tilt Correction

When the tilt sensors are activated, automatic correction of vertical and horizontal angle for mislevelment is displayed.

To ensure a precise angle measurement, tilt sensors must be turned on. The display can also be used to fine level the instrument. If the (TILT OVER) display appears the instrument is out of automatic compensation range and must be leveled manually.

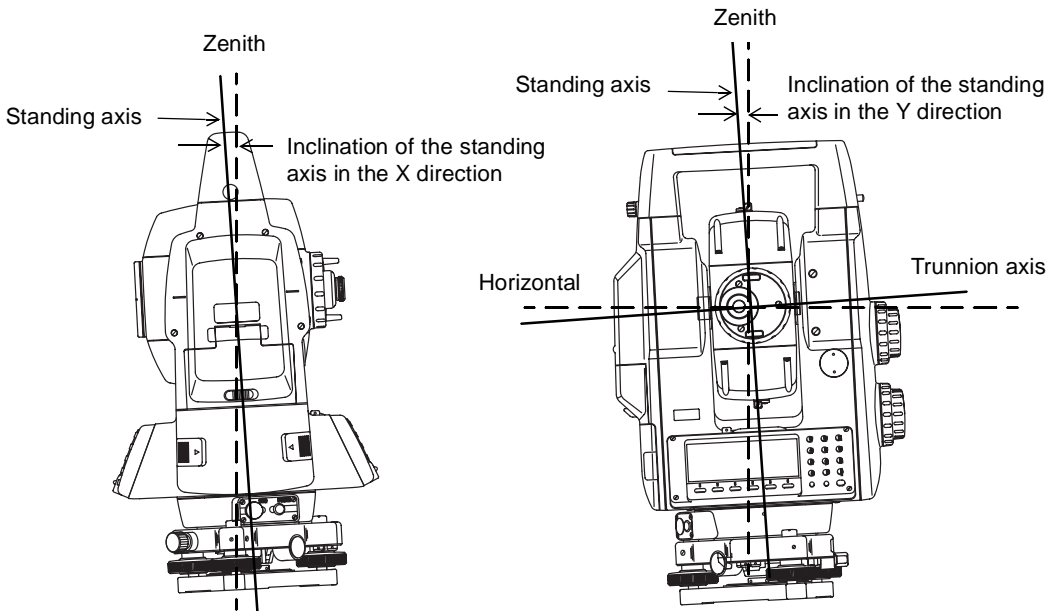

- 1 GTS-820A series compensates both the vertical angle and the horizontal angle readings due to inclination of the standing axis in the X and Y directions.
- 1 For more information about dual axis compensation, see Chapter "APPENDIX" "Dual Axis Compensation".

When the instrument tilted over correction range.

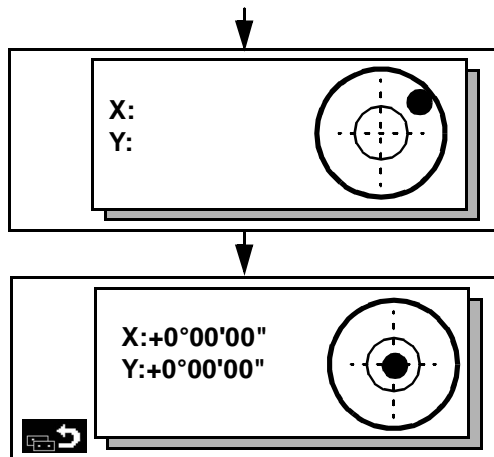

Rotate the leveling screws and level the instrument.

After leveling (when each axis is within  $\pm 1'30''$ ), the display returns to the previous mode automatically.

X,Y tilt correction range : within  $\pm 4'$

- 1 The display of Vertical or Horizontal angle is unstable when instrument is on an unstable stage or a windy day. You can turn off the auto tilt correction function of V/H angle in this case. To set TILT correction mode ON/OFF, refer to next page or Chapter 8 "PARAMETERS SETTING MODE".

1 **Setting Tilt Correction by Soft Key**

Enable you to select tilt ON/OFF function on page 2.

The setting performed here will be memorized after powering OFF.

**[Example] Setting X,Y Tilt ON**

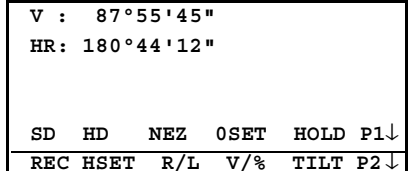
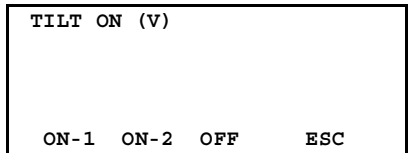
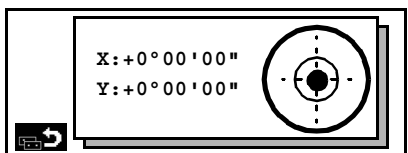
Operating procedure	Option	Display
<p>1 Press [F6] key to get the function page 2.</p>		
<p>2 Press [F5](TILT) key. Current setting is displayed. *1</p>	[F5]	
<p>3 Press [F2](ON-2) key. The display shows tilt correction value.</p>	[F2]	
<p>4 Press [F1] key. The display returns previous mode.</p>	[F1]	

\*1) Pressing [F6](ESC) key, the display returns previous mode.  
 1 The tilt sensor setting will be stored in memory when the instrument is turned OFF.  
 The tilt sensor option can also be changed in the Parameter Setting Modes. When you change the tilt sensor option in the angle measurement mode, it will change in the Parameter Setting Modes and visa verse.

**2.7 Compensation of Systematic Error of Instrument**

- 1) Error of vertical axis (X,Y tilt sensor offset)
- 2) Collimation error
- 3) Error of vertical angle 0 datum
- 4) Error of horizontal axis

The above mentioned errors can be compensated by software, which calculated internally according to each compensation value.

Also these errors can be compensated by software collimating one side of the telescope that is carried out to delete the error by turning in normal and reverse both sides of telescope so far.

- 1 To adjust or reset the above compensation value, see Chapter 9 'CHECK AND ADJUSTMENT' .
- 1 Enable you to stop this function, see Chapter 8 "PARAMETERS SETTING MODE" or Chapter 9 "CHECK AND ADJUSTMENT" .





## 2.10 Memory Card

### How to insert a memory card

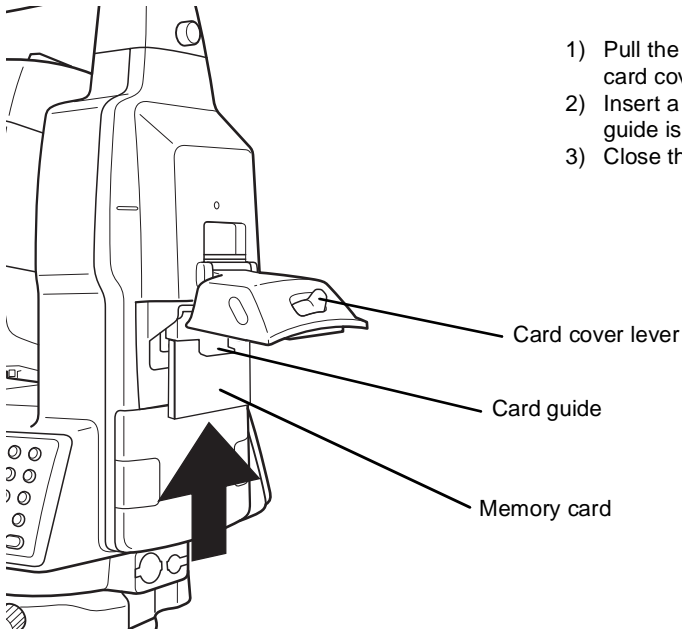

### How to extract a memory card

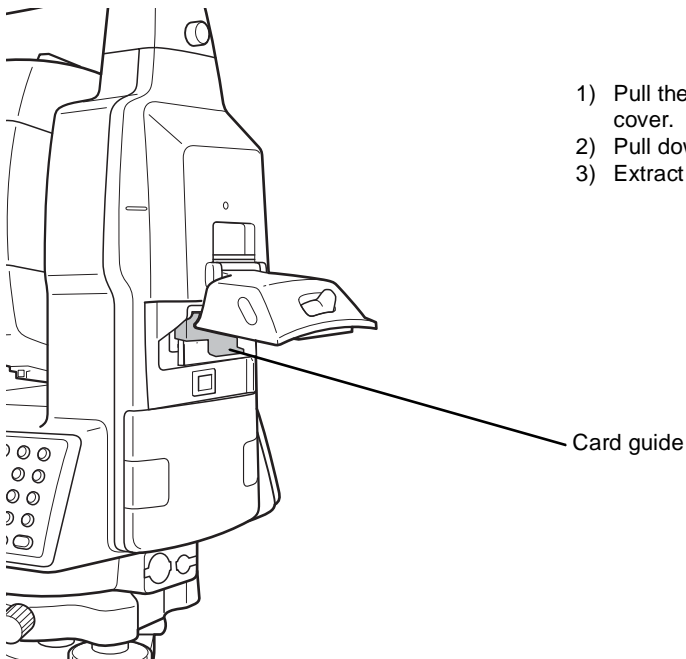

## 2.11 Inclination of Prism and Measuring Error

For the best results, aim or point prisms in the direction of the GTS-820A series so that maximum signal can be returned to the instrument. Sighting prism obliquely because of inclined settings, may result in measuring errors. These errors will be proportional to the misalignment as showing in following graphs. The more misalignment of the prism, the more error in measurement.

Measured data can be different according to the prism constant value. This can occur when a prism is moving. Pin-pole prism set L1 (for one-person surveying) and pin-pole prism holder L1 (for fixed point observation) are designed to minimize measuring error in such case. Make the best use of them. In case you are forced to use the normal prism in inclined state because there is no other way possible, we recommend to use switching holder, prism constant value (0 or 30mm), and set to 30mm (Compensation value of -30mm).

**Prism constant value : 0mm**

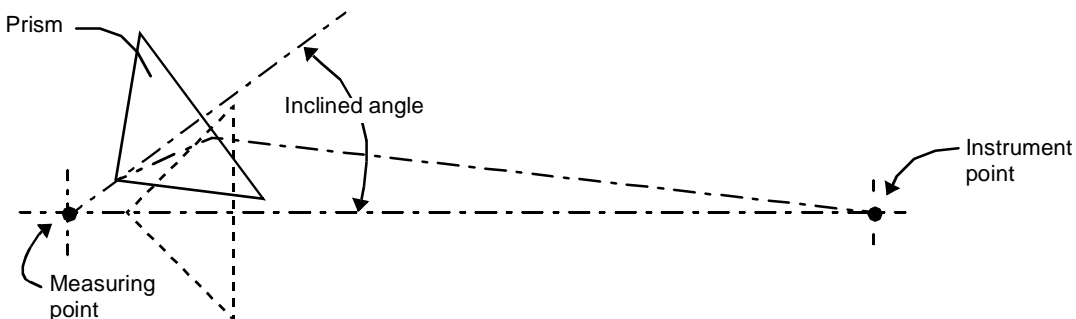

**Prism constant value : 30mm**

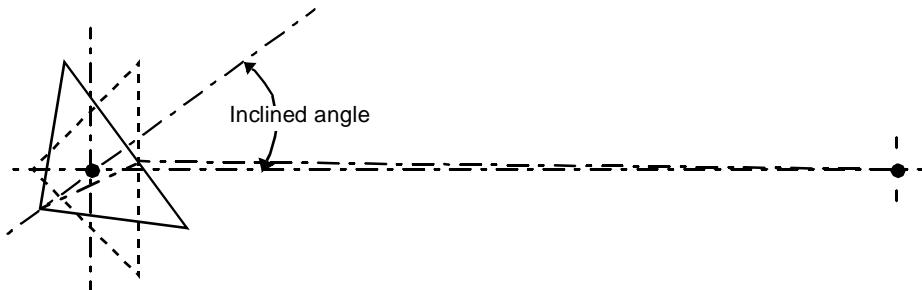

1 Prism type-2 (Normal prism)

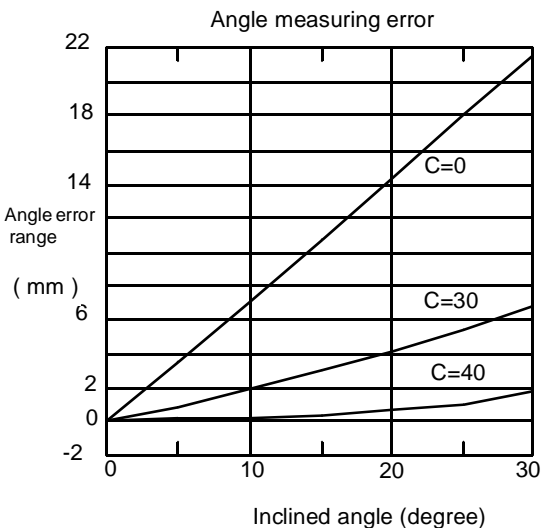
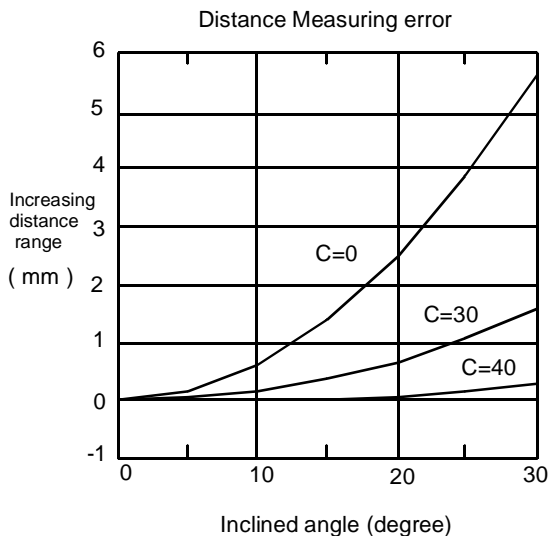

1 Prism type - 3 or 5 (Prism unit A2/A3)

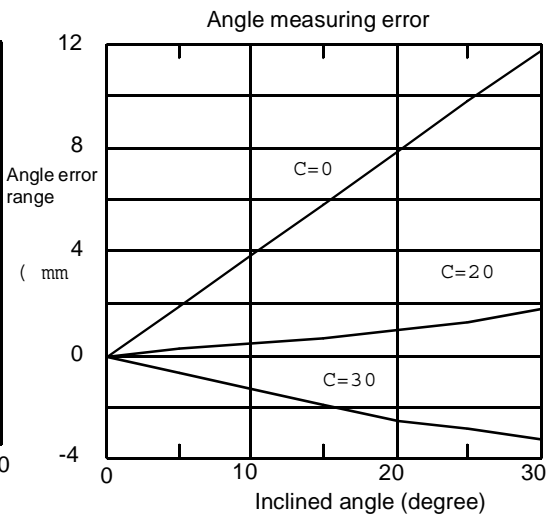
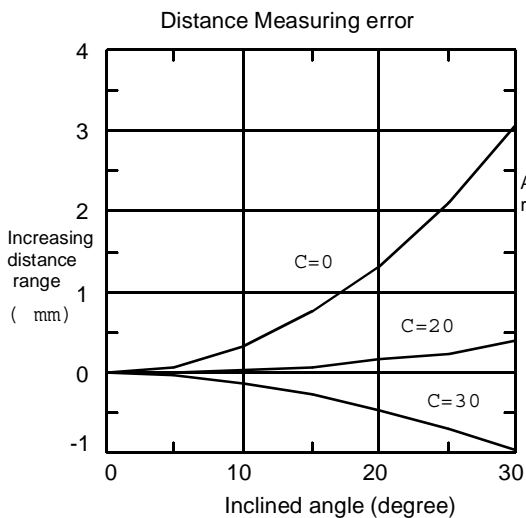

**(Example)**

In case Prism constant value (C) = 0mm, Prism inclination = 20°, Measuring distance = 100m by Prism type-2 :

1 Distance error is :

From the graph prism type-2, the distance error shows in increasing range quantity 2.5mm along curved line of C=0 when prism inclination is 20°.

1 Angle error is :

From the graph prism type-2, along curved line of C=0 with prism inclination of 20°, find angle error quantity (14.2mm) and calculate angle error by the following formula.

$$\begin{aligned} \text{Angle error} &= \tan^{-1} \left( \frac{\text{Angle error range}}{\text{Measuring distance}} \right) \\ &= \tan^{-1} \left( \frac{14.2}{100 \times 10^3} \right) \\ &= 29'' \end{aligned}$$

### 3 AUTOMATIC TRACKING / AUTOMATIC COLLIMATION







 <b>WARNING</b>
<p>1 Cause eye injury or blindness. Do not stare into beam.</p>

 <b>CAUTION</b>
<p>1 Let the laser beam reach the aimed object or the target without anybody else in the laser beam path. In case you operate laser beam open, avoid radiating laser beam to the height of man's head. It is quite possible for the beam to enter into one's eyes, and it is possible to lose visual sight temporarily, and lose one's caution and awareness of other dangers - avoid glaring beam.</p>

#### 3.1 Automatic Tracking

Measuring the moving target in automatic tracking mode.

- 1 The Coarse (10mm) mode is used for the moving target.
- 1 Use a keyboard on the eyepiece side. When the keyboard on the opposition side is used an error will be displayed to protect a worker from the radiation of the laser.

Operating procedure	Option	Display
<p><b>1</b> Manually collimate the target prism using V/H jog/shuttle.</p>		<div style="border: 1px solid black; padding: 5px; margin-bottom: 5px;"> <p>V : 87°55'45" HR: 180°44'12"</p> <p>SD HD NEZ OSET HOLD P1↓</p> </div>
<p><b>2</b> Press the star [*] key to show the star key options.</p>	[*]	<div style="border: 1px solid black; padding: 5px; margin-bottom: 5px;"> <p>2003-10-10 14:30:40</p> <p>       </p> </div>
<p><b>3</b> Press the [F1] key. The mode will be automatic tracking mode. The instrument searches the prism and tracks automatically.</p>	[F1]	<div style="border: 1px solid black; padding: 5px;"> <p>V : 87°55'45" HR: 180°44'12" </p> <p>SD HD NEZ OSET HOLD P1↓</p> </div>

- 4 Choose measuring modes by pressing the soft keys.  
 Measuring starts.  
 Sample: Horizontal distance measuring

[F2]

V :	90°10'20"		→(((⊗)))
HR:	120°30'40"	PSM	0.0
HD:	<	PPM	0.0
VD:		(m)	*c.R
MEAS	MODE	VH	SD NEZ P1↓

- 1 If the target prism is lost during auto tracking status, the instrument will automatically change to Waiting status and symbol mark will be switched. If the target is found during Waiting status, tracking resumes, and if not, status changes to Searching status. When the target prism is found, tracking will resume.

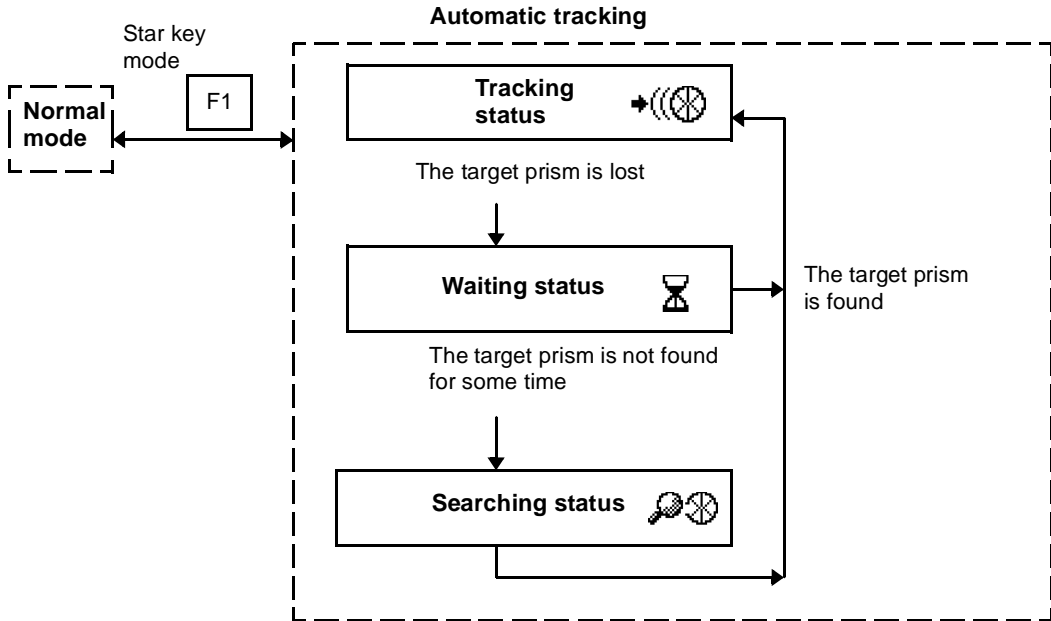

- 1 The following symbol marks are indicated at the right side of the display.  
 In all these status, laser beam is emitting.

- (((⊗))) Tracking status
- ⌚ Waiting status
- (((⊗))) Searching status

- 1 Auto tracking status sometimes can be unstable for a few seconds after the optical path is disturbed.  
 1 If the center of reticle and the center of the prism is not coincided, you should adjust optical axis for auto-tracking, refer to chapter 9"Check and adjustment".  
 1 In the not suitable operating condition in such the atmospheric condition is not good by the heat shimmer, or other bad weather condition, in the long distance of the auto-tracking limit, can be happened not certain tracking or not tracking at the center of the prism.



### 3.3 Range of Laser for Auto-tracking and Auto-collimating

The range of laser at the long distance is within  $\pm 30'$  as shown in following. So you had better collimate the prism so that the prism may be located within this range of laser in the first step. As for it, rapid automatic collimating and automatic tracking becomes possible. If the target prism is out of this range, time for searching mode will be necessary.

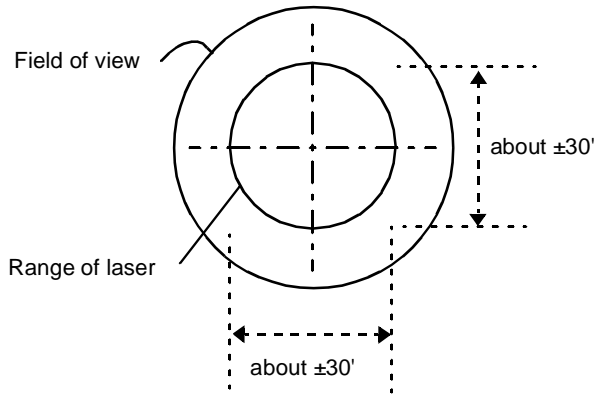

The range of the laser beam for auto-tracking in a short distance is same as a telescopic field of view. Therefore, quick starting of auto-tracking and auto-collimating are possible if the prism is contained in the telescopic field of view.

### 3.4 Setting Parameters for Auto-Tracking

A proper setting for each parameter are necessary for custom use.  
The setting of the parameters can be done in the star key mode.

#### 3.4.1 Setting Items

Items	Selecting item	Contents
SEARCH PATTERN	PATTERN 1	The search range is the area to searched for the prism by rotating the telescope and body in searching.
	PATTERN 2	
SEARCH RANGE	V:0° to 90° H:0° to180°	The search range is the area to searched for the prism by rotating the telescope and body in searching. The SEARCH range is decided from the point where the prism lost, and the values will be set to plus and minus directions in horizontal and vertical. Also it is enable to set each search pattern separately.
WAIT TIME	0:00 to1:00:00 (1sec. step)	The time the prism is lost before GTS-820A series starts the searching. If the mode is set to [HOLD], mode will not change to searching.
	HOLD	
TRACKING SPEED	SURVEY	Select your purpose.
	MACHINE CONTROL	
REFLECTOR TYPE	PRISM	The type of the reflector can be selected.
	REFLECTOR TAPE	
PREDICTION CTRL TIME	0.5sec./ 1sec. / 2sec. /3sec. / 4sec / 5sec.	After the instrument loses a prism, the time (prediction operation time) for the instrument to continue moving operation can be set up.

#### 1) Search Patterns

The search pattern is the rotating method of telescope and instrument to find the target prism in search mode. Search pattern includes the following 2 ways that can be selected.

<b>PATTERN 1</b>	This pattern can be selected to search the prism at the point where the prism is lost. Instrument searches in up down direction gradually from the point where the prism is lost. The searching is arranged to 2 times until the prism is found. The auto tracking mode changes to manual mode when the reflector could not found out within 2 times searching, and returns to the point where the reflector is lost.
<b>PATTERN 2</b>	This pattern can be selected to search for the prism. The search pattern tries to locate the prism in a very short time. The searching is arranged to 2 times until the reflector is found. The auto tracking mode changes to manual mode when the reflector could not found out within 2 times searching, and returns to the point where the reflector is lost.

- 1) Things like heat haze might interfere with the tracking system in the long distance, near limit of auto tracking range, in search mode.
- 2) Reaction by rotating of instrument in search mode is serious. Be sure of each connection part of the tribrach or tripod are firmly.

#### 2) Search Range

The search range is the area to searched for the prism by rotating the telescope and body in Searching. The Search range is decided from the point where the prism lost, and the values will be set to plus and minus directions in horizontal and vertical.

Select search pattern first, and set the search range to the selected search pattern. Also it is enable to set each search pattern separately.



[Example] SEARCH RANGE : 10° in horizontal, 5° in vertical

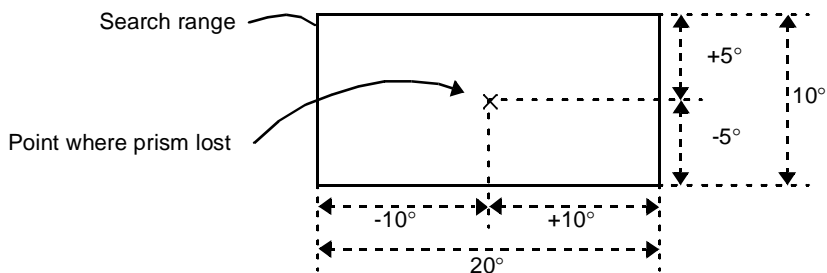

Setting Search range requires consideration. The items to think about: optical path interrupted by other objects; collimated point from GTS-820A series to prism is shifted after Turning and Searching Command; possible other prisms, targets, or other objects to interfere with tracking the desired prism; and many other examples all play a role in determining the search range.

Note: This search range is only for auto-tracking function. The search range of auto-collimating is fixed as  $\pm 5^\circ$  in both directions horizontal and vertical.

### 3) Wait Time

The time the prism is lost before GTS-820A series starts the searching. Setting time is 1second step maximum 60 minutes.

If the mode is set to [HOLD], mode will not change to searching.

### 4) Tracking Speed

Choose the mode of "Survey" or "Machine Control" according to the purpose of measurement.

<b>SURVEY</b>	<ul style="list-style-type: none"> <li>  In case requiring auto aiming in high accuracy to the prism which is still.</li> <li>  Suitable for fixed point observation, management of landslides, surveying displacement of dam.</li> <li>  When beginning auto-tracking, the instrument needs to collimate stable prism.</li> </ul>
<b>MACHINE CONTROL</b>	<ul style="list-style-type: none"> <li>  Suitable for controlling of construction machinery or real time surveying of variety traveling objects.</li> <li>  When beginning auto-tracking, the instrument can track a prism, even if the prism is moving.</li> </ul>

Note: If the Machine Control mode is chosen, the GTS-820A may incorrect-track the headlight of a car etc. temporarily.

### 5) Reflector type

You can choose a reflector type according to reflective objects such as Prism-2 or reflector tape. This setting will reduce incorrect tracking.

### 6) Prediction operating time



After the instrument loses a prism, the time (prediction operation time) for the instrument to continue moving operation can be set up.

During auto tracking operation, when auto tracking axis between the instrument and a prism is intercepted by a tree etc., the moving is continued supposing a motion (prediction) of the prism till then. It is effective in auto tracking operation after the prism is intercepted with the obstacle by this function.

When an obstacle is large, the prediction operation time should be set up long. Moreover, when you want to terminate auto tracking operation immediately at the point which missed the prism, and to be changed into a search state. Prediction operation time should be set up short.

### 3.4.2 How to set the parameters

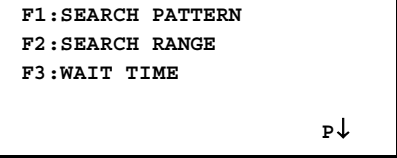
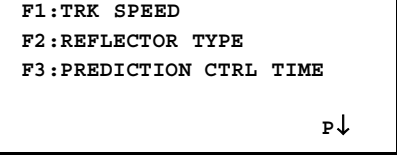
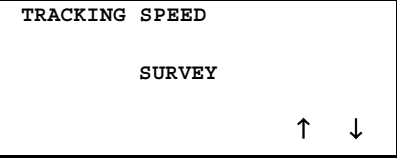
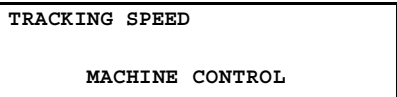
Sample setting: Set TRACKING SPEED to [MACHINE CONTROL]

Operating procedure	Option	Display
<p><b>1</b> Press the star [*] key to be in star key mode.</p>	<p>[*]</p>	
<p><b>2</b> Press the [F3] key to select the setting parameters for auto-tracking.</p>	<p>[F3]</p>	
<p><b>3</b> Press the [F6](P↓) key to get the menu on page 2.</p>	<p>[F6]</p>	
<p><b>4</b> Press the [F1](TRK SPEED) key.</p>	<p>[F1]</p>	
<p><b>5</b> Press the [F6](↓) key to select [MACHINE CONTROL].</p>	<p>[F6]</p>	
<p><b>6</b> Press the [ENT] key to decide.</p>	<p>[ENT]</p>	

# 4 STANDARD MEASUREMENT MODE

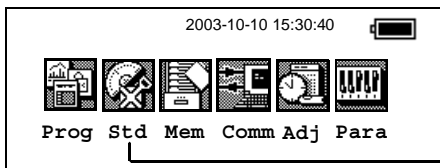

[Press [F2] key.]

**STANDARD MEASUREMENT MODE**  
 Angle measurement, Distance measurement,  
 Coordinate measurement .

## 4.1 Angle Measurement

### 4.1.1 Measuring Horizontal Angle Right and Vertical Angle

Make sure the mode is in Angle measurement.

Operating procedure	Operation	Display
<b>1</b> Collimate the 1st target (A).	Collimate A	V : 87°55'45" HR: 180°44'12"  SD HD NEZ OSET HOLD P1↓
<b>2</b> Set horizontal angle of target A at 0° 00' 00". Press [F4](0 set) key and [F6](SET) key.	[F4]	H-0SET HR: 00°00'00"  ESC SET
	[F6]	V : 87°55'45" HR: 00°00'00"  SD HD NEZ OSET HOLD P1↓
<b>3</b> Collimate the 2nd target (B). The required H/V angle to target B will be displayed.	Collimate B	V : 87°55'45" HR: 123°45'50"  SD HD NEZ OSET HOLD P1↓

### Reference : How to Collimate

- 1 Point the telescope toward the light. Turn the diopter ring and adjust the diopter so that the cross hairs are clearly observed.  
(Turn the diopter ring toward you first and then backward to focus.)
- 2 Aim the target at the peak of the triangle mark of the sighting collimator. Allow a certain space between the sighting collimator and yourself for collimating.
- 3 Focus the target with the focusing knob.

\*If parallax is created between the cross hairs and the target when viewing vertically or horizontally while looking into the telescope, focusing is incorrect or diopter adjustment is poor.

This adversely affects precision in measurement or survey. Eliminate the parallax by carefully focusing and using diopter adjustment.

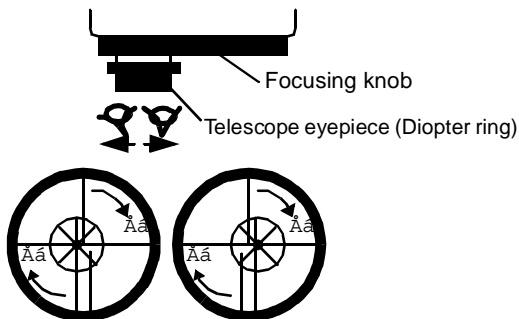

### 4.1.2 Switching Horizontal Angle Right/Left

Make sure the mode is Angle measurement.

Operating procedure	Operation	Display
<p><b>1</b> Press [F6](↓)key to get the function as on page 2.</p>		<pre>V : 87°55'45" HR: 120°30'40"  SD  HD  NEZ  OSET  HOLD P1↓ TURN HSET R/L  V/%  TILT P2↓</pre>
<p><b>2</b> Press [F3](R/L) key. The mode Horizontal angle Right (HR) switches to (HL) mode.</p>	[F3]	<pre>V : 87°55'45" HL: 239°29'15"      PSM  0.0                         PPM  0.0                         (m) *F.R TURN HSET R/L  V/%  TILT P2↓</pre>
<p><b>3</b> Measure as HR mode.</p>		
<p>1 Every time pressing [F2](R/L) key is pressed, HR/HL mode switches. 1 HR/HL switching can be turned OFF. Refer to Chapter 8 "PARAMETERS SETTING MODE" .</p>		

### 4.1.3 Measuring from the Required Horizontal Angle

#### 1) Setting by Holding the Angle

Make sure the mode is angle measurement.

Operating procedure	Operation	Display
<p><b>1</b> Set the required horizontal angle, using Horizontal jog/shuttle.</p>	Display angle	<pre>V : 90°10'20" HR: 70°20'30"  SD  HD  NEZ  OSET  HOLD P1↓</pre>
<p><b>2</b> Press [F5](HOLD) key.</p>	[F5]	<pre>Holding HR: 70°20'30"  ESC                                REL</pre>
<p><b>3</b> Collimate the target.*1)</p>	Collimate	
<p><b>4</b> Press [F6](REL) key to finish holding the horizontal angle. The display turns back to normal angle measurement mode.</p>	[F6]	<pre>V : 90°10'20" HR: 70°20'30"  SD  HD  NEZ  OSET  HOLD P1↓</pre>
<p>*1)To return to the previous mode, press [F1](ESC) key.</p>		

**2) Setting a Horizontal Angle from the Keys**

Make sure the mode is Angle measurement.

Operating procedure	Operation	Display
<b>1</b> Collimate the target.	Collimate	V : 90°10'20" HR: 120°30'40"
<b>2</b> Press [F6](↓) key to get the function as on page 2, and press [F2](HSET) key.	[F6]	SD HD NEZ OSET HOLD P1↓ TURN HSET R/L V/% TILT P2↓
	[F2]	H-SET HR: _
<b>3</b> Input the required horizontal angle. *1) For example:70°20'30"	Input value	H-SET HR:70.203
		EXIT BS
<b>4</b> Press [ENT] key. *2) When completed, normal measuring from the required Horizontal angle is possible.	[ENT]	V : 90°10'20" HR: 70°20'30"
		SD HD NEZ OSET HOLD P1↓
<p>*1)To revise wrong value, move cursor with [F6](BS) key, or input from the beginning by [F1](EXIT) key to correct value.</p> <p>*2)With wrong input value (for example 70'), setting will not be completed. Input again from step <b>3</b>.</p>		

**4.1.4 Vertical Angle Percent Grade(%) Mode**

Make sure the mode is Angle measurement.

Operating procedure	Operation	Display
<b>1</b> Press [F6](↓) key to get the function as on page 2.		V : 90°10'20" HR: 120°30'40"
	[F6]	SD HD NEZ OSET HOLD P1↓ TURN HSET R/L V/% TILT P2↓
<b>2</b> Press [F4](V/%) key. *1)	[F4]	V%: -0.30 % HR: 120°30'40"
		TURN HSET R/L V/% TILT P2↓
<p>*1) Every time pressing the [F4](V/%) key, the display mode switches.</p>		

### 4.1.5 Automatic Rotation to a Required Horizontal and Vertical Absolute Angle

The GTS-820A series can be rotated to a required horizontal and vertical absolute angle by direct key input.

Example: Both vertical and horizontal angle

Operating procedure	Operation	Display
<p><b>1</b> Press the [F6](↓) key to display the second soft key page.</p>	<p>[F6]</p>	<pre>V : 87°55'45" HR: 120°30'40"  SD HD NEZ 0SET HOLD P1↓ TURN HSET R/L V/% TILT P2↓</pre>
<p><b>2</b> Press the [F1](TURN) key.</p>	<p>[F1]</p>	<pre>TURN(Absolute) F1. V angle F2. H angle F3. V/H angle</pre>
<p><b>3</b> Press the [F3] key.</p>	<p>[F3]</p>	<pre>TURN(Absolute) V : _____ HR: _____  EXIT BS</pre>
<p><b>4</b> Input the vertical angle to be rotated and press [ENT] key. *1) For example : 93°10'40"</p> <p><b>5</b> Input the horizontal angle to be rotated, and press [ENT] key. For example : 160°20'10"</p> <p>The instrument will start to rotate. *2) When the instrument has finished rotating *3), the instrument will return to the previous mode.</p>	<p>V angle [ENT] H angle [ENT]</p>	<pre>TURN(Absolute) V : 93°10'10" HR: 160°20'10"  &lt;Rotating...&gt;</pre>
<p>*1) Setting range for rotation is ;  <math>0^{\circ}00'00'' \leq HR \leq +359^{\circ}59'59''</math>  <math>0^{\circ}00'00'' \leq V \leq +359^{\circ}59'59''</math></p> <p>*2) Press any key except power key to stop rotating in emergency during operation.</p> <p>*3) You can select a accuracy of the actual stopping angular positions. Refer to Chapter 8 "PARAMETERS SETTING MODE".</p>		



### 4.2.4 Distance Measurement (Single/N-times Measurement)

When presetting the number of times, the instrument measures the distance as the setting times and the average distance will be displayed.

When presetting the number of times as 1, it does not display the average distance, because of single measurement. It has been set at single measurement at factory.

#### 1)Setting the number of times

Confirm the angle measurement mode.

Operating procedure	Operation	Display
<b>1</b> Press [F1](SD) or [F2](HD) key.  <b>2</b> Press [F6](↓) key to get the function page as 2.  <b>3</b> Press [F3](MEAN) key.  <b>4</b> Input the setting the number of times, and press [ENT] key. *1) [Example] 4 times N-times measurement starts.		V : 90°10'20" HR: 120°30'40"  SD HD NEZ 0SET HOLD P1↓
	[F2]	V : 90°10'20" HR: 120°30'40" PSM 0.0 HD: PPM 0.0 VD: (m) F.R MEAS MODE VH SD NEZ P1↓ REC SO MEAN m/ft P2↓
	[F6]	Average times  N:0  EXIT BS
	[F3]	V : 90°10'20" HR: 120°30'40" PSM 0.0 HD: < PPM 0.0 VD: (m) *F.N REC SO MEAN m/ft P2↓
	[F4][ENT]	

#### 2)Measuring Method

Confirm the angle measurement mode.

Operating procedure	Operation	Display
<b>1</b> Collimate the center of the prism.  <b>2</b> Select the measurement mode by pressing [F1](SD) or [F2](HD) key. Example: Horizontal distance N-times measurement starts.	Collimate	V : 90°10'20" HR: 120°30'40"  SD HD NEZ 0SET HOLD P1↓
	[F2]	V : 90°10'20" HR: 120°30'40" PSM 0.0 HD: PPM 0.0 VD: (m) F.N MEAS MODE VH SD NEZ P1↓



The average value is displayed following with buzzer sound and “\*” mark disappears.

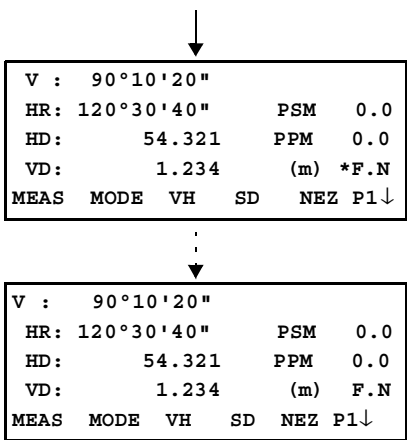

- 1 Press [F1](MEAS) key for re-measuring after the measurement in held.
- 1 To return to the continuous measuring , press [F1](MEAS) key twice.
- 1 To return to the angle measuring mode , press [F3](VH) key.

### 4.2.5 Fine / Coarse Measuring Mode

- Fine mode : This is a normal distance measuring mode.  
 Measurement time 0.2mm mode : approx.2.8 seconds  
 1 mm mode : approx.1.2 seconds  
 The unit to be displayed is 0.2mm or 1mm. (0.001ft or 0.005ft)
  
- Coarse mode (1mm) : This mode measures in shorter time than in fine mode.  
 Use this mode for the objects which may be slightly unstable.  
 Measurement time : approx. 0.7 seconds  
 The unit to be displayed is 1mm. (0.005ft)
  
- Coarse mode (10mm) : This mode measures in shorter time than in coarse(1mm) mode.  
 Use this mode for stake out measurement. It is very useful when tailing the moving object or carrying out stake-out work.  
 Measurement time : approx. 0.4 seconds  
 The unit to be displayed is 10mm. (0.02ft)

Operating procedure	Operation	Display
<p><b>1</b> Collimate the center of prism.</p> <p><b>2</b> Select the measurement mode by pressing [F1](SD) or [F2](HD) key.                      Example: Horizontal distance                      Measuring starts.</p> <p><b>3</b> Press [F2](MODE) key, the mode changes to Coarse mode.                      Press [F2](MODE) key again, the mode changes to Tracking mode. *1)</p>	<p>Collimate</p> <p>[F2]</p> <p>[F2] [F2]</p>	<div style="border: 1px solid black; padding: 5px; margin-bottom: 5px;">                     V: 90°10'20"                      HR: 120°30'40"                        SD HD NEZ 0SET HOLD P1↓                 </div> <div style="border: 1px solid black; padding: 5px; margin-bottom: 5px;">                     V : 90°10'20"                      HR: 120°30'40" PSM 0.0                      HD: &lt; PPM 0.0                      VD: (m) *F.R                      MEAS MODE VH SD NEZ P1↓                 </div> <div style="border: 1px solid black; padding: 5px;">                     V : 90°10'20"                      HR: 120°30'40" PSM 0.0                      HD: PPM 0.0                      VD: (m) c.R                      MEAS MODE VH SD NEZ P1↓                 </div>
<p>*1) Every time the [F2](MODE) key is pressed, the mode will change as demonstrated.                      The mode is indicated in the alphabet (F, C, c) on the bottom right of the screen.                      F: Fine mode, C: Coarse 1mm mode, c: coarse 10mm mode</p>		

**4.2.6 Stake Out (S-O)**

The stake out distance is the difference between the measured distance and the preset distance.

**Display value = Measured distance -Standard (Preset) distance**

The value on the display is the distance in which the rod person must move toward or away from the instrument. A minus (-) sign appearing before the stake out distance indicates that the rod person would move away from the instrument to reach the stake out distance. If the stake out distance is displayed with no sign, indicating positive (+), the rod person toward the instrument to reach the stake out distance.

- 1 Stake out operation can be accomplished in any distance measuring mode, horizontal distance (HD), relative elevation (VD), or slope distance (SD).

[Example: Relative elevation]

Operating procedure	Operation	Display
<p><b>1</b> Press [F6](P1) key in the distance measuring mode to get the function as in page 2.</p> <p><b>2</b> Press [F2](S-O) key and press [ENT] key.</p> <p><b>3</b> Enter the relative elevation for stake out, and press [ENT] key. The measuring starts.</p> <p><b>4</b> Collimate the target (Prism).</p> <p>The difference between the measured distance and the standard distance is displayed.</p>	<p>[F6]</p> <p>[F2] [ENT]</p> <p>Enter value [ENT]</p>	<div style="border: 1px solid black; padding: 5px; margin-bottom: 5px;"> <p>V : 90°10'20"</p> <p>HR: 120°30'40"      PSM 0.0</p> <p>HD:                      PPM 0.0</p> <p>VD:                      (m) F.R</p> <p>MEAS MODE VH SD NEZ P1↓</p> <p>TURN SO MEAN m/ft P2↓</p> </div> <div style="border: 1px solid black; padding: 5px; margin-bottom: 5px;"> <p>SO</p> <p>HD : 0.000</p> <p>VD : _</p> <p>EXIT                      BS</p> </div> <div style="border: 1px solid black; padding: 5px; margin-bottom: 5px;"> <p>V : 90°10'20"</p> <p>HR : 120°30'40"      PSM 0.0</p> <p>HD :                      &lt; PPM 0.0</p> <p>dVD :                      (m) *F.R</p> <p>TURN SO MEAN m/ft P2↓</p> </div> <p style="text-align: center;">↓</p> <div style="border: 1px solid black; padding: 5px;"> <p>V : 90°10'20"</p> <p>HR: 120°30'40"      PSM 0.0</p> <p>HD: 12.345              PPM 0.0</p> <p>dVD: 0.09              (m) *F.R</p> <p>TURN SO MEAN m/ft P2↓</p> </div>
<p>1 To return to normal distance measurement mode, reset the standard distance to "0" or turn the power switch off (Resume mode: OFF) once.</p>		

### 4.3 COORDINATE MEASUREMENT

#### 4.3.1 Setting Coordinate Values of Occupied Point

The occupied point coordinates (NEZ) can be preset in the GTS-820A Series to calculate the unknown point coordinates. It is possible to retain the occupied coordinates in memory once the power is turned OFF if the (NEZ mem) is ON in the Parameter Setting Modes. IF (NEZ mem) is OFF in the Parameter Setting Modes, the occupied coordinates will be retained only if you choose (Resume ON) when shutting the power OFF.

For instructions on how to select NEZ memory ON/OFF, refer to Chapter 8 "PARAMETERS SETTING MODE" .

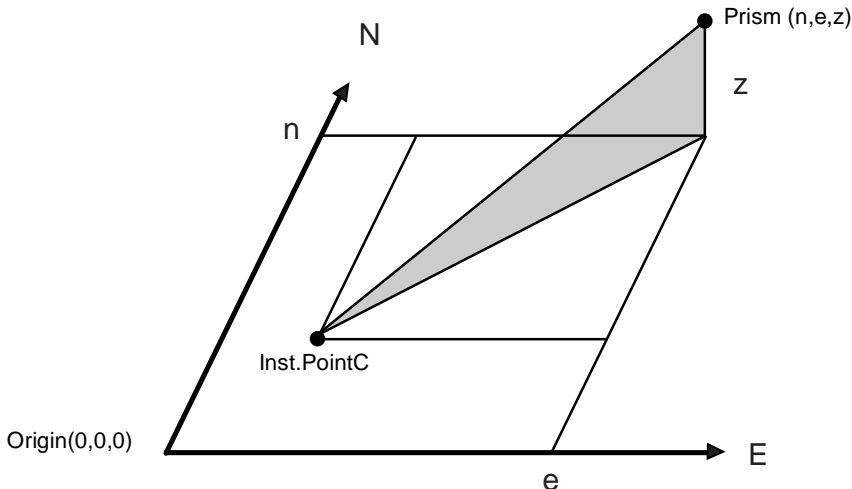

Confirm the angle measurement mode.

Operating procedure	Operation	Display
1 Press [F3](NEZ) key.	[F3]	<pre>V : 90°10'20" HR: 120°30'40"  SD HD NEZ 0SET HOLD P1↓</pre>
2 press [F6](↓) key to get the function as on page 2.	[F6]	<pre>N : &lt; E : PSM 0.0 Z : PPM 0.0 (m) *F.R MEAS MODE VH SD HD P1↓ TURN HT MEAN m/ft SET P2↓</pre>
3 Press [F5](SET) key. The previous data will be shown.	[F5]	<pre>Setting occ. point N : 12345.6700 E : 12.3400 Z : 10.2300 EXIT BS</pre>

4 Input new data and press [ENT] key. \*1)

N coord.  
[ENT]  
E coord.  
[ENT]  
Z coord.  
[ENT]

Measuring starts.

```
Setting occ. point
N : 0.0000
E : 0.0000
Z : 0.0000
EXIT BS
```

```
Complete
```



```
N : <
E : PSM 0.0
Z : PPM 0.0
(m) *F.R
TURN HT MEAN m/ft SET P2↓
```

\*1)To cancel the setting, press [F1](EXIT) key.

### 4.3.2 Setting of the Instrument Height / Prism Height

The instrument height and prism height are used to compute the ground elevation of the unknown point. If the option to store NEZ is (on), the instrument and prism heights will be stored in memory when power is turned off.

Confirm the angle measurement mode.

Operating procedure	Operation	Display
<p><b>1</b> Press [F3](NEZ) key.</p>	[F3]	<pre>V : 90°10'20" HR: 120°30'40"  SD  HD  NEZ  0SET  HOLD  P1↓</pre>
<p><b>2</b> Press [F6](↓) key from the coordinate measurement mode to get the function as in page 2.</p>	[F6]	<pre>N : E :                PSM  0.0 Z :                PPM  0.0                     (m) *F.R MEAS MODE VH  SD  HD  P1↓ TURN HT MEAN m/ft SET  P2↓</pre>
<p><b>3</b> Press [F2](HT) key to type in the instrument and prism height. Previous data will be shown.</p>	[F2]	<pre>Inst. Ht   :  1.230 m R. Ht     :  1.340 m  EXIT                               BS</pre>
<p><b>4</b> Input instrument height, and press [ENT] key.*1)</p> <p><b>5</b> Input prism height, and press [ENT] key.</p> <p>The display returns to coordinate measuring mode.</p>	<p>Inst. HT [ENT]</p> <p>Prism HT [ENT]</p>	<pre>N : E :                PSM  0.0 Z :                PPM  0.0                     (m) *F.R TURN HT MEAN m/ft SET  P2↓</pre>
<p>*1)To cancel the setting, press [F1](EXIT) key.</p>		

### 4.3.3 Execution of Coordinate Measuring

Measure the coordinates by entering the instrument height and prism height, coordinates of unknown point will be measured directly.

- 1 When setting coordinate values of occupied point, see Section 4.3.1“Setting Coordinate Values of Occupied Point” .
- 1 When setting the instrument height and prism height, see Section 4.3.2“Setting of the Instrument Height / Prism Height” .
- 1 The coordinates of the unknown point are calculated as shown below and displayed:

Coordinates of occupied point :  $(N_0, E_0, Z_0)$   
 Instrument height : Inst.h  
 Prism height : R.h  
 Vertical distance (Relative elevation) : z  
 Coordinates of the center of the prism,  
 originated from the center point of the instrument :  $(n, e, z)$   
 Coordinates of unknown point :  $(N_1, E_1, Z_1)$

$$N_1 = N_0 + n$$

$$E_1 = E_0 + e$$

$$Z_1 = Z_0 + \text{Inst.h} + z - P.h$$

Coordinates of the center of the prism, originated from the center point of the instrument  $(n, e, z)$

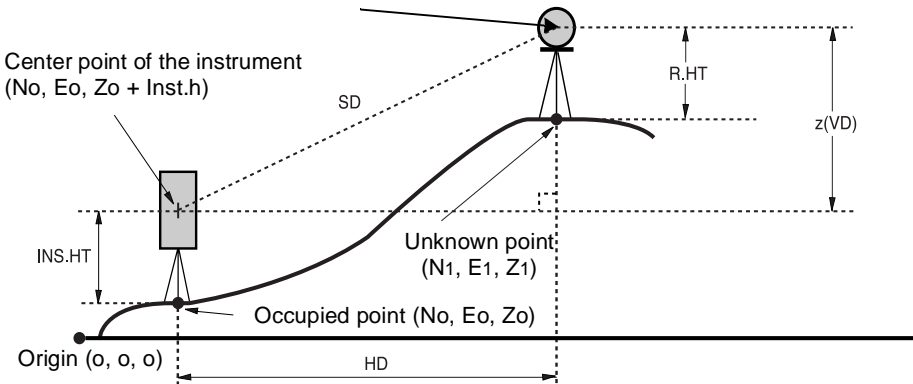

Confirm the angle measurement mode.

Operating procedure	Operation	Display
<b>1</b> Set coordinates values of occupied point and instrument/prism height. *1) <b>2</b> Set the direction angle of known point A. *2)	Set direction angle	<pre>V : 90°10'20" HR: 120°30'40"  SD HD NEZ OSET HOLD P1↓</pre>
<b>3</b> Collimate target B. <b>4</b> Press [F3](NEZ) key.*3) Measuring starts.	Collimate  [F3]	<pre>N : &lt; E : PSM 0.0 Z : PPM 0.0       (m) *F.R MEAS MODE VH SD HD P1↓</pre>

The result will be shown.

↓

N	:	12345.6789			
E	:	-12345.6789	PSM	0.0	
Z	:	10.1234	PPM	0.0	
			(m)	*F.R	
MEAS	MODE	VH	SD	HD	P1↓

- \*1) In case the coordinate of instrument point is not entered, (0,0,0) will be used as the default for the instrument point.  
The instrument height will be calculated as 0 when the instrument height is not entered.
  - \*2) The prism height will be calculated as 0 when the prism height is not set.
  - \*3) Refer to Section 4.1.3“Measuring from the Required Horizontal Angle”or Section 4.1.3“Measuring from the Required Horizontal Angle”
  - \*4) Pressing [F1](MEAS) key, the measurement mode (Continuous measuring/ N-time measuring) changes.  
Pressing [F2](MODE) key, the measurement mode (FINE/ COARSE(1mm)/ COARSE(10mm)) changes.
- 1 To return to the normal angle or distance measuring mode, press [F6](P2↓) key to return to the function as on page 1 and press [F3](VH),[F4](SD) or [F5](HD) key.



### 4.4 DATA OUTPUT

Result of measurement is transferred to Data Collector (FC series) from GTS-820A series.

[Example: Distance measurement mode]

Confirm the distance measurement mode.

Operating procedure	Display
<p><b>1</b> Operate the data collector to measure the distance. Measurement will be started.</p>	<pre>V : 90°10'20" HR: 120°30'40"      PSM  0.0 HD:                &lt;    PPM  0.0 VD:                (m) *F.R MEAS  MODE  VH   SD  NEZ  P1↓</pre>
<p><b>2</b> The result will be shown and transferred to the Data Collector.</p>	<pre>V : 90°10'20" HR: 120°30'40"      PSM  0.0 HD:   10.1234      PPM  0.0 VD:   1.234      (m) *F.R REC  &gt; &gt; &gt;</pre>
<p><b>3</b> The mode will automatically return to the distance measurement mode.</p>	<pre>V : 90°10'20" HR: 120°30'40"      PSM  0.0 HD:   10.1234      PPM  0.0 VD:   1.234      (m) *F.R MEAS  MODE  VH   SD  NEZ  P1↓</pre>

The following data will be output at each mode.

Mode	Output
Angle mode (V,HR or HL) (V in percent)	V, HR (or HL)
Horizontal distance mode (V, HR, HD, VD)	V, HR, HD, VD
Slope distance mode (V, HR,SD)	V, HR, SD,HD
Coordinate mode	N, E, Z, HR

- 1 The display and the output at the coarse (1mm) mode are the same as the contents above.
- 1 Output at the coarse (10mm) mode is displayed as distance data only (HD, VD or SD).

The information of GTS-820A series regarding tracking auto-tracking are added to the protocol of Topcon Total Station system so far.

Also you can add utility information such as battery remaining, EDM mode, auto-tracking mode, normal/reversed face information, Tilt information if you like. For selecting, refer to Chapter 8 "PARAMETERS SETTING MODE".

During an utility function selection, measurement will be continued whenever tilt over. The tilt over will not be compensated here.

In case tilt over, the tilt information will be displayed on the upper right screen as the following marks during the utility function is selected.

V : 90° 10'20"	[t]
HR: 120° 30'40"	PSM 0.0
HD: <	PPM 0.0
VD: (m) *c.R	
MEAS MODE VH SD NEZ P1↓	

Tilt information

Marks	Status of tilt
[t]	Under tilt compensation
[?]	Tilt Over
[*]	Tilt OFF

- 1 Control by interface for Topcon AP-L1A system, see Chapter 5 “PROGRAM MODES” -[EXT.LINK] section.
- 1 When using other wireless modem or optical remote controller, select to [None] for the protocol of communication in Chapter 8 “PARAMETERS SETTING MODE” .

# 5 PROGRAM MODES

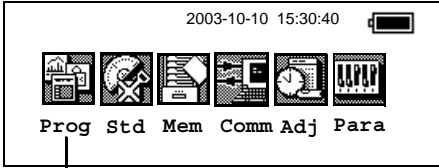

[Press [F1] key.]

- PROGRAM MODE (APPLICATION MEASUREMENT)**
- 1.Setting a Horizontal Angle
  - 2.Retaining a Coordinate (STORE-NEZ)
  - 3.Remote Elevation Measurement (REM)
  - 4.Missing Line Measurement (MLM)
  - 5.Line Measurement (LINE)
  - 6.Offset Measurements (OFF SET)
  - 6.External Link

1 The loaded measuring programs are added on this menu.

Programs			
F1	BS	p	4/7
F2	STORE	p	
F3	REM	p	
F4	MLM	p	MORE

[F6](MORE) key

Programs			
F1	LINE	p	7/7
F2	OFFSET	p	
F3	EXT.LINK	p	
			MORE

## 5.1 Setting a Direction Angle for Backsight Orientation

### (Entering the instrument and backsight coordinate values)

From the coordinate value of backsight point (bearing point) and instrument point, the direction angle from the instrument point to the backsight point can be set.

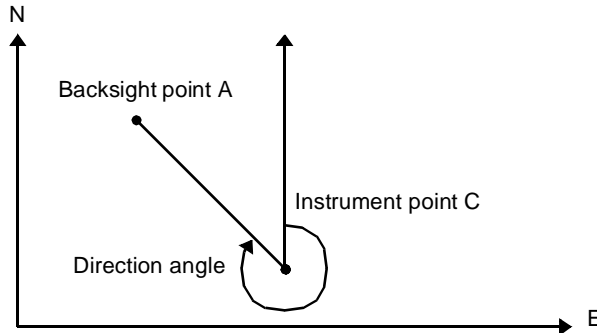

Example: Backsight point A : N coordinate 54.321m, E coordinate 12.345m

Operating procedure	Operation	Display
<p><b>1</b> Press [F1](BS) key. Current data will be displayed. *1)</p> <p><b>2</b> Press [F6](OK) key.</p> <p><b>3</b> Input N and E coordinate of backsight point A.  Example : N coordinate;54.321m           : E coordinate;12.345m</p> <p><b>4</b> Sight backsight point A.</p> <p><b>5</b> Press [F5](YES) key.</p> <p>The display returns to main menu.</p>	[F1]	<pre> Programs ----- F1 BS      p          4/7 F2 STORE  p F3 REM    p F4 MLM    p          MORE           </pre>
	[F6]	<pre> Setting Direction Angle BS:M-POINT N :   1234.567 m E :   2345.678 m INP                OK           </pre>
	N data [ENT] E data [ENT]	<pre> Setting Direction Angle BS:T-POINT N :       54.321 m E :       12.345 m EXIT                BS           </pre>
	[F5]	<pre> Setting Direction Angle BS HR : 320°10'20" &gt; Set OK? EXIT                YES  NO           </pre>
<p>*1)If you need to change the occupied point data, press [F1](INP) key and input new data.</p>		

## 5.2 Retaining a Coordinate (STORE- NEZ)

Suppose the instrument P0 moves to P1, P2, P3, etc. and the coordinate at P1, P2, P3 etc., last point will be retained in the memory, after moving, as from the origin point.

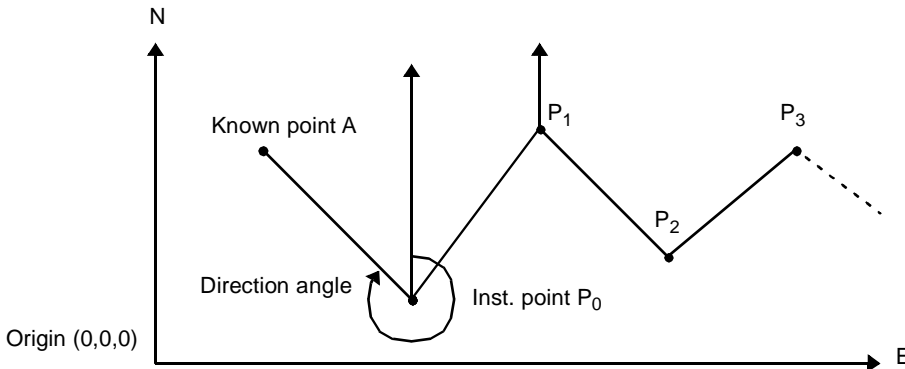

- 1 Set the coordinate value of instrument point P0 and set the direction angle from instrument point P0 toward known point A .

Operating procedure	Operation	Display
1 Press [F2](STORE) key.	[F2]	<pre> Programs ----- F1 BS      p          4/7 F2 STORE   p F3 REM     p F4 MLM     p          MORE                     </pre>
2 Press [F1](Store NEZ) key. *1)	[F1]	<pre> Retaining Coordinate 1.Store NEZ 2.Recall NEZ                     </pre>
3 Collimate target P1 prism which the instrument moves.	Collimate P1	
4 Press [F1](MEAS) key. Measuring will start.	[F1]	<pre> Store NEZ HR : 120°30'40" HD :                m MEAS                HT SET                     </pre>
		↓
Horizontal distance and horizontal angle are shown.		<pre> Store NEZ HR : 100°10'20" HD * 123.456 m MEAS                SET                     </pre>

<p><b>5</b> Press [F6](SET) key. Coordinate of P1 will be displayed.</p>	<p>[F6]</p>	<pre> Store NEZ N : 123.456 m E : 12.345 m Z : 1.234 m &gt; SET OK?      YES  NO             </pre>
<p><b>6</b> Press [F5](YES) key. Coordinate of P1 will be decided.</p>	<p>[F5]</p>	<pre> Complete             </pre>
<p>The display return to main menu.</p> <p>Turn power off and move instrument to P1 ( Prism P1 move to P0).</p>	<p>Power off</p> <p>Move to P1</p>	
<p><b>7</b> After the instrument is set up at P1, turn power on and be measurement possible.</p>	<p>Power on Select program</p>	<pre> Programs F1 BS      p      4/7 F2 STORE  p F3 REM     p F4 MLM     p      MORE             </pre>
<p><b>8</b> Press [F2](STORE) key.</p>	<p>[F2]</p>	<pre> Retaining a Coordinate 1.Store NEZ 2.Recall NEZ             </pre>
<p><b>9</b> Press [F2](Recall NEZ) key.</p>	<p>[F2]</p>	<pre> Recall NEZ  HR: 300°10'20" &gt; Set OK?      YES  NO             </pre>
<p><b>10</b> Collimate P0, the former instrument point.</p>	<p>Collimate P0</p>	
<p><b>11</b> Press [F5](YES) key.</p> <p>The coordinates at P1 and direction angle toward P0 are set.</p> <p>The display return to main menu.</p>	<p>[F5]</p>	<pre> Complete             </pre>
<p><b>12</b> Repeat the procedure <b>1 ~ 11</b> as much as you wish.</p>		

\*1)To reset the instrument height or prism height, press [F5](HT) key.

### 5.3 Remote Elevation measurement (REM)

To obtain elevation of the point at which setting the target prism is not possible, place the prism at any point on the vertical line from the target then carry out REM procedure as follows.

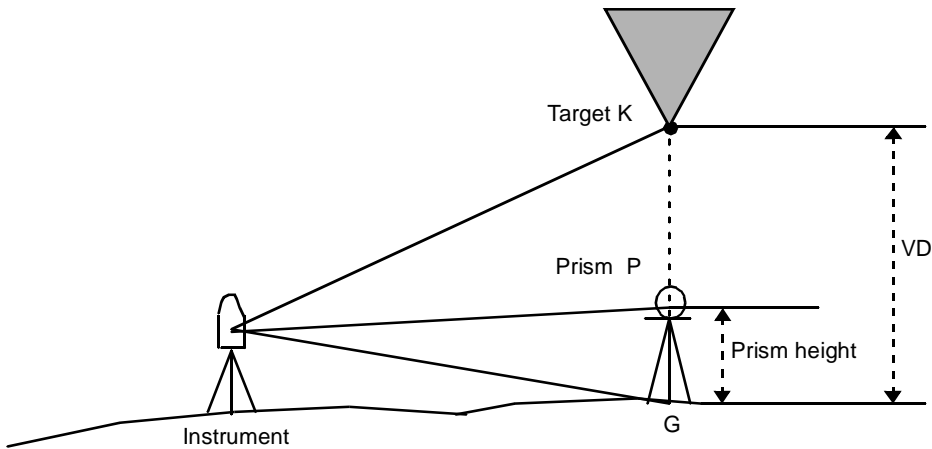

#### 1) With prism height (h) input (Example :h=1.5m)

Operating procedure	Operation	Display
1 Press [F3](REM) key.	[F3]	<pre> Programs ----- F1 BS   p           4 / 7 F2 STORE p F3 REM   p F4 MLM   p           MORE           </pre>
2 Press [F1](YES) key.	[F1]	<pre> REM Prism height 1.YES 2.NO           </pre>
3 Enter prism height, press [ENT] key.	Enter P.HT [ENT]	<pre> REM (1)Prism Height   P.h :           m  EXIT                               BS           </pre>
4 Collimate prism .	Collimate P	<pre> REM (2)Horizontal Distance   HD :           m  MEAS                               SET           </pre>
5 Press [F1](MEAS) key. Measuring starts.	[F1]	<pre> REM (2)Horizontal Distance   HD *           &lt; m  MEAS                               SET           </pre> <p style="text-align: center;">↓</p>

<p>Horizontal distance (HD) between the instrument and prism will be shown.</p>	[F6]	<pre>REM (2)Horizontal Distance   HD :   123.456 m  MEAS                                SET</pre>
<p><b>6</b> Press [F6](SET) key. The prism position will be decided. *1)</p>	Collimate K	<pre>REM    VD :     0.234 m  EXIT P.h HD                        SET</pre>
<p><b>7</b> Collimate target K. Vertical distance (VD) will be shown. *2)</p>		<pre>REM    VD :     1.456 m  EXIT P.h HD</pre>
<p>*1)To return to procedure <b>3</b>, press [F2](P.h) key. To return to procedure <b>4</b>, press [F3](HD) key. *2)To return to main menu, press [F1](EXIT) key.</p>		

**2)Without prism height input.**

Operating procedure	Operation	Display
<b>1</b> Press [F3](REM) key.	[F3]	<pre>Programs ----- F1 BS   p           4/7 F2 STORE p F3 REM   p F4 MLM  p           MORE</pre>
<b>2</b> Press [F2](NO) key.	[F2]	<pre>REM Prism height 1.YES 2.NO</pre>
<b>3</b> Collimate prism.	Collimate P	<pre>REM (1)Horizontal Distance   HD :           m  MEAS</pre>
<b>4</b> Press [F1](MEAS) key. Measuring starts.	[F1]	<pre>REM (1)Horizontal Distance   HD*           &lt; m  MEAS                                SET</pre>
Horizontal distance (HD) between the instrument and prism will be shown.		<p style="text-align: center;">↓</p> <pre>REM (1)Horizontal Distance   HD :   123.456 m  MEAS                                SET</pre>



<p><b>5</b> Press [F6](SET) key. The prism position will be decided.</p>	[F6]	<pre> REM (2)Vertical Angle   V :   120°30'40"  SET </pre>
<p><b>6</b> Collimate ground point G.</p>	Collimate G	<pre> REM (2)Vertical Angle   V :   95°30'40"  SET </pre>
<p><b>7</b> Press [F6](SET) key. The position of point G will be decided. *1)</p>	[F6]	<pre> REM VD :      0.000 m EXIT HD  V </pre>
<p><b>8</b> Collimate target K. Vertical distance (VD) will be shown. *2)</p>	Collimate K	<pre> REM VD :      9.876 m EXIT HD  V </pre>
<p>*1) To return to procedure <b>3</b>, press [F2](HD) key. To return to procedure <b>6</b>, press [F3](V) key. *2) To return to main menu, press [F1](EXIT) AND [F5](YES) key.</p>		

### 5.4 Missing Line Measurement (MLM)

Measurement for horizontal distance (dHD), slope distance (dSD) and elevation (dVD) between two target prisms.

MLM mode has two mods.

- 1.(A-B, A-C):Measurement is A-B, A-C, A-D,.....
- 2.(A-B, B-C):Measurement is A-B, B-C, C-D,.....

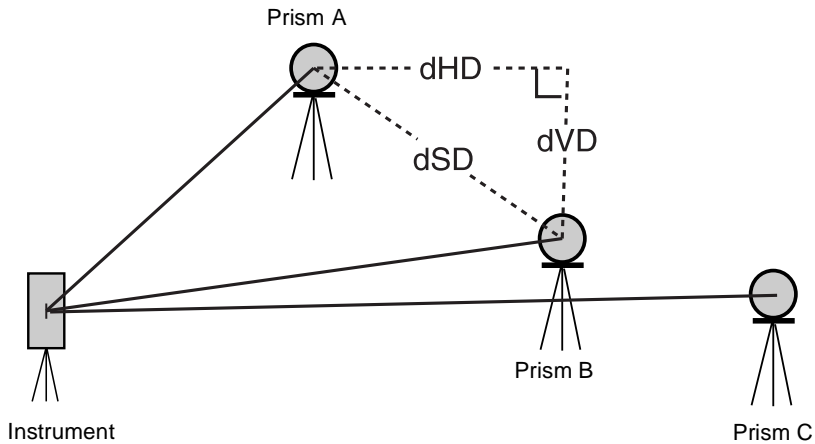

[Example] 1. (A-B, A-C)

1 Procedure of 2. (A-B, B-C) mode is completely same as MLM-1 mode.

Operating procedure	Operation	Display
<b>1</b> Press [F4](MLM) key.  <b>2</b> Press [F1](A-B, A-C) key.	[F4]	<pre>                     Programs                     -----                     F1 BS    p          4/7                     F2 STORE p                     F3 REM   p                     F4 MLM   p          MORE                 </pre>
	[F1]	<pre>                     Missing Line Measurement                     1. (A-B, A-C)                     2. (A-B, B-C)                 </pre>
		<pre>                     MLM 1                     Horizontal Distance 1                     HD :          m                     MEAS                               SET                 </pre>

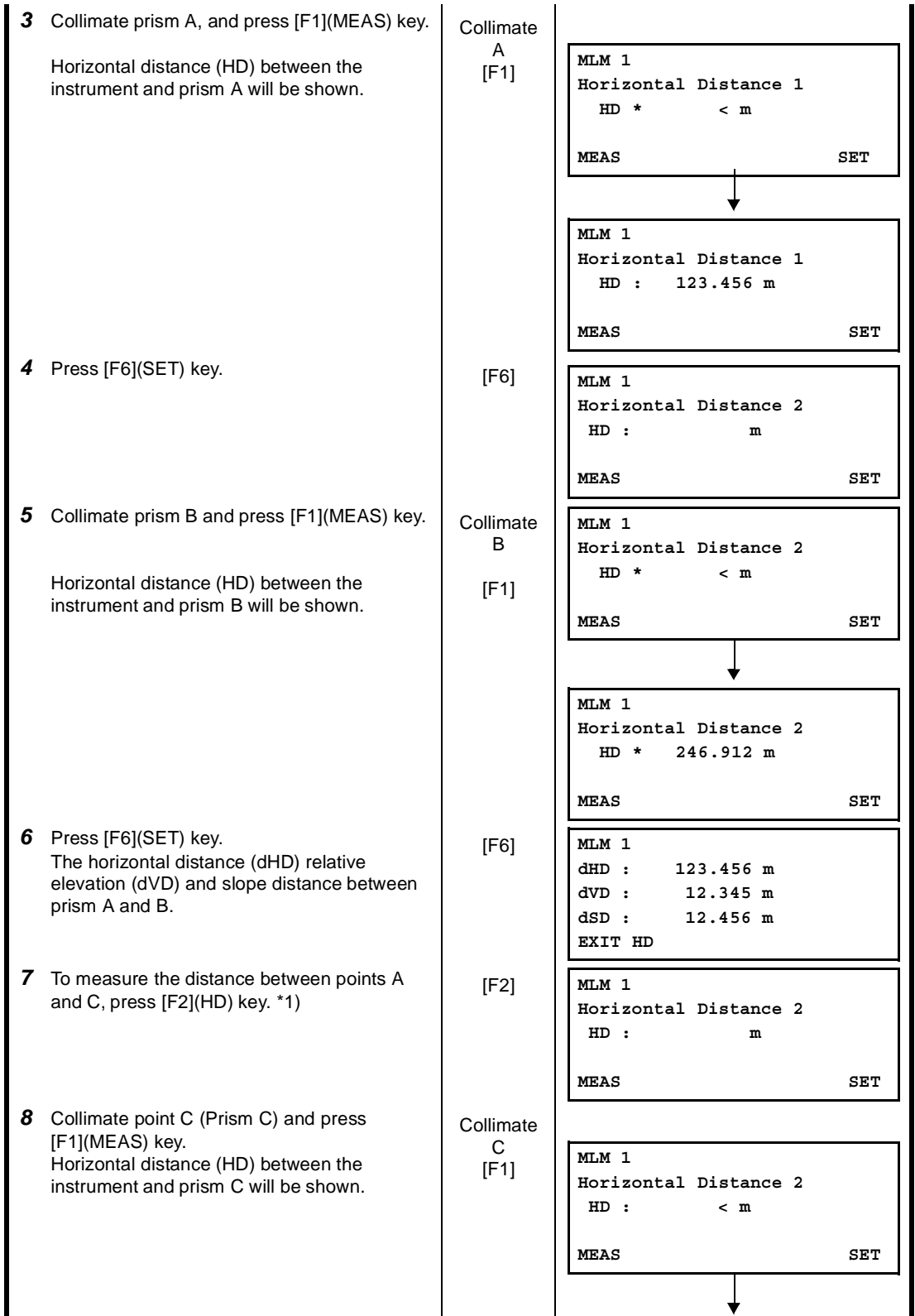

- 9** Press [F6]( SET) key.  
The horizontal distance (dHD) relative elevation (dVD) and slope distance between prism A and C.

- 10** To measure the distance between points A and D, repeat procedure **7** to **9**. \*1)

[F6]

```
MLM 1
Horizontal Distance 2
  HD *   246.912 m

MEAS                                     SET
```

```
MLM 1
dHD :    123.456 m
dVD :    12.345 m
dSD :    12.456 m
EXIT HD
```

\*1) To return to main menu, press [F1](EXIT) and [F5](YES) key.

### 5.5 Line Measurement (LINE)

This mode is useful to obtain the line height.

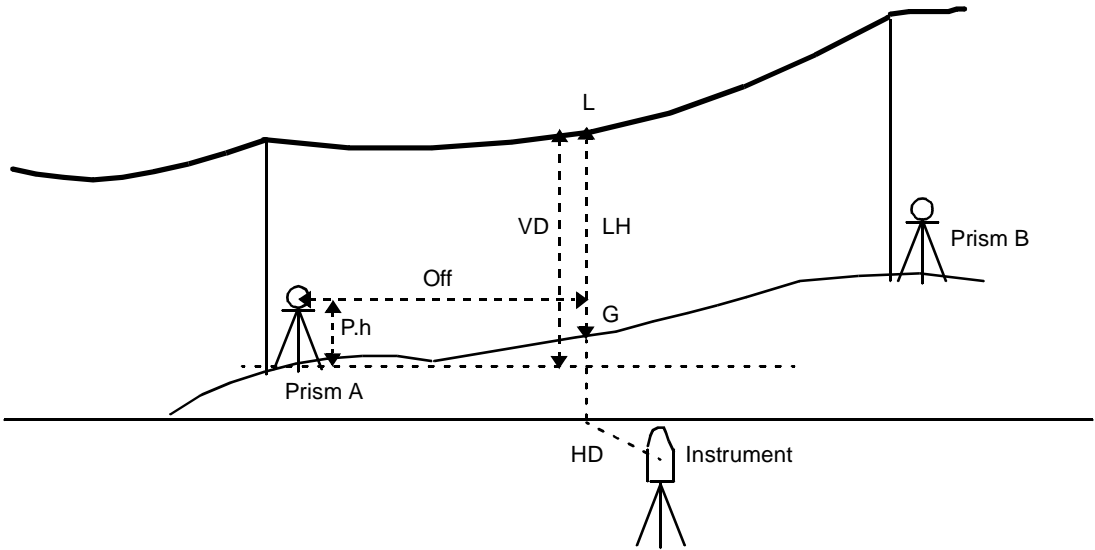

[Example:Input of prism height]

Operating procedure	Operation	Display
<ol style="list-style-type: none"> <li>1 Press [F6](MORE) key from programs menu to get the next page of programs.</li> <li>2 Press [F1](LINE) key.</li> <li>3 Press [F1](YES) key.</li> <li>4 Input the prism height and press [ENT] key.</li> </ol>	[F6]	<pre> Programs ----- F1 BS      p      4/7 F2 STORE   p F3 REM     p F4 MLM     p      MORE                     </pre>
	[F1]	<pre> Programs ----- F1 LINE    p      7/7 F2 OFFSET  p F3 EXT.LINK p      MORE                     </pre>
	[F1]	<pre> LINE Prism height 1 YES 2 NO                     </pre>
	Input P.h [ENT]	<pre> LINE Prism height P.h:           m EXIT           BS                     </pre>
		<pre> LINE &lt;STEP-1&gt;PT A HD:           m MEAS         SET                     </pre>

<p><b>5</b> Collimate prism A and press [F1](MEAS) key. The distance measurement will start.</p> <p>Horizontal distance is displayed.</p>	<p>Collimate A [F1]</p>	<pre> LINE &lt;STEP-1&gt;P T A HD*                &lt; m                     </pre>
<p><b>6</b> Press [F6] (SET) key, and horizontal distance will be recorded.</p>	<p>[F6]</p>	<pre> LINE &lt;STEP-1&gt;PT A HD*                50.234 m MEAS                SET                     </pre>
<p><b>7</b> Collimate prism B and press [F1](MEAS) key. The distance measurement will start.</p> <p>Horizontal distance is displayed.</p>	<p>Collimate B [F1]</p>	<pre> LINE &lt;STEP-1&gt;PT B HD:                m MEAS                SET                     </pre>
<p><b>8</b> Press [F6] (SET) key, and horizontal distance will be recorded.</p>	<p>[F6]</p>	<pre> LINE &lt;STEP-1&gt;PT B HD*                67.543 m MEAS                SET                     </pre>
<p><b>9</b> Sight line point L . Measured data to the line point L is displayed. VD:Vertical distance. HD:Horizontal distance from the instrument to L. Off :Horizontal distance from A to L.</p>	<p>Sight L</p>	<pre> LINE VD:    20.123 m HD:    38.987 m Off:   74.123 m EXIT LH                     </pre>
<p><b>10</b> Press [F2](LH) key. This function is used when measuring the line height from the ground. The procedure is as follows :</p> <p>1 Sight the point on the line before pressing this key.</p> <p>1 Don't move the horizontal tangent screw by setting ground point G.</p>	<p>[F2]</p>	<pre> LINE G-POINT V :   30°20'10" EXIT                SET                     </pre>

<p><b>11</b> Rotate the vertical tangent screw, and sight ground point G.</p> <p><b>12</b> Press [F6] (SET) key, line height (LH) and horizontal distance (Off) are displayed.</p>	<p>Sight G</p> <p>[F6]</p>	<table border="1"> <tr> <td colspan="2">LINE</td> </tr> <tr> <td colspan="2">G-POINT</td> </tr> <tr> <td>V :</td> <td>90°40'20"</td> </tr> <tr> <td>EXIT</td> <td>SET</td> </tr> </table> <table border="1"> <tr> <td colspan="2">LINE</td> </tr> <tr> <td>LH:</td> <td>33.765 m</td> </tr> <tr> <td>Off:</td> <td>27.521 m</td> </tr> <tr> <td>EXIT</td> <td>VD</td> </tr> <tr> <td></td> <td>NEXT</td> </tr> </table>	LINE		G-POINT		V :	90°40'20"	EXIT	SET	LINE		LH:	33.765 m	Off:	27.521 m	EXIT	VD		NEXT
LINE																				
G-POINT																				
V :	90°40'20"																			
EXIT	SET																			
LINE																				
LH:	33.765 m																			
Off:	27.521 m																			
EXIT	VD																			
	NEXT																			
<p>1 To finish the measurement, press the [F1](EXIT) or [ESC] key.</p> <p>1 To return to operation procedure <b>9</b>, press the [F2](VD) key.</p> <p>1 To return to operation procedure <b>11</b>, press the [F6](NEXT) key.</p> <p>The NEXT key is used when the ground point G is not clear and you would like to check another ground point G on the same vertical line.</p>																				

## 5.6 Offset measurement (OFFSET)

There are four offset measurement modes in the Offset Measurement.

- 1 Angle offset
- 1 Distance offset
- 1 Plane offset
- 1 Column offset

Offset Measurement Menu

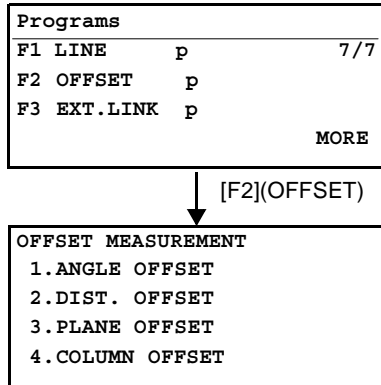

### 1 Outputting the Measurement Data

The results of offset measurement can be output to external device.

In offset measurement mode, the [F4] soft key which assigned (REC) will appear in measured result display.

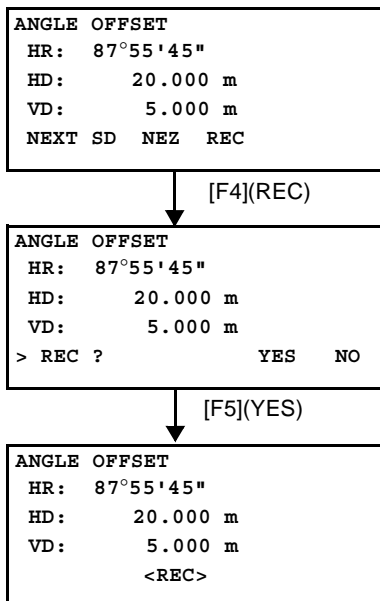

### 1 Distance measurement mode of the offset measurement

Offset measurement will be done by N-time fine measurement mode.



### 5.6.1 Angle Offset

This mode is useful when it is difficult to set up the prism directly, for example at the center of a tree. Place the prism at the same horizontal distance from the instrument as that of point A<sub>0</sub> to measure. To measure the coordinates of the center position, operate the offset measurement after setting the instrument height/prism height.

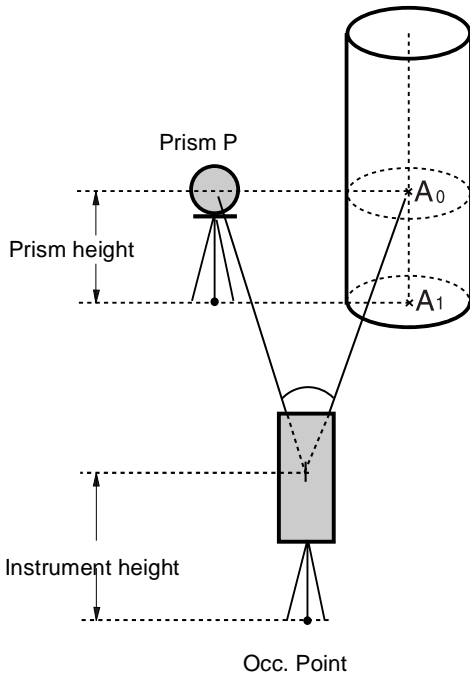

When measuring coordinates of ground point A<sub>1</sub> :Set the instrument height/prism height.

When measuring coordinates of point A<sub>0</sub> : Set the instrument height only. (Set the prism height to 0).

When sighting to A<sub>0</sub>, you can select one of two ways. [HOLD] is to fix vertical angle to the prism position even updown the telescope position, and [FREE] is to gear vertical angle to the updown of telescope movement. In case following the vertical angle to the movement of telescope, SD(Slope Distance) and VD(Vertical Distance) will be changed according to the movement of telescope.

Operating procedure	Operation	Display
1 Press [F6](MORE) key from programs menu to get to the next page of programs.	[F6]	<pre> Programs ----- F1 BS      p                4/7 F2 STORE  p F3 REM    p F4 MLM    p                MORE                     </pre>
		<pre> Programs ----- F1 LINE   p                7/7 F2 OFFSET p F3 EXT.LINK p                     MORE                     </pre>
2 Press [F2](OFFSET) key.	[F2]	<pre> OFFSET MEASUREMENT 1.ANGLE OFFSET 2.DIST. OFFSET 3.PLANE OFFSET 4.COLUMN OFFSET                     </pre>
3 Press [F1](ANGLE OFFSET) key.	[F1]	<pre> ANGLE OFFSET 1.FREE V-ANGLE 2.HOLD V-ANGLE                     </pre>

<p><b>4</b> Select the vertical angle [FREE] or [HOLD]. *1)</p>	[F1]or [F2]	<pre> ANGLE OFFSET HD:                m MEAS                HT </pre>
<p><b>5</b> Collimate prism P, and press the [F1](MEAS) key. *1)</p> <p>The horizontal distance from the instrument to the prism will be measured.</p>	Collimate P [F1]	<pre> ANGLE OFFSET HD*                &lt; m MEAS                HT </pre> <p style="text-align: center;">↓</p> <pre> ANGLE OFFSET HR:   20°30'40" HD:   20.000 m VD:   0.000 m NEXT SD NEZ REC </pre>
<p><b>6</b> Collimate point A<sub>0</sub> using the horizontal motion clamp and horizontal tangent screw.</p>	Collimate A <sub>0</sub>	<pre> ANGLE OFFSET HR:   30°00'00" HD:   20.000 m VD:   0.000 m NEXT SD NEZ REC </pre>
<p><b>7</b> To show the slope distance of point A<sub>0</sub>, press the [F2](SD) key.</p>	[F2]	<pre> ANGLE OFFSET V :   90°00'00" HR:   30°00'00" SD:   20.000 m NEXT HD NEZ REC </pre>
<p><b>8</b> To show the coordinates, press the [F3](NEZ) key. *2)</p>	[F3]	<pre> ANGLE OFFSET N :   17.321 m E :   10.000 m Z :   0.000 m NEXT SD HD REC </pre>
<p>*1) To set the prism height or instrument height, press the [F5](HT) key.  *2) To repeat angle offset measurement, press the [F1](NEXT) key. The display will return to step 5.</p>		

### 5.6.2 Distance Offset Measurement

The measurement of a place apart from a prism is possible by inputting offset horizontal distance of front and back / right and left.

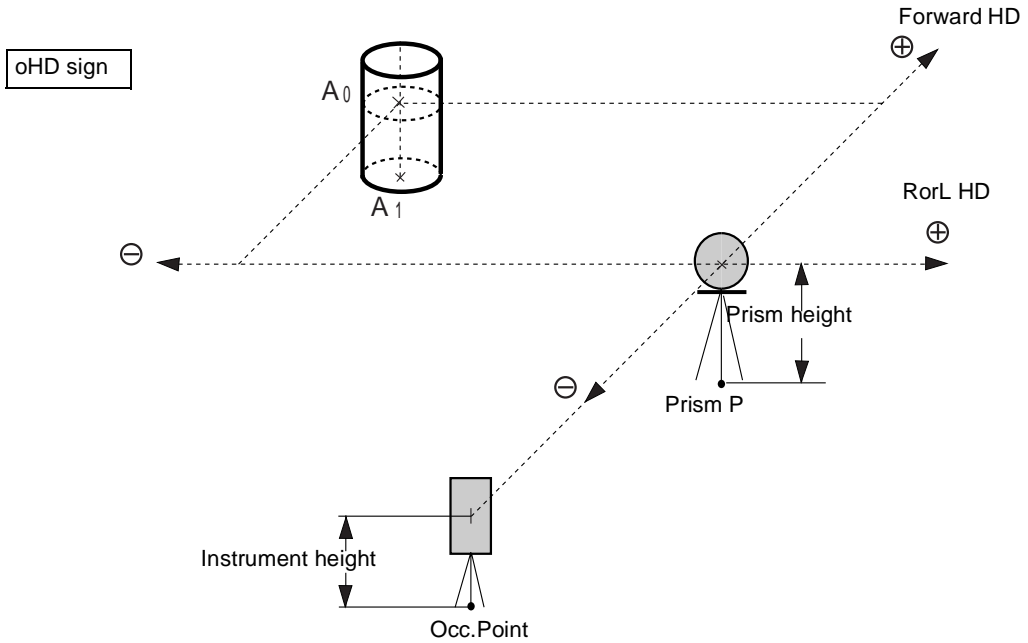

When measuring coordinates of ground point A<sub>1</sub>: Set the instrument height / prism height.

When measuring coordinates of point A<sub>0</sub>: Set the instrument height only.  
(Set the prism height to 0).

Operating procedure	Operation	Display
<p><b>1</b> Press [F6](MORE) key from programs menu to get to the next page of programs.</p> <p><b>2</b> Press [F2](OFFSET) key.</p> <p><b>3</b> Press [F2](DIST. OFFSET) key.</p> <p>Previous offset value screen will appear. dFR: Forward/Rear offset value dRL: Right/Left offset value</p>	[F6]	<pre> Programs ----- F1 BS    p          4/7 F2 STORE p F3 REM   p F4 MLM   p          MORE                     </pre>
	[F2]	<pre> Programs ----- F1 LINE   p          7/7 F2 OFFSET p F3 EXT.LINK p                     MORE                     </pre>
	[F2]	<pre> OFFSET MEASUREMENT 1.ANGLE OFFSET 2.DIST. OFFSET 3.PLANE OFFSET 4.COLUMN OFFSET                     </pre>
	[F2]	<pre> DIST. OFFSET dFR : 0.000 m dRL : 0.000 m  OK                               INP                     </pre>

<p><b>4</b> If you reset the offset value, press the [F6](INP) key and input the value. *1)</p>	[F6]	<pre> DIST. OFFSET dFR : 0.000 m dRL : 0.000 m  EXIT                               BS </pre>
<p><b>5</b> Collimate prism using the horizontal motion clamp and horizontal tangent screw. Press the [F1](MEAS) key. *2)</p> <p>The offset measurement data will be shown.</p>	Collimate P [F1]	<pre> DIST. OFFSET  HD:                               m  MEAS                               HT </pre> <p style="text-align: center;">↓</p> <pre> DIST. OFFSET HR:   30°00'00" HD:   20.000 m VD:   0.000 m NEXT SD NEZ REC </pre>
<p><b>6</b> To show the slope distance of point A<sub>0</sub>, press the [F2](SD) key.</p>	[F2]	<pre> DIST. OFFSET V :   90°00'00" HR:   30°00'00" SD:   20.000 m NEXT HD NEZ REC </pre>
<p><b>7</b> To show the coordinates, press the [F3](NEZ) key. *3)</p>	[F3]	<pre> DIST. OFFSET N :   17.321 m E :   10.000 m Z :   0.000 m NEXT SD HD REC </pre>
<p>*1) To skip the input, press the [F1](OK) key.  *2) To set the prism height or instrument height, press the [F5](HT) key.  *3) To repeat the offset measurement, press the [F1](NEXT) key. The display will return to step 5.</p>		

### 5.6.3 Plane Offset Measurement

Measuring will be taken for the place where direct measuring can not be done, for example distance or coordinate measuring for a edge of a plane.

Three random target points (P1, P2, P3) on a plane will be measured at first in the plane offset measurement to determine the measured plane. Collimate the measuring target point (P0) then the instrument calculates and displays coordinate and distance value of cross point between collimation axis and of the plane.

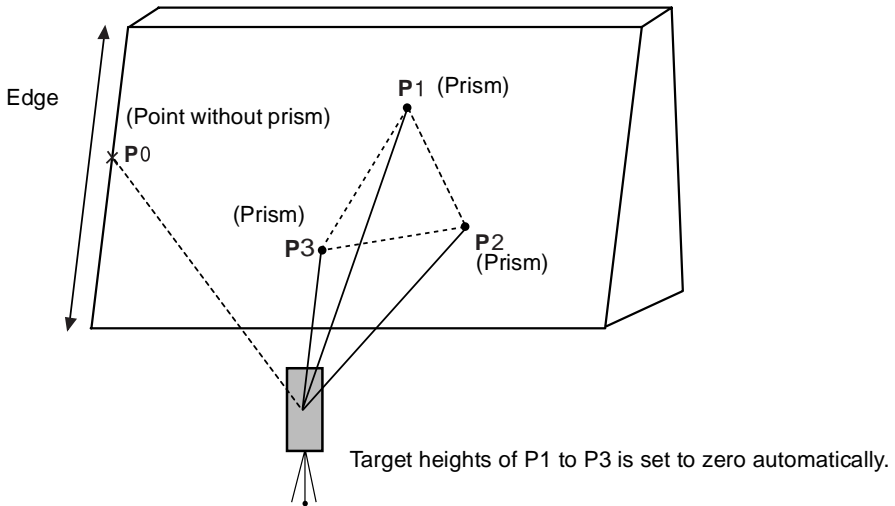

Operating procedure	Operation	Display
<p><b>1</b> Press [F6](MORE) key from programs menu to get to the next page of programs.</p>	<p>[F6]</p>	<pre> Programs ----- F1 BS      p                4/7 F2 STORE   p F3 REM     p F4 MLM     p                MORE                     </pre>
<p><b>2</b> Press [F2](OFFSET) key.</p>	<p>[F2]</p>	<pre> Programs ----- F1 LINE    p                7/7 F2 OFFSET  p F3 EXT.LINK p                MORE                     </pre>
<p><b>3</b> Press [F3](PLANE OFFSET) key.</p> <p>Measurement screen of three points on a plane will be shown.</p>	<p>[F3]</p>	<pre> OFFSET MEASUREMENT 1.ANGLE OFFSET 2.DIST. OFFSET 3.PLANE OFFSET 4.COLUMN OFFSET  PLANE OFFSET N001# SD :          m  MEAS          HT                     </pre>

<p><b>4</b> Collimate prism P1, and press the [F1](MEAS) key. Measuring will start. After measuring, the second point measurement screen will be shown.</p>	<p>Collimate P1 [F1]</p>	<pre> PLANE OFFSET N002# SD :                m MEAS                HT                     </pre>
<p><b>5</b> Measure the second and third prism in the same way. *1)</p> <p>The instrument calculates and displays coordinate and distance value of cross point between collimation axis and of the plane. *2)</p>	<p>Collimate P2 [F1] Collimate P3 [F1]</p>	<pre> PLANE OFFSET N003# SD :                m MEAS                HT                     </pre> <p style="text-align: center;">↓</p> <pre> PLANE OFFSET HR:      85°30'40" HD:      54.321 m VD:      10.000 m NEXT SD NEZ REC                     </pre>
<p><b>6</b> Collimate point P0 on the plane using the horizontal motion clamp and horizontal tangent screw.</p> <p>P0 data will be shown.</p>	<p>Collimate P0</p>	<pre> PLANE OFFSET HR:      75°30'40" HD:      54.600 m VD:      -0.487 m NEXT SD NEZ REC                     </pre>
<p><b>7</b> To show the slope distance of point P<sub>0</sub>, press the [F2](SD) key.</p>	<p>[F2]</p>	<pre> PLANE OFFSET V :      90°30'30" HR:      75°30'40" SD:      54.602 m NEXT HD NEZ REC                     </pre>
<p><b>8</b> To show the coordinates, press the [F3](NEZ) key. *3),4)</p>	<p>[F3]</p>	<pre> PLANE OFFSET N :      17.321 m E :      10.000 m Z :      20.000 m NEXT SD HD REC                     </pre>

- \*1) In case the calculation of plane was not successful by the measured three points, error displays. Start measuring over again from the first point.
- \*2) Error will be displayed when collimated to the direction which does not cross with the determined plane.
- \*3) The reflector height of the target point P<sub>0</sub> is set to zero automatically.
- \*4) To repeat the offset measurement, press the [F1](NEXT) key. The display will return to step 4.

### 5.6.4 Column Offset Measurement

If it is possible to measure circumscription point (P1) of column directly, the distance to the center of the column (P0), coordinate and direction angle can be calculated by measured circumscription points (P2) and (P3).

The direction angle of the center of the column is 1/2 of total direction angle of circumscription points (P2) and (P3).

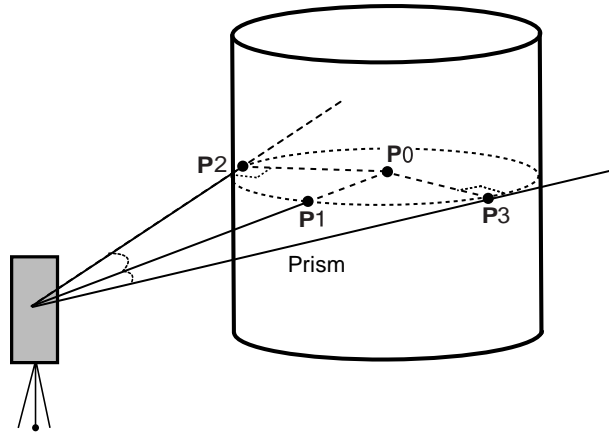

Operating procedure	Operation	Display
<p><b>1</b> Press [F6](MORE) key from programs menu to get to the next page of programs.</p> <p><b>2</b> Press [F2](OFFSET) key.</p> <p><b>3</b> Press [F4](COLUMN OFFSET) key.</p> <p>Measurement screen of the center of a column will be shown.</p> <p><b>4</b> Collimate the center of the column (P1) and press the [F1](MEAS) key. Measuring will start. After the measurement, angle measuring display of the left side (P2) will be shown.</p>	[F6]	<pre> Programs ----- F1 BS      p                4/7 F2 STORE  p F3 REM    p F4 MLM    p                MORE                     </pre>
	[F2]	<pre> Programs ----- F1 LINE    p                7/7 F2 OFFSET  p F3 EXT.LINK p                MORE                     </pre>
	[F4]	<pre> OFFSET MEASUREMENT 1.ANGLE OFFSET 2.DIST. OFFSET 3.PLANE OFFSET 4.COLUMN OFFSET                     </pre>
	Collimate P1 [F1]	<pre> COLUMN OFFSET Center HD :                m  MEAS                HT                     </pre>
		<pre> COLUMN OFFSET Left HR :    90°30'40"  SET                     </pre>

<p><b>5</b> Collimate the left side of the column (P2) and press the [F6](SET) key.</p> <p>After the measurement, angle measuring display of the right side (P3) will be shown.</p>	<p>Collimate P2 [F6]</p>	<pre> COLUMN OFFSET Right HR : 95°30'40"  SET </pre>
<p><b>6</b> Collimate the right side of the column (P3) and press the [F6](SET) key.</p> <p>After the measurement, the distance between the instrument and center of the column (P0) will be calculated and displayed.</p>	<p>Collimate P3 [F6]</p>	<pre> COLUMN OFFSET HR: 90°30'40" HD: 10.321 m VD: 0.886 m NEXT SD NEZ REC </pre>
<p><b>7</b> To show the slope distance of point P0, press the [F2](SD) key.</p>	<p>[F2]</p>	<pre> COLUMN OFFSET V : 85°30'30" HR: 90°30'40" SD: 10.999 m NEXT HD NEZ REC </pre>
<p><b>8</b> To show the coordinates, press the [F3](NEZ) key. *1)</p>	<p>[F3]</p>	<pre> COLUMN OFFSET N : 17.321 m E : 10.962 m Z : 0.886 m NEXT SD HD REC </pre>
<p>*1) To repeat the offset measurement, press the [F1](NEXT) key. The display will return to step 4.</p>		



## 5.7 External Link

You can use compatible communication command of AP-L1A for GTS-820A series. In this process carry out setting for remote control system RC-2II using together.

### 5.7.1 Starting compatible communication program of AP-L1A

Operating procedure	Operation	Display
<b>1</b> Press the [F6](MORE) key to get the next page.	[F6]	Programs F1 BS            p                    4/7 F2 STORE       p F3 REM           p F4 MLM          p                    MORE
		Programs F1 LINE         P                    7/7 F2 OFF SET     P F3 EXT.LINK   P <div style="text-align: right;">MORE</div>
<b>2</b> Press the [F3](EXT.LINK) key. The compatible program EXTERNAL LINK will start.	[F3]	EXTERNAL LINK 1 Execute 2 Setting

### 5.7.2 Setting for the communication

Decide transmit course and parameters before executing communication.

#### (1)Setting communication course

Select a communication course according to the using optional device.

- 1) Cable        : In case connecting personal computer or other than Topcon's designated wireless modem to the RS-232C connector.
- 2) RADIO MODEM : In case connecting Topcon's designated wireless modem.
- 3) RC            : In case carrying out optical communication using with the remote controller system RC-2II.

Operating procedure	Operation	Display
Execute Section 5.7.1"Starting compatible communication program of AP-L1A" to start [EXT.LINK] of compatible communication program of AP-L1.		EXTERNAL LINK 1 Execute 2 Setting
<b>1</b> Press the [F2](Setting) key.	[F2]	Setting 1 CABLE/RADIO MODEM/RC 2 PARAMETER (CABLE) 3 PARAMETER (RC) 4 PARAMETER (RADIO MODEM)
<b>2</b> Press the [F1] key to select [CABLE/RADIO MODEM/RC]	[F1]	CABLE/RADIO MODEM/RC <div style="text-align: center;">CABLE</div> SET            ↑            ↓            EXIT

<p><b>3</b> Select communication course by pressing the [F3](↑) or [F4](↓) key. (Sample setting :RC)</p>	<p>[F3] or [F4]</p>	<div style="border: 1px solid black; padding: 5px; text-align: center;"> <p>CABLE/RADIO MODEM/RC</p> <p>RC</p> <p>SET      ↑      ↓      EXIT</p> </div>
<p><b>4</b> Press the [F1](SET) key to decide.</p>	<p>[F4]</p>	<div style="border: 1px solid black; padding: 5px;"> <p>Setting</p> <p>1 CABLE/RADIO MODEM/RC</p> <p>2 PARAMETER (CABLE)</p> <p>3 PARAMETER (RC)</p> <p>4 PARAMETER (RADIO MODEM)</p> </div>
<p>1 To cancel the setting, press the [F6](EXIT)key or the [ESC] key.</p>		

**(2)Setting Parameters of Cable (RS-232C)**

In case connecting Topcon's designated wireless modem, simply select communication course as "RADIO MODEM" it is enough to do setting of parameter automatically.

In case connecting personal computer or other than Topcon's designated wireless modem, it is required to do parameters setting for RS-232C before using.

**Parameters**

1) SPEED (Baud rate)

Sets communication speed  
Set items: 1200, 2400, 4800, 9600bps

2) BIT FORMAT

Select the communication format.  
Set items:  
Bit length           :    7 : D7,    8 : D8  
Stop bit             :    1 : S1,    2 : S2  
Parity bit            :    NONE, ODD, EVEN

3) DELIMITER (Terminate)

Selecting CR (Carriage return), or LF (Line feed) will be added at the end of data.  
Set items:  
ETX, ETX+CR, ETX+CRLF

4) RTS (Control of signal line)

Select default output of signal line  
Set items:  
Hi            : High level (Normal)  
Low           : Low level (It becomes High level only when data are transmitted.)

5) REC TYPE

Select the option to record the data for the distance measurement.  
REC-A : Measure the distance again and record the updated distance.  
REC-B : Record the data for the last distance measurement on the display.

Operating procedure	Operation	Display
<p>Execute Section 5.7.1"Starting compatible communication program of AP-L1A" to start [EXT.LINK] of compatible communication program of AP-L1.</p> <p><b>1</b> Press the [F2](Setting) key.</p>	<p>[F2]</p>	<div style="border: 1px solid black; padding: 5px;"> <p>EXTERNAL LINK</p> <p>1 Execute</p> <p>2 Setting</p> </div> <div style="border: 1px solid black; padding: 5px; margin-top: 5px;"> <p>Setting</p> <p>1 CABLE/RADIO MODEM/RC</p> <p>2 PARAMETER (CABLE)</p> <p>3 PARAMETER (RC)</p> <p>4 PARAMETER (RADIO MODEM)</p> </div>

<p><b>2</b> Press the [F2] key to select [2PARAMETER (CABLE)]. Speed setting screen will appear.</p>	<p>[F2]</p>	<pre> SPEED           9600 SET      ↑      ↓      EXIT         </pre>
<p><b>3</b> Press the [F3](↑) or [F4](↓) key to select baud rate then press the [F1](SET) key to decide.</p>	<p>[F3] or [F4] [F1]</p>	<pre> BIT FORMAT           D8  S1  NONE SET      ↑      ↓      EXIT         </pre>
<p><b>4</b> Set bit format in the same way.</p>	<p>[F3] or [F4] [F1]</p>	<pre> TERMINATE           ETX SET      ↑      ↓      EXIT         </pre>
<p><b>5</b> Set DELIMITER (Terminate) in the same way.</p>	<p>[F3] or [F4] [F1]</p>	<pre> RTS           Hi SET      ↑      ↓      EXIT         </pre>
<p><b>6</b> Set RTS in the same way. <b>7</b> Set REC TYPE in the same way.</p>	<p>[F3] or [F4] [F1]</p>	<pre> REC TYPE           REC-A SET      ↑      ↓      EXIT         </pre>
<pre> Setting 1  CABLE/RADIO MODEM/RC 2  PARAMETER (CABLE) 3  PARAMETER (RC) 4  PARAMETER (RADIO MODEM)         </pre>		
<p>1 To cancel the setting, press the [F6](EXIT)key or the [ESC] key.</p>		

**(3)Setting Parameters of RC**

Set the parameters for communication with remote controller system.

**Parameters**

- 1) Channel  
Sets communication channel  
The same channel must be set for GTS-820A series and RC-2RII.  
Set channels : 1, 2, 3
- 2) DELIMITER (Terminate)  
Selecting CR (Carriage return), or LF (Line feed) will be added at the end of data.  
Set items:  
ETX, ETX+CR, ETX+CRLF
- 3) Retry  
This is a method to retry setting for sending data during communication with remote controller RC-2RII.  
Set items:  
Standard, Divided  
Standard: Gives good for fast communication.  
This is offered in normal condition.  
Divided: Using in bad condition such in long distance, bad condition of sight, strong

heat simmer, or happens cut off the optical path, in such cases it takes long time for communication or results failure. You are offered to set [Divided] item.

4) REC TYPE

Select the option to record the data for the distance measurement.

REC-A : Measure the distance again and record the updated distance.

REC-B : Record the data for the last distance measurement on the display.

Operating procedure	Operation	Display
<p>Execute Section 5.7.1“Starting compatible communication program of AP-L1A” to start [EXT.LINK] of compatible communication program of AP-L1.</p>		<pre>EXTERNAL LINK  1 Execute  2 Setting</pre>
<p>1 Press the [F2](Setting) key.</p>	[F2]	<pre>Setting  1 CABLE/RADIO MODEM/RC  2 PARAMETER (CABLE)  3 PARAMETER (RC)  4 PARAMETER (RADIO MODEM)</pre>
<p>2 Press the [F3] key to select [3 PARAMETER (RC)].</p>	[F3]	<pre>CHANNEL            1  SET      ↑      ↓      EXIT</pre>
<p>3 Select a channel by pressing the [F3](↑) or [F4](↓) key then press the [F1](SET) key.</p>	[F3] or [F4] [F1]	<pre>TERMINATE            ETX  SET      ↑      ↓      EXIT</pre>
<p>4 Select Terminate by pressing the [F3](↑) or [F4](↓) key then press the [F1](SET) key.</p>	[F3] or [F4] [F1]	<pre>RETRY            Standard  SET      ↑      ↓      EXIT</pre>
<p>5 Select Retry by pressing the [F3](↑) or [F4](↓) key then press the [F1](SET) key</p>	[F3] or [F4] [F1]	<pre>REC TYPE            REC-A  SET      ↑      ↓      EXIT</pre>
<p>6 Set REC TYPE in the same way.</p>	[F3] or [F4] [F1]	<pre>Setting  1 CABLE/RADIO MODEM/RC  2 PARAMETER (CABLE)  3 PARAMETER (RC)  4 PARAMETER (RADIO MODEM)</pre>
<p>1 To cancel the setting, press the [F6](EXIT)key or the [ESC] key.</p>		

**(4)Setting Parameters for Radio Modem**

Set the parameters for Radio Modem.

**Parameters**

1) Channel (Only for certain market)

Sets communication channel

The same channel must be set for GTS-820A series and Radio Modem.

Set channels : A, B, C.....

2) REC TYPE

Select the option to record the data for the distance measurement.

REC-A : Measure the distance again and record the updated distance.

REC-B : Record the data for the last distance measurement on the display.

Operating procedure	Operation	Display
<p>Execute Section 5.7.1“Starting compatible communication program of AP-L1A” to start [EXT.LINK] of compatible communication program of AP-L1.</p> <p><b>1</b> Press the [F2](Setting) key.</p> <p><b>2</b> Press the [F4] key to select PARAMETER (RADIO MODEM). <b>(The channel setting display is provided only for certain market)</b></p> <p><b>3</b> Set REC TYPE in the same way.</p>	<p>[F2]</p> <p>[F3] or [F4] [F1]</p> <p>[F3] or [F4] [F1]</p>	<p>EXTERNAL LINK</p> <p>1 Execute</p> <p>2 Setting</p>
		<p>Setting</p> <p>1 CABLE/RADIO MODEM/RC</p> <p>2 PARAMETER (CABLE)</p> <p>3 PARAMETER (RC)</p> <p>4 PARAMETER (RADIO MODEM)</p>
		<p>CHANNEL</p> <p style="text-align: center;">A</p> <p>SET     ↑     ↓     EXIT</p>
		<p>REC TYPE</p> <p style="text-align: center;">REC-A</p> <p>SET     ↑     ↓     EXIT</p>
		<p>Setting</p> <p>1 CABLE/RADIO MODEM/RC</p> <p>2 PARAMETER (CABLE)</p> <p>3 PARAMETER (RC)</p> <p>4 PARAMETER (RADIO MODEM)</p>

5.7.3 Carrying out Communication

Operating procedure	Operation	Display
<p>Execute Section 5.7.1“Starting compatible communication program of AP-L1A” to start [EXT.LINK] of compatible communication program of AP-L1.</p> <p><b>1</b> Press the [F1](Execute) key. The display as showing right says the compatible communication program of AP-L1A is executed and communication command can be accepted.</p>	<p>[F1]</p>	<p>EXTERNAL LINK</p> <p>1 Execute</p> <p>2 Setting</p>
		<p>EXTERNAL LINK (RC)</p> <p>Remote control is being done from the controller.</p> <p style="text-align: right;">EXIT</p>
<p><b>1</b> To stop the communication, press the [F6](EXIT) or [ESC] key.</p>		

# 6 MEMORY MANAGE MODES

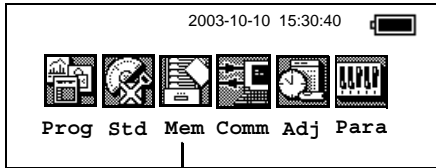

[Press [F3] key.]

## MEMORY MANAGE MODES

The following items are available in this mode.

1. Display the memory size and memory free.
2. Protecting files
3. Delete files
4. Rename files
5. Copy files
6. Initialize memory.

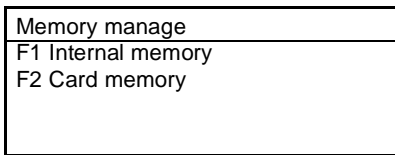

### 6.1 View Internal Memory and Card Memory Status

When selecting the internal memory or card memory, the GTS-820 will display the memory size, the amount of free memory and the expiration date for the internal lithium battery.

The display information format is the same for the card memory except that the card name appears at the top of the display. The card name can be eleven characters in length, alpha or numeric.

Operating procedure	Operation	Display
<p><b>1</b> Select Internal memory or Card memory by pressing [F1] or [F2] key. The memory capacity and the remaining memory capacity are shown. Example: Internal Memory</p>		
		<p><b>2</b> Press [F6](File) key. Each File status (File name, File name extension, Used memory capacity, Date) are shown. Press the [ESC] key to return to the main menu icons.</p>

## 6.2 Protect a File

Protecting one or more files can be accomplished with the file protection mode. When a file is protected, an asterisk appears after the file name extension. If a file is protected, you can not delete the file unless you remove the file protection.

1 Note: All the files stored will be erased by initializing the memory, even if the files are protected.

Operating procedure	Operation	Display
1 Proceed Chapter 6.1.		<pre>JIS   .DAT   1597  12-25 TOPCON .DAT   1089  10-05 FC7   .TXT   2450  09-11 HILL  .DAT   31777  08-19 Pro   Ren   Del   Copy  ↑  ↓</pre>
2 Select a file using [F5](↑) key or [F6](↓) key.	Select a file	
3 Press [F1](Pro) key.	[F1]	<pre>Protect  [ TOPCON  .DAT ]                                  ON  OFF</pre>
4 Press [F5](ON) key. *1) The file is protected and display will return to file name.	[F5]	
*1) When you cancel the protection, repeat the procedure above mentioned and select [F6](OFF) key.		

## 6.3 Rename a File

Files can be renamed on the card or in internal memory. When renaming a file, the old file name appears above the input line for the new file name. When typing in the new name, you do not have to input the file extension.

Operating procedure	Operation	Display
1 Proceed Chapter 6.1.		<pre>JIS   .DAT   1597  12-25 TOPCON .DAT   1089  10-05 FC7   .TXT   2450  09-11 HILL  .DAT   31777  08-19 Pro   Ren   Del   Copy  ↑  ↓</pre>
2 Select a file using [F5](↑) key or [F6](↓) key.	Select a file	
3 Press [F2](Ren) key.	[F2]	<pre>Rename Old name [ TOPCON  .DAT ] New name [           ]  Alpha  SPC  ←  →</pre>
4 Enter a new file name within 8 characters. Press [ENT] key. *1)	Enter name  [ENT]	
*1) Refer to Chapter 2.9 "How to Enter Numerals and Alphabet Letters".		

## 6.4 Deleting a File

The delete mode erases a file from internal memory or the card memory. If a file is protected, the file can not be erased. File protection must be removed before you can delete a file. Only one file can be erased at a time .

Operating procedure	Operation	Display
1 Proceed Chapter 6.1.		<pre>JIS   .DAT   1597  12-25 TOPCON .DAT   1089  10-05 FC7   .TXT   2450  09-11 HILL  .DAT   31777  08-19 Pro   Ren   Del   Copy  ↑  ↓</pre>
2 Select a file using [F5](↑) key or [F6](↓) key.	Select a file	
3 Press [F3](Del) key.	[F3]	<pre>Delete  [ TOPCON  .DAT ]                                 YES  NO</pre>
4 Confirm the file name, and press [F5](YES) key.	[F5]	
1 If the file is protected, the file can not be erased. Erase the file after canceling the protection.		

## 6.5 Copy a File

A file can be copied from internal memory to the card memory and vice verse. The copy mode only copies files to the root directory. Files can not be copied into other directories.

Example : Copying a file in internal memory to card memory.

Operating procedure	Operation	Display
1 Press [F1] key to choose Internal memory.	[F1]	<pre>MEMORY manage F1 Internal memory F2 Card memory</pre>
2 Select a file using [F5](↑) key or [F6](↓) key.	Select a file	
3 Press [F4](Copy) key.	[F4]	<pre>File Copy  [HILL  .DAT ]                                 YES  NO</pre>
4 Confirm the file name, and press [F5](YES) key.	[F5]	



## 6.6 Initializing Memory

The initialize memory option will erase **ALL FILES** in either the internal memory or card memory and files cannot be retrieved.

Example: Initializing card memory

Operating procedure	Operation	Display
<b>1</b> Press [F2] key to select card memory.	[F2]	<pre> MEMORY manage F1 Internal memory F2 Card memory           </pre>
		<pre> Card name [TOPCON      ] Memory size      1967KByte Memory free      1951KByte Card battery expire  11/99 Init              File           </pre>
<b>2</b> Press [F1](Init) key.	[F1]	<pre> RAM card memory format                                  YES  NO           </pre>
<b>3</b> Confirm the display, and press [F5](YES) key. Initializing will be executed.	[F5]	<pre> Card name        [          ]  Alpha SPC  ←  →           </pre>
<b>4</b> Input card name and press [ENT] key.  Card memory expire will be shown.	Card name [ENT]	<pre> Card memory expire Today              2003-11 Validity           +4.0 year Until              2007-11                                 YES  NO           </pre>
<b>5</b> Confirm the display, and press [F5](YES) key. *1)	[F5]	
The display returns to main menu.		
*1) To reset the card memory expire, press [F6] (NO) key and input new data.		

# 7 COMMUNICATION MODES

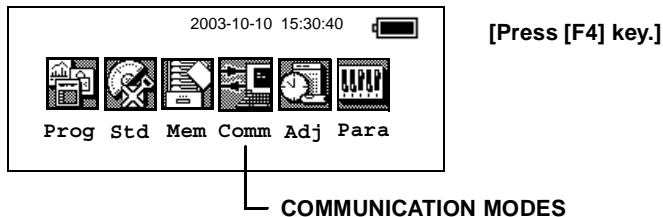

The communication modes are used for setting the Baud rate (Protocol), receiving a file (Data file in) and sending a file (Data file out). A data transfer program on your PC that supports (YMODEM) will be necessary to send or receive data files.

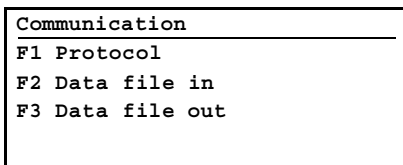

## 7.1 Setting of PROTOCOL

To transfer data files to and from the GTS-820A Series and PC, the Baud rates must be the same. The Baud rate selections are 600, 1200, 2400, 4800, 9600, and 19200.

To set the protocol for measured data transferring, refer to Chapter 8 "PARAMETERS SETTING MODE" ..

Operating procedure	Operation	Display
<b>1</b> Press the [F1](Protocol) key for protocol.	[F1]	
<b>2</b> To select the Baud rate, use the arrow key's [F3-F6] to highlight your choice. When the correct Baud rate is highlighted, press the [ENT] key.	[F3] to[F6]  [ENT]	

## 7.2 Data File In

When transferring data files from a PC to the GTS-820A Series, the file received into the main directory. Data files CANNOT be received into a subdirectory. Data files CANNOT be transferred to the card memory. Files can only be transferred to the internal memory and then copied onto the card.

Operating procedure	Operation	Display
<p>Make sure the instrument is ready and waiting for the data file before you command the PC to send the file.</p> <p><b>1</b> Press [F2](Data file in) key.  <b>2</b> Command the PC to send the file at this time. File name, amount of received data (Byte) / Capacity of the file (Byte) and percentage of proceeding will be displayed. When the transfer is complete, the display will return to the main menu icons.</p>	[F2]	<div style="border: 1px solid black; padding: 5px;"> <p>Communication</p> <hr/> <p>F1 Protocol  F2 Data file in  F3 Data file out</p> </div> <div style="border: 1px solid black; padding: 5px; margin-top: 5px;"> <p>Data file in</p> <hr/> <p style="text-align: center;">[TOPCON .DAT]</p> <p style="text-align: center;">0/ 8676 (0%)</p> </div>

## 7.3 Data File Out

Transferring a file from the GTS-820A internal memory or card memory to the PC is also possible.

Operating procedure	Operation	Display																									
<p>Make sure the PC is ready and waiting before the GTS-820 sends the file.</p> <p><b>1</b> Press [F3](Data file out) key.</p> <p><b>2</b> Press [F1](Internal memory) or [F2](Card memory) key and press [ENT] key. Example: Internal memory</p> <p><b>3</b> Select a file by pressing [F5](↑) or [F6](↓) key and press [ENT] key. File name, amount of sent data(Byte) / Capacity of the file (Byte) and percentage of proceeding will be displayed. When the transfer is complete, the display will return to the file menu.</p>	<p>[F3]</p> <p>[F1] to[F2] [ENT]</p> <p>Select a file [ENT]</p>	<div style="border: 1px solid black; padding: 5px;"> <p>Communication</p> <hr/> <p>F1 Protocol  F2 Data file in  F3 Data file out</p> </div> <div style="border: 1px solid black; padding: 5px; margin-top: 5px;"> <p>Data file out</p> <hr/> <p>F1 Internal memory  F2 Card memory</p> </div> <div style="border: 1px solid black; padding: 5px; margin-top: 5px;"> <table style="width: 100%; border-collapse: collapse;"> <tr> <td style="width: 20%;">JIS</td> <td style="width: 10%;">.DAT</td> <td style="width: 10%;">1597</td> <td style="width: 10%;">12-25</td> <td style="width: 50%;"></td> </tr> <tr> <td>TOPCON</td> <td>.DAT</td> <td>1089</td> <td>10-05</td> <td></td> </tr> <tr> <td>FC7</td> <td>.TXT</td> <td>2450</td> <td>09-11</td> <td></td> </tr> <tr> <td>HILL</td> <td>.DAT</td> <td>31777</td> <td>08-19</td> <td></td> </tr> <tr> <td colspan="4">Data file out</td> <td style="text-align: center;">↑ ↓</td> </tr> </table> </div> <div style="border: 1px solid black; padding: 5px; margin-top: 5px;"> <p>Data file out</p> <hr/> <p style="text-align: center;">[TOPCON .DAT]</p> <p style="text-align: center;">0/ 1089 (0%)</p> </div>	JIS	.DAT	1597	12-25		TOPCON	.DAT	1089	10-05		FC7	.TXT	2450	09-11		HILL	.DAT	31777	08-19		Data file out				↑ ↓
JIS	.DAT	1597	12-25																								
TOPCON	.DAT	1089	10-05																								
FC7	.TXT	2450	09-11																								
HILL	.DAT	31777	08-19																								
Data file out				↑ ↓																							

## 8 PARAMETERS SETTING MODE

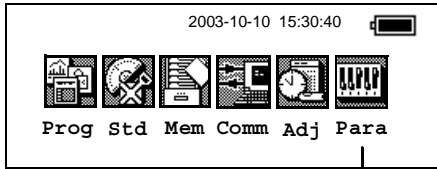

[Press [F6] key.]

### PARAMETERS SETTING MODE

In this mode, setting of parameters regard with measuring, displaying and communications will be done.

When a parameter is changed and set, the new value is stored into memory.

Press [F6] key from the main menu icons, the following display will be shown.

The parameter modes is classified in Measurement and Communication.

Parameters
F1 Measurement
F2 Communication
F3 Password

### 8.1 Parameter Setting Options

#### 8.1.1 Parameters for Measurement and Display

Menu	Selecting Item	Contents
Ang. Unit	deg / gon / mil	Select degree(360°), gon(400G) or mil (6400M) for the measuring angle unit to be shown on the display.
Min.Angle	OFF / ON	Select the minimum display angle reading ON or OFF. GTS-821A [ OFF:1" / ON:0.5" ] GTS-822A [ OFF:1" / ON:0.5" ] GTS-823A [ OFF:5" / ON:1" ] GTS-825A [ OFF:5" / ON:1" ]
Tilt	OFF / 1axis / 2axes	Select the tilt sensor option for OFF, (1axis) vertical only or (2axes) vertical and horizontal.
Err. corr.	OFF / ON	Select the error correction ON or OFF for collimation and error adjustment. <b>Note:</b> Perform this item after complete section 9.4. For more information, refer to Section 9.4 "Adjustment of Compensation Systematic Error of Instrument" and Section 9.5 "Showing Constant List and Switch ON/OFF Compensation Systematic Error of Instrument".
V-0	Zenith / Level	Select the vertical angle reading for Zenith 0 or Horizontal 0.
HAmem	OFF / MEM. ON	It is able to retain presetting angle after turning power off.(MEMORY) <b>Note:</b> After changing this parameter, turn the power switch off once.
Turn	Fine / Normal / Coarse	Select the stopping accuracy of automatic rotation to required angle. Fine:3"      Normal :5"      Coarse:10"
Auto.Aim	Fine / Normal / Coarse	Select the accuracy of automatic collimation.

Dist. Unit	METER /FEET	Select the distance measuring unit Meter or Feet shown on the display.
C.F. m/ft	Us.f /Intl.f	Select the meter / feet conversion factor. US SURVEY feet 1m =3.2808333333333333 ft. INTERNATIONAL feet 1m =3.280839895013123 ft.
Min. Dist.	OFF / ON	Select OFF or ON for the minimum distance in fine mode. OFF:1mm :ON: 0.2mm
S/A buzz.	OFF / ON	Select the Audio tone OFF or ON for the Set Audio Mode.
W-corr.	OFF/ 0.14 / 0.20	Select the coefficient correction for refraction and earth curvature. Selections for the refraction coefficient are; OFF (No correction), K=0.14 or K=0.20.
N/E/Z mem	OFF / MEM.ON	Select the option to store the coordinates (NEZ) for the occupied point when power is turned off.
N/E- ord.	NEZ / ENZ	Select the display format in the coordinate measurement mode for NEZ or ENZ.
Temp. Unit	°C / °F	Select the temperature unit for the atmospheric correction.
Pres. Unit	mmHg/inHg/hPa	Select the air pressure unit for the atmospheric correction .
R/L Lock	OFF / ON	Prohibit switching angle right or left by soft key in angle measurement mode OFF : Switching is possible ON : Prohibition
m/ft Lock	OFF / ON	Prohibit switching meter unit or feet unit. OFF : Switching is possible ON : Prohibition
Date	d / m / y m / d / y y / m / d	Select the date format shown on the display. (Month / Date / Year) , (Date/Month/ Year) or (Year / Month / Date)
A. P. OFF	OFF / ON (01 to 99)	The auto power off function can be turned OFF or set ON. OFF : not use ON :1 to 99 minutes (numeric key)
Heater	OFF / ON	The heater option for both display units can be turned OFF or ON.
EDM wait	OFF / ON (01 to 99)	EDM cut off time after distance measurement is completed can be changed. OFF : EDM is cut off immediately after measuring ON : EDM is cut off after 1 to 99 minutes.
Ini. mode	Menu / Std / E.Link	Select the initial mode when powering on. Menu : Menu Std : Standard measurement E.Link : External link
Self chk	OFF / ON	Select the self check function ON or OFF when powering on.

### 8.1.2 Parameters for communication

The following settings are effective for standard measurement modes only.  
You are requested to set each time of each application such as EXTERNAL LINK (in Program modes) or other application software.

#### Serial port.

Menu	Selecting Item	Contents
S.Port	<b>RS232C</b> /RC	Selecting serial port, RS-232C connector 1(6pins) or Remote controll system.

#### Setting parameters for RS232C

Menu	Selecting Item	Contents
B. Rate	<b>1200</b> / 2400 / 4800 / 9600	Select the baud rate.
Data. L	<b>7</b> / 8	Select the data length seven digits or eight digits.
Parity	none / odd / <b>even</b>	Select the parity bit.
Stop Bit	<b>1</b> / 2	Select the stop bit.
Delimit	<b>ETX</b> / CRLF	Select the option OFF or ON for carriage return and line feed when collecting measurement data with a computer.
REC-A/B	<b>A</b> / B	Select the option to record the data. REC-A : The measurement is started and new data is output REC-B : The data being displayed is output.
Protocol	OFF / <b>ON</b>	When communicating to an external device, the protocol for handshaking can omit the [ACK] coming from the external device so data is not sent again. OFF : Omit the [ACK] ON : Standard
NEZ-REC	<b>Std</b> / Exp	Record coordinates in standard or Data with slope distance and horizontal angle data.
Trk Stat	<b>OFF</b> / ON	Selecting additional information of utility to measuring data such as tracking status or not. If such utility is selected, electric circular level graphic will not be displayed whenever tilted over. OFF :No additional information ON :Additional information

#### Setting parameter for RC

Menu	Selecting Item	Contents
Channel	<b>1</b> / 2 / 3	Sets communication channel when using with remote controll system.
V.Search	<b>15</b> / 30	Selecting the vertical range for searching a prism when using with remote controll system. 15 : $\pm 15^\circ$ 30 : $\pm 30^\circ$
RC	<b>S</b> / M	Selecting the number of the RC-2R11 to use one or more than one when using with RC-2R11. S : Single RC-2R11 use M : Multiple RC-2R11 use

Retry	<b>Std.</b> / Div.	Selecting the method of the data re-transmitting. Std (Standard) : This is offered in normal condition. Div.(Divided) : Using in bad condition such in long distance, bad condition of sight, strong heat simmer.
Delimit	<b>ETX</b> / CRLF	Select the option OFF or ON for carriage return and line feed when collecting measurement data with a computer.
REC-A/B	<b>A</b> / B	Select the option to record the data. REC-A :The measurement is started and new data is output. REC-B :The data being displayed is output.
NEZ-REC	<b>Std</b> / Exp	Record coordinates in standard or Data with slope distance and horizontal angle data.
Trk State	<b>OFF</b> / ON	Selecting additional information of utility to measuring data such as tracking status or not. If such utility is selected, electric circular level graphic will not be displayed whenever tilted over. OFF :No additional information ON :Additional information
B. Rate	4800	Fixed
Data. L	8	Fixed
Parity	none	Fixed
Stop Bit	1	Fixed

## 8.2 Setting Parameters

### 8.2.1 Parameters for Measurement and Display

[Example setting] S/A BUZZER: OFF, Atmospheric pressure: hPa

Operating procedure	Operation	Display
1 Press the [F6] key from the main menu icons.	[F6]	<pre>Parameters ----- F1 Measurement F2 Communication F3 Password</pre>
2 Press the [F1] (Measurement) key.	[F1]	<pre>Parameters (Measurement) ----- Ang.Unit [ deg ] gon mil Min.Angl OFF [ ON ] Tilt [ OFF ] laxis 2axis SET EXIT &lt;- -&gt; ↑ ↓</pre>
3 Select the menu by pressing [F6](↓) key. (Example: S/A buzz.)	[F6]	<pre>Parameters (Measurement) ----- S/A buzz. OFF [ ON ] W-corr. OFF [ 0.14 ] 0.20 N/E/Z mem OFF [ ON ] SET EXIT &lt;- -&gt; ↑ ↓</pre>
4 Press [F3](←) key, and select OFF.	[F3]	<pre>Parameters (Measurement) ----- S/A buzz. [ OFF ] ON W-corr. OFF [ 0.14 ] 0.20 N/E/Z mem OFF [ ON ] SET EXIT &lt;- -&gt; ↑ ↓</pre>
5 Select the atmospheric pressure menu by pressing [F6](↓) key.	[F6]	<pre>Parameters (Measurement) ----- Pres.Unit [ mmHg ] inHg hPa R/L Lock [ OFF ] ON m/ftLock [ OFF ] ON SET EXIT &lt;- -&gt; ↑ ↓</pre>
6 Press [F4](→) key twice, and select hPa.	[F4]	<pre>Parameters (Measurement) ----- Pres.Uni mmHg inHg [hPa ] R/L Lock [ OFF ] ON m/ftLock [ OFF ] ON SET EXIT &lt;- -&gt; ↑ ↓</pre>
7 Press [F1](SET) key.	[F1]	<pre>Parameters (Measurement) ----- &gt; Set OK?  YES NO</pre>
8 Press [F5](YES) key. *1) The display returns main menu.	[F5]	

\*1) To cancel the setting, press [F6](NO) key.



## 8.2.2 Parameters for Communication

Sample setting: RS232C

Operating procedure	Operation	Display
1 Press the [F6] key from the main menu icons.	[F6]	<pre>Parameters ----- F1 Measurement F2 Communication F3 Password</pre>
2 Press the [F2] (Communication) key. The screen in the right is indicated.	[F2]	<pre>Parameters (Communication) ----- 1 Serial Port RS232C/RC 2 Set RS232C 3 Set RC</pre>
3 Press the [F2](Set RS232C) key. The next steps are same as Section 8.2.1- Parameters Setting for communication, refer to the section 8.2.1.	[F2]	<pre>Parameters (Communication) ----- B.Rate [1200] 2400 4800 9600 Data.L [ 7 ] 8 Parity none odd [even] SET I.GTS &lt;- -&gt; ↑ ↓</pre>
<p>1 The setting will reset to the default settings by pressing the [F2](I.GTS) key. (1200baudrate, Even, Stop 1, Delimit ETX, Rec-A Protocol ON, NEZ-REC Standard) Factory default settings are indicated with underlines in Chapter 8.1.2 "Parameters for communication".</p> <p>1 In the setting of RC, the settings of Baudrate, data length, Parity and Stop are fixed. They will be indicated on the screen for your reference. Though Protocol is not indicated, it is fixed to OFF.</p>		

## 8.2.3 Password Option

### Establishing a Password

A password can be set in the GTS-820A series to secure the use of the instrument. Once a password is established the user can disable the option or change the password. Once a password established and the option is turned off, the password will always remain in memory. When turning on the instrument after a password-input screen appears before the self-test mode. Type in your password and press the [ENTER] to continue.

A maximum of 10 numeric digits can be entered for a password. All zeros (0000000000) or 9's (9999999999) are invalid passwords. If 10 unsuccessful attempts are made to input a password, the instrument will shut off automatically.

### Establishing a Password for the first time.

The instructions below show how to establish a password for the first time .

Operating procedure	Operation	Display
1 From the main menu icons, press [F6](Para) to access the parameters option menu. To access the password option, press [F3](Password).	[F6]	<pre>Parameters ----- F1 Measurement F2 Communication F3 Password</pre>
	[F3]	<pre>Password [OFF]  EXIT CHANGE          ON OFF</pre>

<p><b>2</b> The password option screen will appear. When accessing the password option for the first time, the [OFF] indicator will appear on the upper left corner of the screen. To establish a password you can press the [F5](ON) key to turn on the option and establish a password.</p>	[F5]	<pre> Password Input a password [           ] EXIT                               BS             </pre>
<p><b>3</b> The password-input screen will appear. At the blinking cursor type in your password and press the [ENT] key.</p> <p><b>IMPORTANT: DON'T FORGET YOUR PASSWORD. WRITE THE PASSWORD DOWN ON A PIECE OF PAPER AND PUT IN A SAFE PLACE. ONCE A PASSWORD IS STORED YOU CAN NOT ERASE IT FROM MEMORY.</b></p>	Type password [ENT]	<pre> Password Input again (confirmation) [           ] EXIT                               BS             </pre>
<p><b>4</b> The confirmation screen will appear to confirm your password. Type the password in once again and press [ENT].</p>	Type password [ENT]	<pre> Password [ON] EXIT CHANGE                       ON OFF             </pre>
<p><b>5</b> The password option screen will appear once again for 2 seconds and will automatically change to the main menu icons. Notice the [ON] indicator is now shown on the display.</p>		

**Turning OFF the Password**

After a password is established, you can disable the password option. Once you disable the option, the password-input screen will not appear every time you power on the instrument.

**Turning OFF the Password Option**

Operating procedure	Operation	Display
<p><b>1</b> From the main menu icons, press [F6](Para) to access the parameters option menu. Press [F3](Password) to access the password option.</p>	[F6]	<pre> Parameters ----- F1 Measurement F2 Communication F3 Password             </pre>
	[F3]	<pre> Password Input a password [           ] EXIT                               BS             </pre>
<p><b>2</b> Type in your password and press [ENT].</p>	Type password [ENT]	<pre> Password [ON] EXIT CHANGE                       ON OFF             </pre>
<p><b>3</b> The password option screen will appear. The indicator on the upper left side of the screen will show [ON].</p>		

<p>4 To turn off the password option, press [F6](OFF). The [ON] indication changes to [OFF] and the screen automatically changes back to the main menu icons.</p>	[F6]	<div style="border: 1px solid black; padding: 5px;"> <p>Password [OFF]</p> <p>EXIT CHANGE                      ON OFF</p> </div>
---	------	--

### Changing a Password

Once a password is established, you can change the original password. The new password takes the place of the original password in memory.

### Changing the Password

Operating procedure	Operation	Display
<p>1 From the main menu icons, press [F6](Para) to access the parameters option menu. Press [F3](Password) to access the password option.</p>	[F6]	<div style="border: 1px solid black; padding: 5px;"> <p>Parameters</p> <hr/> <p>F1 Measurement F2 Communication F3 Password</p> </div>
<p>2 Type in your password at the blinking cursor and press [ENT].</p>	[F3]	<div style="border: 1px solid black; padding: 5px;"> <p>Password Input a password [                      ]</p> <p>EXIT                                      BS</p> </div>
<p>3 The password option screen will appear. Press the [F2](Change) to change the current password.</p>	Type password [ENT]	<div style="border: 1px solid black; padding: 5px;"> <p>Password [ON]</p> <p>EXIT CHANGE                      ON OFF</p> </div>
<p>4 The password-input screen will appear. At the blinking cursor type in the new password and press the [ENT] key. <b>IMPORTANT: DON'T FORGET YOUR PASSWORD.</b></p>	[F2]	<div style="border: 1px solid black; padding: 5px;"> <p>Password Input a password [                      ]</p> <p>EXIT                                      BS</p> </div>
<p>5 The confirmation screen will appear. At the blinking cursor type in the new password and press the [ENT] key.</p>	Type password [ENT]	<div style="border: 1px solid black; padding: 5px;"> <p>Password Input again (confirmation) [                      ]</p> <p>EXIT                                      BS</p> </div>
<p>6 The confirmation screen will appear to confirm your new password. Type in the new password once again and press [ENT].</p>	Type password [ENT]	<div style="border: 1px solid black; padding: 5px;"> <p>Password [ON]</p> <p>EXIT CHANGE                      ON OFF</p> </div>
<p>6 The password option screen will appear once again. Press the [F1](EXIT) to return back to the main menu icons.</p>	[F1]	

## 9 CHECK AND ADJUSTMENT

### 9.1 Checking and Adjusting of Instrument Constant

Normally, the instrument constant does not have discrepancy. It is recommended you measure and compare with an accurately measured distance at a location where the precision is specifically monitored on a consistent basis. If such a location is not available, establish your own base line over 20m (when purchasing the instrument) and compare with the data measured with newly purchased instrument.

In both cases note that the setup displacement of the instrument position over the point, the prism, baseline precision, poor collimation, atmospheric correction, and correction for refraction and earth curvature determine the inspection precision. Please keep in mind these points.

Also, when providing a base line in a building, please note that the difference in temperature greatly changes the length measured in the building.

If a difference of 5mm or over is the result from the comparative measurement, the following procedure as shown below could be used to change the instrument constant.

- 1) Provide point C on a straight line, connecting straight line AB which is almost horizontal and about 100m long, and measure straight lines AB, AC and BC.

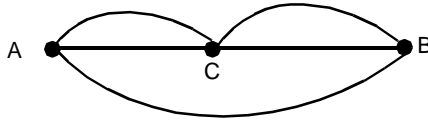

- 2) Obtain the instrument constant by repeating 1) above several times.  
Instrument constant=AC+BC-AB
- 3) When there is error between written instrument constant value and calculated value, review the Section 9.7 "How to Set the Instrument Constant Value" procedure.
- 4) Once again, measure at a calibrated baseline and compare with the instrument base line the length.
- 5) If using above procedure and no difference is found from the instrument constant at the factory or a difference of over 5mm is found, contact TOPCON or your TOPCON dealer.

## 9.2 Checking the Optical Axis

To check if the optical axis of EDM and theodolite are matched, follow the procedure below. It is especially important to check after adjustment of the eyepiece reticle is carried out.

- 1) Position a prism about 30 to 50m apart from GTS-820A series.
- 2) After the power switch ON of GTS-820A series, collimate the center of the prism.
- 3) Press the soft key (Set audio) in the star key mode.  
Buzzer sounds continuously.

### H direction confirmation (Do not move V direction).

- 4) Turn the horizontal jog counterclockwise slowly, move the collimating point to the left side of prism gradually until buzzer sound stops.

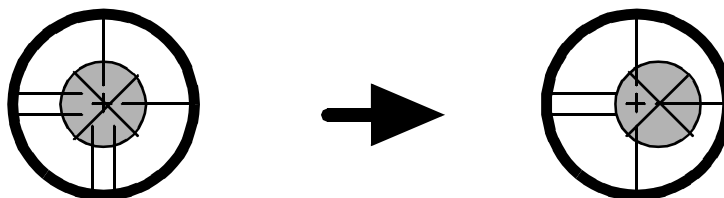

- 5) Turn the horizontal jog clockwise slowly, and move the collimating point to the prism center gradually until at the position buzzer starts.  
Confirm the level of the signal (light quantity level) in display to adjust at the level of one to two as shown in below by turning the horizontal jog.

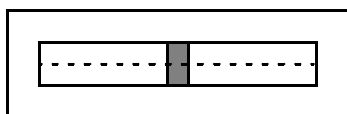

Quantity level one

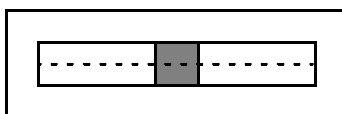

Quantity level two

- 6) Press the [ESC] key and measure the horizontal angle, and note the horizontal angle displayed. Or you can do 0-set of horizontal angle.
- 7) Return to the Set Audio in star key again.
- 8) Turn the horizontal jog clockwise, move the collimating point to the right side of prism gradually until buzzer sound stops.

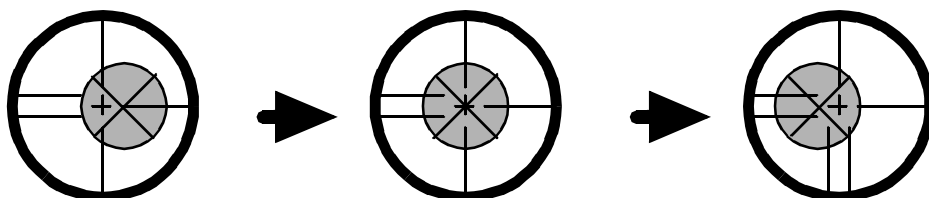

- 9) Move the collimating point to the center of prism gradually until buzzer sound starts.  
Turning the horizontal jog to be one to two level of SIG value to adjust the collimating point same as 5) procedure.
- 10) Note horizontal angle same as 6) procedure.
- 11) Calculate the average value of 6) and 10).

[Example]

6) ●●●●●●●● 0° 00' 00"

10) ●●●●●●●● 0° 08' 20"

---

Average value 0° 04' 10"

- 12) Climate to the center of prism. Compare the reading horizontal angle value and calculated value in 11). If the difference is within 1'30", no problem for use.

**Vertical direction confirmation (Do not move Horizontal direction).**

13) Carry out as Horizontal direction confirmation.

Compare the reading Vertical angle value and calculated value.

If the difference is within 1' 30", no problem for use. If the difference is more than mentioned value, contact with your Topcon dealer or Topcon.

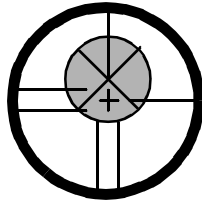

[Example]  $90^{\circ}12'30''$

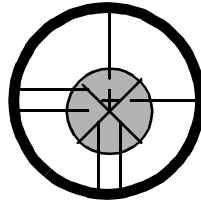

$90^{\circ}04'30''$

Average	$90^{\circ}08'30''$	}	Difference 20"
Reading to prism center	$90^{\circ}08'50''$		

### 9.3 Checking/Adjusting the Theodolite Functions

#### 1 Pointers on the Adjustment

- 1) Adjust the eyepiece of the telescope properly prior to any checking operation which involves sighting through the telescope.  
Remember to focus properly, with parallax completely eliminated.
- 2) Carry out the adjustments in the order of item numbers, as the adjustments are dependent one upon another. Adjustments carried out in the wrong sequence may even nullify previous adjustment.
- 3) Always conclude adjustments by tightening the adjustment screws securely (but do not tighten them more than necessary, as you may strip the threads, twist off the screw or place undue stress on the parts).  
Furthermore, always tighten by revolving in the direction of tightening tension.
- 4) The attachment screws must also be tightened sufficiently, upon completion of adjustments.
- 5) Always repeat repeat checking operations after adjustments are made, in order to confirm results.

#### 1 Notes on the Tribrach

Note that the angle measuring precision may be effected directly if the tribrach has not been installed firmly.

- 1) If there is any slack between the leveling screws and the base, loosen the set screw of the holding ring and tighten the holding ring with adjusting pin, until it is properly adjusted. Re-tighten the set screw on completing the adjustment.

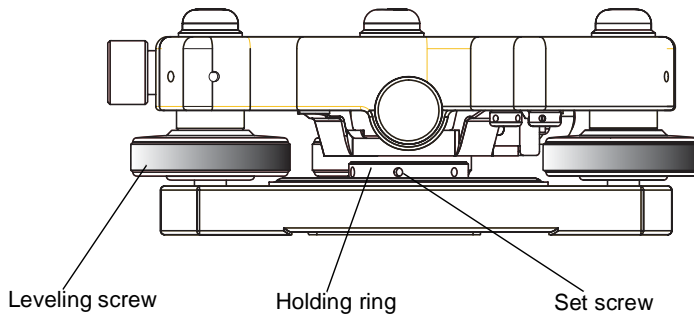

### 9.3.1 Checking /Adjusting the Plate Level

Adjustment is required if the axis of the plate level is not perpendicular to the vertical axis.

#### 1 Check

- 1) Place the plate level parallel to a line running through the centers of two leveling screws, say, A and B. Use these two leveling screws only and place the bubble in the center of the plate level.
- 2) Rotate the instrument  $180^\circ$  or  $200g$  around the vertical axis and check bubble movement of the plate level. If the bubble has been displaced, then proceed with the following adjustment.

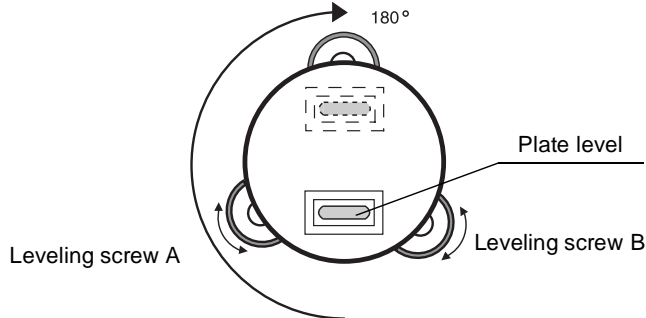

#### 1 Adjustment

- 1) Adjust the level adjustment capstan screw, with the accessory adjusting pin and return the bubble towards the center of the plate level. Correct only one-half of the displacement by this method.
- 2) Correct the remaining amount of the bubble displacement with the leveling screws.
- 3) Rotate the instrument  $180^\circ$  or  $200g$  around the vertical axis once more and check bubble movement. If the bubble is still displaced, then repeat the adjustment.

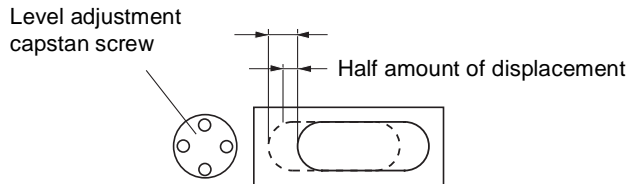

### 9.3.2 Checking /Adjusting the Circular Level

Adjustment is required if the axis of the circular level is also not perpendicular to the vertical axis.

#### 1 Check

- 1) Carefully level the instrument with the plate level only. If the bubble of the circular level is centered properly, adjustment is not required. Otherwise, proceed with the following adjustment.

#### 1 Adjustment

- 1) Shift the bubble to the center of the circular level, by adjusting three capstan adjustment screws on the bottom surface of the circular level, with the accessory adjusting pin.

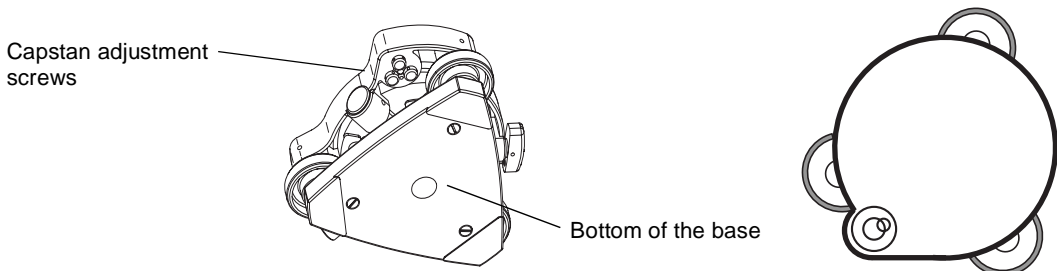



### 9.3.3 Adjustment of the Vertical Cross-hair

Adjustment is required if the vertical cross-hair is not in a plane perpendicular to the horizontal axis of the telescope (since it must be possible to use any point on the hair for measuring horizontal angles or vertically running lines).

#### 1 Check

- 1) Set the instrument on the tripod and carefully level it.
- 2) Sight the cross-hairs on a well defined Point A at a distance of, at least, 50 meters (160ft.).
- 3) Next swing the telescope vertically using the jog/shuttle, and check whether the point travels along the length of the vertical cross-hair.
- 4) If the point appears to move continuously on the hair, the vertical cross-hair lies in a plane perpendicular to the horizontal axis (and adjustment is not required).
- 5) However, if the point appears to be displaced from the vertical cross-hair, as the telescope is swung vertically, adjustment is required in the reticle plate.

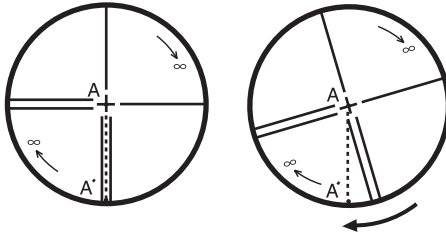

#### 1 Adjustment

- 1) Unscrew the cross-hair adjustment section cover, by revolving it in the counterclockwise direction, and take it off. This will expose four eyepiece section attachment screws.

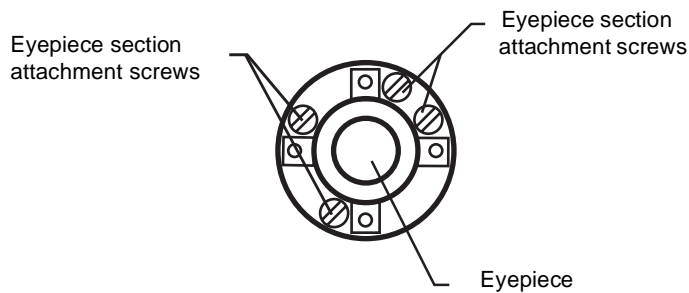

- 2) Loosen all four attachment screws slightly with the accessory screw-drive (while taking note of the number of revolutions). Then revolve the eyepiece section so that the vertical cross-hair coincides to Point A'. Finally, re-tighten the four screws by the amount that they were loosened.
- 3) Check once more and if the point travels the entire length of the vertical cross-hair, further adjustment is not required.

**Note:** Perform following adjustment after completing the above adjustment.  
 Section 9.3.4 "Collimation of the Instrument", Section 9.4 "Adjustment of Compensation Systematic Error of Instrument" and Section 9.9 "Inspection and Adjustment of Optic Axis for Auto -Tracking" .

**9.3.4 Collimation of the Instrument**

Collimation is required to make the line of sight of the telescope perpendicular to the horizontal axis of the instrument, otherwise, it will not be possible to extend a straight line by direct means.

**1 Check**

- 1) Set the instrument up with clear sights of about 50 to 60 meters (160 to 200 ft.) on both sides of the instrument.
- 2) Level the instrument properly with the plate level.
- 3) Sight Point A at approximately 50 meters (160 ft.) distance.
- 4) Rotate the telescope 180° or 200g around the horizontal axis, so that the telescope is pointed in the opposite direction.
- 5) Sight Point B, at equal distance as Point A.
- 6) Rotate the instrument 180° or 200g around the vertical axis. Fix a sight on Point A once more.
- 7) Rotate the telescope 180° or 200g around the horizontal axis once more and fix a sight on Point C, which should coincide with previous Point B.
- 8) If Points B and C do not coincide, adjust in the following manner.

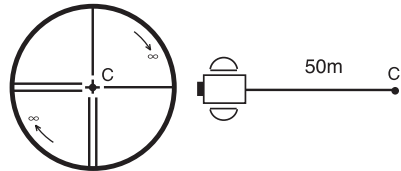
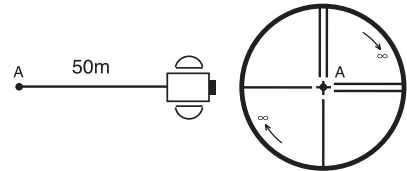
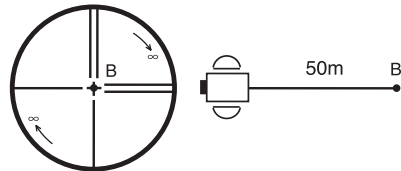
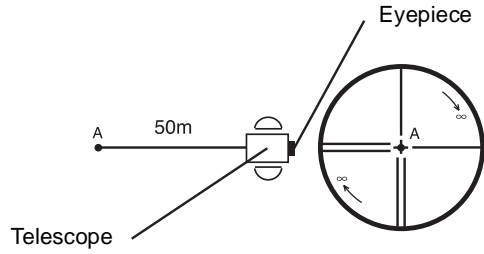

**1 Adjustment**

- 1) Unscrew the cross-hair adjustment section cover.
- 2) Find Point D at a point between Points C and B, which should be equal to 1/4th the distance between Points B and C and measured from Point C. This is because the apparent error between Points B and C is four times the actual error since the telescope has been reversed twice during the checking operation.

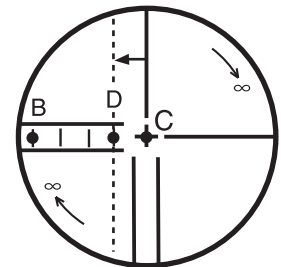

- 3) Shift the vertical cross-hair line and coincide it with Point D, by revolving the left and right capstan adjustment screws with the adjusting pin. Upon completing the adjustment, repeat the checking operation once more. If Points B and C coincide, further adjustment is not required. Otherwise, repeat the adjustment.

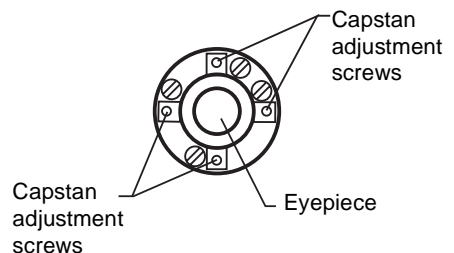

Note: 1 First, loosen the capstan adjustment screw on the side to which the vertical cross-hair line must be moved. Then tighten the adjustment screw on the opposite side by an equal amount which will leave the tension of the adjustment screws unchanged. Revolve in the counterclockwise direction to loosen and in the clockwise direction to tighten, but revolve as little as possible.

2 Perform following adjustment after complete above adjustment. Section 9.4 "Adjustment of Compensation Systematic Error of Instrument", Section 9.2 "Checking the Optical Axis" and Section 9.9 "Inspection and Adjustment of Optic Axis for Auto -Tracking" .

### 9.3.5 Checking / Adjusting the Optical Plummet Telescope

Adjustment is required to make the line of sight of the optical plummet telescope coincide with the vertical axis (otherwise the vertical axis will not be in the true vertical above the reference point when the instrument is optically plumbed).

1 **Check**

- 1) Coincide the center mark and the point. (See Chapter 2 "PREPARATION FOR MEASUREMENT".)
- 2) Rotate the instrument 180° or 200g around the vertical axis and check the center mark. If the point is properly centered in the center mark, adjustment is not required. Otherwise, adjust in the following manner.

1 **Adjustment**

- 1) Take off the adjustment section cover of the optical plummet telescope eyepiece. This will expose four capstan adjustment screws which should be adjusted with the accessory adjusting pin to shift the center mark to the point. However, correct only one-half of the displacement in this manner.

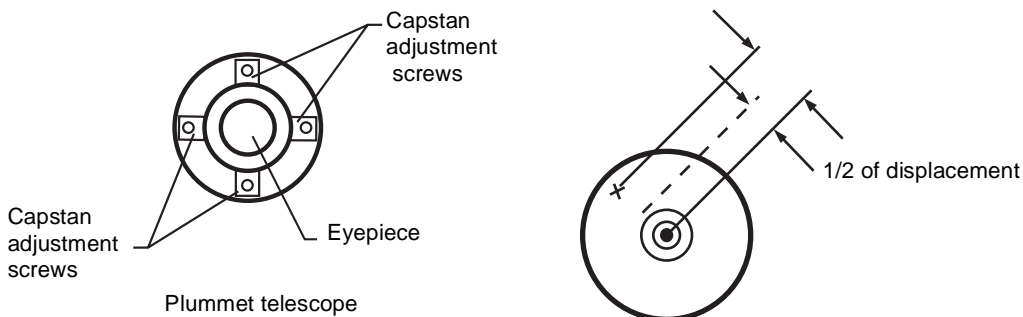

- 2) Use the leveling screws and coincide the point and center mark.
- 3) Rotate the instrument 180° or 200g around the vertical axis once more and check the center mark. If it is coincided to the point, then further adjustment is not required. Otherwise, repeat the adjustment.

Note: First, loosen the capstan adjustment screw on the side to which the center mark must be moved. Then tighten the adjustment screw on the opposite side by an equal amount which will leave the tension of the adjustment screws unchanged. Revolve in the counterclockwise direction to loosen and in the clockwise direction to tighten, but revolve as little as possible.



### 9.4 Adjustment of Compensation Systematic Error of Instrument

- 1) Error of vertical axis (X,Y tilt sensor offset)
- 2) Collimation error
- 3) Error of vertical angle 0 datum
- 4) Error of horizontal axis

The above mentioned errors will be compensated by software, which calculated internally according to each compensation value.

Also these errors can be compensated by software collimating one side of the telescope that is carried out to delete the error by turning in normal and reverse both sides of telescope so far.

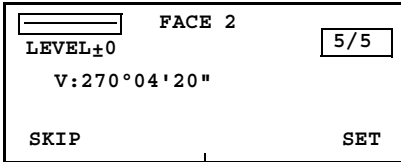
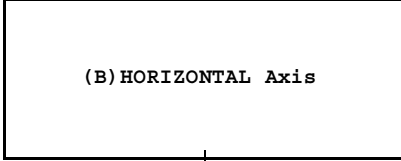
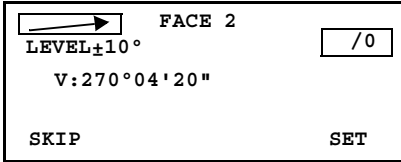
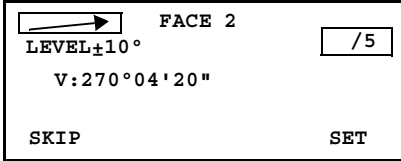
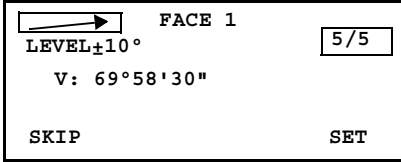
Operating procedure	Operation	Display
<p><b>1</b> Level the instrument properly with the plate level.</p>		
<p><b>2</b> Press [F5] key from the main menu.</p>	[F5]	<div style="border: 1px solid black; padding: 5px;"> <p>Adjustment</p> <hr/> <p>F1 V0/Axis (Measurement)</p> <p>F2 V0/Axis (Constant list)</p> <p>F3 Date Time</p> <p>F4 Instrument constant ↓</p> </div>
<p><b>3</b> Press [F1] key .</p>	[F1]	<div style="border: 1px solid black; padding: 5px; text-align: center;"> <p>[V0/Axis Adjustments]</p> </div>
		<div style="border: 1px solid black; padding: 5px; text-align: center;"> <p>↓</p> <p>ERROR CORRECTION</p> <p>(A) Tilt,V0 init,Collimation</p> <p>(B) H Axis</p> </div>
		<div style="border: 1px solid black; padding: 5px; text-align: center;"> <p>↓</p> <p>(A) COLLIMATION</p> </div>
<p><b>4</b> Collimate target A (around 0° in horizontal within ±3°) in normal telescope setting (FACE(1)).</p>	Collimate A (Normal)	<div style="border: 1px solid black; padding: 5px;"> <p>LEVEL±0      FACE 1      /0</p> <p style="text-align: center;">V: 88°40'20"</p> <p>SKIP                                  SET</p> </div>
<p><b>5</b> Press [F6](SET)key. *1) The sample display shows that the measurement is made 5 times in FACE 1.</p>	[F6]	<div style="border: 1px solid black; padding: 5px;"> <p>LEVEL±0      FACE 1      /5</p> <p style="text-align: center;">V: 89°55'50"</p> <p>SKIP                                  SET</p> </div>
<p><b>6</b> Turn the telescope in reverse telescope setting (FACE(2)).</p>	Turn telescope	<div style="border: 1px solid black; padding: 5px;"> <p>LEVEL±0      FACE 2      0/5</p> <p style="text-align: center;">V: 270°04'20"</p> <p>SKIP                                  SET</p> </div>

<p><b>7</b> Collimate target A.</p> <p><b>8</b> Press [F6](SET)key. Repeat the procedures in step <b>7</b> and <b>8</b> so that the count of measured times matches to the one in FACE(1). * 2),3),4)</p> <p>The title display will be shown automatically.</p>	<p>Collimate A (Reverse)</p> <p>[F6]</p>	 <p style="text-align: center;">↓</p>  <p style="text-align: center;">↓</p> 
<p><b>9</b> Collimate target B (more than ±10° from the level ) in reverse telescope setting (FACE(2)). *5)</p> <p><b>10</b> Press [F6](SET)key. *1)</p>	<p>Collimate B (Reverse)</p> <p>[F6]</p>	
<p><b>11</b> Turn the telescope in normal telescope setting(FACE(1)).</p>	<p>Turn telescope</p>	
<p><b>12</b> Collimate target B.</p> <p><b>13</b> Press [F6](SET) key. Repeat the procedures in step <b>12</b> and <b>13</b> so that the count of measured times matches to the one in FACE(2). Then the display returns to main menu.</p>	<p>Collimate B (Normal)</p> <p>[F6]</p>	

\*1) It is able to get the average value from 1 to 10 measurements. To get the average, repeat the procedures in steps **4**, **5** or **9**, **10**. The measured times is counted in the second line of display.  
 \*2) The compensation values of 1) Error of vertical axis (X,Y tilt sensor offset),  
 2) Collimation error, and 3) Error of vertical angle 0 datum will be set and memorized internally.  
 \*3) The operating procedure steps to set compensation value of 4) Error of horizontal axis.  
 \*4) Pressing [F1](SKIP) key enables to set next step without changing the last compensated value.  
 \*5) Pressing [F1](SKIP) key makes end of setting without changing compensation value.

## 9.5 Showing Constant List and Switch ON/OFF Compensation Systematic Error of Instrument

[Example setting: Switch OFF the compensation]

Operating procedure	Operation	Display
<b>1</b> Press [F5] key from the main menu.	[F5]	<pre> Adjustment ----- F1 V0/Axis (Measurement) F2 V0/Axis (Constant list) F3 Date Time F4 Instrument constant  ↓           </pre>
<b>2</b> Press [F2] key . Correction values are displayed.	[F2]	<pre> Vco:  -1°57'12" Hco:  -0°00'20" Hax:  -0°00'20"  EXIT                                ON  OFF           </pre>
<b>3</b> Press [F6](OFF) key.	[F6]	<pre> Vco:  -1°57'12" Hco:  _____ Hax:  _____  EXIT                                ON  OFF           </pre>
<b>4</b> Press [F1](EXIT) key. The display returns to main menu.	[F1]	

## 9.6 How to adjust the date and time

Operating procedure	Operation	Display
<b>1</b> Press [F5] key from the main menu.	[F5]	<pre>Adjustment ----- F1 V0/Axis (Measurement) F2 V0/Axis (Constant list) F3 Date Time F4 Instrument constant  ↓</pre>
<b>2</b> Press [F3] key. Current date will be on the display.	[F3]	<pre>Current date is 01-25-02 Enter new date (mm-dd-yy) Modify                                 YES  NO</pre>
<b>3</b> Press [F5] (YES) key. The cursor will blink on the first digit to type in a numeric value.	[F5]	<pre>Current date is 01-25-02 Enter new date (mm-dd-yy)  EXIT                                BS</pre>
<b>4</b> Input new date and press [ENT] key. [Example:07-29-02]	[0][7] [2][9] [0][2] [ENT]	<pre>Current time is 14:55:28 Enter new time (hh-mm-ss) Modify                                 YES  NO</pre>
<b>5</b> Press [F5] (YES) key.	[F5]	<pre>Current time is 14:55:28 Enter new time (hh-mm-ss)  EXIT                                BS</pre>
<b>6</b> Input new time and press [ENT] key. [Example:13:20:50] The display returns to main menu.	[1][3] [2][0] [5][0] [ENT]	
<p>1 The [F6](BS) key is for moving the cursor to the left one digit at a time for editing.(If you do not want to change the date, press the [F1](EXIT) key or [ESC] key to get to the time display.</p> <p>1 Enables you to change the order of date, see Chapter 8 "PARAMETERS SETTING MODE" .</p>		

## 9.7 How to Set the Instrument Constant Value

To set the Instrument constant which is obtained in section 9.1 “Checking and Adjusting of Instrument Constant”, follow as below.

Operating procedure	Operation	Display
<b>1</b> Press the [F5] key from the main menu.	[F5]	<pre> Adjustment ----- F1 V0/Axis (Measurement) F2 V0/Axis (Constant list) F3 Date Time F4 Instrument constant  ↓           </pre>
<b>2</b> Press [F4] (Instrument constant) key.	[F4]	<pre> Instrument Constant       EDM OFFSET (mm)               0.0 Modify                                 YES  NO           </pre>
<b>3</b> Press [F5] (YES) key .	[F5]	<pre> Instrument Constant       EDM OFFSET (mm)               0.0  EXIT                                BS           </pre>
<b>4</b> Input value and press [ENT] key.	Input value [ENT]	<pre> Instrument Constant       EDM OFFSET (mm)               1.2                                 OK  CANCEL           </pre>
<b>5</b> Press [F5](OK) key.  The display returns to main menu.	[F5]	<pre> Complete           </pre>



## 9.8 Reference Frequency Checking Mode

The beam modulated by the reference frequency of EDM is emitted continuously.

This mode is used for frequency test mainly.

Operating procedure	Operation	Display
<b>1</b> Press the [F5] key from the main menu icons.	[F5]	<pre> Adjustment ----- F1 V0/Axis (Measurement) F2 V0/Axis (Constant list) F3 Date Time F4 Instrument constant  ↓           </pre>
<b>2</b> Press the [F6](↓) key to get to next page on the display.	[F6]	<pre> Adjustment ----- F1 FRQ check F2 Adj Tracking Axis                                      ↑           </pre>
<b>3</b> Press the [F1] key. The beam will be emitted.	[F1]	<pre> FRQ Check During the signal output••  EXIT           </pre>
<b>4</b> To return to the main menu icons, press the [F1] (EXIT) key.	[F1]	

### 9.9 Inspection and Adjustment of Optic Axis for Auto -Tracking

Activates auto tracking to the prism.

Confirm if the center of telescope reticle and the center of the prism is coincided.

Any error between them requires adjustment according to the following procedure.

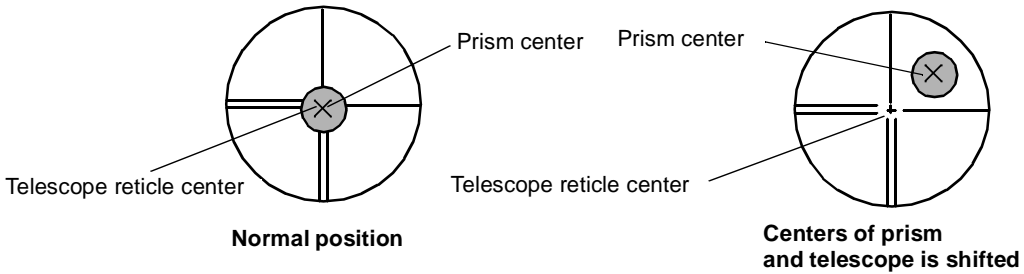

- 1 Position a prism around 0 in horizontal and more than 100m (328ft) apart from the GTS-820A series.
- 1 Take care not to be interrupted the optical path during measurement.

Operating procedure	Operation	Display
1 Level the instrument properly with the plate level and press the [F5] key from main menu.	[F5]	<pre> Adjustment ----- F1 V0/Axis (Measurement) F2 V0/Axis (Constant list) F3 Date Time F4 Instrument constant  ↓                     </pre>
2 Press the [F6] key to get the next page.	[F6]	<pre> Adjustment ----- F1 FRQ check F2 Adj Tracking Axis                     ↑                     </pre>
3 Press the [F2] key to select the adjustment of tracking axis.	[F2]	<pre> Adj Tracking Axis                     [1/2] &gt;Sight the prism !! TURN                    MEAS                     </pre>
4 Operate H / V jog shuttle to collimate the center of prism	Collimate	
5 Press the [F6](MEAS) key. The measurement starts.	[F6]	<pre> Adj Tracking Axis                     Wait                     </pre>
6 After the measurement, press the [F1](TURN) key. The instrument and telescope will turn automatically.	[F1]	<pre> Adj Tracking Axis                     [2/2] &gt;Sight the prism !! TURN                    MEAS                     </pre>
7 Operate H / V jog shuttle to collimate the center of prism	Collimate	





# 10 SETTING THE PRISM CONSTANT VALUE

The prism constant value of Topcon is set to zero. When using prism other than Topcon's, it is necessary to set the prism constant correction value of that specific prism.

Once you set the correction value for prism constant, it is retained after power is OFF.

1 Setting the prism constant value is in the STAR key mode.

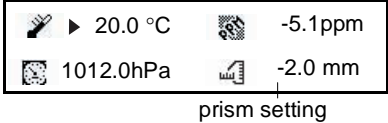
1 Setting example : The prism constant value : -14mm

Operating procedure	Operation	Display
<p><b>1</b> Press STAR (H) key. Press the [F6] key twice to get the page three.</p>	<p>[H] [F6] twice</p>	
<p><b>2</b> Press the [F2] key. Current setting value is displayed.</p>	<p>[F2]</p>	
<p><b>3</b> Move the cursor (&gt;) to psm setting by pressing [F5]((→, ←) key or [F6](↓,↑) key.</p>	<p>Move cursor</p>	
<p><b>4</b> Input the Prism constant correction value and press the [ENT] key. *1)</p> <p>The display returns STAR key menu.</p>	<p>Enter value [ENT]</p>	
<p>*1) Input range : -99.9mm to +99.9mm, 0.1mm step</p>		

# 11 SETTING ATMOSPHERIC CORRECTION

The velocity of light through air is not constant and depends on the atmospheric temperature and pressure. The atmospheric correction system of this instrument corrects automatically when the correction value is set. 15°C/59°F, and 1013.25hPa / 760mmHg / 29.9 inHg is as a standard value for 0ppm in this instrument. The values are kept in the memory even after power is OFF.

1 Setting the atmospheric correction value is in the STAR key ( H ) mode.

## 11.1 Calculation of Atmospheric Correction

The followings are the correction formulas.

Unit; meter

$$Ka = \left\{ 279.67 - \frac{79.535 \times P}{273.15 + t} \right\} \times 10^{-6}$$

*Ka*: Atmospheric correction value  
*P* : Ambient atmospheric pressure (hPa)  
*t* : Ambient Atmospheric temperature (°C)

The distance L (m) after atmospheric correction is obtained as follow.

$$L = l / (1 + Ka)$$

*l* : Measured distance when atmospheric correction is not set.

Example : In case Temperature +20°C, Air pressure 847hPa, l =1000 m

$$Ka = \left\{ 279.67 - \frac{79.535 \times 847}{273.15 + 20} \right\} \times 10^{-6}$$

$$\approx + 50 \times 10^{-6} \text{ (50 ppm)}$$

$$L = 1000 (1 + 50 \times 10^{-6}) = 1000.050 \text{ m}$$

## 11.2 Setting of Atmospheric Correction Value

### 1 How to Set Temperature and Pressure Value Directly

Measure the temperature and air pressure surrounding the instrument beforehand.

Example : Temperature: +26°C, Pressure:1020 hPa



Operating procedure	Operation	Display
<b>1</b> Press STAR (H) key. Press the [F6] key twice to get the page three.	[H] [F6] twice	
<b>2</b> Press the [F2] key. Current setting value is displayed.	[F2]	<p>Temperature setting</p>
<b>3</b> Input Temp.value and press [ENT] key. [Example] Temp. : +26°C The cursor moves to Pressure setting automatically	Enter value [ENT]	<p>Pressure setting</p>
<b>4</b> Input Pressure value, and press [ENT]. [Example] Pres. :1020.0hPa. The display returns previous mode. *1) *2)	Enter value [ENT]	

The display returns STAR key menu.		
<p>*1) Range : Temp. -30.0 °C to +60.0 °C (0.1 °C step)                  Pres. 560.0 to 1066.0hPa (0.1hPa step) , 420.0 to 800.0mmHg (0.1mmHg step)                  16.5 to 31.5inHg (0.1inHg step)</p> <p>*2) When the atmospheric correction value, which is calculated from the input temperature and pressure values, exceeds the range <math>\pm 999.9</math>ppm, the operating procedure returns to step <b>3</b> automatically. Input values again.</p>		

**I How to Set the Atmospheric Correction Value Directly**

Measure the temperature and air pressure to find atmospheric correction value (ppm) from the chart or correction formula.

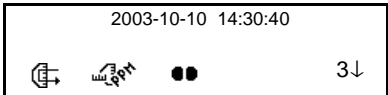
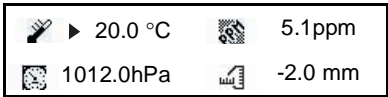
[Example] Atmospheric correction value

Operating procedure	Operation	Display
<p><b>1</b> Press STAR (H) key.                      Press the [F6] key twice to get the page three.</p>	<p>[H]                      [F6] twice</p>	
<p><b>2</b> Press the [F2] key.                      Current setting value is displayed.</p>	<p>[F2]</p>	
<p><b>3</b> Move the cursor (&gt;) to ppm setting by pressing [F5](→) key.</p>	<p>Move cursor</p>	
<p><b>4</b> Enter atmospheric correction value and press [ENT] key. *1)                       The display returns previous mode.</p>	<p>Enter ppm                      [ENT]</p>	
<p>*1) Input range : -999.9mm ~ +999.9mm, 0.1mm step</p>		

**Atmospheric Correction Chart (For your reference)**

The atmospheric correction value is obtained easily with the atmospheric correction chart. Find the measured temperature in horizontal, and pressure in vertical on the chart. Read the value from the diagonal line, which represents the required atmospheric correction value.

Example:

The measured temperature is +26°C

The measured pressure is 1013 hPa

Therefore,

The correction value is +10ppm

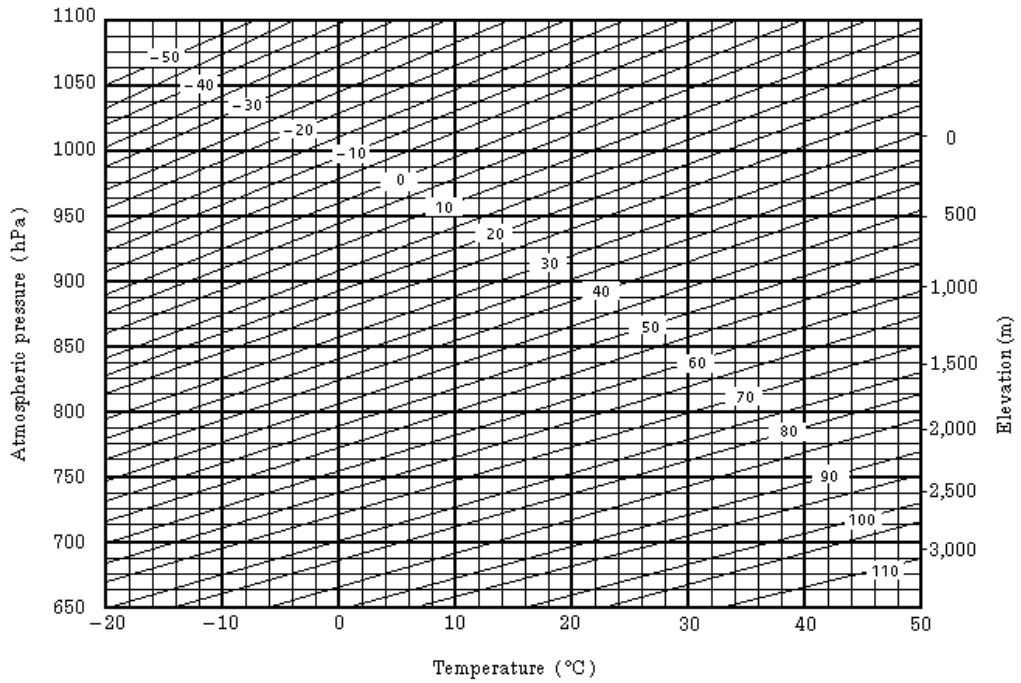

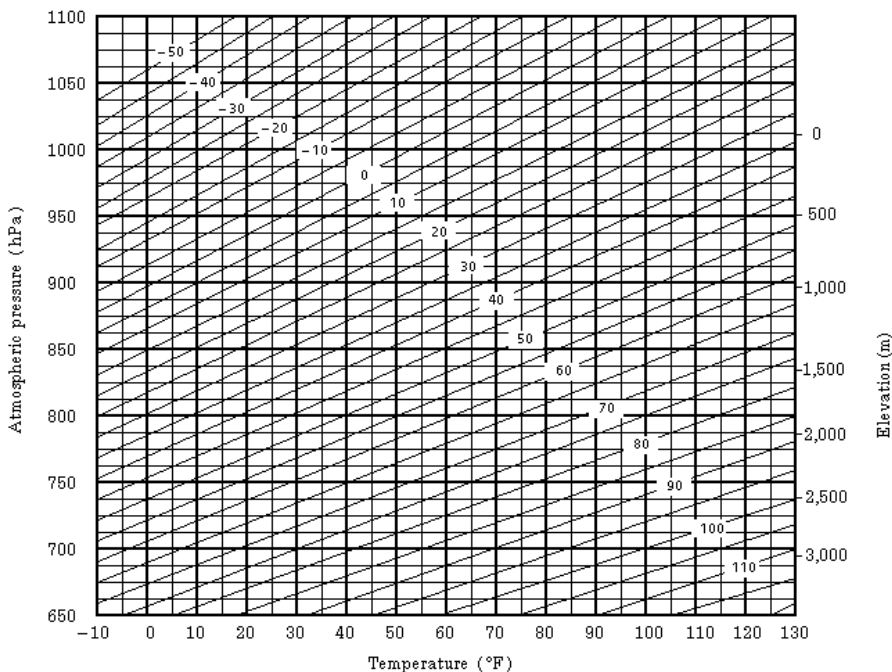
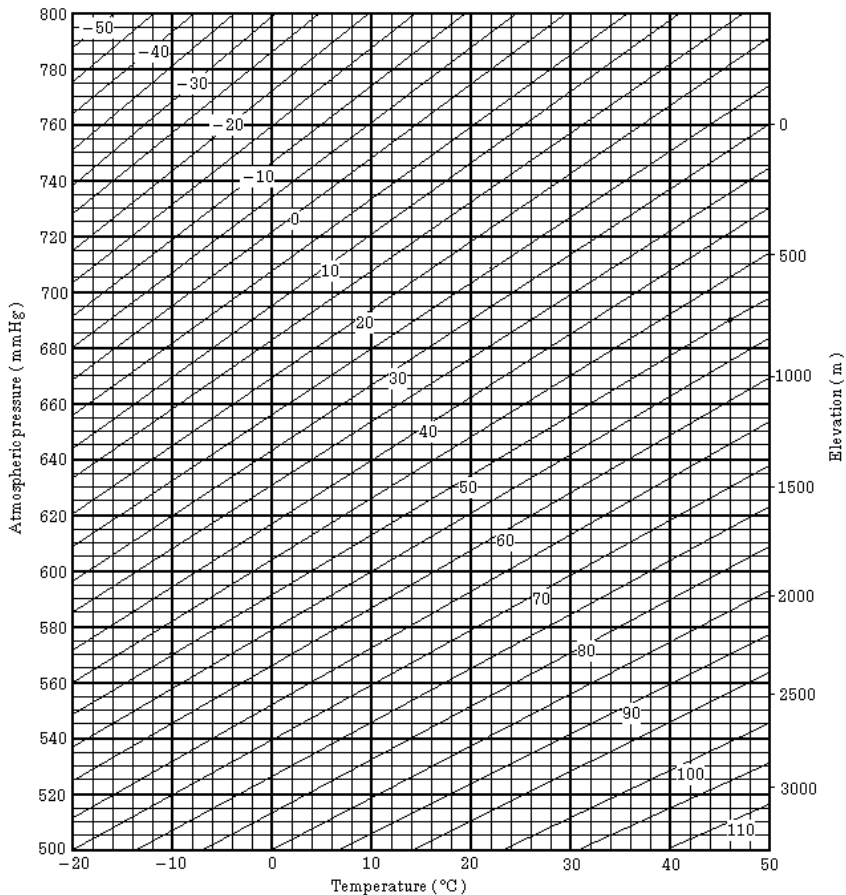



11 SETTING ATMOSPHERIC CORRECTION

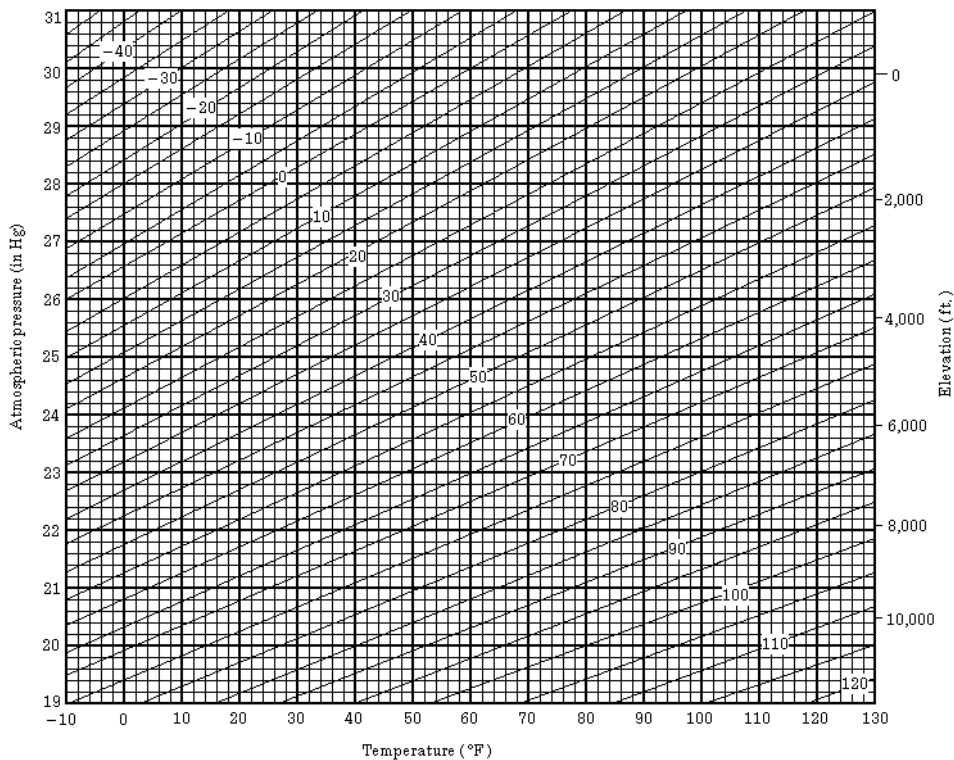

# 12 CORRECTION FOR REFRACTION AND EARTH CURVATURE

The instrument measures distance, taking into account correction for refraction and earth curvature.

Note: If the telescope is positioned within  $\pm 9^\circ$  from the nadir or zenith, no measurement will result even if the correction function for refraction and earth curvature works.  
The display shows "W/C OVER".

## 12.1 Distance Calculation Formula

Distance Calculation Formula; with correction for refraction and earth curvature taken into account. Follow the Formula below for converting horizontal and vertical distances.

Horizontal distance  $D = AC(\alpha)$  or  $BE(\beta)$   
 Vertical distance  $Z = BC(\alpha)$  or  $EA(\beta)$   
 $D = L\{\cos\alpha - (2\theta - \gamma) \sin\alpha\}$   
 $Z = L\{\sin\alpha + (\theta - \gamma) \cos\alpha\}$

$\theta = L \cdot \cos\alpha / 2R$ ..... Earth curvature correcting item

$\gamma = K \cdot L \cdot \cos\alpha / 2R$ ..... Atmospheric refraction correcting item

$K = 0.14$  or  $0.2$ ..... Coefficient of refraction

$R = 6372\text{km}$ ..... Radius of earth  
 $\alpha$  ( or  $\beta$ )..... Altitude angle  
 $L$  ..... Slope distance

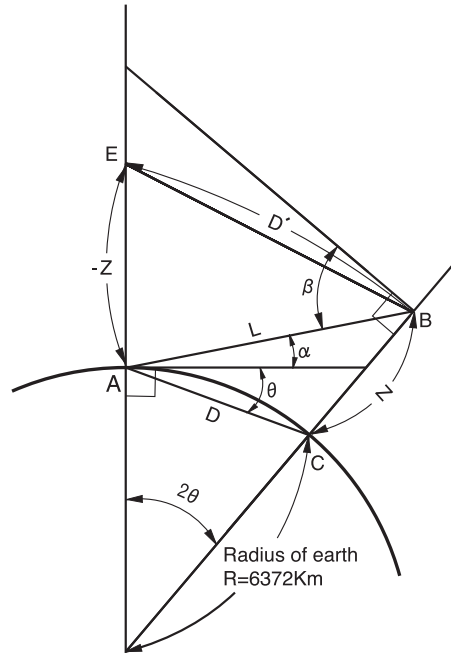

1 The conversion formula for horizontal and vertical distances is as follows when correction for refraction and earth curvature is not applied.

$D = L \cdot \cos\alpha$   
 $Z = L \cdot \sin\alpha$

Note: The coefficient of the instrument has been set at 0.14 before shipment ( $K=0.14$ ). if the "K" value is to be changed, refer to 8 "PARAMETERS SETTING MODE".

# 13 POWER SOURCE AND CHARGING

## 13.1 Rechargeable Battery BT-56Q

### 1 To remove

Remove the battery while pulling both battery fixing levers.

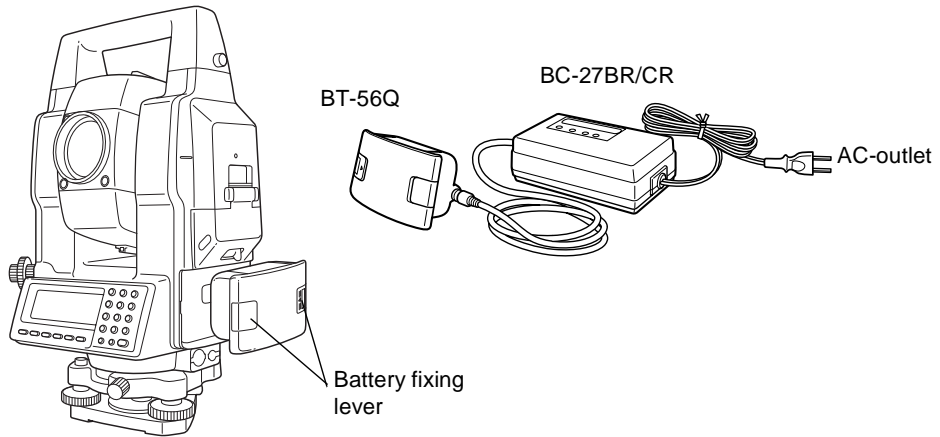

### 1 To charge

- 1 Plug the charger into the outlet.
- 2 Connect the charger connector to the battery, then charging will start. Preparatory charging will start.\* (The red lamp of the charger will blink.) When the preparatory charging is completed, the charging status will be switched to quick charging automatically. (The red lamp of the charger will light.)
- 3 Charging will take approximately 2.5 hours. (The green lamp will illuminate.)
- 4 After charging, remove the battery from the charger. Remove the charger from the outlet.

### 1 To refresh

Press the refresh switch after starting charging above steps (1, 2), then discharging will start. Confirm the yellow lamp illuminates.

After discharging is finished, charging will start automatically.

Time discharging battery charged fully is approximately 12 hours.

### 1 For refreshing

Rechargeable battery can be used repeatedly by charging. If charging is repeated by the state that capacity of the battery still left, operating time of the battery may shorten. In this case, the voltage of the battery will be recovered by refreshing and operating time can be improved.

### \*About Preparatory charging

Before quick charging, the battery is charged using small amount current to measure its temperature and voltage.

When the temperature and voltage is within a range, the charging status will change to quick charging.

### The lamp of charger

- Red blinking** : Preparatory charging
- Red ON** : Charging  
Red lamp will illuminate during charging.
- Green ON** : Charging completed  
Green lamp will illuminate after completely charging.
- Yellow ON** : Discharging  
Yellow lamp will illuminate and discharging will start by pressing the refresh (discharge) switch.
- Red quick flashing** : Abnormal outbreaks  
Red lamp will flash when the battery life is over or the battery is broken down.  
Replace the battery to new one.

### 1 To install

- 1 Place the battery to the instrument.
- 2 Gently push the battery and clicks into position.

- 1 Do not charge or discharge continuously, otherwise the battery and the charger may be deteriorated. If charging or discharging is necessary, use the charger after stopping charge for approximately 30 minutes.
- 1 Do not charge the battery or discharge the battery in right after the battery is charged, it causes deterioration of the battery in rare cases.
- 1 The charger may develop heat while charging, there is no problem of it.

- Note:
- 1 Recharging should take place in a room with an ambient temperature range of 10°C to 40°C (50°F to 104°F).
  - 2 If charging is done at high temperature, charging time of the battery may take longer.
  - 3 Exceeding the specified charging time may shorten the life of the battery and should be avoided if possible.
  - 4 The battery source will discharge when stored and should be checked before using with instrument .
  - 5 Be sure to charge as stored battery source every 3 or 4 months and store in a place at 30°C and below when it will not used for a long period.  
If you allow the battery to be completely discharged, it will have an effect on the overall performance for proper charging in the future.  
Keep batteries charged at all times.
  - 6 For further information, see APPENDIX 2 "Precaution when Charging or Storing Batteries".

# 14 DETACH/ATTACH OF TRIBRACH

The instrument is easily detached or attached to the tribrach.

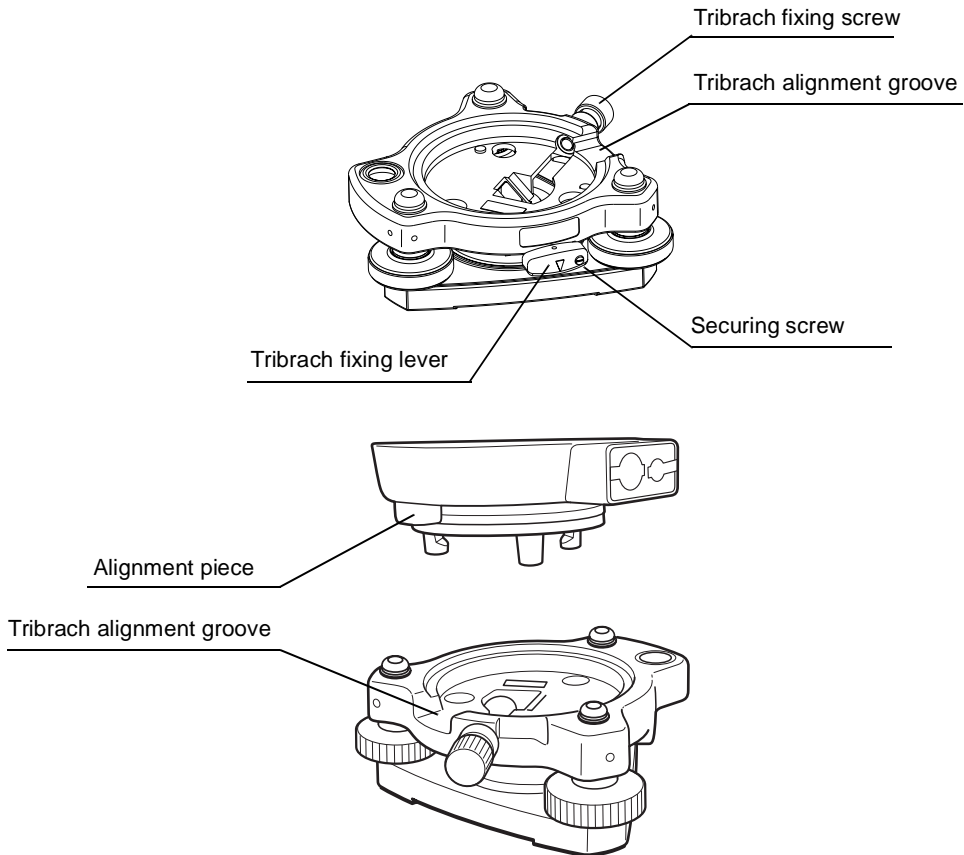

## 1 Detachment

- 1) Loosen the tribrach fixing screw.
- 2) Loosen the tribrach fixing lever by turning counterclockwise.
- 3) Lift the instrument straight upwards and off.

## 1 Attachment

- 1) Coincide the white alignment piece on the lower part of the instrument with the tribrach alignment groove.
- 2) Tighten the tribrach fixing lever firmly by turning clockwise.
- 3) Tighten the tribrach fixing screw.

## 1 Locking the Tribrach Fixing lever

The tribrach fixing lever can be locked from being moved accidentally. This is useful if the upper instrument section is not being detached very often. Simply tighten the securing screw on the fixing lever with the accessory screw driver.

# 15 BATTERY SYSTEM

In case of Rechargeable Battery BT-56Q

In case of External battery Pack



BT-56Q

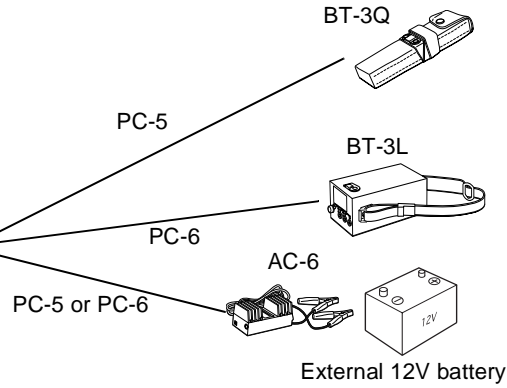
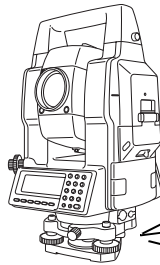

Charging

Charging time



BT-56Q

Approx. 2.5h

BC-27BR/CR



Quick  
BC-27BR for AC 120V use  
BC-27CR for AC 230V use

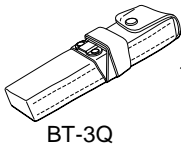

BT-3Q

Approx. 15h



BC-10C

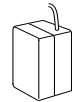

BC-10B

Normal  
BC-10B for AC 120V use  
BC-10C for AC 230V use

Approx. 1h

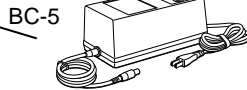

BC-5

Quick  
for AC 100V / 120V / 220V  
/ 240V use

Approx. 2h

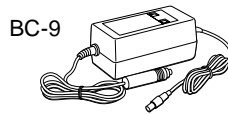

BC-9

Quick  
for DC 13.8 to 16V use

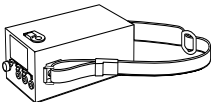

BT-3L

Approx. 15h

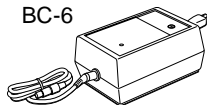

BC-6

Normal  
for AC 100V / 120V / 220V  
/ 240V use

# 16 PRISM SYSTEM

Arrangement according to your needs is possible.

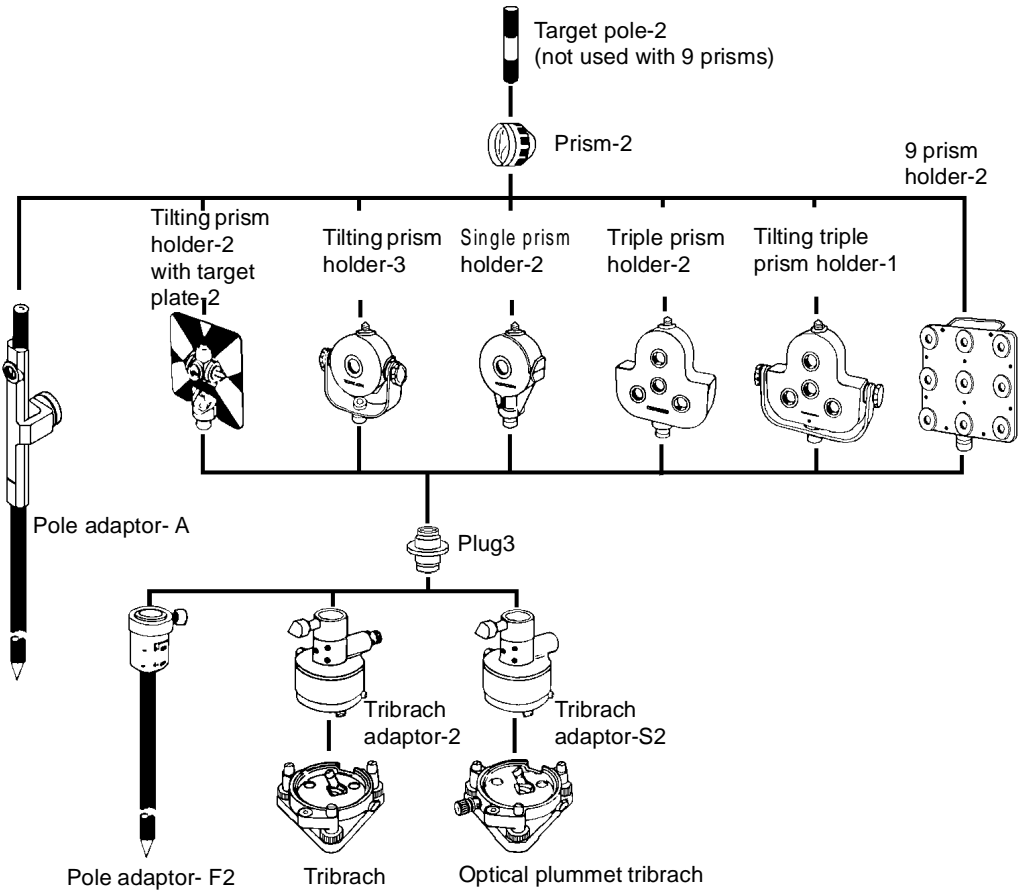

It is possible to change the combination according purpose.

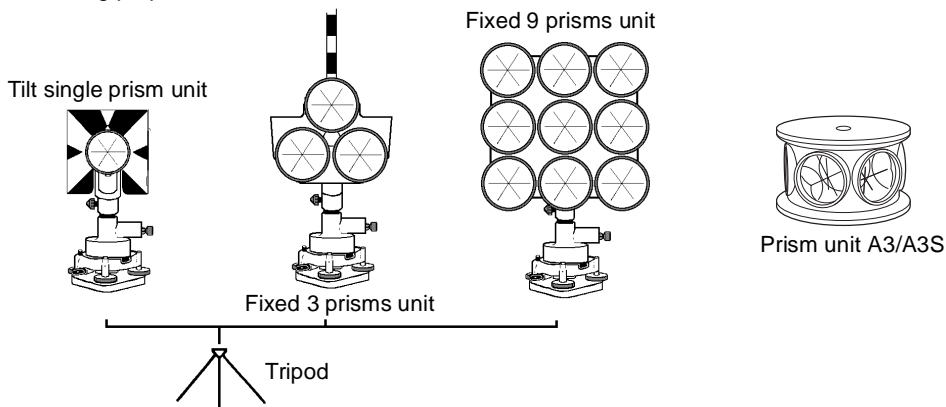

- 1 Use the above prisms after setting them at the same height as the instruments. To adjust the height of prism set, change the position of fixing screws.  
Plug 3 is necessary for the tribrach adaptor-2, tribrach adaptor-S2 and pole adaptor-F2 to coincide with the height of GTS-820A series.
- 1 TR-5 or TR-5P tribrach should be used for prism side when the traverse surveys is performed.

# 17 PRECAUTIONS

- 1) For transportation, hold by the handle or yoke of the instrument. Never hold by the lens barrel as it can affect the fixing bracket inside and reduce the accuracy of the instrument.
- 2) Never expose the instrument without a filter to direct sunlight. It may damage the components inside the instrument.
- 3) Never leave the instrument unprotected in high temperature. The temperature inside instrument may easily reach up to 70°C or above and will reduce the service life.
- 4) When a high degree of precision is required for measurement, provide shade against direct sunlight for the instrument and tripod.
- 5) Any sudden change of temperature to the instrument or prism may result in a reduction of measuring distance range, i.e. when taking the instrument out from a heated vehicle.
- 6) When opening the carrying case and taking out the instrument, place the case horizontally, then open the case.
- 7) When returning the instrument to its case, be sure to match the white positioning marks provided with the case and place the instrument with the eyepiece upward.
- 8) For transportation, provide dampening or a cushion appropriately to avoid sudden shock or vibration.
- 9) For cleaning the instrument after use, remove dust using a cleaning brush, then wipe off with a cloth.
- 10) For cleaning the lens surface, use a cleaning brush to remove the dust, then use a clean lintless cotton cloth. Moisten it with alcohol (or mixture with ether) to wipe gently in a rotational motion from the center out.
- 11) Even if any abnormality occurs, never attempt to disassemble or lubricate the instrument yourself. Always consult with TOPCON or your dealer.
- 12) To remove the dust on the case, never use thinner or benzine. Use a clean cloth moistened with neutral detergent.
- 13) Check each part of the tripod after extended use. Parts (screws or clamps) may work themselves free.



# 18 ERROR DISPLAYS

Error code	Description	Countermeasures
Backup battery empty	Displayed when built in battery for memory back up is empty.	Contact your dealer or Topcon.
W/C OVER	Displayed when measurement carried out within $\pm 9^\circ$ from zenith or nadir at the Earth curvature and refraction correction mode is ON.	Set correction for refraction and earth curvature mode OFF or measure out of $\pm 9^\circ$ from the zenith or Nadir.
H angle measuring error	Displayed when the instrument rotated too fast or any abnormality occurs in angle measuring system .	The instrument will return to previous mode automatically.
V angle measuring error	Displayed when the telescope rotated too fast or any abnormality occurs in angle measuring system.	The instrument will return to previous mode automatically.
E31	Displayed when the unit of the angle at the recall mode is different from the unit stored in setting mode.	Make the unit in same unit system.
E35	Displayed when REM measurement carried out to the range from zenith or nadir $\pm 6^\circ$ .	Operate in the range out of $\pm 6^\circ$ from the zenith or nadir.
E36	Displayed when the N.E coordinates are set same as the instrument coordinate in setting direction angle or lay out mode.	Set except the instrument coordinate value.
E60's	Any abnormality occurs with EDM (distance measuring system).	Repair is required.
E71	Displayed when Vertical angle 0 position is set with incorrect procedure.	Confirm the procedure and readjust.
E72	Displayed when Vertical angle -position is adjusted in wrong position.	Confirm the procedure and readjust
E73	The instrument was not leveled when Vertical angle 0-position is adjusted.	Level the instrument then carry the adjustment work.
E81 E82	Mainly at the time data transmission between GTS-820 series and external instrument.	Press [F1](EXIT) key, and confirm the connection cables are correct.
Other E80's	Data transmission error between internal P.C.B.'s.	Restart and confirm the operation procedure is correct.
E90's	Abnormality in internal memory system.	Repair is required.
E300's	Abnormality in tracking system.	Repair is required.
E600's	Abnormality in angle measuring system.	If this error code continues to display, repair is required.
E700's	Abnormality in angle measuring system.	If this error code continues to display, repair is required.
E800's	In the self checking mode, vibration is too big.	Get rid of the Vibration

- 1 If error still persist after attempting to clear them, contact your local Topcon dealer or Topcon head office.

## 19 SPECIAL ACCESSORIES

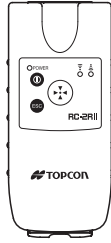

### Remote Control System RC-2II

Using together with RC-2II makes it possible to optical communication between the GTS-820A series and RC-2II. This gives easy operation for one man surveying.

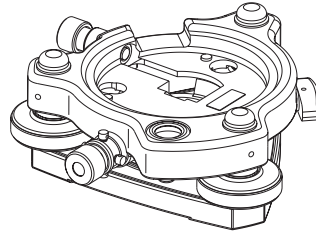

### Optical plummet tribrach TR-5P

This is detachable tribrach having built-in optical plummet telescope. (Compatible with Wild)

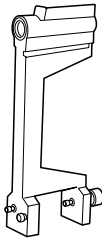

### Trough compass, Model 6

Shock proof construction. No clamp is necessary when carrying the instrument.

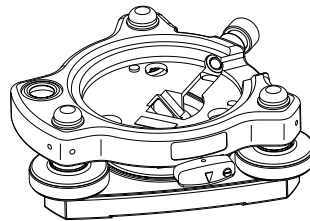

### Tribrach TR-5

This is detachable tribrach having tribrach fixing screw.

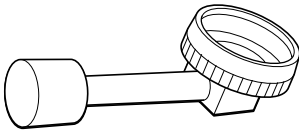

### Diagonal eyepiece, Model 10

Observation in an easy posture will be provided up to the zenith position

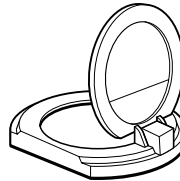

### Solar filter, Model 6

A filter designed exclusively for direct collimation of the sun. Solar filter of flap-up type.



### Solar reticle, Model 6

A reticle designed for collimation of the sun. Can be used together with Solar Filter.

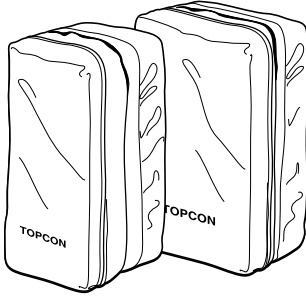

#### Prism unit case, Model 6

Fixed 9 prisms unit or tilting 3 prisms unit can be stored in this case. Especially, this is a very easy case to carry. Soft material is used.

- 1 External dimensions:  
250(L)×120(W)×400(H) mm
- 1 Weight:0.5kg

#### Prism unit case, Model 5

1 prisms unit or fixed 3 prisms unit can be stored in this case. Especially, this is a very easy case to carry. Soft material is used.

- 1 External dimensions:  
200(L)×200(W)×350(H) mm
- 1 Weight:0.5kg



#### Gadget case, Model 1

A case to store and carry accessories.

- 1 External dimensions:  
300(L)×145(W)×220(H) mm
- 1 Weight:1.4kg

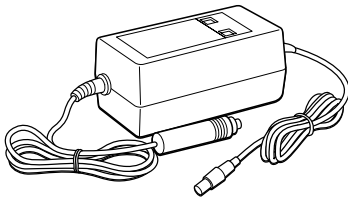

#### Cigarette battery charger BC-9 (for BT-3Q)

- 1 Input voltage:13.8V to 16V
- 1 Power consumption: 40VA approx.
- 1 Charging time:  
approx. 2 hour (+20°C) to charge BT-3Q
- 1 Operation temperature range:  
+10°C to +40°C (+50 to +104°F)
- 1 External dimensions:  
116(L)×60(W)×50(H) mm
- 1 Weight:0.3kg

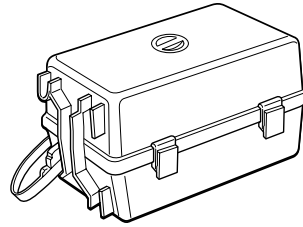

#### Prism unit case, Model 3

This is the plastic case to store and carry various sets of prisms.

The case covers one of the following prism sets:

- 1 Tilt single prism set
- 1 Tilt single prism set with a target plate
- 1 Fixed triple prism unit
- 1 Fixed triple prism unit with a target plate
- 1 External dimensions:  
427(L)×254(W)×242(H) mm
- 1 Weight:3.1kg

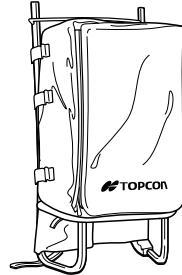

#### Back pack, Model 2

Convenient for use in mountainous terrain.

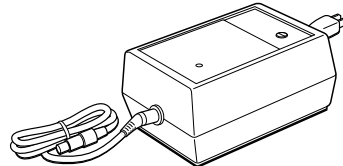

#### Battery charger BC-6 (for BT-3L)

- 1 Input voltage:100, 120, 220, 240V  
AC: ±10% 50/60 Hz
- 1 Power consumption: 15VA approx.
- 1 Charging time:  
approx. 15 hour (+20°C) to charge BT-3L
- 1 Operation temperature range:  
+10°C to +40°C (+50 to +104°F)
- 1 External dimensions:  
142(L) × 96(W) × 64(H) mm
- 1 Weight:1.0kg

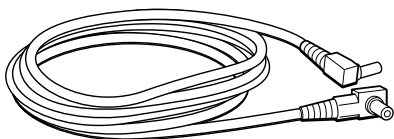

**Power cord PC-6 (For BT-3L, AC-6)**

- 1 L-shape plug provided
- 1 Cord length: 2m approx.

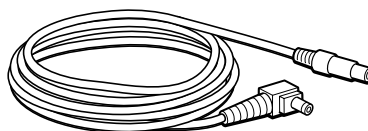

**Power cord PC-5**

- (For BT-3Q, AC-6 and TOPCON FC series Data collector)
- 1 L-shape plug provided
  - 1 Cord length: 2m approx.

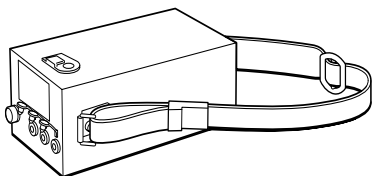

**Large capacity battery pack BT-3L**

- 1 Output voltage : DC 8.4V
- 1 Capacity: 6AH
- 1 External dimensions:  
190(L) × 106(W) × 74(H) mm
- 1 Weight: 2.8kg

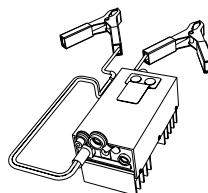

**Auto Converter AC-6**

- 1 Input voltage : DC12V
- 1 Output voltage : DC 8.4V±5%
- 1 Current rating : 3A
- 1 Connection cable length : Approx. 3m
- 1 External dimensions :  
100(L) × 50(W) × 52(H) mm
- 1 Weight : Approx. 300g

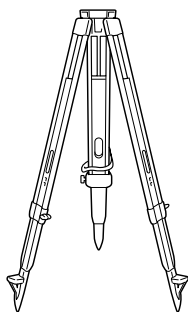

**Aluminum extension leg tripod, Type E**

- 1 Flat head 5/8" × 11 threads with adjustable legs.

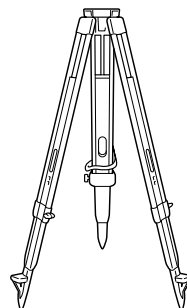

**Wide-frame extension leg tripod, Type E (Wood)**

- 1 Flat head 5/8" × 11 threads with adjustable legs.

**Prism sets**

See the description on Chapter 16 "PRISM SYSTEM"

**Data card**

Capacity	The number of Measurement Points
128 K bytes	Approx. 2,000 points
256 K bytes	Approx. 4,000 points
512 K bytes	Approx. 8,000 points

## 20 SPECIFICATIONS

### Telescope

Length	: 166mm
Objective lens	: 50mm (EDM 50mm)
Magnification	: 30×
Image	: Erect
Field of view	: 1°30'
Resolving power	: 3"
Minimum focus	: 1.3m
Focusing knob	: 1 speed way

### Automatic Tracking / Collimating

Maximum Automatic Tracking speed	: 12° /sec
Automatic Collimating area	: ±5°
Automatic Tracking range *1:	

Prism type 2, with 1 prism	8 to 800 m (26 to 2,625ft)
Prism Unit Type A2/A3/A3S	10 to 500 m (33 to 1,640ft)
Reflector tape (5cm× 5cm)	10 to 50 m (33 to 164 ft)

Automatic Collimation / Tracking accuracy	: 3" Standard deviation *2
Search pattern	: Pattern 1 / Pattern 2
Search range	: Any value can be set, able to set (1° step)
Safety standard for Laser Beam	: Class 1 (IEC Publication 825) Class II (FDA/BRH 21 CFR 1040)

\*1 Condition : Normal (Visibility about 20km), except high humidity time.

Automatic Tracking range of Reflector tape will differ depending on the kind of reflector tape.

\*2 The air condition is stable and prism is staying.

Automatic Collimation / Tracking accuracy is available only for prism use except for reflector tape.

### Manual Driving

Maximum rotating speed *	: 50° /sec
Coarse movement	: Shuttle driving (in 7 steps)
Fine movement	: Jog driving (minimum step about 1 second)

\*By reverse, rotating instruction

**Distance measurement**

## Measurement range

Prism	Atmospheric conditions	
	Condition 1	Condition 2
Mini prism	800m ( 2,600ft)	----
1 prism	2,200m (7,200ft)	2,500m (8,200ft)
3 prisms	2,800m (9,200ft)	3,200m (10,500ft)
9 prisms	3,600m (11,800ft)	4,200m (13,800ft)

Condition 1: Sight haze with visibility about 20km (12.5miles) moderate sunlight with light heat shimmer.

Condition 2: No haze with visibility about 40km(25 miles), overcast with no heat shimmer.

## Measurement accuracy

Fine measurement mode :  $\pm(2\text{mm} + 2\text{ppm} \times D)$  m.s.e.  
 Coarse measurement mode :  $\pm(10\text{mm} + 2\text{ppm} \times D)$  m.s.e.  
 D : Measuring distance (mm)

## Least Count in Measurement

Fine measurement mode : 1mm (0.005ft.) / 0.2mm (0.001ft)  
 Coarse (1mm) measurement mode : 1mm (0.005ft.)  
 Coarse (10mm) measurement mode : 10mm (0.02ft.)

## Measurement Display

: 10digit : max. display  $\pm 999999.9999\text{m}$

## Measurement Time

Fine measurement mode : 1mm : 1.2 sec. (Initial 4 sec.)  
 : 0.2mm: 2.8 sec. (Initial 5 sec.)  
 Coarse (1mm) measurement mode : 0.7sec. (Initial 3sec.)  
 Coarse (10mm) measurement mode : 0.4sec. (Initial 3sec.)  
 (The initial time will be different by a condition.)

## Atmospheric Correction Range

:  $-999.9\text{ppm}$  to  $+999.9\text{ppm}$  , in 0.1ppm increments

## Prism Constant Correction Range

:  $-99.9\text{mm}$  to  $+99.9\text{mm}$  , in 0.1 mm increments

## Coefficient Factor

: Meter / Feet  
 International feet 1meter = 3.2808398501 ft.  
 US SURVEY feet 1meter = 3.2808333333 ft.

## Ambient Temperature Range

:  $-20^{\circ}\text{C}$  to  $+50^{\circ}\text{C}$  ( $-4^{\circ}\text{F}$  to  $+122^{\circ}\text{F}$ )

**Electronic Angle Measurement**

## Method

: Absolute reading

## Detecting system

: Horizontal : 2 sides  
 Vertical : 2 sides

## Minimum reading

GTS-821A : 1"/0.5" (0.5mgon/0.1mgon, 5mmil/2mmil) reading  
 GTS-822A : 1"/0.5" (0.5mgon/0.1mgon, 5mmil/2mmil) reading  
 GTS-823A : 5"/1" (1mgon/0.2mgon, 20mmil/5mmil) reading  
 GTS-825A : 5"/1" (1mgon/0.2mgon, 20mmil/5mmil) reading

## Accuracy(Standard deviation based on DIN 18723 )

GTS-821A : 1" (0.3mgon )  
 GTS-822A : 2" (0.6mgon )  
 GTS-823A : 3" (1mgon )  
 GTS-825A : 5" (1.5mgon )

## Diameter of circle

: 71mm

**Tilt Correction**

Method	: Automatic vertical and Horizontal index : Liquid type
Compensating Range	: $\pm 4'$
Correction unit	: 1" (0.1 mgon)

**Others**

Instrument height	: 196mm (7.7 in) Base unit detachable (Height from the tribrach dish to the center of telescope)
-------------------	---

Level sensitivity	
Circular level	: 10'/2mm
Plate level	: 30"/2 mm

**Optical Plummet Telescope**

Magnification	: 3 ×
Focusing range	: 0.5m to infinity
Image	: Erect
Field of view	: 4°

**Optical communication**

Laser class	: Class 2 (Class II) laser product
-------------	------------------------------------

Dimension	: 325 (H) × 229 (W) × 211 (L) mm (12.8 (H) × 8.9 (W) × 8.3 (L) in)
-----------	---

**Weight**

GTS-820series	: 7.5kg ( 16.6 lbs)
Plastic carrying case	: 5.4kg ( 11.9 lbs)

**Durability**

Protection against water and dust	: IP54 (with BT-56Q) (Based on the standard IEC60529)
-----------------------------------	--

**Computer unit**

OS	: MS-DOS Ver.3.22
Internal Memory	
System memory	: FEEPROM 512KB
Main memory	: RAM 640 KB
Data memory	: FEEPROM 2 MB
Program memory	: FEEPROM 1 MB
Application program memory	: FEEPROM 2 MB

PC Card Slot	: Based on PC Card Standard 95 (Memory card or ATA card, Type I/II) Max. 32MB
--------------	---

**Display and keyboard**

GTS-821A	: Both sides
GTS-822A	: One side
GTS-823A	: One side
GTS-825A	: One side

**Rechargeable Battery BT-56Q (This battery does not contain mercury)**

Out put voltage : 7.2 V  
 Capacity : 4.0 Ah

Maximum operating time( when fully recharged) at +20°C (+68°F)

Normal use	about 3.5 hours
Distance and Angle measurement	about 6 hours

Weight : 0.4kg (0.9 lbs)

**Battery Charger BC-27BR / BC-27CR**

Input voltage : AC 120V(BC-27BR), AC 230V(BC-27CR)  
 Frequency : 50/60Hz  
 Recharging time (at +20°C /+68°F)  
     Rechargeable battery BT-56Q : Approx. 2.5 hours  
 Discharging time (at +20°C /+68°F)  
     Rechargeable battery BT-56Q : 12 hours (in case of full charge)  
 Operating temperature : +10°C to +40°C ( +50°F to 104°F)  
 Charging signal : Red lamp illumination  
 Refreshing signal : Yellow lamp illumination  
 Finishing signal : Green lamp illumination  
 Weight : 0.4kg (0.9 lbs)

- 1 Battery using time will vary depending on environmental conditions and operations done with GTS-820A series.



# APPENDIX

## 1 Dual Axis Compensation

Inclination of the vertical axis with respect to true vertical will result in incorrectly measured horizontal angles. The extent of the error in horizontal angle measurement due to axis tilt depends on three factors :

- 1 the amount of the tilt of axis
- 1 the elevation of the target
- 1 the horizontal angle between the direction of tilt of the vertical axis and the target.

These factors are related by the following formula :

$$Hz_{err} = v \cdot \sin \alpha \cdot \tan h$$

where  $v$  = tilt of axis in arcseconds

$\alpha$  = azimuth angle between vert. axis direction and target

$h$  = elevation of target

$Hz_{err}$  = error in horizontal angle

Example: When the vertical axis is tilted by 30 arcseconds, the target is  $10^\circ$  above the horizon and rotated  $90^\circ$  in azimuth from the direction of the vertical axis error.

$$Hz_{err} = 30'' \cdot \sin \alpha \cdot \tan 10^\circ$$

$$Hz_{err} = 30'' \cdot 1 \cdot 0.176326 = 5.29''$$

From the above example it can be seen that horizontal angle errors will increase with steeper vertical sights (tangent will increase as vertical angle increases) and will be at a maximum when the target is at right angles ( $\sin 90^\circ = 1$ ) to the direction of the vertical axis error. Errors will be at a minimum when the sights are nearly horizontal ( $h=0$ ,  $\tan 0=0$ ) and in the same direction as the vertical axis error ( $\alpha=0$ ,  $\sin 0=0$ ). Please refer to the table below to see the relationship between axis tilt ( $v$ ) and elevation ( $h$ ) and the error in horizontal angles which results from these factors.

$v$	$h$	$0^\circ$	$1^\circ$	$5^\circ$	$10^\circ$	$30^\circ$	$45^\circ$
0"	0"	0"	0"	0"	0"	0"	0"
5"	0"	0"	0.09"	0.44"	0.88"	2.89"	5"
10"	0"	0"	0.17"	0.87"	1.76"	5.77"	10"
15"	0"	0"	0.26"	1.31"	2.64"	8.66"	15"
30"	0"	0"	0.52"	2.62"	5.29"	17.32"	30"
1'	0"	0"	1.05"	5.25"	10.58"	34.64"	1'

It is clear from the table that dual axis compensation has the most benefit when the elevation of the target is greater than  $30^\circ$  and the axis is tilted more than  $10''$ . The entries indicated in bold in the table show, in fact, that for many common surveying applications i.e. target elevation  $<30^\circ$  and axis error  $<10''$ , virtually no correction would be required. Dual axis compensation is especially suited then for applications where the sights are very steep.

Even though the compensators can correct horizontal angles for vertical axis errors, ***it is still important to use care in setting up the instrument.***

Centering error, for instance, cannot be corrected by the compensators. If the vertical axis is tilted by  $1'$  with the instrument 1.4meters above the ground, a centering error of approx. 0.4mm will result. The maximum effect of this error at 10m is about  $8''$  of horizontal angle error.

In order to maintain the increased accuracy possible through dual axis compensation, it is necessary to keep the compensators in proper adjustment. The compensators must agree with the actual level condition of the instrument. Through various environmental stresses, the agreement between the level condition sensed by the compensators and the true level condition of the instrument may be disturbed. In order to reestablish the correct relationship between the compensator and the true level condition of the instrument, it is necessary to carry out the vertical indexing procedure listed on Section 9.4 "Adjustment of Compensation Systematic Error of Instrument". This adjustment will both reset the vertical index (cause a direct + indirect zenith reading to the same elevation to equal  $360^\circ$ ) and zero the level reference for the horizontal compensator. While correct vertical angles can be obtained by averaging direct and indirect reading even when the index is improperly adjusted, the same is not true for horizontal angles. Since the vertical axis error is fixed for a given setup, its effect cannot be removed by averaging two readings.

***For this reason, it is extremely important to maintain the vertical indexing adjustment to insure proper correction of the horizontal angles.***

## 2 Precaution when Charging or Storing Batteries

The capacity of battery will be affected and its service life shortened in any of the following cases while it is recharged, discharged or stored.

### 1) Recharging

Fig. 1 shows how ambient temperature at recharging is related to charging efficiency or as affecting discharge capacity. As seen from the figure, charging at normal temperature is best, and the efficiency decreases as the temperature rises. It is best, therefore, to always recharge the battery at normal temperature to obtain full use of battery capacity and enjoy maximum operation per charge. And the service life of your battery will be shortened if it is frequently overcharged or recharged at high temperature.

Note: 0.1C charge means that the battery is recharged with 0.1 -time current as against its capacity.

### 2) Discharge

Fig. 2 shows discharge temperature characteristics. Discharge characteristics at high temperature are the same as those at normal temperatures. The battery is likely to have reduced discharge capacity as well as lower discharged voltage when discharged at low temperature. And the service life of your battery will be shortened if it is greatly overcharged.

Note: 1C discharge means one with 1 -time current over battery capacity.

### 3) Storage

See Fig. 3 for how storing period at different temperature levels is related to the remaining capacity. The battery will lose its capacity as storage temperature rises and the storage period increases. This does not mean, however, that the battery performance is damaged when the battery is stored. The battery, reduced in capacity, will be restored once it is recharged. Always recharge your battery before use. And recharge and discharge the battery 3 or 4 times to restore its capacity if it has been stored for a long period or at high temperature. Storing at high temperature can adversely affect the service life of your battery.

Your battery has been fully charged before leaving the factory, but its capacity may be affected considerably when it takes several months to reach you, if it is stored at high temperature area or passes through a high-temperature region. Then, the battery must be recharged and discharged 3~4 times to fully restore its capacity.

And the battery should always be stored at normal temperature or lower if it will not be used for any long period. This helps your battery have a longer service life.

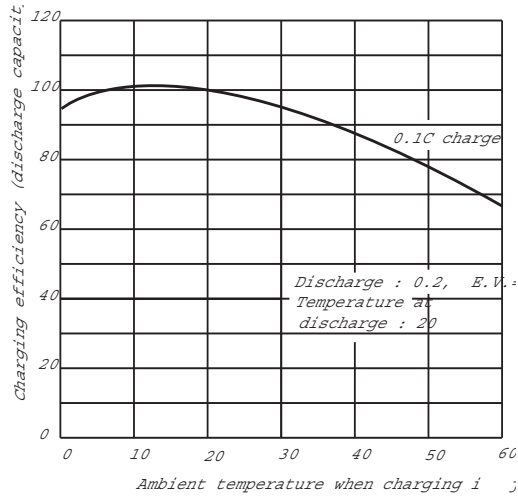

Fig.1 Recharging

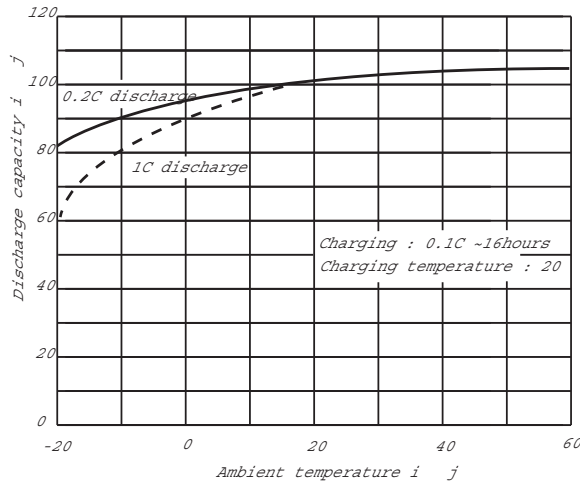

Fig. 2 Discharge

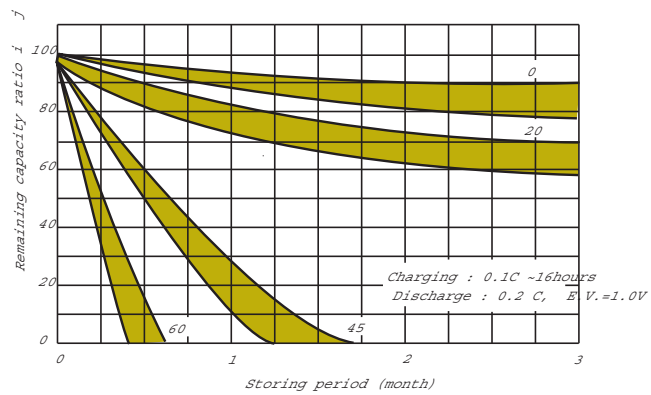

Fig. 3 Storage

## **END USER LICENSE AGREEMENT**

IMPORTANT-- READ CAREFULLY BEFORE USING THE EMBEDDED SYSTEM WHICH CONTAINS MICROSOFT SOFTWARE. By using the embedded system containing software, you indicate your acceptance of the following Software License Agreement.

### **SOFTWARE LICENSE AGREEMENT (Embedded Products)**

This software license agreement, including the Warranty and Special Provisions set forth in the appendix or separate booklet included in this package, is a legal agreement between you (either an individual or an entity, hereinafter "End User") and the manufacturer ("Embedded System Manufacturer") of the embedded system containing software product. By using the embedded system on which software program(s) have been pre installed ("SOFTWARE"), you are agreeing to be bound by the terms of this agreement.

1. **GRANT OF LICENSE.** This License Agreement permits you to use the Microsoft SOFTWARE as preinstalled on the embedded system.

2. **INTELLECTUAL PROPERTY.** GTS-820A SERIES contains intellectual property, i.e., software programs, that is licensed for the end user customer's use (hereinafter "End User"). This is not a sale of such intellectual property. The End User shall not copy, disassemble, reverse engineer, or decompile the software program.

3. **COPYRIGHT.** The SOFTWARE is owned by Microsoft Corporation or its suppliers and is protected by United States copyright laws and international treaty provisions and all other applicable national laws. Therefore, you must treat the SOFTWARE like any other copyrighted material.

4. **U.S. GOVERNMENT RESTRICTED RIGHTS.** The SOFTWARE and documentation are provided with RESTRICTED RIGHTS. Use, duplication, or disclosure by the United States Government is subject to restrictions as set forth in subparagraph (c)(1)(ii) of The Rights in Technical Data and Computer Software clause at DFARS 252.227-7013 or subparagraphs (c)(1) and (2) of the Commercial Computer Software -- Restricted Rights at 48 CFR 52.227-19, as applicable. Manufacturer is Microsoft Corporation/One Microsoft Way/Redmond, WA 98052-6399.

Please see the Warranty and Special Provisions for information concerning governing law.

Product support for the SOFTWARE is not provided by Microsoft Corporation or its subsidiaries. For product support, please refer to Embedded System Manufacturer's support number provided in the documentation for the embedded system. Should you have any questions concerning this Agreement, or if you desire to contact Embedded System Manufacturer for any other reason, please refer to the address provided in the documentation for your embedded system.

FOR THE LIMITED WARRANTY AND SPECIAL PROVISIONS PERTAINING TO YOUR COUNTRY, PLEASE REFER TO EMBEDDED SYSTEM DOCUMENTATION OR THE WARRANTY AND SPECIAL PROVISIONS BOOKLET INCLUDED IN THIS PACKAGE.

## **APPENDIX** **WARRANTY AND SPECIAL PROVISIONS**

### **LIMITED WARRANTY**

**LIMITED WARRANTY.** Embedded System Manufacturer warrants that (a) the SOFTWARE will perform substantially in accordance with the accompanying written materials for a period of ninety (90) days from the date of receipt. Any implied warranties on the SOFTWARE are limited to ninety (90) days. Some states/jurisdictions do not allow limitations on duration of an implied warranty, so the above limitation may not apply to you.

**CUSTOMER REMEDIES.** Embedded System Manufacturer's and its suppliers' entire liability and your exclusive remedy shall be, at Embedded System Manufacturer's option, either (a) return of the price paid, or (b) repair or replacement of the SOFTWARE that does not meet the above Limited Warranty and which is returned to Embedded System Manufacturer with a copy of your receipt. This Limited Warranty is void if failure of the SOFTWARE has resulted from accident, abuse, or misapplication. Any replacement SOFTWARE will be warranted for the remainder of the original warranty period or thirty (30) days, whichever is longer.

**NO OTHER WARRANTIES.** THE MICROSOFT SOFTWARE PROGRAMS ARE PROVIDED TO THE END USER "AS IS" WITHOUT WARRANTY OF ANY KIND, EITHER EXPRESSED OR IMPLIED, INCLUDING, BUT NOT LIMITED TO, WARRANTIES OF MERCHANTABILITY AND FITNESS FOR A PARTICULAR PURPOSE. THE ENTIRE RISK OF THE QUALITY AND PERFORMANCE OF THE SOFTWARE PROGRAM IS WITH YOU. **NO LIABILITY FOR CONSEQUENTIAL DAMAGES.** EMBEDDED SYSTEM MANUFACTURER'S AND ITS SUPPLIERS' SHALL NOT BE HELD TO ANY LIABILITY FOR ANY DAMAGES SUFFERED OR INCURRED BY THE END USER (INCLUDING, BUT NOT LIMITED TO, GENERAL, SPECIAL, CONSEQUENTIAL OR INCIDENTAL DAMAGES INCLUDING DAMAGES FOR LOSS OF BUSINESS PROFITS, BUSINESS INTERRUPTION, LOSS OF BUSINESS INFORMATION AND THE LIKE), ARISING FROM OR IN CONNECTION WITH THE DELIVERY, USE OR PERFORMANCE OF THE SOFTWARE PROGRAM.

### **SPECIAL PROVISIONS**

This Software License Agreement and Warranty are governed by the laws of the State of Washington, U.S.A.



**EMC NOTICE**

In industrial locations or in proximity to industrial power installations, this instrument might be affected by electromagnetic noise. Under such conditions, please test the instrument performance before use.

This is a CLASS A product. In a domestic environment this product may cause radio interference in which case the user may be required to take adequate measures.



# AUTO TRACKING TOTAL STATION

---

## GTS-820A series

---

### TOPCON POSITIONING SYSTEMS, INC.

5758 West Las Positas Blvd., Pleasanton, CA 94588, U.S.A.  
Phone: 925-460-1300 Fax: 925-460-1315 [www.topcon.com](http://www.topcon.com)

### TOPCON CALIFORNIA

3380 Industrial Blvd, Suite 105, West Sacramento, CA 95691, U.S.A.  
Phone: 916-374-8575 Fax: 916-374-8329

### TOPCON EUROPE B.V.

Essebaan 11, 2908 LJ Capelle a/d IJssel, The Netherlands.  
Phone: 010-4585077 Fax: 010-4585045 [www.topconeuropa.com](http://www.topconeuropa.com)

### IRELAND OFFICE

Unit 69 Western Parkway Business Center  
Lower Ballymount Road, Dublin 12, Ireland  
Phone: 01460-0021 Fax: 01460-0129

### TOPCON DEUTSCHLAND G.m.b.H.

Giesslerallee 31, 47877 Willlich, GERMANY  
Phone: 02154-885-100 Fax: 02154-885-111 [info@topcon.de](mailto:info@topcon.de)  
[www.topcon.de](http://www.topcon.de)

### TOPCON S.A.R.L.

89, Rue de Paris, 92585 Clichy, Cedex, France.  
Phone: 33-1-41069490 Fax: 33-1-47390251 [topcon@topcon.fr](mailto:topcon@topcon.fr)

### TOPCON ESPAÑA S.A.

Frederic Mompou 5, ED. Euro 3, 08960, Sant Just Desvern, Barcelona, Spain.  
Phone: 93-473-4057 Fax: 93-473-3932 [www.topconesp.com](http://www.topconesp.com)

### TOPCON SCANDINAVIA A. B.

Neongatan 2 S-43151 Mölndal, SWEDEN  
Phone: 031-7109200 Fax: 031-7109249

### TOPCON (GREATBRITAIN) LTD.

Topcon House Kennet Side, Bone Lane, Newbury, Berkshire RG14 5PX U.K.  
Phone: 44-1635-551120 Fax: 44-1635-551170  
[survey.sales@topcon.co.uk](mailto:survey.sales@topcon.co.uk) [laser.sales@topcon.co.uk](mailto:laser.sales@topcon.co.uk)

### TOPCON SOUTH ASIA PTE. LTD.

Blk 192 Pandan Loop, #07-01 Pantech Industrial Complex, Singapore 128381  
Phone: 62780222 Fax: 62733540 [www.topcon.com.sg](http://www.topcon.com.sg)

### TOPCON AUSTRALIA PTY. LTD.

408 Victoria Road, Gladesville, NSW 2111, Australia  
Phone: 02-9817-4666 Fax: 02-9817-4654 [www.topcon.com.au](http://www.topcon.com.au)

### TOPCON INSTRUMENTS (THAILAND) CO., LTD.

77/162 Sinn Sathorn Tower, 37th Fl.,  
Krungdhonburi Rd., Klongtongnai, Klongsarn, Bangkok 10600 Thailand.  
Phone: 02-440-1152-7 Fax: 02-440-1158

### TOPCON INSTRUMENTS (MALAYSIA) SDN. BHD.

Excella Business Park Block C, Ground & 1st Floor, Jalan Ampang Putra,  
Taman Ampang Hilir, 55100 Kuala Lumpur, MALAYSIA  
Phone: 03-42701068 Fax: 03-42704508

### TOPCON KOREA CORPORATION

2F Yooseoung Bldg., 1595-3, Seocho-Dong, Seocho-gu, Seoul, 137-876, Korea.  
Phone: 82-2-2055-0321 Fax: 82-2-2055-0319 [www.topcon.co.kr](http://www.topcon.co.kr)

### TOPCON OPTICAL (H.K.) LIMITED

2/F., Meeco Industrial Bldg., No. 53-55 Au Pui Wan Street, Fo Tan Road,  
Shatin, N.T., Hong Kong  
Phone: 2690-1328 Fax: 2690-2221 [www.topcon.com.hk](http://www.topcon.com.hk)

### TOPCON CORPORATION BEIJING OFFICE

Room 8A Poly Plaza Building, 14 Dongzhimen Nandajie,  
Dongcheng District, Beijing, 100027, China  
Phone: 10-6501-4191-2 Fax: 10-6501-4190

### TOPCON CORPORATION BEIRUT OFFICE

P. O. BOX 70-1002 Antelias, BEIRUT-LEBANON.  
Phone: 961-4-523525/961-4-523526 Fax: 961-4-521119

### TOPCON CORPORATION DUBAI OFFICE

C/O Atlas Medical FZCO., P. O. Box 54304, C-25, Dubai Airport Free Zone, UAE  
Phone: 971-4-2995900 Fax: 971-4-2995901

---

## TOPCON CORPORATION

75-1 Hasunuma-cho, Itabashi-ku, Tokyo 174-8580, Japan  
Phone: 3-3558-2520 Fax: 3-3960-4214 [www.topcon.co.jp](http://www.topcon.co.jp)