

INSTRUCTION MANUAL

6", 8", 10", & 12.5" Starfinder
Dobsonian Telescopes



Meade Instruments Corporation

☀ **WARNING!** ☀

Never use the Starfinder Dobsonian telescope to look at the Sun! Looking at or near the Sun will cause *instant* and *irreversible* damage to your eye. Eye damage is often painless, so there is no warning to the observer that damage has occurred until it is too late. Do not point the telescope or its viewfinder at or near the Sun. Do not look through the telescope or its viewfinder as it is moving. Children should always have adult supervision while observing.

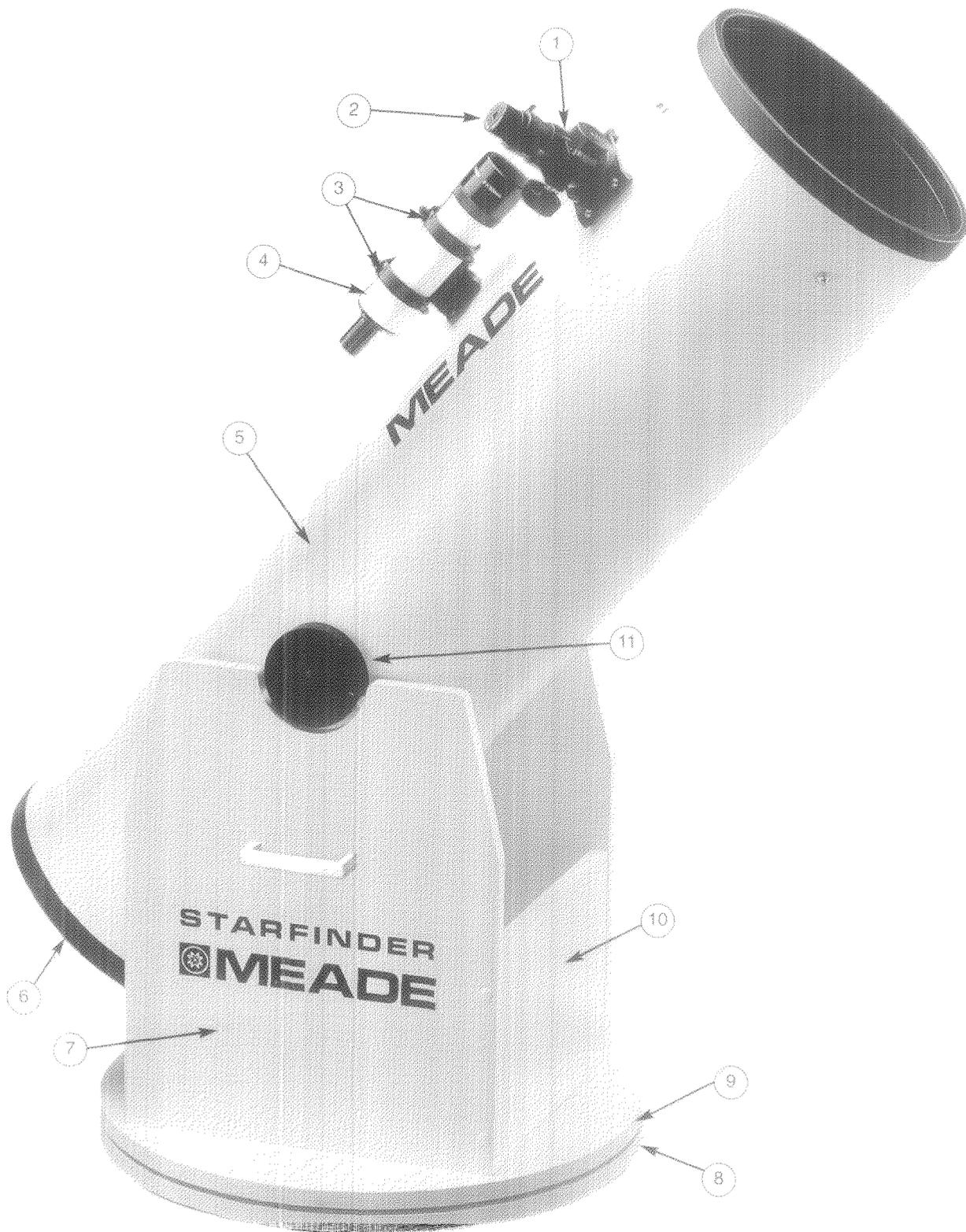

Fig. 1: The Meade Starfinder Dobsonian Telescope.

Captions for Fig. 1

- 1. **Focuser assembly**
- 2. **Eyepiece**
- 3. **Viewfinder bracket**
- 4. **Viewfinder**
- 5. **Optical tube assembly**
- 6. **Mirror cell**
- 7. **Side board**
- 8. **Ground plate**
- 9. **Base plate**
- 10. **Front board**
- 11. **Altitude bearing**

Contents

**6", 8" 10", and 12.5 Starfinder
Dobsonian Telescopes**

Introduction	4
Parts Listing and Assembly	4
Assembling the Mount	4
Optical Tube Assembly	5
Attaching the Focuser	5
Attaching the Viewfinder	5
Installing the Primary Mirror	5
Balancing the Telescope	6
The Viewfinder	6
Aligning the Viewfinder	6
Using the Viewfinder	6
Collimation of the Optical System	6
Correct Collimation	7
Spider Vane Adjustments	7
Secondary Mirror Adjustments	7
Primary Mirror Adjustments	7
Star Testing the Collimation	8
Tips on Using a Dobsonian Telescope	8
Magnification	8
Seeing Conditions	9
Observing Guidelines	9
Care of Optics and Main Tube	9
Optional Accessories	9
Meade Customer Service	9
Specifications and Features	10

® The name 'Meade' and the Meade logo are trademarks registered with the U.S. Patent Office and in principal countries throughout the world.

INTRODUCTION

The Starfinder Dobsonian telescope will open up the skies for a breathtaking array of visual observations. Galaxies, nebulae, star clusters — in all their variations of form, color, and extent — as well as the Moon, planets, comets and other objects within the solar system, may be studied in great detail.

This manual is designed for the 6", 8", 10", and 12.5" Starfinder Dobsonian Telescopes. With the exception of a few assembly operations and features, the four telescopes are almost identical operationally. When differences in procedures occur, they are clearly noted. Most standard and optional accessories are interchangeable between the four telescopes. For optimal enjoyment of the telescope, please take a few minutes to read this manual and become familiar with all of the instrument's capabilities.

PARTS LISTING AND ASSEMBLY

When first opening the packing boxes, note carefully the following parts included with the Starfinder Dobsonian Telescope (use Figure 1 and 2 to aid in the identification process):

Carton #1: The Telescope

- Optical tube assembly
- Primary mirror mounted in its cell
- Focuser
- Modified Achromat (MA) 25mm eyepiece
- 5 x 24mm viewfinder
- Hardware kit.

CAUTION: The primary mirror must be handled with special care. Never touch its reflective surface or place the mirror where it could be damaged. Save all original packing materials; if it is ever necessary to ship the telescope, these materials will help to assure that no shipping damage will occur.

Carton #2: The Mount

- 2 Side boards
- Front board
- Ground plate
- Base plate
- 2 Handles
- Hardware kit

Assembling the Mount

Assembly of your Meade Starfinder Dobsonian telescope should only take a few minutes. A phillips screwdriver, pliers, and an adjustable wrench are the only tools you will need.

1. Attach the self-adhesive rubber feet (11, Fig. 2) to the underside of the ground plate (10, Fig. 2), the round piece with the Teflon pads. The feet should be mounted directly under the already installed Teflon pads.

Two extra rubber feet have been supplied for use as "bumpers" where the telescope tube hits the front board (5, Fig. 2.) at the travel limits. Place one in the center of the top ledge, and one in the center on the inside near the bottom (see Fig. 2). The exact position for these two bumpers will be obvious with the telescope mounted on the base.

2. Attach the front board (5, Fig. 2) loosely to the two side boards (4, Fig. 2) using the supplied wood screws (3, Fig. 2), and the predrilled holes. Do not fully tighten the screws yet.
3. Attach the front board/side board assembly to the base plate (7, Fig. 2) using the supplied Wood Screws, and the predrilled holes. Snugly tighten all screws, including those previously installed.

CAUTION: Do not overtighten the wood screws. The screws should be tightened sufficiently so that the head of the screw is flush with the wood surface.

4. Firmly press the screw cover caps (2, Fig. 2) into the heads of the wood screws on the side boards. You may have to lightly tap the screw cover caps to properly seat them into the screw heads.
5. Install the two handles (1, Fig. 2) onto the side boards utilizing the supplied screws. Firmly tighten the screws.
6. To install the center pivot bearing, first insert the nylon center bearing bushing (8, Fig. 2) into the center hole of the ground plate (10, Fig. 2) from the top side. You may have to lightly tap the bushing to fully seat it into the hole.
7. Place the four (six on the 12.5" model) nylon washers (9, Fig. 2) onto the nylon center bearing bushing. Then, from the bottom, insert the 2 1/4" x 5/16" hex pivot bolt (12, Fig. 2), with a flat washer (13, Fig. 2) up through the center of the ground plate. This bolt should then be inserted through the center hole of the base plate (7, Fig. 2). Secure this assembly with the other flat washer and the 5/16" locking nut (6, Fig. 2).

NOTE: Do not overtighten the nut or the base plate will not easily rotate upon the ground plate. Only tighten the pivot bolt and nut sufficiently to maintain a very light pressure between the ground plate and base plate. The two parts should easily turn in a "Lazy Susan" fashion.

This completes assembly of your Meade Starfinder Dobsonian Mount.

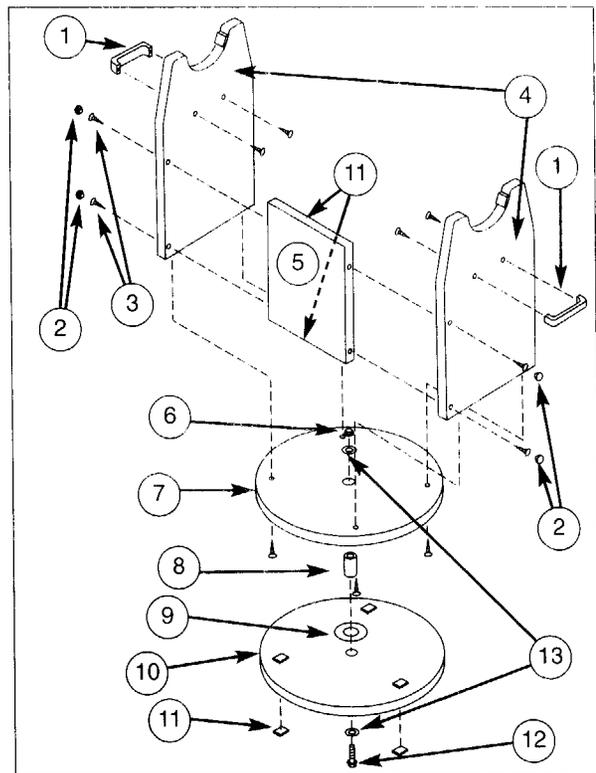

Fig. 2: Construction of the Dobsonian Mount. (1) Handle; (2) Screw Cover Caps; (3) Wood Screws; (4) Side Boards; (5) Front Board; (6) 5/16" Locking Nut; (7) Base Plate; (8) Center Bearing Bushing; (9) Nylon Washer; (10) Ground Plate; (11) Rubber Foot; (12) 2 1/4" x 5/16" Hex Pivot Bolt; (13) Flat Washers.

Optical Tube Assembly

The optical tube has been pre-drilled at the Meade factory to accept all standard accessories.

1. **Attaching the Focuser:** Lay the tube flat on the floor. Align the holes in the focuser assembly (1, Fig. 1) with the four pre-drilled holes in the optical tube. From the provided hardware, place the four Phillips-head screws through the holes. Then, carefully reach into the optical tube and attach a nut and washer to each screw. Tighten the screws, but do not overtighten; tightening to a firm feel is sufficient.
2. **Attaching the Viewfinder:** With the optical tube lying flat on the floor, align the two holes in the viewfinder bracket (3, Fig.1) with the pre-drilled holes in the optical tube. From the supplied hardware, place a screw through each of the holes. Carefully reach into the optical tube and attach a nut to each screw. As with the focuser, tightening to a firm feel is sufficient. Overtightening may result in damage to the tube's finish. Aligning the viewfinder is discussed later in this manual.

Your Meade Starfinder telescope was fully assembled, aligned, and tested at the Meade factory. To ensure safe shipping, the primary mirror was then removed from the telescope. Locate the primary mirror cell assembly (Fig 3). Again, take extreme care not to touch or bump the primary mirror.

3. **Installing the Primary Mirror:** (Refer to Figure 3) You will note that there is a colored marker on the rear of the telescope tube. There is a corresponding colored marker (3, Fig. 3) on the mirror cell. Carefully slide the mirror cell into the rear of the tube, ensuring that the two colored markers line up. Secure the cell to the tube with the four provided large-headed screws (1, Fig. 3). Again, do not overtighten the screws. A firm feel is sufficient.
4. Carefully place the assembled optical tube into the previously assembled base as illustrated in Figure 1. Note that the two large bearings on the side of the tube (11, Fig. 1) rest in the cutouts of the mount. Also note the orientation of the tube to the mount; the focuser (1, Fig. 1) should be on the opposite side from the mount's Front Board (10, Fig. 1).

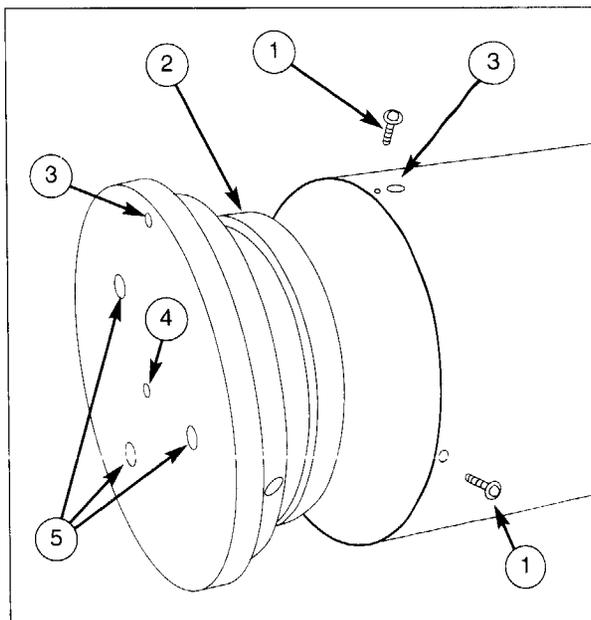

Fig. 3: Installing the Primary Mirror in the Optical Tube Assembly. (1) Attachment Bolts; (2) Primary Mirror; (3) Alignment Markers; (4) Counterweight Thread; (5) Collimation Bolts.

BALANCING THE TELESCOPE

Dobsonian telescopes are designed to move easily, but at the same time remain in the position they are placed. This is achieved by carefully balancing the telescope at the Meade factory. The telescope is balanced for standard accessories.

However, should anything attached to the telescope change, for example using a larger or smaller eyepiece, or even moving the primary mirror during collimation, slight imperfections in balance may occur.

You may find as you change eyepieces or accessories, that the telescope is out-of-balance. This is a relatively easy problem to correct. With a little ingenuity, counterweights can be fashioned by the telescope owner, using fishing sinkers or washers.

THE VIEWFINDER

The Starfinder telescope, as with almost all astronomical telescopes, presents a fairly narrow field of view to the observer. As a result, it is sometimes difficult to locate and center objects in the telescope's field of view.

The viewfinder, by contrast, is a low-powered, wide-field sighting scope with crosshairs that enables the easy centering of objects in the main telescope's field of view. Standard equipment with the Starfinder telescope is a viewfinder of 5-power and 24 mm aperture, called an "5 x 24mm viewfinder."

Aligning the Viewfinder

In order for the viewfinder to be useful, it must first be aligned with the main telescope, so that both the viewfinder and the main telescope are pointing at precisely the same place. To align the viewfinder, follow this procedure:

1. The viewfinder bracket includes six alignment screws. Turn the three rear-most alignment screws so that the viewfinder tube is roughly centered within the viewfinder bracket, as viewed from the eyepiece-end of the telescope.
2. Using the standard equipment 25mm eyepiece, point the main telescope at some easy-to-find, well-defined land object, such as the top of a telephone pole. Center the object precisely in the main telescope's field.
3. While looking through the viewfinder, gently turn one or more of the three front-most viewfinder alignment screws until the crosshairs of the viewfinder point at precisely the same position as the main telescope. During this procedure, occasionally look through the main telescope to make sure the object is still centered.

When the object is centered in the viewfinder, confirm that the viewfinder's crosshairs and the main telescope are now pointing at precisely the same object. The viewfinder is now aligned to the main telescope. Unless the alignment screws are disturbed, the viewfinder will remain aligned indefinitely.

Using the Viewfinder

Now, to locate any object, terrestrial or astronomical, first center the object on the crosshairs of the viewfinder; the object will then be centered in the field of the main telescope.

Note: If you intend to use higher observing magnifications, first locate, center, and focus the object using a low-power eyepiece (e.g., the 25mm eyepiece). Objects are easier to locate and center at low powers; higher power eyepieces may then be employed by changing eyepieces.

COLLIMATION OF THE OPTICAL SYSTEM

Precise collimation, or alignment, of your telescope's optical system is essential for good performance. All Meade telescopes are accurately collimated at the factory prior to shipment, so collimation adjustments will probably not be necessary. Nevertheless, take the time now to familiarize yourself with the following collimation procedure so that you may recognize a properly collimated instrument and adjust the collimation yourself, if necessary.

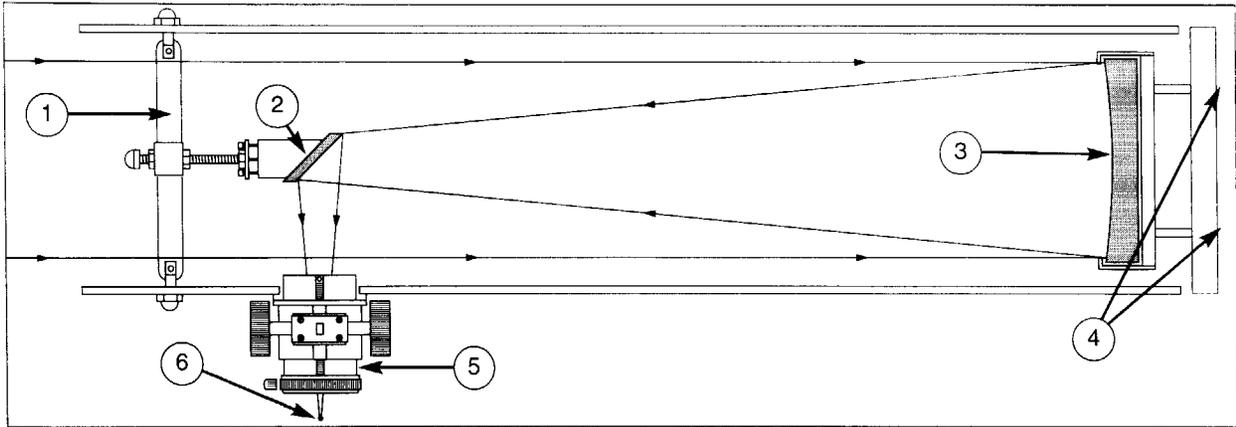

Fig. 4: Newtonian Reflecting Telescope. (1) Spider Vanes; (2) Secondary Mirror; (3) Parabolic Primary Mirror; (4) Primary Mirror Hex Screws; (5) Focuser Drawtube; (6) Focused Image.

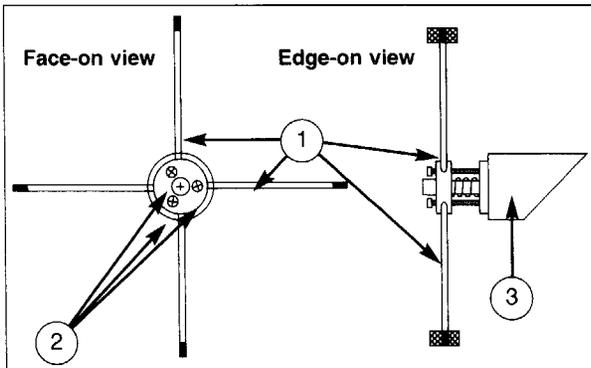

Fig. 5: Secondary Mirror Assembly. (1) Spider Vanes; (2) Tilt Screws; (3) Secondary Mirror Holder.

Correct Collimation

A properly collimated (aligned) mirror system in your Starfinder Dobsonian telescope assures the sharpest images possible. Your Starfinder is properly aligned when the primary mirror

(3, Fig. 4) and secondary mirror (2, Fig. 4) are tilted so that the focused image (6, Fig. 4) falls directly through the center of the focuser drawtube (5, Fig. 4).

To inspect the view of the mirror collimation, remove the eyepiece and look down the focuser drawtube. The round edge of the focuser drawtube (1, Fig. 6) will frame the reflections of the primary mirror with the secondary mirror (2, Fig. 6) the spider vanes (3, Fig. 6) and your eye (4, Fig. 6). Properly aligned, all of these reflections will appear concentric (*i.e.* centered) as illustrated in Fig. 6. Any deviation from the concentric reflections will require adjustments to the secondary mirror assembly (Fig. 5), and/or the primary mirror cell.

Spider Vane Adjustments

Looking down the open end of the telescope tube, check to see if the secondary mirror system is centered in the optical tube. If the assembly is off-center, loosen one of the spider vane adjustment/lock knobs while unscrewing the opposite knob. Only make adjustments to 2 knobs at a time until the secondary mirror is centered in the drawtube. When the spider vane is correctly positioned, the view through the drawtube will look like

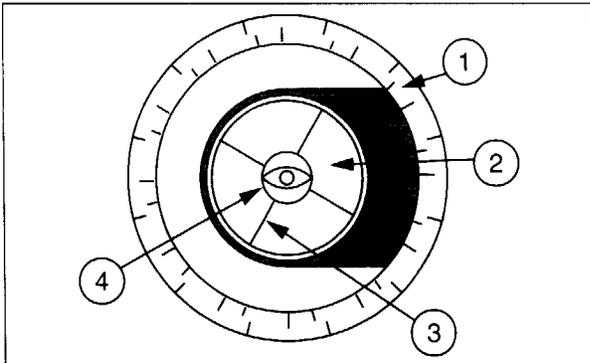

Fig. 6: Correct Collimation. (1) Round Edge of Focuser Drawtube; (2) Secondary Mirror; (3) Spider Vanes; (4) Eye.

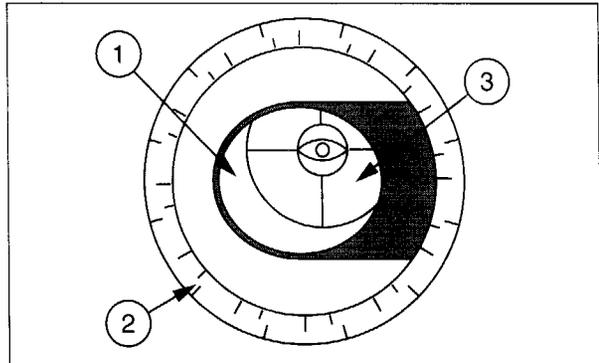

Fig. 8: Secondary Mirror Misalignment. (1) Secondary Mirror; (2) Round Edge of Focuser Drawtube; (3) Reflection of Primary Mirror.

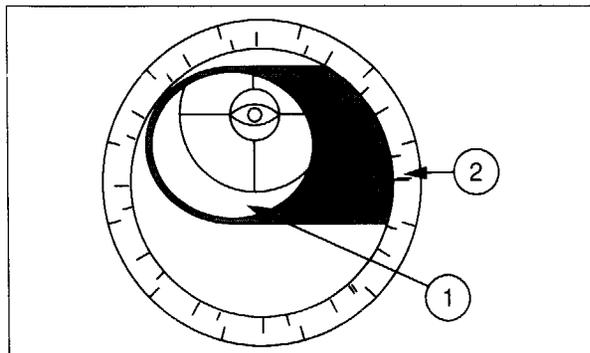

Fig. 7: Spider Vane Misalignment. (1) Secondary Mirror; (2) Round Edge of Focuser Drawtube.

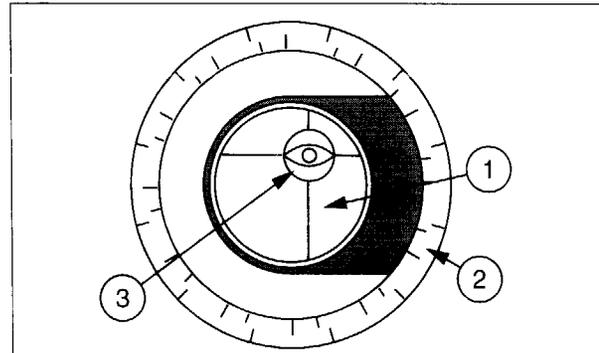

Fig. 9: Primary Mirror Misalignment. (1) Secondary Mirror; (2) Round Edge of Focuser Drawtube; (3) Eye.

Fig. 8. (Note that the secondary mirror is misaligned.)

Secondary Mirror Adjustments

If the secondary mirror (1, Fig. 8) is centered in the drawtube (2, Fig. 8) but the primary mirror is only partially visible in the reflection (3, Fig. 8) the 3 hex screws located on the secondary mirror assembly (2, Fig. 5) must be unthreaded slightly to refine the tilt-angle of the secondary mirror until the entire primary mirror can be seen centered within the secondary mirror reflection. When the secondary mirror is correctly aligned, it will look like Fig. 9. (Note that the primary mirror is misaligned.)

Primary Mirror Adjustments

If the secondary mirror and the reflection of the primary mirror (1, Fig. 9) appear centered within the drawtube (2, Fig. 9) but the reflection of your eye (3, Fig. 9) appears off-center, you will need to adjust one or more of the three primary mirror hex screws of the primary mirror cell. These primary hex screws are located behind the primary mirror, at the lower end of the main tube. Adjust the primary mirror alignment by slightly turning one hex screw at a time, looking through the focuser after each adjustment to determine if the mirror is moving in the correct direction.

Star Testing the Collimation

With the collimation performed, the next step is to test the accuracy of the alignment on a star. Use the 25mm eyepiece and point the telescope at a moderately bright (second or third magnitude) star, then center the star image in the telescope's field-of-view. With the star centered, follow the method below:

1. Bring the star image slowly out of focus until one or more rings are visible around the central disc. If the collimation was performed correctly, the central star disk and rings will be concentric circles, with a dark spot dead center within the out-of-focus star disk (this is the shadow of the secondary mirror), as shown in Fig. 10A. (An improperly aligned telescope will reveal elongated circles, Fig. 10B, with an off-center dark shadow.)
2. If the out-of-focus star disk appears elongated (Fig. 10B), you will need to adjust the primary mirror tilt hex screws of the primary mirror cell. Adjust the hex screw on the mirror cell until the circles are concentric on either side of focus.

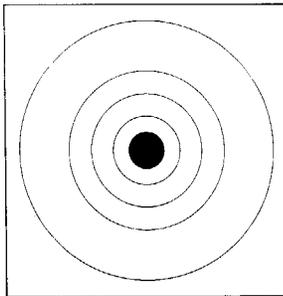

Fig. 10A.

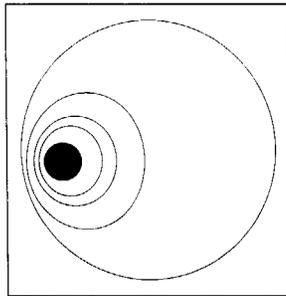

Fig. 10B.

TIPS ON USING A DOBSONIAN TELESCOPE

1. Never lubricate the Teflon pads on the ground plate. The Meade Starfinder Dobsonian has been designed with some inherent friction. You want the telescope to move easily when you position it, but you also want it to stay in the position you place it. Using any kind of oil, silicone spray, wax, or grease will ruin the performance by causing the telescope to move too easily. Just keep these bearing surfaces clean; that's all the maintenance required.
2. The altitude bearing surfaces (11, Fig 1) of the telescope are lightly lubricated at the factory for optimum performance. Over a period of time, these surfaces may become dry or dirty. Simply clean off the bearing surfaces with a dry cloth or paper towel and reapply a thin coating of silicone grease or spray to the surfaces to maintain peak performance. Do not use solvents or alcohol-based

cleaning solutions as this may damage the bearings or the painted surfaces of the telescope.

3. You will notice that your telescope will move in altitude by raising and lowering the tube, and in azimuth by rotating the base. As you observe objects in the night sky they will appear to drift out of the field of view due to the Earth's rotation. To keep an object centered in the field of view, just lightly nudge the telescope in the proper direction. This may take a little practice at first, but you'll soon get the hang of it.
4. Be sure the Mount is placed on a relatively level surface to allow proper operation. Each of the three feet should be in firm contact and not wobble. If you are in an area with particularly rough or soft ground, it may be helpful to place the Mount on a thick piece of plywood.
5. Part of the fun of using a Dobsonian type of telescope is the challenge of hunting for objects in the night sky. Invest in some simple star charts and books that tell you how to locate objects using a technique called "star hopping." Once you begin learning the star patterns and constellations, you're well on your way to finding many amazing sights.

MAGNIFICATION

The magnification, or power, at which a telescope is operating is determined by two factors: the focal length of the eyepiece employed and the focal length of the telescope. The Meade Starfinder Dobsonian telescope is supplied with one eyepiece as standard equipment. The focal length of the eyepiece, 25mm, is printed on its side.

Telescope focal length is, roughly speaking, the distance that light travels inside the telescope before reaching a focus.

The focal length of the Dobsonian 6" f/8 = 1220mm.

The focal length of the Dobsonian 8" f/6 = 1220mm.

The focal length of the Dobsonian 10" f/4.5 = 1140mm

The focal length of the Dobsonian 12.5" f/4.8= 1525mm

On a given telescope, such as the Starfinder Dobsonian, different eyepiece focal lengths are used to achieve different magnifications, from low to high.

To calculate the magnification obtained with a given eyepiece, use this formula:

$$\text{Power} = \frac{\text{Telescope Focal Length}}{\text{Eyepiece Focal Length}}$$

Example: Using the 25mm eyepiece supplied with the 8" f/6, the power is:

$$\text{Power} = \frac{1220\text{mm}}{25\text{mm}} = 49\text{x}$$

The type of eyepiece, whether Modified Achromatic, Plössl, or Super Plössl, has no effect on magnification, but does have a bearing on such optical characteristics as field of view, flatness of field, and color correction.

Maximum practical magnification is about 50X per inch of aperture. Generally, however, lower powers will produce higher image resolution. When unsteady air conditions prevail (as witnessed by rapid "twinkling" of the stars), extremely high powers result in "empty" magnification, where the object detail observed is actually diminished by the excessive power.

When beginning observations on a particular object, start with a low power eyepiece; get the object well-centered in the field of view and sharply focused. Then try the next step up in magnification. If the image starts to become fuzzy as you work up into higher magnifications, then back down to a lower power: the atmospheric steadiness is not sufficient to support high powers at the time you are observing. Keep in mind that a bright, clearly resolved, but smaller, image will show far more

detail than a dimmer, poorly resolved, larger image.

Because of certain characteristics of the human eye (in particular, eye pupil diameter) and because of optical considerations inherent in the design of the telescope, there exist minimum practical power levels also. Generally speaking the lowest usable power is approximately 4X per inch of telescope aperture.

SEEING CONDITIONS

Even in normal city conditions, with all of the related air and light pollution, there are many interesting celestial objects to observe. But, to be sure, there is no substitute for the clear, dark, steady skies generally found only away from urban environments, or on mountaintops: objects previously viewed only in the city take on added detail or are seen in wider extension, or even become visible at all for the first time.

The amateur astronomer is faced typically with two broadly defined problems when viewing astronomical objects through the Earth's atmosphere: first is the clarity, or transparency, of the air, and secondly the steadiness of the air. This latter characteristic is often referred to as the quality of "seeing." Amateur astronomers talk almost constantly about the "seeing conditions," since, perhaps ironically, even the clearest, darkest skies may be almost worthless for serious observations if the air is not steady. This steadiness of the atmosphere is most readily gauged by observing the "twinkling" of the stars: rapid twinkling implies air motion in the Earth's atmosphere, and under these conditions, resolution of fine detail (on the surface of Jupiter, for instance) will generally be limited. When the air is steady, stars appear to the naked eye as untwinkling points of unchanging brightness, and it is in such a situation that the full potential of the telescope may be realized: higher powers may be used to advantage, closer double stars resolved as distinct points, and fine detail observed on the Moon and planets.

OBSERVING GUIDELINES

Several basic guidelines should be followed for best results in using your telescope:

1. Try not to touch the eyepiece while observing. Any vibrations resulting from such contact will immediately cause the image to move.
2. Allow your eyes to become "dark-adapted" prior to making serious observations. Night adaptation generally requires about 10-15 minutes for most people.
3. Let the telescope "cool down" to the outside environmental temperature before making observations. Differences in temperature between a warm house and the cold outside air require about 30 minutes for the telescope's optics to regain their true correct figures. During this period the telescope will not perform well.
4. If you wear glasses and do not suffer from astigmatism, take your glasses off when observing through the telescope. You can re-focus the image to suit your own eyes. Observers with astigmatism, however, should keep their glasses on, especially with lower powered eyepieces. The effects of astigmatism are reduced with higher power eyepieces, so eyeglasses may be removed to improve eye relief.
5. Avoid setting up the telescope inside a room and observing through an open window (or, worse yet, through a closed window!). The air currents caused by inside/outside temperature differences will make quality observing impossible.
6. Perhaps most important of all, avoid "overpowering" your telescope. The maximum usable magnification at any given time is governed by the seeing conditions. If the telescopic image starts to become fuzzy as you increase in power, drop down to a reduced magnification. A smaller, but brighter and sharper, image is far more preferable to a larger, but fuzzy, indistinct one.

As you use your telescope more and more, you will find that you are seeing more and finer detail: observing through a large-aperture telescope is an acquired skill. Celestial observing will become increasingly rewarding as your eye becomes better trained to the detection of subtle nuances of resolution.

CARE OF OPTICS AND MAIN TUBE

With the reasonable care due any fine instrument, your Meade telescope will last a lifetime. If the eyepieces become dirty, try cleaning them with a camel's hair brush or compressed air. If you must wipe the surface of the lenses, do so gently with a soft cloth so as not to scratch the protective coatings.

The aluminum coating on the primary and secondary mirrors may last more than ten years without significant deterioration. (The coatings will last a shorter period if regularly exposed to salty or polluted air.) Minor blemishes, scratches, or streaks will NOT impair the telescope's performance. Re-coating, when necessary, is relatively inexpensive. Contact your local Meade dealer for information on mirror re-coating services.

The most common error is to clean the optics too often. If cleaning does become necessary, clean as follows:

1. Using distilled water and cotton, gently swab the surface of the mirror to remove any dust or dirt. Use the cotton to make one pass over the mirror and then use new cotton. This will keep the dirt previously removed from contacting the mirror surface and scratching the coatings.
2. Dip a wad of cotton in a mild detergent solution (1/2 teaspoon to 1 pint of water) and gently swab the entire surface. This will remove any oily deposits or fingerprints.
3. Swab the entire surface. Do not turn over the cotton wads or dissolved skin oils may deposit on the mirror's surface. Immediately take a dry swab and continue wiping the entire surface gently. Keep changing wads until the mirror surface is completely dry and free of streaks.

When cleaning the outside of the Starfinder optical tube (1), use a mild detergent, (Pine-Sol, Formula 409, Fantastic, or oil soap). Oil soap is preferred as it also acts as a preservative for the paint. Solvent or alcohol-based cleaning solutions will diminish the original luster of the paint.

OPTIONAL ACCESSORIES

A wide assortment of professional Meade accessories is available for the Starfinder telescopes.

Dust Covers: Snug-fitting vinyl dust covers protect optics from outside dust during storage of the telescope.

Eyepieces: Many additional eyepieces are available for higher and lower magnifications. All Meade Starfinder Equatorial telescopes accept standard 1.25" O.D. eyepieces as well as 2" O.D. eyepieces.

Meade Super Plössl (SP), Super Wide Angle (SWA), and Ultra Wide Angle (UWA) Eyepieces in the standard American-size (1.25") barrel diameter permit a wide range of magnifying powers with the telescope. Powers obtained with each eyepiece are as follows:

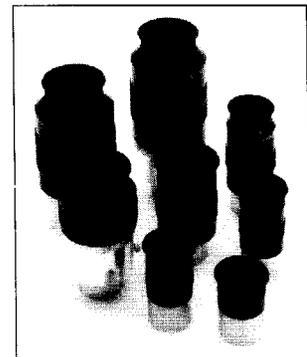

Eyepiece	6" f/8	8" f/6	10" f/4.5	12.5" f/4.8
	Power	Power	Power	Power
SP 6.4mm	191X	191X	178X	238X
SP 9.7mm	126X	126X	118X	157X
SP 12.4mm	98X	98X	92X	123X
SP 15mm	81X	81X	76X	102X
SP 20mm	61X	61X	57X	76X
SP 26mm	47X	47X	44X	59X
SP 32mm	38X	38X	36X	48X
SP 40mm	31X	31X	*	*
SWA 13.8mm	88X	88X	83X	111X
SWA 18mm	68X	68X	63X	85X
SWA 24.5mm	50X	50X	47X	62X
SWA 32mm	38X	38X	36X	48X
SWA 40mm	31X	31X	*	*
UWA 4.7mm	260X**	260X**	243X	324X**
UWA 6.7mm	182X	182X	170X	228X
UWA 8.8mm	139X	139X	130X	173X
UWA 14mm	87X	87X	81X	109X

* Not recommended for 10" and 12.5" models.

** Should be used only under extremely steady atmospheric conditions.

Meade Super Plössl and Super Wide Angle Eyepieces are ideal for general-purpose astronomical or terrestrial observing. The typical Starfinder Dobsonian user may wish to add 2 or 3 of these eyepieces to his or her telescope. An introductory selection might include the SP 9.7mm and SP 15mm. The more advanced observer will perhaps select the SP 9.7mm, SP 12.4mm, and SWA 18mm. The Super Wide Angle Eyepiece series yields extremely wide fields of view, perfect for the examination of star fields, diffuse nebulae, or for terrestrial applications. Under very steady seeing conditions Meade UWA 4.7mm and 6.7mm eyepieces present the widest fields of view obtainable at high powers and are excellent eyepieces for the Moon and planets.

Filters: Thirteen color filters are available for significantly increased contrast and resolution of detail on the Moon and planets. For example, the #80A (blue) filter effectively enhances the reddish-colored detail on the surface of Jupiter. These filters thread into the barrels of all standard 1.25" O.D. eyepieces and may also be used for eyepiece projection photography.

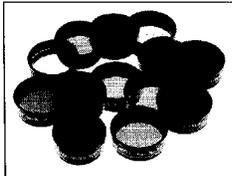

Illuminated Reticle Eyepiece: Permits easy visibility of guiding crosslines even against the darkest skies. The standard #702A double-crossline, phosphorescent-enhanced reticle allows for variable illumination from faint to very bright.

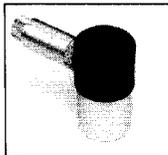

Magellan I: The Magellan I accessory will permit you to add a powerful pointing tool to your Starfinder Dobsonian telescope. Encoders supplied with this product for the R.A. and Dec. axis can be easily installed in factory machined mounting features. Once installed, the Magellan I will allow the electronic selection and pointing of the telescope at a large number of catalogued objects in the sky.

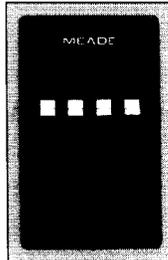

#140 2x Barlow Lens: The Barlow Lens, or Telenegative Amplifier, is a convenient accessory used to increase the effective magnification of any given eyepiece. The Barlow Lens is inserted into the focuser and accepts all standard 1.25" O.D. eyepieces.

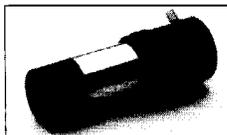

Viewfinders: In addition to the standard-equipment 5x24mm viewfinder supplied with all Starfinder telescopes, the higher power/larger aperture 6x30 and 8x50mm viewfinder are available to substitute or retrofit.

MEADE CUSTOMER SERVICE

If you have a question concerning your Meade Starfinder Dobsonian telescope, call Meade Instruments/Customer Service Department at (949) 451-1450, or fax at (949) 451-1460. Customer Service hours are 8:30AM - 4:00PM, Pacific Time, Monday through Friday. In the unlikely event that your Dobsonian telescope requires factory servicing or repairs, write or call the Meade Customer Service Department first, before returning the telescope to the factory, giving full particulars as to the nature of the problem, as well as your name, address, and daytime telephone number. The great majority of Starfinder servicing issues can be resolved by telephone, avoiding return of the telescope to the factory.

Specifications and Features: Meade Starfinder™ Dobsonian Telescopes

TELESCOPE:	Starfinder Dobsonian 6	Starfinder Dobsonian 8	Starfinder Dobsonian 10	Starfinder Dobsonian 12.5
Optical Design	Newtonian Reflector	Newtonian Reflector	Newtonian Reflector	Newtonian Reflector
Diameter/Clear Aperture	152mm (6")	203mm (8")	254mm (10")	318mm (12.5")
Primary & Secondary Mirrors	Grade-A Pyrex® glass, fine annealed	Grade-A Pyrex® glass, fine annealed	Grade-A Pyrex® glass, fine annealed	Grade-A Pyrex® glass, fine annealed
Secondary Mirror Support	4-vane; steel	4-vane; steel	4-vane; steel	4-vane; steel
Focal Length	1220mm	1220mm	1140mm	1525mm
Focal Ratio	f/8	f/6	f/4.5	f/4.8
Resolving Power (arc secs.)	0.74	0.56	0.45	0.36
Limiting Visual Magnitude	13.5	14.0	14.5	15.0
Limiting Photographic Magnitude	16.0	16.5	17.0	17.4
Image Scale	1.18°/inch	1.18°/inch	1.26°/inch	0.95°/inch
Maximum Practical Visual Power	400X	500X	600X	600X
35mm Angular Film Coverage	1.11° x 1.58°	1.11° x 1.58°	1.19° x 1.70°	0.89° x 1.27°
Optical Tube	7.6" dia. x 48" long-spiral-wound Sonotube	9.6" dia. x 48" long-spiral-wound Sonotube	12.7" dia. x 45" long-spiral-wound Sonotube	15.1" x 58" long-spiral-wound Sonotube
Secondary Mirror Minor Axis	1.18"	1.83"	2.37"	2.60"
Secondary Mirror Obstruction	3.9%	3.6%	5.6%	4.3%
Dobsonian Mounting				
Base Diameter	13.75"	17.1"	22.2"	26.75"
Mount Dimensions (approx.)	12" square x 19" high	16" square x 17" high	21" square x 20" high	25" square x 22" high
Materials	-----All models: thermally-fused Melamine® with industrial particle board core.-----			
Bearings: Altitude	Nylon	Nylon	Nylon	Nylon
Azimuth	Teflon	Teflon	Teflon	Teflon
Net Weights: Optical Tube	20 lbs.	26 lbs.	30 lbs.	55 lbs.
Mounting	14 lbs.	18 lbs.	32 lbs.	41 lbs.
Shipping Weight (approx.)	38 lbs.	49 lbs.	68 lbs.	106 lbs.



MEADE LIMITED WARRANTY

Every Meade telescope, spotting scope, and telescope accessory is warranted by Meade Instruments Corporation ("Meade") to be free of defects in materials and workmanship for a period of ONE YEAR from the date of original purchase in the U.S.A. and Canada. Meade will repair or replace a product, or part thereof, found by Meade to be defective, provided the defective part is returned to Meade, freight-prepaid, with proof of purchase. This warranty applies to the original purchaser only and is non-transferable. Meade products purchased outside North America are not included in this warranty, but are covered under separate warranties issued by Meade international distributors.

RGA Number Required: Prior to the return of any product or part, a Return Goods Authorization (RGA) number **must** be obtained from Meade by writing, or by calling (949) 451-1450. Each returned part or product must include a written statement detailing the nature of the claimed defect, as well as the owner's name, address, and phone number.

This warranty is not valid in cases where the product has been abused or mishandled, where unauthorized repairs have been attempted or performed, or where depreciation of the product is due to normal wear-and-tear. Meade specifically disclaims special, indirect, or consequential damages or lost profit which may result from a breach of this warranty. Any implied warranties which can not be disclaimed are hereby limited to a term of one year from the date of original retail purchase.

This warranty gives you specific rights. You may have other rights which vary from state to state.

Meade reserves the right to change product specifications or to discontinue products without notice.

This warranty supersedes all previous Meade product warranties.





ADVANCED PRODUCTS DIVISION

Meade Instruments Corporation

World's Leading Manufacturer of Astronomical Telescopes for the Serious Amateur

6001 Oak Canyon, Irvine, California 92618 ■ (949) 451-1450

FAX: (949) 451-1460 ■ www.meade.com

© 2000