



SmartStar[®]-G Series Mount and Telescopes

(For 8800, 8802, 8803 and 8804)

Instruction Manual

Table of Content

Table of Content.....	2
1. SmarStar®-G Series Overview	4
1.1. SmartStar®-G Series Features.....	4
1.2. Assembly Terms	6
2. Telescope Assembly	7
3. GOTO NOVA™ 8402G Hand Controller	10
3.1. Key Description.....	10
3.2. The LCD Screen.....	11
4. Getting Started	12
4.1. Level and Align the Mount	12
4.1.1. Level the Mount.....	12
4.1.2. Initial Positions	12
4.2. Setting Up the Mount	12
4.2.1. Set Up Time and Site	12
4.2.2. Using your telescope.....	14
4.2.3. Go to the Moon	14
4.2.4. Initial Star Alignment	14
4.3. Turn Off the Mount.....	15
5. Use SmartStar®-G Telescopes.....	15
5.1. Manual Operation of a Telescope.....	15
5.2. Slew to an Object.....	15
5.2.1. Planets, Sun, Moon	15
5.2.2. Deep Sky Objects	15
5.2.3. Comets.....	16
5.2.4. Asteroids	16
5.2.5. Stars.....	16
5.2.6. User Objects	16
5.2.7. Enter Position.....	16
5.2.8. Watch List	16
5.2.9. Watch List Auto	16
5.3. Land Objects.....	16
5.4. Sync to Target	17
5.5. Electric Focuser	18
5.6. Set Up Controller	18
5.6.1. Set Up Time and Site	18
5.6.2. Set Display Info	18
5.6.3. Set Key Beep	18
5.6.4. Reset All.....	18
5.6.5. Update Firmware.....	18
5.7. Align.....	18
5.7.1. Easy One Star Align	18
5.7.2. One Star Align.....	19
5.7.3. Two Star Alignment.....	19
5.8. User Object List	19
5.8.1. R.A. and DEC.....	19

5.8.2. Comets.....	20
5.8.3. Asteroids.....	21
5.9. Watch List.....	21
5.10. Set Telescope Coord.....	22
5.11. Park Scope.....	22
6. Maintenance and Servicing.....	22
6.1. Maintenance.....	22
6.2. Storage and Transport.....	22
6.3. Troubleshooting.....	23
6.4. iOptron Customer Service.....	24
Appendix A. Technical Specifications.....	25
Appendix B. GOTONOVA™ 8402G HC MENU STRUCTURE.....	26
Appendix C. GOTONOVA™ Star List.....	28
Appendix D. Set Up USB-PC Connection.....	34
Appendix E. Firmware Upgrade.....	38
Appendix F. Use a PC to Control an iOptron Mount.....	41
IOPTRON ONE YEAR LIMITED WARRANTY.....	42



WARNING!

NEVER USE A TELESCOPE TO LOOK AT THE SUN!
Looking at or near the Sun will cause instant and irreversible damage to your eye.
Children should always have adult supervision while observing.

1. SmarStar[®]-G Series Overview

1.1. SmartStar[®]-G Series Features

Alt-Azimuth Mount– The Cube™

The SmartStar[®]-G series come with our patented Alt-Azimuth (AltAzi) mount, *a.k.a.* The Cube™. This compact mount design is probably the most functional and flexible unit on the market. It was named “Hot Product 2008” by Sky and Telescope. Both axis motors are built into a small single unit with optical encoders which provides accurate GOTO and tracking. The mount is universally compatible with all telescopes using a dove-tail connection. In addition, there are no “dead spots” – so you can point your telescope to ANYWHERE above the horizon, whereas, other mounts block the telescope tube at certain points of rotation. This mount also comes standard with AC connection. An optional DC adaptor is available so you can plug your telescope mount into your car if you’re camping or at any remote location.

32-Channel GPS Module

All G-series telescopes come standard with a 32-channel GPS module for fully automated operation. Simply turn on the GOTONOVA™ Hand Controller and the GPS module will automatically synchronize your telescope location and time with the GOTONOVA™ computerized control system. View celestial objects without having to manually punch in the date, time, latitude or longitude.

GOTONOVA™ Computerized Control System

The revolutionary GOTONOVA™ computerized control system is by far the

most technologically advanced automated tracking system available on the market today. With a database over 50,000 celestial objects, including all of the most famous galaxies, nebulae, star clusters, not to mention the planets, you’ll be able to enjoy star gazing with the simple push of a button.

The easy to understand controller on the market

The GOTONOVA™ hand controller is much easier to use than other similar products. The hand controller is more intuitive with menu categories better organized. It also has a larger LCD screen with more lines of content compared with the competition. Using the easy-to-use hand controller and its large LCD screen, you can easily set up your telescope and select where you want to go.

More precise speed control for viewing objects

The control system also allows you to slew the telescope at 5 different drive speeds, keeping the object within the telescope’s viewfinder for as long as you wish.

Compatible with many OTAs

Most Optical Tube Assemblies (OTAs) with dovetail connection should be compatible with the SmartStar[®]-G GOTO AltAzi mount. The payload of a SmartStar[®]-G mount is between 7 to 11 lbs, depending on OTAs and observing condition. (If you do not have a dovetail connection -- attach your OTA using mounting rings and dovetail available at your local telescope store or the OTA manufacturer). Contact iOptron for expert’s advice on compatibility issues.

USB Port

The 8402 hand controller comes with a USB port that tremendously expands the functionalities of the already powerful system. With the USB2COM driver installed, the USB port works as an RS232 serial port. It supports firmware upgrades and computer

control. With ASCOM protocol, you can control your telescope with most ASCOM compatible software. This enables you to utilize the CPU, large screen, and disk space of your PC/laptop. With a wide selection of software, your star gazing experience will never be the same again.

Package Contents¹

- (1) SmartStar[®]-G Mount with built-in GPS receiver (*Models 8800, 8802, 8803 and 8804*)
- (1) GOTONOVA[™] Hand Controller (Part No. 8402G)
- (1) Controller Cable
- (1) USB Cable
- (1) Tripod
- (1) Tripod bolt and Tray Lock
- (1) Tripod Tray
- (1) AC adapter with cord

For Model 8802 (SmartStar[®]-G-R80)

- (1) 80mm Refractor Telescope
- (2) Eyepieces (PL 10mm & PL 25mm)
- (1) 3X Barlow Lens
- (1) 45° Diagonal

For Model 8803 (SmartStar[®]-G-N114)

- (1) 114mm Newtonian Reflector Telescope
- (2) Eyepieces (PL 10mm & PL 25mm)
- (1) Red Dot Finderscope

For Model 8804 (SmartStar[®]-G-MC90)

- (1) 90mm Maksutov-Cassegrain Reflector Telescope
- (2) Eyepieces (PL 10mm & PL 25mm)
- (1) Red Dot Finderscope
- (1) 45° Diagonal

¹ The contents may vary from batch to batch.

1.2. Assembly Terms

1. Telescope tube
2. Dovetail lock
3. Hand controller
4. Altitude lock
5. Mount
6. Tripod
7. Tripod bolt
8. Tray
9. Tray lock

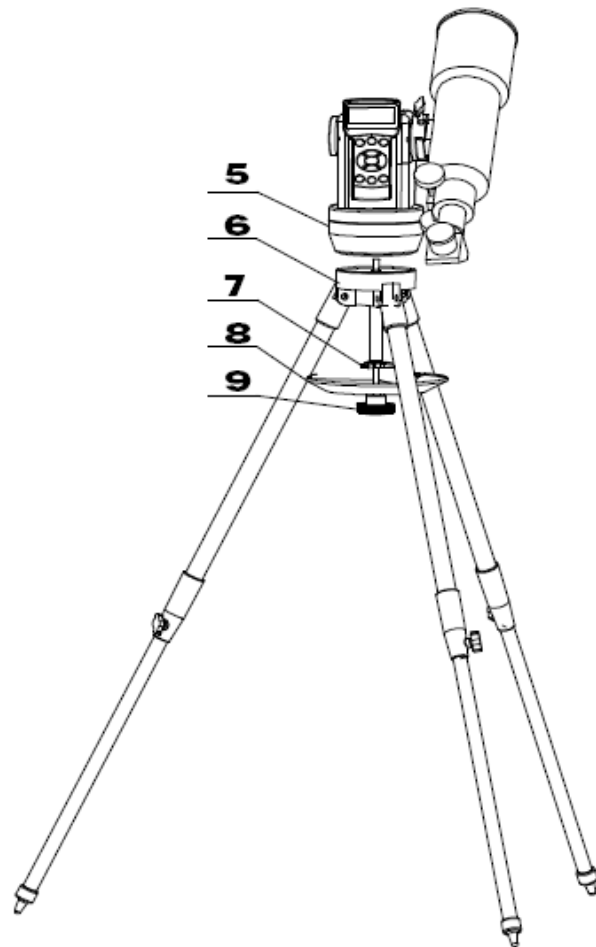
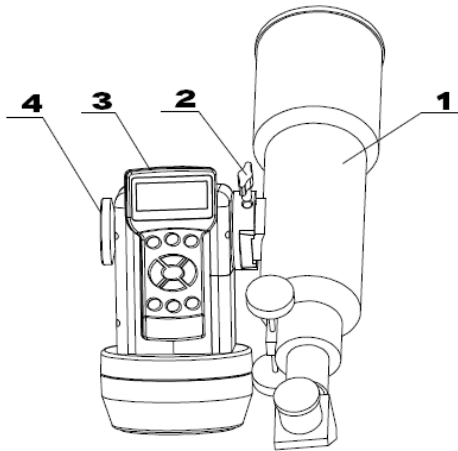

2. Telescope Assembly

	<p>Step 1. Preparing the Tripod Extend tripod legs to full extension.</p>
	<p>Step 2. Attaching the Mount Attach mount to tripod using the long bolt (#7). Slide tray on bottom of shaft. Then screw on round black knob (#9).</p>
	<p>Step 3a. Installing Batteries (not included) Note: you may use 8 AA batteries (Step 3) or the AC adaptor (Step 5) to operate the mount.</p> <p>Pull the batteries compartment cover (shown) open. Gently pull the batteries holder (shown next) out of the compartment to avoid breaking the attached wires.</p>
	<p>Step 3b. Insert 8 AA batteries (not included) according to the diagrams on the holder. Refer to the diagram on the holder to orient the batteries properly. Replace the holder back into the batteries compartment and replace the cover.</p> <p>For reference: the battery pack fits in with wires on the bottom right (See arrow in photo). Use only fresh batteries. Using/mixing old or low batteries may cause error messages.</p> <p>Optional AC Adapter and Car Charger accessories are available at www.ioptron.com</p>
	<p>Step 4. Attaching Telescope Attach telescope to mount using the dovetail lock knob (#2). (Picture shows 80mm refractor. However all scopes will attach in the same manner.)</p>



Step 5. Plug in hand controller and AC adaptor.
 Plug hand controller into either one of the two HBX ports on the mount. Next plug in AC adaptor. (Or use batteries—see step 3). Turn on power (the red light should go on).
 At this point you can begin observing manually. Use the 4 Arrow keys (▲▼◀▶) to rotate the scope Up, Down, Left, and Right. Use the SPEED key to change the slew rate from the slowest (2X) to the fastest (MAX).
 The other HBX is reserved for accessories, such as external GPS module, electronic focuser or laser pointer. **DO NOT plug non-iOptron accessories into the unit to avoid damaging the mount or accessories.**

For 80mm Refractor (#8502)

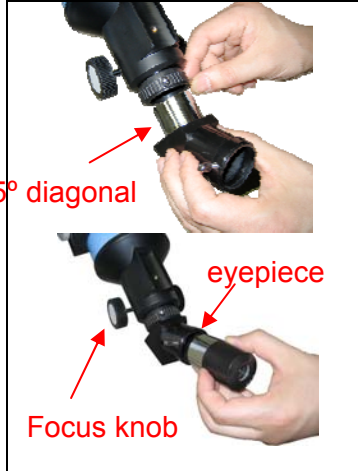

Insert 45° diagonal: Insert the diagonal into the eyepiece side of the telescope. Tighten the thumbscrews to a firm feel only.
Insert the eyepiece: Slide the eyepiece into the open end of the diagonal. Tighten the thumbscrews to a firm feel only. Remove the dust cover from the other end of optical tube assembly.
Use the focus knob to bring objects into focus. You may need to turn the focus knob quite a few turns to focus your telescope for the first time. Always start observing using a low power eyepiece (such as a 25mm eyepiece) to get a nice wide field of view. Later you can change to high power if so desired. Higher powered eyepieces have a much narrower field of view. So it's more difficult to initially locate objects using higher powered eyepieces.

For 114mm Newtonian (#8503)

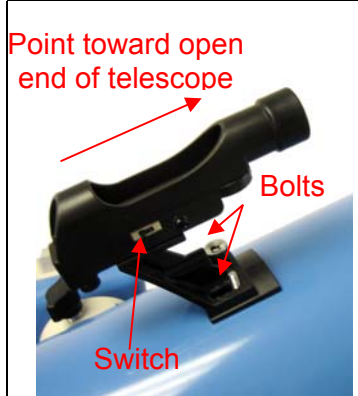



Attach the red dot finder scope to the telescope tube (#1):
 First remove the two washers on the tube. Then place the finder scope onto the two bolts and re-attach the washers securely. The finder scope should face towards the open end of the tube (see arrow in diagram).
 Turn on the beam using the switch on the side. (note: you may need to remove the plastic insulation placed next to the battery underneath)

For 90mm Maksutov-Cassegrain (#8504)

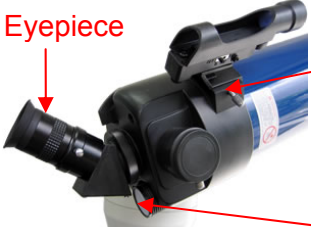

Install **Diagonal** by screwing it onto the back end of the scope. You can adjust the position of the diagonal by loosening the free-spinning threader on the diagonal.

 <p data-bbox="217 184 342 218">Eyepiece</p>	<p data-bbox="561 176 1344 239">Install the Finderscope by sliding the dovetail plate onto the sleeve (see arrow) and tightening the side screw.</p> <p data-bbox="561 275 1382 338">The eyepiece can be placed on the end of the scope or on the side (see next step). Secure the eyepiece using the side screw.</p> <p data-bbox="561 373 1081 407">Use the focus knob to adjust the focus.</p>
 <p data-bbox="82 426 168 489">Flip switch</p>	<p data-bbox="561 445 1409 548">This picture shows the eyepiece on the side. Remove the protective cap to insert the eyepiece. The diagonal is not used for side viewing.</p> <p data-bbox="561 583 1406 646">Use the flip switch to flip the internal mirror to view from the side or the end of the scope.</p>

3. GOTONOVA™ 8402G Hand Controller



Figure 1. GOTONOVA 8402 Hand Controller

GOTONOVA™ 8402G hand controller (HC) is the standard controller for a SmartStar®-G series mount and telescope, as shown in Figure 1.

3.1. Key Description

- MENU: Press “MENU” to enter the Main Menu.
- BACK: Move back to the previous screen, or end/cancel current operation, such as slewing.
- ENTER: Confirm an input, go to the next menu, select a choice, slew the telescope to a selected object, or stop/start tracking.
- Arrow (▲▼▶◀): Press ▲▼ buttons to move a telescope along the altitude direction, ▶◀ to move a telescope along the azimuth direction. Brows the menu or move the cursor in operating menu.
- SPEED Key: To select slew speed (2X, 8X, 64X, 256X, and MAX)
- Light Key(☀): Turns on/off the red LED reading light on the back of the controller.
- HELP Key: Display the definition of some terms.
- HBX (handbox) port: connect the HC to SmartStar mount using a 6-wire RJ11 cable.
- USB port: connect the HC to a Computer via a USB cable.

3.2. The LCD Screen

The 8402 HC consists of a large 4-line LCD screen, which displays all the information as shown in Figure 2. The user interface is simple and easy to learn.

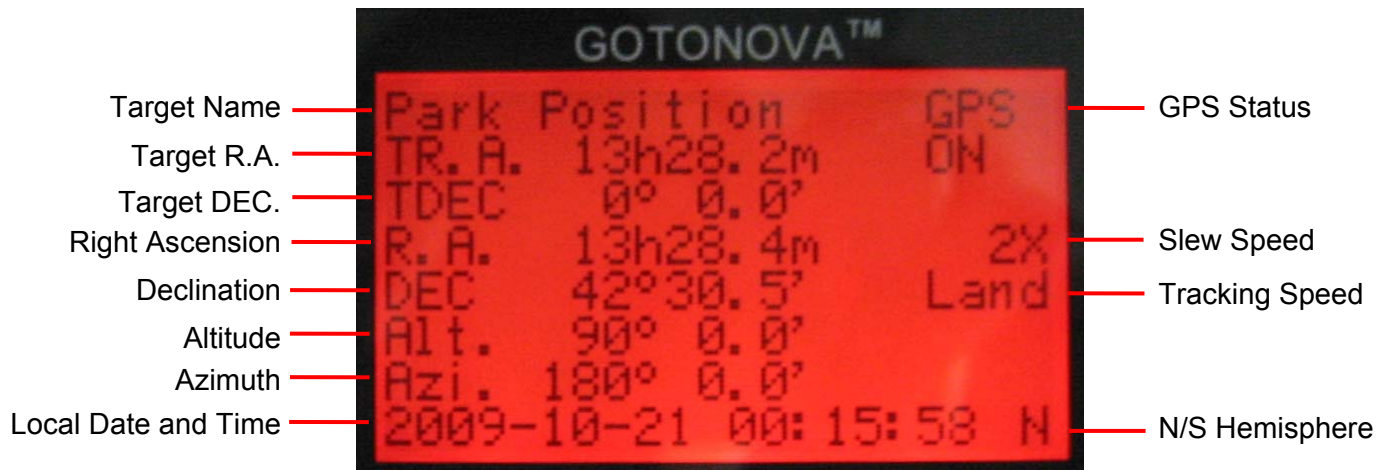

Figure 2. 8402G HC LCD Information Screen

1. Target Name: display the name of the target that telescope is currently point to.
 - Park Position: A default position when the mount is turned on, *i.e.*, the telescope is point to zenith (altitude is 90°) and the mount is facing south (azimuth is 180°);
 - An object name, such as “Mercury” or “Andromeda Galaxy”: Name of the celestial object or land target that is currently slewing, gotoing, observing or tracking;
2. GPS Status: when the power is turned on, it shows “GPS ON”, which means a GPS receiver is connected. When the GPS receiver finds the satellite and receives GPS signal, it shows “GPS OK”. The “GPS OK” may turn off after few minutes.
3. Slew speed: It has 5 speeds: 2X, 8X, 64X, 256X(1°/sec), MAX(4°/sec). Press SPEED key to change it.
4. Tracking speed: display current operation mode of the mount
 - Land: the mount is operating at a land mode.
 - Cel., Sol. or Lun.: the mount is tracking an celestial object at Sidereal, Solar or Lunar speed.
5. Altitude of the telescope (zenith is 90°).
6. Azimuth of the telescope (north is 0°, east 90°, south 180°, and west 270°).
7. Local Date and Time: display local time in a format of YYYY-MM-DD HH:MM:SS.
8. N/S Hemisphere: display the observation hemisphere.

4. Getting Started

In order to experience the full GOTO capability of GOTO NOVA technology, it is very important to set up the mount correctly before observation.

4.1. Level and Align the Mount

4.1.1. Level the Mount.

Leveling is critical for a good GOTO and tracking accuracy.

Level the mount by observing the bubble (shown) on the base of the mount by adjusting tripod legs. The bubble should be in the center of the circle. It is also recommended to use additional levelers (such as a torpedo leveler) to assure precise leveling. Turn the mount around by pressing ► or ◀ button to make sure it is always leveled.

4.1.2. Initial Positions

Each time the mount is turned on, the default position is Park Position, *i.e.*, its altitude is 90°0.0' and azimuth is 180°0.0', which means the "SOUTH" mark is pointing to south and the telescope is pointing straight up at the zenith. To set the Park Position, you can do one of the following:

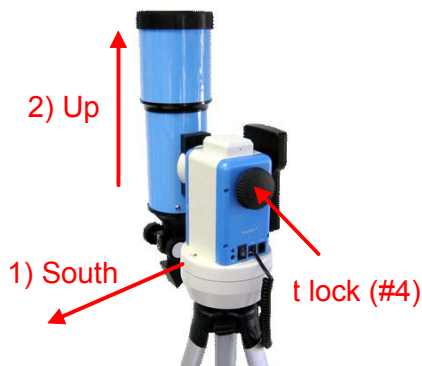

1. Align the mount to south by turning the mount so that the South mark facing south. An additional compass is needed. Unlock the altitude lock (#4) and rotate the telescope to point straight up at the Zenith. A torpedo level may help. Make

sure the mount is leveled. Then turn the mount power on.

or

2. Turn the mount power on. Press the SPEED button to select a slew speed (MAX for fast slew and 2X for fine tuning). Turn the SOUTH mark pointing to south using ► or ◀ button. An additional compass may be needed. Rotate the telescope point to the zenith using ▲ or ▼ button. A torpedo level may help. Then turn the mount power off and turn it on. Or you can press MENU, scroll down to "Set Telescope Coord.", press ENTER. The default number is "Alt: 90°00.0'" and "Azi: 180°00.0'". Press ENTER to complete the initialization.

4.2. Setting Up the Mount

A SmartStar-G is equipped with a GPS receiver, which will receive the local time, longitude and latitude information from

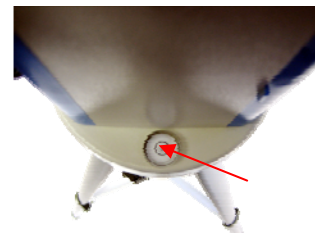

a satellite after the link is established. However, manual input is still needed for time zone and Daylight Saving setting.

A clear sky outside is needed for GPS to communicate well with the satellites.

4.2.1. Set Up Time and Site

Press MENU button, from the main menu, scroll down and select "Set up controller"

```
Select and slew
Land Objects
Sync. to target
Electronic focuser
Set up controller
Align
User Object List
Watch List
```

Press ENTER. Select “Set Up Time and Site”

```

Set Up Time and Site
Set Display Info
Set Key Beep
Reset All
Upgrade Firmware
    
```

Press ENTER. The “Set Local Time” screen will show:

```

Set Local Time:

2009-06-01 11:55:09
300 Min. behind UT
Daylight Time Saving √
    
```

The local time will be updated when the GPS picks up satellite signals. If for any reason your GPS can't pick up a signal you can manually enter the time. Press ◀ or ▶ key to move the cursor and using ▲ or ▼ key to change the number.

Press ◀ or ▶ key, move the cursor to the line below time info to set the time zone information (add or subtract 60 minutes per time zone). Enter minutes “ahead of” or “behind” UT (universal time).

- New York City is 300 minutes “behind” UT
- Los Angeles is 480 minutes “behind” UT
- Rome is 60 minutes “ahead of” UT
- Beijing is 480 minutes “ahead of” UT
- Sydney is 600 minutes “ahead of” UT

All the time zones in North America are *behind* UT (universal time), as shown in the following table. So make sure it shows “behind” instead of “ahead of” UT.

Time Zone	Hours behind UT	Enter Minutes
Hawaii	-10	600
Alaska	-9	540
Pacific	-8	480
Mountain	-7	420
Central	-6	360
Eastern	-5	300

To adjust minutes, move the cursor to each digit and use the n▲ or ▼ key to change the number. To change the “behind” or “ahead of” UT, move the cursor to “ahead of” and using ▲ or ▼ key to toggle between “behind” and “ahead of”. For other parts of the world, you can find out your “time zone” information from internet, such as <http://www.timeanddate.com/worldclock/>.

DO NOT COUNT DAYLIGHT SAVING TIME.

To set daylight saving time, use the ◀ or ▶ key to move the cursor to the bottom of the screen, use ▲ or ▼ button to toggle the Daylight Time Saving between X, which means “No” and √, which means (Yes).

When the number is correct, press ENTER and go to “Setup Site Info” screen:

```

Set up site info:
Longitude:
    W071d27m47s
Latitude:
    N42d15m40s
    
```

The longitude and latitude coordinates will be updated when the GPS picks up satellite signals. “W/E” means west/east hemisphere; “N/S” means north/south hemisphere; “d” means degree; “m” means minute; and “s” means second.

If for any reason your GPS can't pick up a signal you can manually enter the GPS coordinates. Press ◀ or ▶ key to move the cursor and using ▲ or ▼ key to toggle between "W" and "E", "N" and "S", or to change the numbers. It is always a good idea to do your home work to get the GPS coordinates before traveling to a new observation site.

The site coordinates information can be found from internet, such as GPSVisualizer (<http://www.gpsvisualizer.com/geocode>), by entering the city name or address. In case you only find the site information in decimal format you can convert them into d:m:s format by multiplying the decimal numbers by 60. For example, N47.53 can be changed to N47°31'48": $47.53^\circ = 47^\circ + 0.53^\circ$, $0.53^\circ = 0.53 \times 60' = 31.8'$, $0.8' = 0.8 \times 60'' = 48''$. Therefore, $47.53^\circ = 47^\circ 31' 48''$ or 47d31m48s. Same as N47°31.8': $31.8' = 31' + 0.8'$, $0.8' = 0.8 \times 60'' = 48''$.

4.2.2. Using your telescope

Selecting an Eyepiece:

1. Always begin viewing with the lowest power eyepiece. (Note: a 25 mm focal length eyepiece has a lower power than a 10 mm one.) A formula can be used to determine the power of each eyepiece: Telescope focal length divided by eyepiece focal length equals magnification. Ex. $400\text{mm} \div 25\text{mm} = 16\text{X}$ (magnification). The rule of thumb is that the magnification should not be too much larger than the OTA aperture, otherwise view and color distortion may occur.

2. A 45° Erecting Diagonal Prism is included in the R80 or MC90 telescope. The Erecting Diagonal Prism is used to erect the image you will see. Astronomical telescopes are designed in such a way that the image you see may be UPSIDE DOWN and REVERSED. This is perfect for viewing celestial bodies. However, it will feel strange when observing a land object or a bird.

Focusing Telescope:

1. After selecting the desired eyepiece aim the telescope tube at a land-based target at least 200 yards away (e.g. A telephone pole or building). Fully extend focusing tube by turning the focus knob.
2. While looking through selected eyepiece, slowly retract focusing tube by turning focusing knob until object comes into focus.

Aligning Finderscope:

1. Look through main telescope tube and establish a well-defined target (see focusing telescope section). Tighten all lock knobs (Declination, Latitude, Right Ascension, Horizontal Axis) so that telescope's aim is not disturbed.
2. Turn on the red dot finder and look through the finder window. Adjust the red dot alignment screws to center the red dot on the object.
3. Now, objects located with the finderscope first will be centered in field of view of the main telescope.

4.2.3. Go to the Moon

After performing these setups, the mount is ready to GOTO and track objects. The most common object will be the Moon.

Press MENU button, select "Select and Slew" by press ENTER button. Select "Planets, Sun, Moon", and using ▲ or ▼ button to select Moon. Press ENTER. The telescope will automatically slew to the Moon and lock on. It will automatically begin to track once it locks on to it. Use the arrow keys to center the Moon in your eyepiece, if it is not centered. Press BACK key to stop GOTO during the slew. Press ENTER key to stop the tracking.

4.2.4. Initial Star Alignment

A simple alignment/synchronization can be performed to improve the GOTO and

tracking accuracy. To do so, press MENU button, scroll down to “Align”, select “Easy One Star Align” and press ENTER. A list of three bright objects, such as Moon, Venus, and other stars, will be displayed for you to select from. Select an object using ▲ or ▼ key. Then press ENTER. Use ◀ ▶ ▲ or ▼ key to center the object in your eyepiece. Press SPEED button to change the slew speed if needed. Then press ENTER to complete the alignment. Or press the BACK key to cancel the process.

An alternate way is performing “Sync to Target”. To do so, press MENU button, select “Select and Slew” and press ENTER. Then select a known sky object, such as Moon from “Planets, Sun, Moon” menu and press ENTER. The mount will slew to the Moon. When the mount stopped slewing, the Moon could be just inside your eyepiece or way off. Press MENU button and scroll down the menu to “Sync to Target” and press ENTER. Follow the instruction, use ◀ ▶ ▲ and ▼ keys to move the Moon in the center of your eyepiece and press ENTER.

4.3. Turn Off the Mount

When finishing observing, always move the mount to Park Position. If the mount is not moved, no initial set up is needed when powered on the next time. To do so, press the MENU button, scroll down to “Park Telescope” and press ENTER. Turn the power off.

5. Use SmartStar[®]-G Telescopes

5.1. Manual Operation of a Telescope

You may observe land and astronomical objects using GOTONOVA’s arrow keys.

After the telescope was assembled (referring to Section 2. Telescope Assembly), flip the I/O switch on the

telescope mount to turn on the mount. Use ▶, ◀, ▼ or ▲ buttons to point the telescope to desired object. You may need using SPEED key to change the slewing speed.

5.2. Slew to an Object

Press MENU button, from the main menu, select “Select and Slew.” Select an object you would like to observe and press ENTER key.

The GOTONOVA[™] 8402G hand controller has a database consists of over 50,000 objects. Use ▶ or ◀ button to move the cursor and ▼ or ▲ button to change the number. A check mark “√” indicates the object is above the horizon, and cross mark “X” means it is below the horizon. Only those objects above the horizon can be observed. In some catalogs, those stars below the horizon may not display.

5.2.1. Planets, Sun, Moon

There are 9 objects in Solar system.

5.2.2. Deep Sky Objects

This menu includes objects outside our Solar system such as galaxies, star clusters, quasars, nebulae.

- Named Deepsky Objects: It consists of 60 deep sky objects with their common names. More information will be available by pressing HELP key. A list of named deep sky objects is also attached in Appendix C.
- Messier Catalog: It consists of all 110 objects in Messier catalog. More information will be available by pressing HELP key.
- NGC IC Catalog: consists of 7840 objects in NGC catalog and 5386 objects in IC catalog. To select an object from NGC or IC catalog, move the cursor to NGC, using ▲ or ▼ button to toggle between NGC and IC. Then move the cursor to numerical position

and use the number button to select the object.

- UGC Catalog: consists of 12939 objects.

5.2.3. Comets

It contains up to 64 comets, with 16 pre-loaded comets. This database is customer upgradeable.

5.2.4. Asteroids

It contains up to 64 asteroids, with 16 pre-loaded asteroids. This database is customer upgradeable.

5.2.5. Stars

- Named Stars: It consists of 191 stars with their common names. They are listed alphabetically. A list is attached in Appendix C.
- Constellations: It consists of 88 modern constellations with their names. They are listed alphabetically. A list is attached in Appendix C.
- Double Stars: It consists of 40 double stars. A list is attached in Appendix C.
- SAO Bright Stars: It consists of 21460 SAO catalog objects.

5.2.6. User Objects

It can consist up to 128 user predefined objects. These objects need to be entered before they can be selected for slewing (Refer to 5.8.1 R.A. and DEC).

5.2.7. Enter Position

Go to a target by entering its R.A. and DEC numbers.

5.2.8. Watch List

A watch list is a list of your favorite celestial objects in the database. It can be selected for slewing. User can add, delete and

browse the watch list. (Refer to 5.9 Watch List).

5.2.9. Watch List Auto

This function will set the mount automatically slew to all the objects listed in Watch List at a preset time interval. The time interval can be set to from 10 seconds to 1200 seconds by using ▼ or ▲ button.

5.3. Land Objects

Up to 64 your favorite land objects can be stored in the hand controller. Press MENU, select “Land Objects” and press ENTER, the Land Objects screen will show.

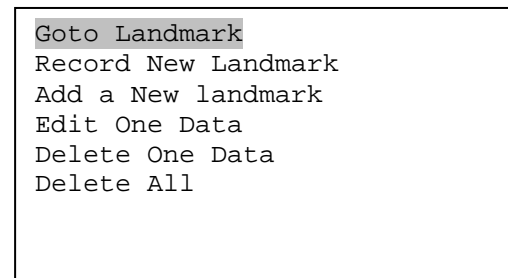

Goto Landmark:

Use ▼ or ▲ button to move the cursor to “Goto Landmark” line, press ENTER. The first saved landmark will display:

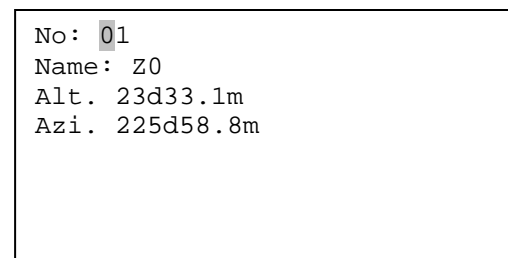

Use ► or ◀ button to move the cursor and ▼ or ▲ button to change the number, then press ENTER. The mount will automatically slew to the target.

This function only works if a land object has been stored in database.

Record New Landmark

Use ▼ or ▲ button to move the cursor to “Record New Landmark” line, and press ENTER. A landmark screen will show:

```
Alt.    13° 0.0'  
Azi.    25°58.8'  
  
Use arrow keys to  
Move. Press "ENTER"  
To modify.                                64X
```

Use ◀ ▶ ▲ and ▼ keys to slew the telescope to the target you want to observe. Press SPEED button to change the slew speed if needed. Then press ENTER to save the target. Enter the Name using ▼ or ▲ to select form A-Z, 0-9 and “-, space”. (such as Z0). The object No. will be assigned by the system in order. Press ENTER to record your landmark.

Add a new Landmark

Use ▼ or ▲ button to move the cursor to “Add a new Landmark” line, and press ENTER. Enter the Name using ▼ or ▲ to select form A-Z, 0-9 and “-, space”. (such as Z0). A coordinate setting screen will show:

```
Enter Alt. Azi.  
Alt: 13d 0.0m  
Azi: 25d58.8m
```

Use ▶ or ◀ button to move the cursor, and ▼ or ▲ button to change the number. Then press ENTER. Press ENTER to add the landmark information.

Edit One Data

Use ▼ or ▲ button to move the cursor to “Edit One Data” line, and press ENTER. The first saved landmark will display:

```
No: 01  
Name: Z0  
Alt. 23°33.1'  
Azi. 225°58.8'
```

Use ▶ or ◀ button to move the cursor and ▼ or ▲ button to change the number, then press ENTER. You can change the name and Alt/Azi coordinates accordingly.

Delete One Data

Use ▼ or ▲ button to move the cursor to “Delete One Data” line, and press ENTER. The first saved landmark will display:

```
No: 01  
Name: Z0  
Alt. 23°33.1'  
Azi. 225°58.8'
```

Use ▶ or ◀ button to move the cursor and ▼ or ▲ button to change the number, then press ENTER. Press ENTER to confirm the deletion.

Delete All Data

Use ▼ or ▲ button to move the cursor to “Delete All Data” line, and press ENTER. Press ENTER to confirm the deletion.

Press BACK to back to main menu.

5.4. Sync to Target

This operation will match the telescope's current coordinates to Target Right Ascension and Declination. After slew to an object, move the cursor to “Sync to Target” and press ENTER. Follow the screen to do the sync. Using this function can improve

the GOTO accuracy in nearby sky. Multiple syncs can be performed if needed.

“Sync to Target” will only work after “Select and slew” was performed. You may need using SPEED key to change the slewing speed to make the centering procedure easier. A default slew speed is 2X.

5.5. Electric Focuser

If you have an electric focuser in your system and it is supported by GOTO NOVA, use this option to adjust the focuser. Use ◀▶ for coarse tuning and ▼▲ for fine tuning.

Refer to your Electric Focuser operation manual for detailed instruction.

5.6. Set Up Controller

5.6.1. Set Up Time and Site

- Please refer to section 4.2.

5.6.2. Set Display Info

- Adjust LCD Contrast

Use arrow keys to adjust LCD display contrast. Press ENTER.

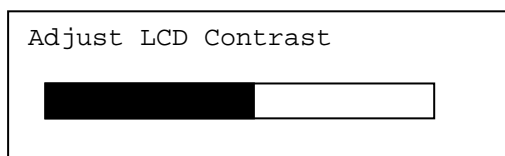

- LCD Back Light.

Use arrow keys to adjust LCD screen back light intensity. Press ENTER.

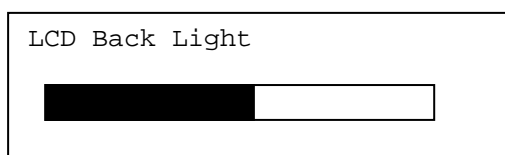

- Keypad Backlight.

Use arrow keys to adjust keypad backlight. Press ENTER.

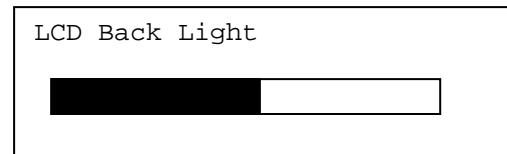

5.6.3. Set Key Beep

Turn the key beep on/off.

5.6.4. Reset All

Reset all settings to factory default data.

5.6.5. Update Firmware

Firmware updating using iOptron Downloader through USB port on hand controller. (Refer to Appendix E.)

5.7. Align

This function is used for align the telescope. Before star alignment, please make sure the mount is well leveled. The system also provides “Easy One Star Align”, “One Star Align” and “Two Star Align”. Any one can be selected for telescope alignment.

5.7.1. Easy One Star Align

From the main menu, select “Align”. Select “Easy One Star Align” and press ENTER. Three most popular objects, such as Moon, a planet or a bright star that are above the horizon will be provided for selection. Use ▲ or ▼ button to select an alignment star and press ENTER. Then manually slew the telescope to the object and center the object in your eyepiece using ◀▶ ▲ or ▼ key. Press SPEED button to adjust the slew speed. Then press ENTER to complete the alignment. Or press the BACK key to cancel the process.

5.7.2. One Star Align

From the main menu, select “Align”. Select “One Star Align” and press ENTER. A list of align stars that are above the horizon is computed based on your local time and location. Use ▲ or ▼ button to select an alignment star and press ENTER. Center the object in your eyepiece using ◀ ▶ ▲ or ▼ key. Press SPEED button to adjust the slew speed. Then press ENTER to complete the alignment. Or press the BACK key to cancel the process.

If you have a very good initial setup, one star alignment should be sufficient for good GOTO accuracy. To increase the accuracy you may choose to do two star alignment.

5.7.3. Two Star Alignment

Two star alignment will increase the GOTO accuracy of the mount. It is suggested to do two star alignment after one star alignment. Select “Two Star Align” in the Align menu. Use ▲ or ▼ button to select a star and press ENTER. The mount will slew to it automatically. Use ◀ ▶ ▲ or ▼ key to center the object in your eyepiece. Press SPEED button to adjust the slew speed if needed. Then press ENTER to complete the alignment. After you finish the first star, the system will prompt you to choose the second star. Repeat the process to finish the second star alignment. An “Align OK!” screen will show briefly. To obtain a better alignment effect, it is suggested to choose two align stars far apart.

“Two Star Align” result will be overridden if “One Star Align” or “Sync. to Target” is performed after “Two Star Align.”

5.8. User Object List

Besides various star lists available in the hand controller, users can add, edit or delete their own defined objects. The comets and asteroids list also can be edited. Up to 128 user objects can be added

or modified. For comets or asteroids, the maximum number is 64, which includes the preloaded objects.

To edit a user object, press MENU, use ▲ or ▼ button move the cursor to “User Object List” and press ENTER. A following screen will show:

```
R.A. and DEC.  
Comets  
Asteroids
```

Use ▲ or ▼ button to select R.A. and DEC., comets or asteroids.

5.8.1. R.A. and DEC.

Select “R.A. and DEC.” and press ENTER, a menu like following will show:

```
Add a new object  
Edit one data  
Delete one data  
Delete all
```

Add a new object:

Use ▼ or ▲ button to move the cursor to “Add a new object” line, and press ENTER. Enter the name of your object by using ▲ or ▼ key to change the display from 1 to 9, space, - and A to Z, and ◀ or ▶ key to move the cursor. Press ENTER when you are done. A screen will display to ask you to enter R.A. and DEC. numbers:

```
Enter R.A. DEC  
RA: 00h00.0m  
DEC: +00d00.0m
```

Use ◀ or ▶ key to move the cursor and ▲ or ▼ key to change the numbers of your object. RA ranges from 0 hour to 24 hour and DEC from -90 degree to +90 degree. Press ENTER when it is done. A confirmation screen will show:

```
Save to No.      003 ?
Press "ENTER" to
Confirm
Press, "BACK" to
Cancel
```

Press ENTER to confirm. The user object will be stored in the hand controller in sequence. Up to 256 objects can be added.

Edit one data

Use ▼ or ▲ button to move the cursor to "Edit one data" line, and press ENTER. A user object screen will show:

```
No: 003
Name: SAO2940
R.A.   17h30.7m
DEC    86°58.1'
```

The first line shows the number of the user object. The second line shows the name of the user object, here is "SAO2940". The next two lines shows target's current RA and DEC coordinates. Use ◀ or ▶ move the cursor position and ▲ or ▼ key change the number and press ENTER to select the object you want to edit.

Follow the same procedure as "Add a new object" to edit it.

Delete one data

Use ▼ or ▲ button to move the cursor to "Delete one data" line, and press ENTER. A user object screen will show:

```
No: 003
Name: SAO2940
R.A.   17h30.7m
DEC    86°58.1'
```

, and ▼ or ▲ button to change the number. Press ENTER to delete selected object.

Delete all

Use ▼ or ▲ button to move the cursor to "Delete all" line, and press ENTER to delete all user R.A. and DEC. data.

5.8.2. Comets

Select "Comets" and press ENTER, a menu like following will show:

```
Add a new comet
Edit one data
Delete one data
Reset comet data
```

Add a new comet:

The hand controller has 16 preloaded comets. Up to 64 comets can be stored in the hand controller.

Select "Add a new comet" and press ENTER. Enter the name of your object by using ▲ or ▼ key to change the display from 1 to 9, space, - and A to Z, and ◀ or ▶ key to move the cursor. It will then ask the following information: Year, Month, Day, e, q, w, Omega and i. After entering all these parameters, a confirmation screen will show:

```

Save to No.      17 ?
Press "ENTER" to
Confirm
Press, "BACK" to
Cancel

```

object

will be stored in next available or previous deleted comet position. It can be selected and slewed from Comets menu.

Edit one data

Use ▼ or ▲ button to move the cursor to "Edit one data" line, and press ENTER. A user object screen will show:

```

No: 17 X
Name: 2P
R.A. 23h 3.5m
DEC 0°34.8'
Alt. -44°44.5'
Azi. 21°56.9'

```

The first line shows the number of this comet and if it is above the horizon. The second line shows the name of the comet, here is "2P". The third line shows comet's current RA and DEC coordinates. The bottom line shows its altitude and azimuth position. Use ◀ or ▶ move the cursor position and ▲ or ▼ key change the number and press ENTER to select the object you want to edit.

Follow the same procedure as "Add a new comet" to edit it.

Delete one data

Use ▼ or ▲ button to move the cursor to "Delete one data" line, and press ENTER. A screen consists comet information will show:

```

No: 17 X
Name: 2P
R.A. 23h 3.5m
DEC 0°34.8'
Alt. -44°44.5'
Azi. 21°56.9'

```

Use ▶ or ◀ button to move the cursor, and ▼ or ▲ button to change the number. Press ENTER to delete selected object.

Reset comet data

Use ▼ or ▲ button to move the cursor to "Reset comet data" line, and press ENTER to restore all deleted or modified comets data to factory default setting.

5.8.3. Asteroids

Select "Asteroids" and press ENTER, a menu like following will show:

```

Add a new Asteroid
Edit one data
Delete one data
Reset Asteroids data

```

Refer to 5.8.2 Comets to set the Asteroids.

5.9. Watch List

A watch list is a list of your favorite celestial objects in the database. User can add, delete and browse the watch list. All celestial objects, include User objects, can be compiled into the list. Up to 20 objects can be added to the watch list.

To setup/modify a Watch List, press MENU, use ▲ or ▼ button move the cursor to "Watch List" and press ENTER. A following screen will show:

Add a watch object
Delete one data
Delete all
Browse the list

Select "Add a watch object" and press ENTER. Browse the celestial object list and select the one you want to watch by press ENTER. Follow the screen prompt to confirm the selection. After you are done, press BACK to back to Watch List menu.

You also can delete one or all objects in your watching list. After the watch list is set, it can be observed through "Select and Slew" operation, either watching them manually or automatically using Watch List Auto.

5.10. Set Telescope Coord.

Set the current Altitude and Azimuth of your telescope.

5.11. Park Scope

Park your telescope. Return the telescope to its initial position, *i.e.*, its altitude is 90°0.0' and azimuth is 180°0.0'.

6. Maintenance and Servicing

6.1. Maintenance

The SmartStar® G mount or telescope is a precision instrument designed to yield a lifetime of rewarding applications. Given the care and respect due any precision instrument, your telescope will rarely require factory servicing or maintenance. Maintenance guidelines include:

1. Using wet cloth to clean the mount and hand controller. Do not use the solvent.
2. Leave the dust cap on while not operating the telescope. Avoid cleaning the telescope's optics. A little dust on

the front surface of the telescope's correcting lens causes virtually no degradation of image quality and should not be considered a reason to clean the lens.

3. When absolutely necessary, dust on the front lens should be removed with gentle strokes of a camel hair brush, a soft glass clean cloth or blown off with an ear syringe (available at any pharmacy). Do not use a commercial photographic lens cleaner.
4. Organic materials (e.g., fingerprints) on the front lens may be removed with a solution of 3 parts distilled water to 1 part isopropyl alcohol. Use soft, white facial tissues or cotton balls and make short, gentle strokes. Change tissues often. Do not use scented, colored, or lotioned tissues as damage could result to the optics.
5. If your telescope is used outdoors on a humid night, telescope surfaces may accumulate water condensation. While such condensation does not normally cause any damage to the telescope, it is recommended that wait the entire telescope be dried before being packed away. Do not wipe any of the optical surfaces. In addition, the dust cap should not be placed back on to the optical tube until the telescope is thoroughly dry.
6. If your telescope is not to be used for an extended period, perhaps for one month or more, it is advisable to remove the batteries from battery holder, if they are installed. Batteries left installed for prolonged periods may leak, causing damage to the telescope's electronic circuitry.
7. Do not leave your telescope outdoors on a warm day or inside a sealed car for an extended period of time. Excessive ambient temperatures can damage the telescope's internal lubrication and electronic circuitry.

6.2. Storage and Transport

When not in use, store the telescope in a cool, dry place. Do not expose the

instrument to excessive heat or moisture. It is best to store the telescope in its original box with the altitude lock knob unlocked. If shipping the telescope, use the original box and packing material to protect the telescope during shipment.

When transporting the telescope, take care not to bump or drop the instrument; this type of abuse can damage the optics or affect the GOTO tracking accuracy.

6.3. Troubleshooting

The following suggestions may be helpful with operation of the SmartStar® E mount or telescope.

The power indicator light on the mount does not come on or there is no response when pressing hand controller's arrow keys:

1. Verify that the power switch on the mount is in the ON position.
2. Verify that the hand controller cord is firmly connected to the HBX port on the mount, or switch the cord to the other HBX port.
3. Check the power source, which include:
 - Using the battery? Are the batteries installed correctly? Are the batteries fresh? How long have they been used? (frequent slew and GOTO will deplete battery power very quickly)
 - Using AC or DC adapter? Check the plugs to the mount and to the power outlet.
 - Using extension cord? Make sure the cord is in good condition. Power drop along the extension cord was known to cause the problem. Also check all the plugs and connections.
1. If the telescope does not respond to commands, set the power switch to OFF and then back to ON.
2. If the telescope does not slew after power is applied or if the motor quits or stalls, verify that there are no physical obstructions that would impede telescope movement.

Cannot seem to focus (No image appears in the eyepiece):

1. Confirm that the dust cap has been removed from the telescope.
2. Keep turning the focus knob. Your telescope has a fine focusing mechanism which allows you to focus an image very precisely. However, this means that you may have to rotate the focus knob 20 to 40 complete turns to achieve focus, particularly the first time you use your telescope. After that, fewer turns will be needed.

Images through the eyepiece appear unfocused or distorted:

1. The magnification used may be too high for the seeing conditions. Back off to a lower power eyepiece.
2. If inside a warm house or building, move outside. Interior air conditions may distort terrestrial (land) or celestial images, making it difficult, if not impossible, to obtain a sharp focus. For optimal viewing, use the telescope outside in the open air instead of observing through an open or closed window or screen.
3. If viewing a land object on a warm day, heat waves distort the image.
4. The optics within the telescope need time to adjust to the outside ambient temperature to provide the sharpest image. To "cool down" the optics, set the telescope outside for 10 to 15 minutes before observing begins.

Error Message "Warning! Motor driver overloaded."

1. Check the hand controller cord. Unplug it and re-plug into, or plug it into another HBX port.
2. Check the power source.

The telescope does not GOTO the right object, or the alignment is always wrong:

1. Leveling (very important).
2. Site information (minutes ahead or behind UT, DST).
3. Check the power source.

6.4. iOptron Customer Service

If you have a question concerning your telescope, contact the iOptron Customer Service Department. Customer Service hours are 9:00 AM to 5:00 PM, Eastern Time, Monday through Friday. In the unlikely event that the telescope requires factory servicing or repairs, write or call the iOptron Customer Service Department first, before returning the telescope to the factory, giving full particulars as to the nature of the problem, as well as your name, address, and daytime telephone number. The great majority of servicing issues can be resolved by telephone, avoiding return of the telescope to the factory.

It is also strongly suggested to send your technical questions to support@ioptron.com

Appendix A. Technical Specifications

SmartStar® GOTO Mount	
Mount	AltAzimuth Mount
Body Materials	Die-cast Aluminum
Motor	Dual-Axis DC Servo motor with encoders
Gear	Acetal worm wheel/Nylon 6 worm gear
Bearing	4 steel ball bearings
Speed	Dual-Axis, 5-Gear, Electronic (2×,8×,64×,256×,MAX)
GOTO System	GOTONOVA™ 8402G
Processor	32bit ARM
Object in Database	50,000+
GOTO accuracy	1 Arc Min. (Typical)
Tracking	Automatic
Payload	7 ~ 11 lb
Battery	AA x 8 (Not Included)
Power Requirement	DC 12V±2V, >1.2A
Operating Temperature	0 ~ 40°C
Weight with tripod	5.5 lbs (without OTA)
Refractor Telescope	
Optical Design	Achromatic Refractor
Clear Aperture	80 mm
Focal Length	400 mm
Focal Ratio	f/5
Resolving Power	1.4 arc secs
Weight	2.2 lbs
Newtonian Reflector Telescope	
Optical Design	Reflector
Clear Aperture	114 mm
Focal Length	1000 mm
Focal Ratio	f/8.8
Resolving Power	1 arc secs
Finderscope	Red dot
Weight	4 lbs
Maksutov-Cassegrain Telescope	
Optical Design	Maksutov-Cassegrain
Clear Aperture	90 mm
Focal Length	1200 mm
Focal Ratio	f/13.3
Resolving Power	1.3 arc secs
Finderscope	Red dot
Weight	4 lbs

Appendix B. GOTO NOVA™ 8402G HC MENU STRUCTURE

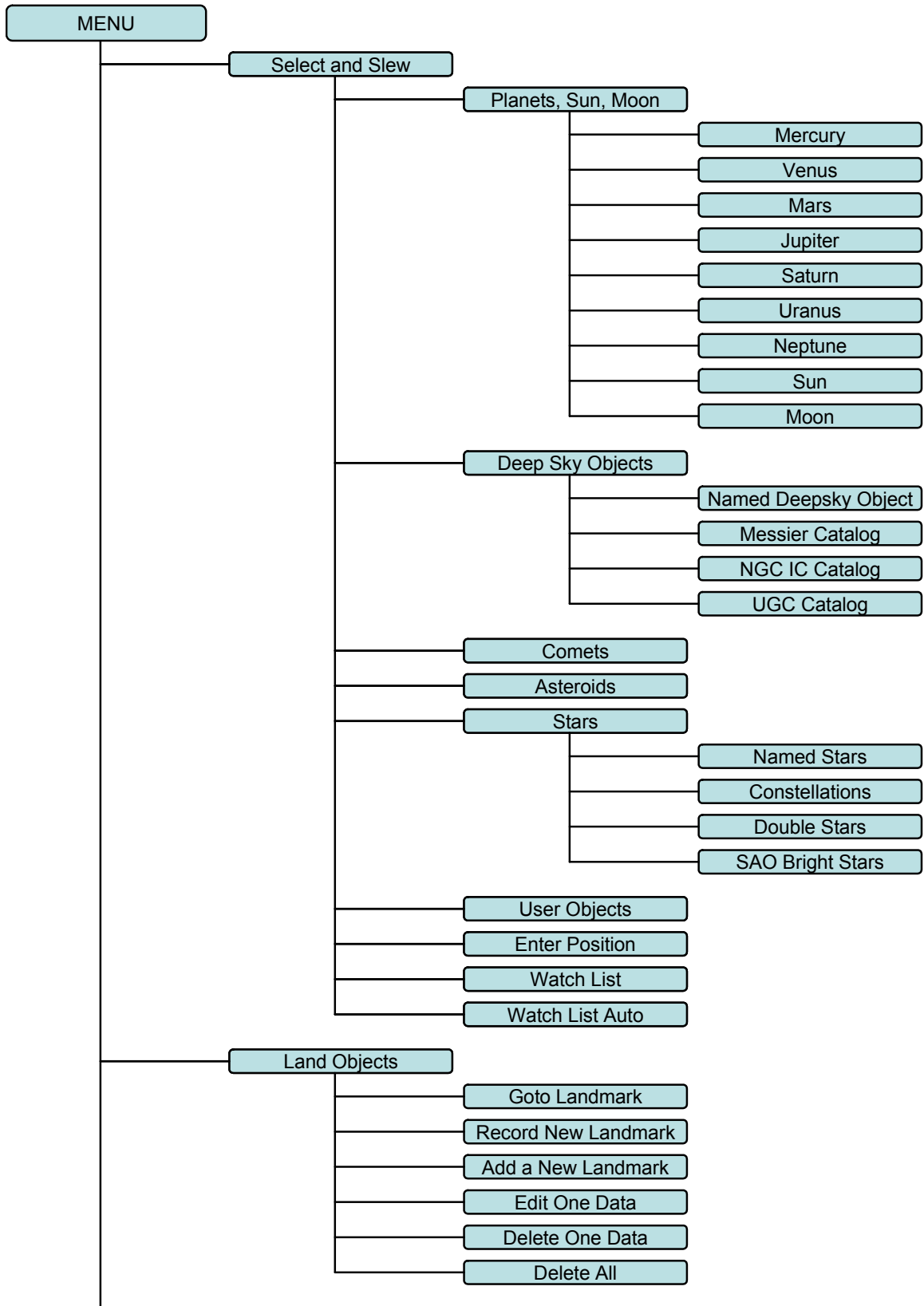

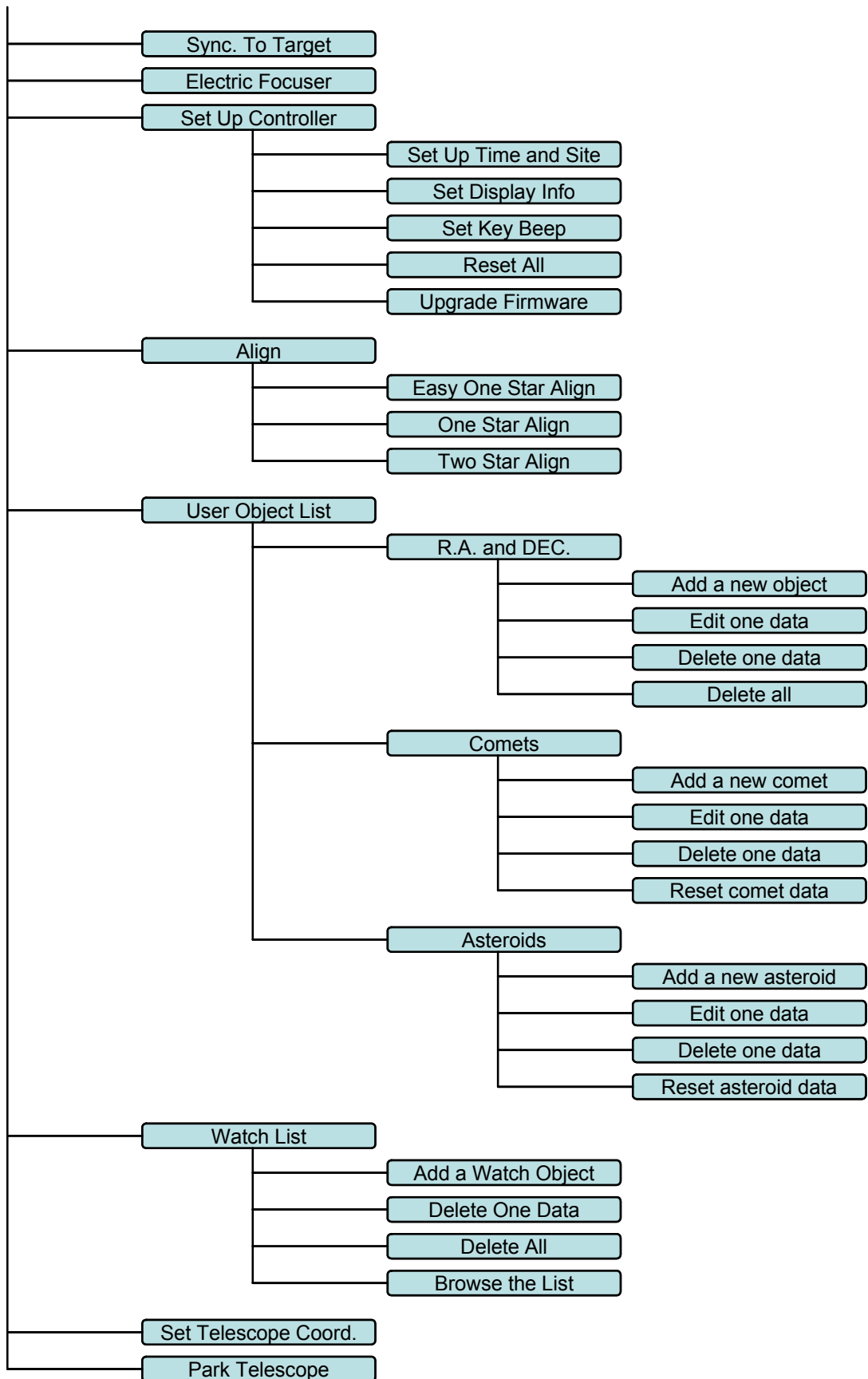

Appendix C. GOTONOVA™ Star List

GOTONOVA Deep Sky Object List for 8402G

ID No.	OBJECT	NGC #	Messier #	IC#	A(Abell)	U(UGC)
1	Andromeda Galaxy	224	31			
2	Barnards Galaxy	6822				
3	Beehive Cluster	2632	44			
4	Blackeye Galaxy	4926	64			
5	Blinking Planetary Nebula	6826				
6	Blue Flash Nebula	6905				
7	Blue Planetary	3918				
8	Blue Snowball Nebula	7662				
9	Box Nebula	6309				
10	Bubble Nebula	7635				
11	Bipolar Nebula	6302				
12	Butterfly Cluster	6405	6			
13	California Nebula	1499				
14	Cat's Eye Nebula	6543				
15	Cocoon Nebula			5146		
16	Cone Nebula	2264				
17	Cork Nebula	650-51	76			
18	Crab Nebula	1952	1			
19	Crescent Nebula	6888				
20	Draco Dwarf					10822
21	Duck Nebula	2359				
22	Dumbbell Nebula	6853	27			
23	Eagle Nebula		16			
24	Eight-Burst Nebula	3132				
25	Eskimo Nebula	2392				
26	Flaming Star Nebula			405		
27	Ghost of Jupiter	3242				
28	Great Cluster	6205	13			
29	Helix Nebula	7293				
30	Hercules Galaxy Cluster				2151	
31	Hind's Variable Nebula	1555				
32	Hubble's Variable Nebula	2261				
33	Integral Sign Galaxy					3697
34	Jewel Box Cluster	4755				
35	Keyhole Nebula	3372				

36	Lagoon Nebula	6523	8			
37	Little Gem	6445				
38	Little Gem Nebula	6818				
39	Little Ghost Nebula	6369				
40	North American Nebula	7000				
41	Omega Nebula	6618	17			
42	Orion Nebula	1976	42			
43	Owl Nebula	3587	97			
44	Pelican Nebula			5070		
45	Phantom Streak Nebula	6741				
46	Pinwheel Galaxy	598	33			
47	Pleiades		45			
48	Ring Nebula	6720	57			
49	Ring Tail Galaxy	4038				
50	Rosette Nebula	2237				
51	Saturn Nebula	7009				
52	Sextans B Dwarf					5373
53	Small Magellanic Cloud	292				
54	Sombrero Galaxy	4594	104			
55	Spindle Galaxy	3115				
56	Tank Track Nebula	2024				
57	Trifid Nebula	6514	20			
58	Ursa Minor Dwarf					9749
59	Whirlpool Galaxy	5194	51			
60	Wild Duck Cluster	6705	11			

Messier

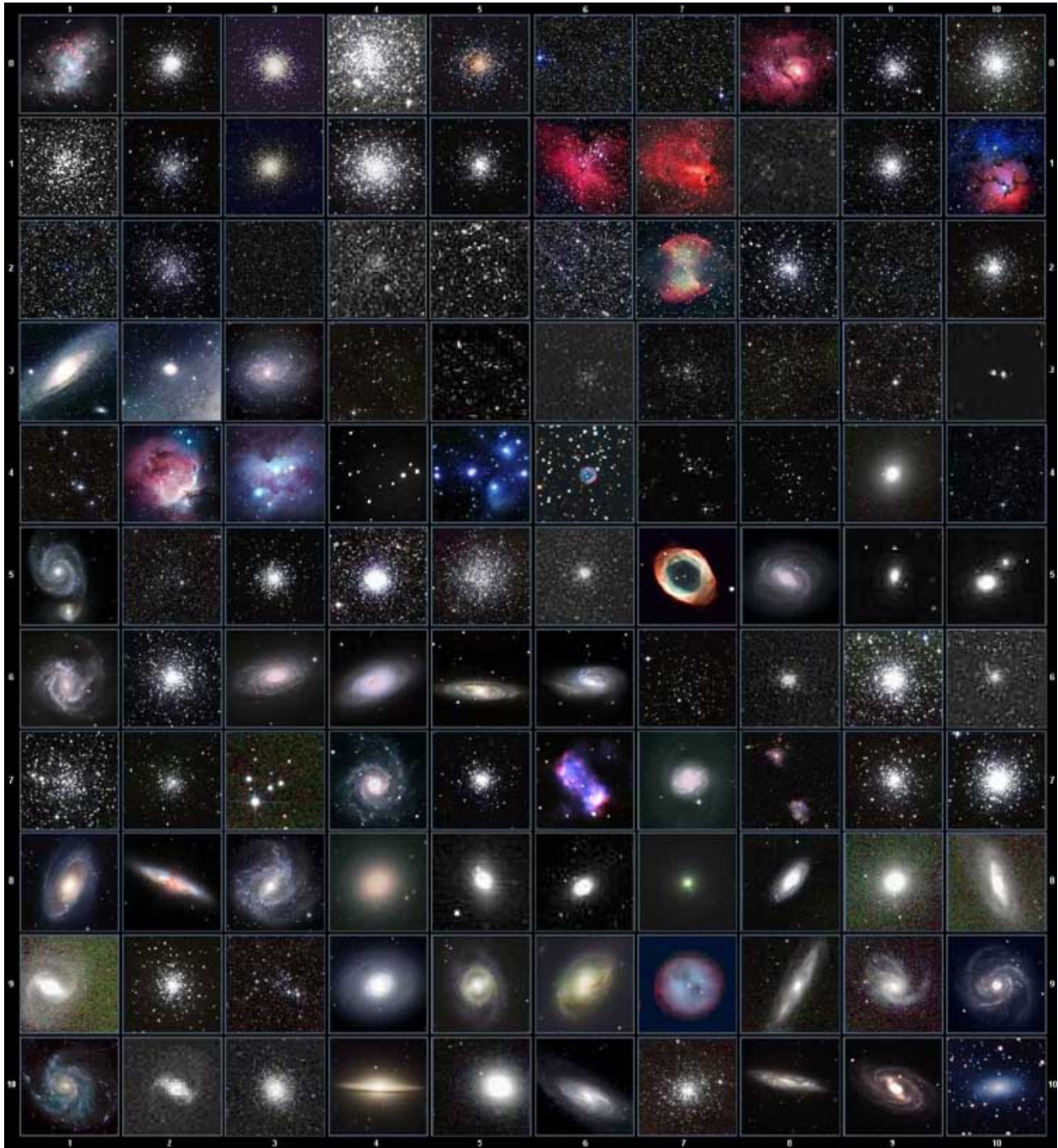

This table is licensed under the [GNU Free Documentation License](https://www.gnu.org/licenses/fdl.html). It uses material from the [Wikipedia article List of Messier objects](https://en.wikipedia.org/wiki/List_of_Messier_objects)

Modern Constellations

No.	Constellation	Abbreviation
1	Andromeda	And
2	Antlia	Ant
3	Apus	Aps
4	Aquarius	Aqr
5	Aquila	Aql
6	Ara	Ara
7	Aries	Ari
8	Auriga	Aur
9	Boötes	Boo
10	Caelum	Cae
11	Camelopardalis	Cam
12	Cancer	Cnc
13	Canes Venatici	CVn
14	Canis Major	CMa
15	Canis Minor	CMi
16	Capricornus	Cap
17	Carina	Car
18	Cassiopeia	Cas
19	Centaurus	Cen
20	Cepheus	Cep
21	Cetus	Cet
22	Chamaeleon	Cha
23	Circinus	Cir
24	Columba	Col
25	Coma Berenices	Com
26	Corona Australis	CrA
27	Corona Borealis	CrB
28	Corvus	Crv
29	Crater	Crt
30	Crux	Cru
31	Cygnus	Cyg
32	Delphinus	Del
33	Dorado	Dor
34	Draco	Dra
35	Equuleus	Equ
36	Eridanus	Eri
37	Fornax	For
38	Gemini	Gem
39	Grus	Gru
40	Hercules	Her
41	Horologium	Hor
42	Hydra	Hya
43	Hydrus	Hyi
44	Indus	Ind

No.	Constellation	Abbreviation
45	Lacerta	Lac
46	Leo	Leo
47	Leo Minor	LMi
48	Lepus	Lep
49	Libra	Lib
50	Lupus	Lup
51	Lynx	Lyn
52	Lyra	Lyr
53	Mensa	Men
54	Microscopium	Mic
55	Monoceros	Mon
56	Musca	Mus
57	Norma	Nor
58	Octans	Oct
59	Ophiuchus	Oph
60	Orion	Ori
61	Pavo	Pav
62	Pegasus	Peg
63	Perseus	Per
64	Phoenix	Phe
65	Pictor	Pic
66	Pisces	Psc
67	Piscis Austrinus	PsA
68	Puppis	Pup
69	Pyxis	Pyx
70	Reticulum	Ret
71	Sagitta	Sge
72	Sagittarius	Sgr
73	Scorpius	Sco
74	Sculptor	Scl
75	Scutum	Sct
76	Serpens	Ser
77	Sextans	Sex
78	Taurus	Tau
79	Telescopium	Tel
80	Triangulum	Tri
81	Triangulum Australe	TrA
82	Tucana	Tuc
83	Ursa Major	UMa
84	Ursa Minor	UMi
85	Vela	Vel
86	Virgo	Vir
87	Volans	Vol
88	Vulpecula	Vul

GOTONOVA Named Star List for 8402G

001 Acamar	049 Ascella	097 Kaus Australis	145 Rassalas
002 Achernar	050 Asellus Australis	098 Kaus Borealis	146 Rasagethi
003 Acrux	051 Asellus Borealis	099 Kaus Media	147 Rasalhague
004 Acubens	052 Aspidiske	100 Keid	148 Rastaba
005 Adhafera	053 Atik	101 Kitalpha	149 Regulus
006 Adhara	054 Atlas	102 Kochab	150 Rigel
007 Al Na'ir	055 Atria	103 Kornephoros	151 Rigel Kentaurus
008 Albali	056 Avoir	104 Kurhah	152 Ruchbah
009 Alberio	057 Azha	105 Lesath	153 Rukbat
010 Alchibar	058 Baten Kaitos	106 Maia	154 Sabik
011 Alcor	059 Beid	107 Marfik	155 Sadachbia
012 Alcyone	060 Bellatrix	108 Markab	156 Sadalbari
013 Aldebaran	061 Betelgeuse	109 Matar	157 Sadalmelik
014 Alderamin	062 Biham	110 Mebsuta	158 Sadalsuud
015 Alfirk	063 Canopus	111 Megrez	159 Sadr
016 Algedi	064 Capella	112 Meissa	160 Saiph
017 Algenib	065 Caph	113 Mekbuda	161 Scheat
018 Algiebra	066 Castor	114 Menkalinan	162 Schedar
019 Algol	067 Celabrai	115 Menkar	163 Seginus
020 Algorab	068 Celaeno	116 Menkent	164 Shaula
021 Alhena	069 Chara	117 Menkib	165 Sheiak
022 Alioth	070 Chertan	118 Merak	166 Sheratan
023 Alkaid	071 Cor Caroli	119 Merope	167 Sirius
024 Alkalurops	072 Cursa	120 Mesartim	168 Skat
025 Alkes	073 Dabih	121 Miaplacidus	169 Spica
026 Almach	074 Deneb	122 Mintaka	170 Sterope
027 Alnasl	075 Deneb Algedi	123 Mira	171 Sulafat
028 Alnilam	076 Deneb Kaitos	124 Mirach	172 Syrma
029 Alnitak	077 Denebola	125 Mirfak	173 Talitha
030 Alphard	078 Dubhe	126 Mirzam	174 Tania Australis
031 Alphecca	079 Edasich	127 Mizar	175 Tania Borealis
032 Alpheratz	080 Electra	128 Muphrid	176 Tarazed
033 Alrakis	081 Elnath	129 Muscida	177 Taygeta
034 Alrescha	082 Eltanin	130 Nashira	178 Thuban
035 Alshain	083 Enif	131 Nekkar	179 Unukalhai
036 Altair	084 Errai	132 Nihal	180 Vega
037 Altais	085 Fomalhaut	133 Nunki	181 Vindemiatrix
038 Alterf	086 Furd	134 Nusakan	182 Wasat
039 Aludra	087 Gacrux	135 Peacock	183 Wazn
040 Alula Australis	088 Giasar	136 Phact	184 Yed Posterior
041 Alula Borealis	089 Gienah	137 Phecda	185 Yed Prior
042 Alya	090 Gomeisa	138 Pherkad	186 Zaniah
043 Ancha	091 Graffias	139 Pleione	187 Zaurak
044 Ankaa	092 Groombridge 1830	140 Polaris	188 Zavijava
045 Antares	093 Grumium	141 Pollux	189 Zosma
046 Arcturus	094 Hamal	142 Porrima	190 Zubenelgenubi
047 Arkab	095 Homan	143 Procyon	191 Zubeneschamali
048 Arneb	096 Izar	144 Propus	

GOTONOVA Double Star List

for 8402G

No.	Object	Const	SAO	Name
1	Eta	Cas	21732	Achird
2	Alpha	Psc	110291	Alrisha
3	Theta	Per	38288	
4	Alpha	For	168373	Fornacis
5	Alpha	Aur	40186	Capella
6	Sigma	Ori	132406	
7	Mu	Ori	113389	
8	Alpha	CMa	151881	Sirius
9	Delta	Gem	79294	Wasat
10	Alpha	Gem	60198	Castor
11	Alpha	CMi	115756	
12	Epsilon	Hya	117112	
13	HR 3579		42642	
14	Kapa	UMa	42661	
15	Psi	Vel	221234	
16	Gamma	Leo	81298	Algieba
17	HR 4167		222199	
18	Mu	Vel	222321	
19	Alpha	UMa	15384	Dubhe
20	Zeta	UMa	28737	Mizar
21	Iota	Leo	99587	
22	Gamma	Cen	223603	
23	Gamma	Vir	138917	Porrima
24	Beta	Mus	252019	
25	HR 5089		204545	
26	Alpha	Cen	252838	
27	Zeta	Boo	101145	
28	Gamma	Lup	225938	
29	Gamma	CrA	83958	
30	Xi	Sco	159665	
31	Alpha	Sco	184415	Antares
32	Lambda	Oph	121658	Marfic
33	Zeta	Her	65485	
34	Eta	Oph	160332	Sabik
35	70	Oph	123107	
36	Zeta	Sgr	187600	Ascella
37	Delta	Cyg	48796	
38	Beta	Del	106316	Rotanev
39	Tau	Cyg	71121	
40	Epsilon	Lyr	67310	double double

Appendix D. Set Up USB-PC Connection

Before a computer being used to control the mount or update the firmware, a connection between PC and 8402G Hand Controller has to be established. There are two versions of 8402 HCs, namely 8402G and 8402A. The USB2COM chipsets used in these two HCs are different. To identify your HC's version, please read the initial LCD screen when the mount is turned on.

If it is an 8402G Hand Controller, the LCD screen shows following when it is turned on:



1. Install PL-2303 (usb2com) driver

Download USB to COM driver for 8402G hand controller from iOptron website and double click on the compressed file:

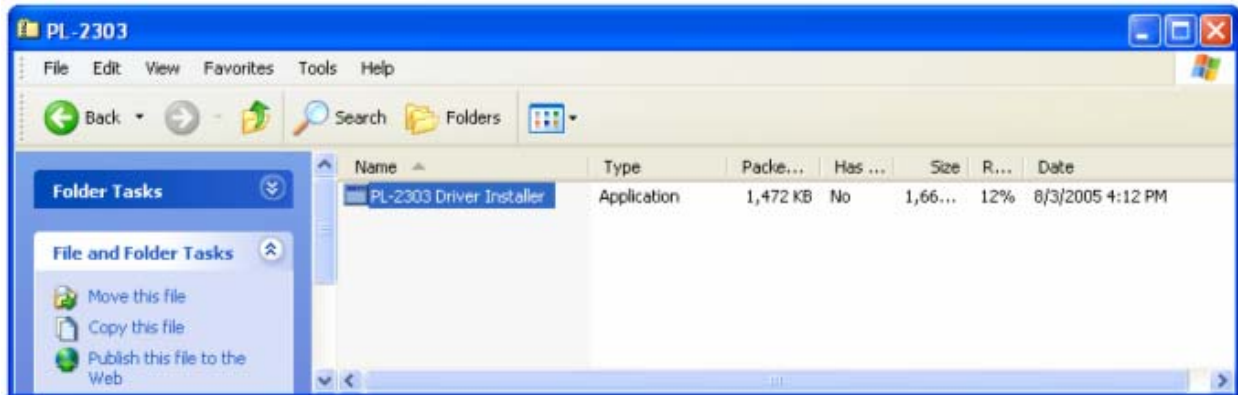

Double click on it, and you will see:

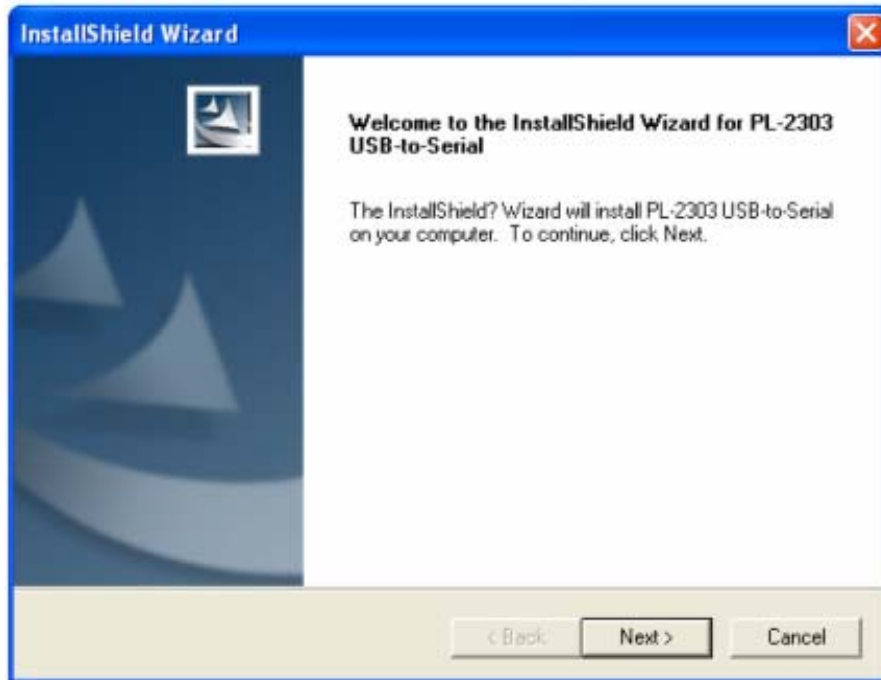

Click "Next".



When finished installation, click "Finish"

- 2. Plug the USB cable into a USB port on your PC, plug the other end of the USB cable to hand controller. Turn the mount power on.**

3. Install the Hardware

The computer will find a new hardware and install the driver automatically.

Now your computer should be ready for Firmware Upgrading, computer communication with the mount via ASCOM platform and planetarium software applications. However, you need to find assigned COM port number for the USB connection. To do so, right click "My Computer", and click "Properties"



Click "Hardware", click "Device Manager"

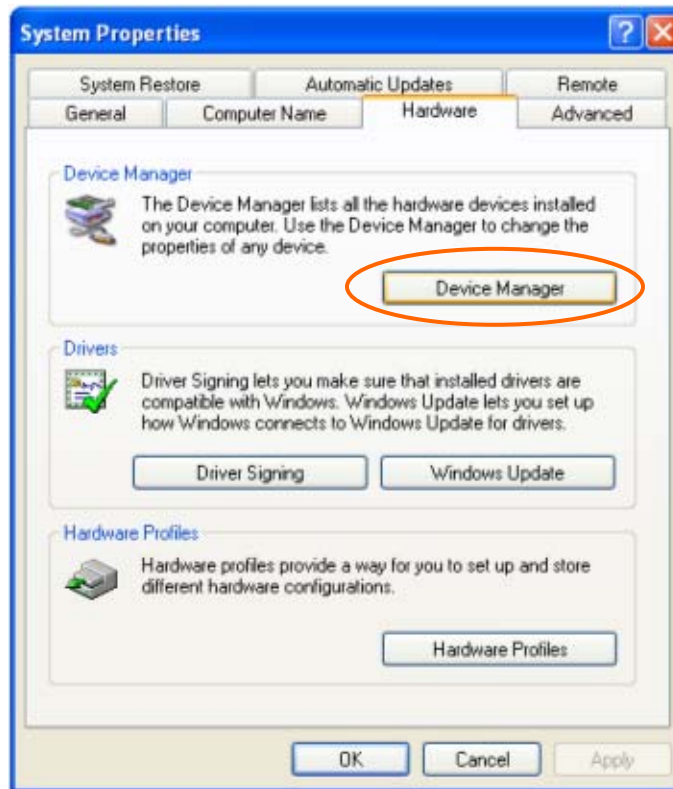

Double click on “Ports (COM & LPT)”, find out the COM number and write it down (in the following figure, it is COM4)

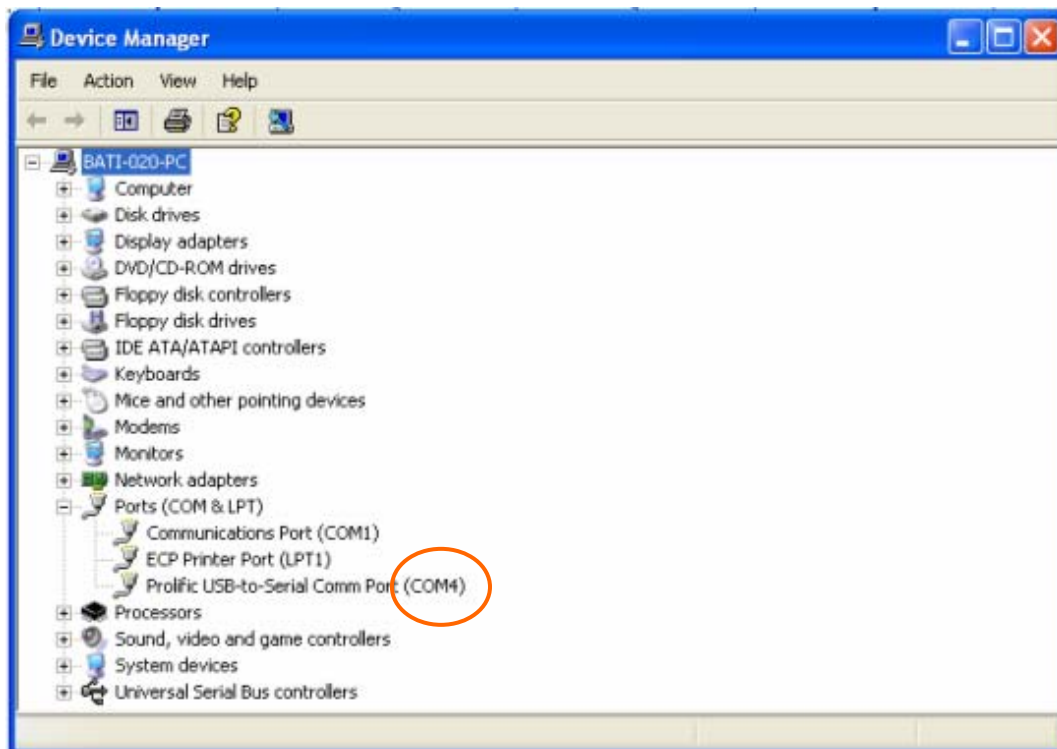

Appendix E. Firmware Upgrade

1. Download and install Firmware Downloader from iOptron Website
2. Double click and open “iOptron Downloader”

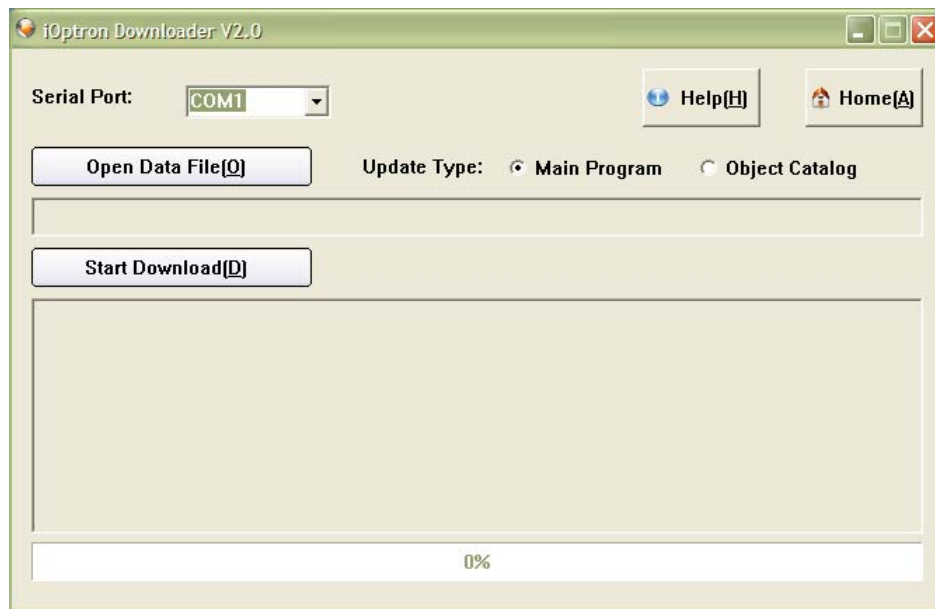

On the interface, select appropriate port using pull-down menu (in this case, COM4):

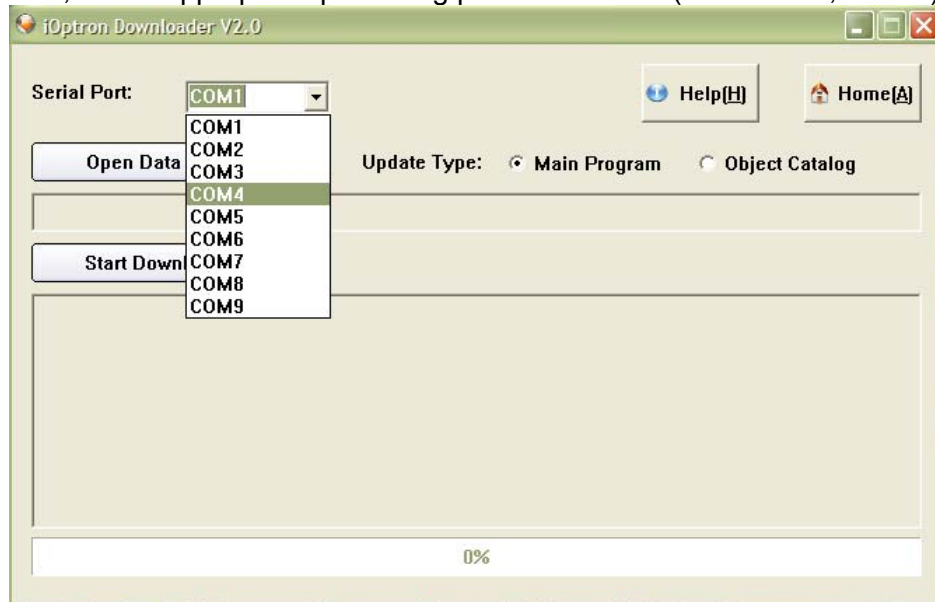

Click “Open Data File”, and select appropriate “.bin” file that matches your hand controller.

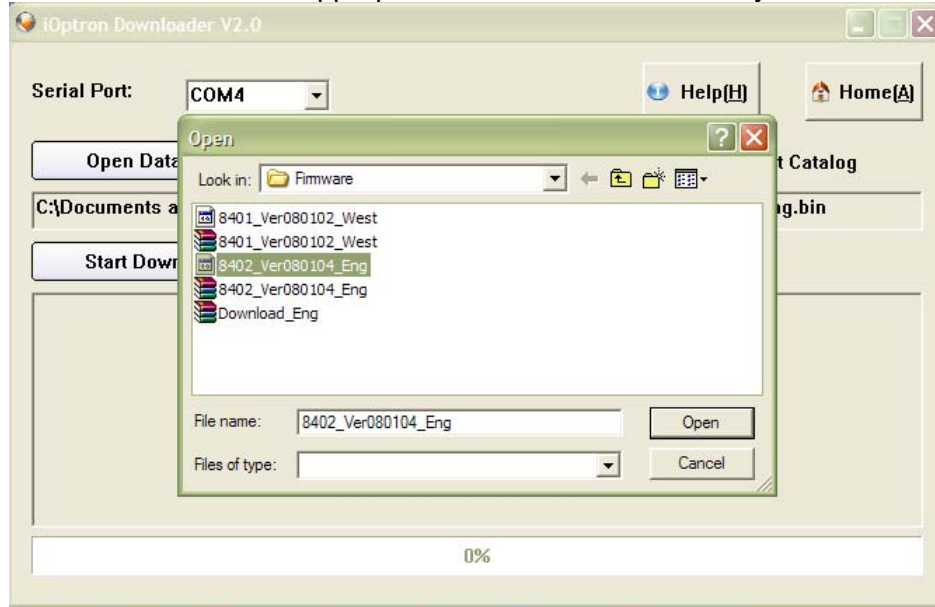

and click “Open”. Select “Main Program” **ONLY** in Update Type.

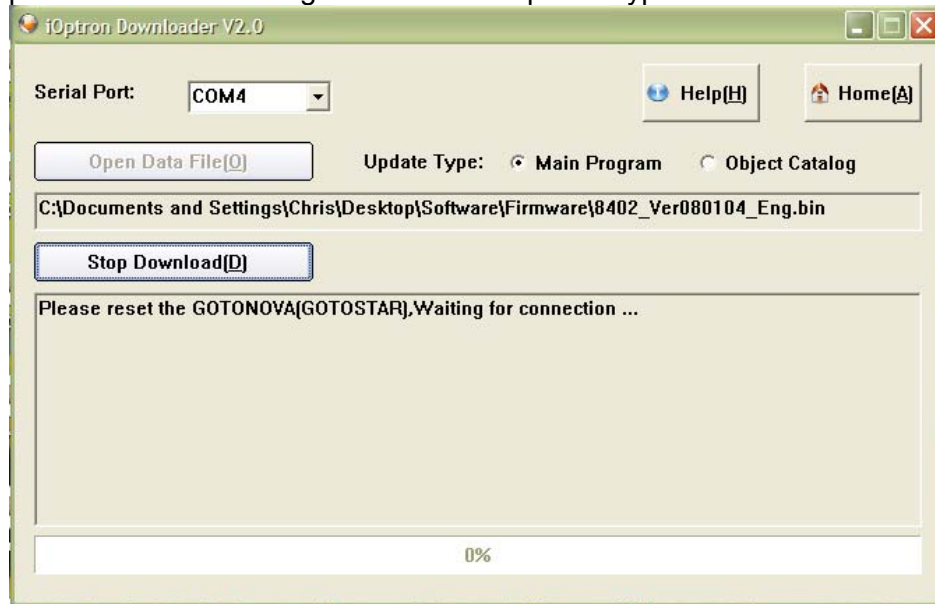

Click “Start Download”

It shows “Please reset GOTONOVA[GOTOSTAR], waiting for connection...”

On the hand controller, press “MENU”, and using ▼▲ scroll to select “Set up controller”, press “ENTER”, then select “Upgrade firmware”, press “ENTER” and the upgrade starts.

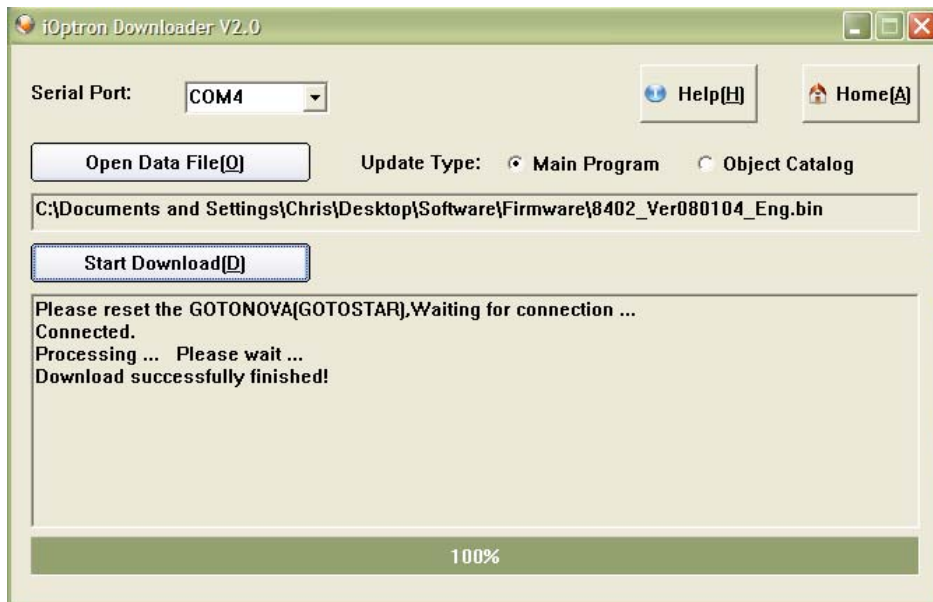
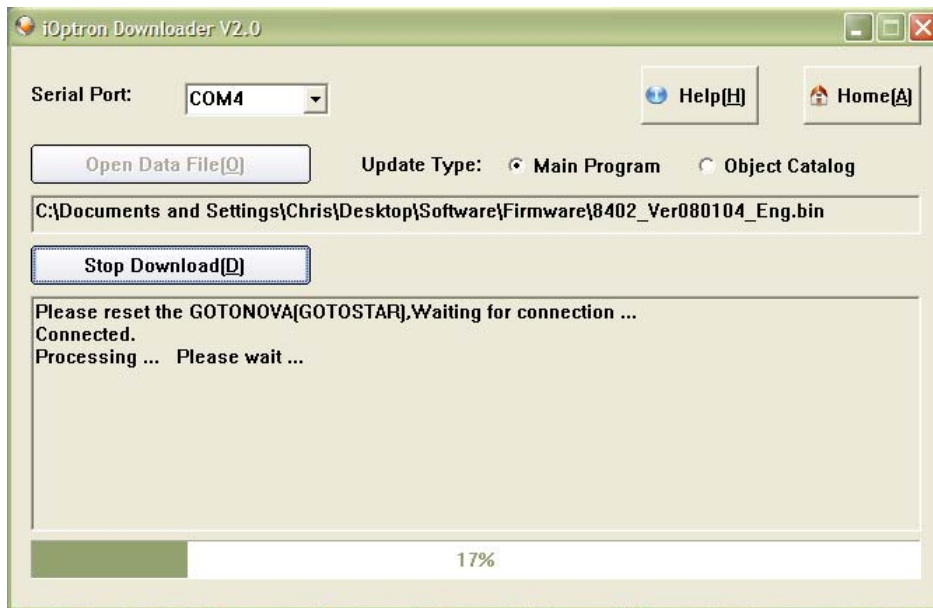

Now the upgrade is finished.

Typical Errors:

1. Invalid Port Number: in Device Manager, make sure you have the correct COM port number for "Prolific USB-to-Serial Comm Port."
2. Wrong ".bin" file: make sure you have the correct ".bin" file for firmware upgrade.
3. Wrong downloader, you should use iOptron Downloader instead of the Flash Downloader.
4. Use PL-2303 driver provided by iOptron. The newest version from Prolific may not work properly for iOptron's hand controller.

Appendix F. Use a PC to Control an iOptron Mount

In general you need the followings to use a PC to control a SmartStar-G mount,

1. Download USB2COM driver (PL-2303, zip file for 8402G)
<http://www.ioptron.com/support.aspx?catalog=28>;
2. Install USB2COM and establish the connection between the mount and the PC (see instruction);
3. ASCOM platform (download from <http://ascom-standards.org/>);
4. iOptron ASCOM drive (download it from iOptron website, <http://www.ioptron.com/support.aspx?catalog=28>) iOptronAscomSetupV1.02.exe; and
5. Planetarium software.

Some company has integrated iOptron's products into their planetarium software, such as Voyage and The Sky X Pro. Therefore, an ASCOM plug-in will not be needed. Most planetarium software can be used to control iOptron's product via ASCOM.

Some other ASCOM drivers, such as LX200 Generic ASCOM driver and AstroPhysics GTO driver, are also compatible to SmartStar® mount.

IOPTRON ONE YEAR LIMITED WARRANTY

A. iOptron warrants your telescope, mount, or controller to be free from defects in materials and workmanship for one year. iOptron will repair or replace such product or part which, upon inspection by iOptron, is found to be defective in materials or workmanship. As a condition to the obligation of iOptron to repair or replace such product, the product must be returned to iOptron together with proof-of-purchase satisfactory to iOptron.

B. The Proper Return Authorization Number must be obtained from iOptron in advance of return. Call iOptron at 1.866.399.4587 to receive the number to be displayed on the outside of your shipping container.

All returns must be accompanied by a written statement stating the name, address, and daytime telephone number of the owner, together with a brief description of any claimed defects. Parts or product for which replacement is made shall become the property of iOptron.

The customer shall be responsible for all costs of transportation and insurance, both to and from the factory of iOptron, and shall be required to prepay such costs.

iOptron shall use reasonable efforts to repair or replace any telescope, mount, or controller covered by this warranty within thirty days of receipt. In the event repair or replacement shall require more than thirty days, iOptron shall notify the customer accordingly. iOptron reserves the right to replace any product which has been discontinued from its product line with a new product of comparable value and function.

This warranty shall be void and of no force or effect in the event a covered product has been modified in design or function, or subjected to abuse, misuse, mishandling or unauthorized repair. Further, product malfunction or deterioration due to normal wear is not covered by this warranty.

IOPTRON DISCLAIMS ANY WARRANTIES, EXPRESS OR IMPLIED, WHETHER OF MERCHANTABILITY OF FITNESS FOR A PARTICULAR USE, EXCEPT AS EXPRESSLY SET FORTH HERE. THE SOLE OBLIGATION OF IOPTRON UNDER THIS LIMITED WARRANTY SHALL BE TO REPAIR OR REPLACE THE COVERED PRODUCT, IN ACCORDANCE WITH THE TERMS SET FORTH HERE. IOPTRON EXPRESSLY DISCLAIMS ANY LOST PROFITS, GENERAL, SPECIAL, INDIRECT OR CONSEQUENTIAL DAMAGES WHICH MAY RESULT FROM BREACH OF ANY WARRANTY, OR ARISING OUT OF THE USE OR INABILITY TO USE ANY IOPTRON PRODUCT. ANY WARRANTIES WHICH ARE IMPLIED AND WHICH CANNOT BE DISCLAIMED SHALL BE LIMITED IN DURATION TO A TERM OF TWO YEARS FROM THE DATE OF ORIGINAL RETAIL PURCHASE.

Some states do not allow the exclusion or limitation of incidental or consequential damages or limitation on how long an implied warranty lasts, so the above limitations and exclusions may not apply to you.

This warranty gives you specific legal rights, and you may also have other rights which vary from state to state.

iOptron reserves the right to modify or discontinue, without prior notice to you, any model or style telescope.

If warranty problems arise, or if you need assistance in using your telescope, mount, or controller contact:

iOptron Corporation
Customer Service Department
6X Gill Street
Woburn, MA 01801
www.ioptron.com
Tel. (866)399-4597
Fax. (781)935-2860
Monday-Friday 9AM-5PM EST

NOTE: This warranty is valid to U.S.A. and Canadian customers who have purchased this product from an authorized iOptron dealer in the U.S.A. or Canada or directly from iOptron. Warranty outside the U.S.A. and Canada is valid only to customers who purchased from an iOptron Distributor or Authorized iOptron Dealer in the specific country. Please contact them for any warranty