



Advanced Series Advanced Series GT

INSTRUCTION MANUAL

C8-N / C8-NGT



C10-N / C10-N

INTRODUCTION.....	4
Warning	4
ASSEMBLY	7
Setting up the Tripod.....	7
Attaching the Equatorial Mount.....	7
Attaching the Center Leg Brace.....	8
Installing the Counterweight Bar.....	8
Installing the Counterweight.....	9
Attaching the Hand Control Holder.....	9
Attaching the Slow Motion Knobs.....	9
Attaching the Telescope Tube to the Mount.....	10
Installing the Finderscope.....	11
Installing the Eyepieces.....	11
Balancing the Tube in R.A.....	12
Adjusting the Mount.....	13
Adjusting the Mount in Altitude.....	13
Adjusting the Mount in Azimuth.....	14
Attaching the Declination Cables (For GT Models Only).....	14
Powering the Telescope.....	14
HAND CONTROL.....	15
Hand Control Operation.....	16
Alignment Procedures.....	17
Startup Procedure.....	17
Auto Align.....	18
Auto Three-Star Align.....	18
Quick-Align.....	19
Last Alignment.....	19
Re-Alignment.....	19
Object Catalog.....	20
Selecting an Object.....	20
Slewing to an Object.....	20
Finding Planets.....	20
Tour Mode.....	21
Constellation Tour.....	21
Direction Buttons.....	21
Rate Button.....	21
Setup Procedures.....	22
Tracking Mode.....	22
Tracking Rate.....	22
Date/Time.....	22
User Defined Objects.....	22
Get RA/DEC.....	23
Goto R.A/Dec.....	23
Identify.....	23
Precise GoTo.....	24
Scope Setup Features.....	24
Setup Time-Site.....	24
Anti-backlash.....	24
Filter Limits.....	24
Direction Buttons.....	25
Goto Approach.....	25
Autoguide Rates.....	25
Azimuth Limits.....	25
East/West Filtering.....	26
Utility Features.....	26
Calibrate Goto.....	26
Home Position.....	26
Polar Align.....	26
Light Control.....	27
Factory Settings.....	27
Version.....	27
Get Alt-Az.....	27
Goto Alt-Az.....	27
Hibernate.....	27
Turn On/Off GPS.....	27

TELESCOPE BASICS	29
Image Orientation	29
Focusing.....	30
Aligning the Finderscope	30
Calculating Magnification.....	30
Determining Field of View	31
General Observing Hints.....	31
ASTRONOMY BASICS.....	32
The Celestial Coordinate System	32
Motion of the Stars.....	33
Finding the North Celestial Pole	35
Declination Drift Method of Polar Alignment.....	36
CELESTIAL OBSERVING.....	37
Observing the Moon.....	37
Lunar Observing Hints.....	37
Observing the Planets.....	37
Observing the Sun.....	37
Solar Observing Hints.....	38
Observing Deep Sky Objects	38
Seeing Conditions	38
Transparency.....	38
Sky Illumination.....	38
Seeing	38
ASTROPHOTOGRAPHY	40
Piggyback	40
Short Exposure Prime Focus Photography.....	41
Terrestrial Photography.....	42
Metering.....	42
Reducing Vibration.....	42
Auto Guiding	43
TELESCOPE MAINTENANCE	44
Care and Cleaning of the Optics.....	44
Collimation	44
OPTIONAL ACCESSORIES.....	48
APPENDIX A – TECHNICAL SPECIFICATIONS.....	51
APPENDIX B – GLOSSARY OF TERMS.....	52
APPENDIX C – LONGITUDES AND LATITUDES.....	55
APPENDIX D – RS-232 CONNECTION.....	60
APPENDIX E – TIME ZONE MAP.....	62
SKY MAPS.....	64



Introduction

Congratulations on your purchase of the Celestron Advanced Series telescope (AST)! The Advanced Series of telescopes come in standard (non-computerized) and computerized GT models. The Advanced Series is made of the highest quality materials to ensure stability and durability. All this adds up to a telescope that gives you a lifetime of pleasure with a minimal amount of maintenance. Furthermore, your Celestron telescope is versatile — it will grow as your interest grows.

The Advanced GT Series ushers in the next generation of computer automated telescopes. The Celestron Advanced GT series continues in this proud tradition combining large aperture optics with the sophistication and ease of use of our computerized GoTo mount.

If you are new to astronomy, you may wish to start off by using the built-in Sky Tour feature, which commands the telescopes to find the most interesting objects in the sky and automatically slews to each one. Or if you are an experienced amateur, you will appreciate the comprehensive database of over 40,000 objects, including customized lists of all the best deep-sky objects, bright double stars and variable stars. No matter at what level you are starting out, the Advanced Series telescopes will unfold for you and your friends all the wonders of the Universe.

Some of the many standard features of the Advanced GT include:

- Fully enclosed optical encoders for position location.
- Ergonomically designed mount that disassembles into compact and portable pieces.
- Database filter limits for creating custom object lists.
- Storage for programmable user defined objects; and

Many other high performance features!

The AST's deluxe features combine with Celestron's legendary optical systems to give amateur astronomers the most sophisticated and easy to use telescopes available on the market today.

Take time to read through this manual before embarking on your journey through the Universe. It may take a few observing sessions to become familiar with your telescope, so you should keep this manual handy until you have fully mastered your telescope's operation. The Advanced GT hand control has built-in instructions to guide you through all the alignment procedures needed to have the telescope up and running in minutes. Use this manual in conjunction with the on-screen instructions provided by the hand control. The manual gives detailed information regarding each step as well as needed reference material and helpful hints guaranteed to make your observing experience as simple and pleasurable as possible.

Your telescope is designed to give you years of fun and rewarding observations. However, there are a few things to consider before using your telescope that will ensure your safety and protect your equipment.

Warning



- ❑ **Never look directly at the sun with the naked eye or with a telescope (unless you have the proper solar filter). Permanent and irreversible eye damage may result.**
- ❑ Never use your telescope to project an image of the sun onto any surface. Internal heat build-up can damage the telescope and any accessories attached to it.
- ❑ Never use an eyepiece solar filter or a Herschel wedge. Internal heat build-up inside the telescope can cause these devices to crack or break, allowing unfiltered sunlight to pass through to the eye.

Never leave the telescope unsupervised, either when children are present or adults who may not be familiar with the correct operating procedures of your telescope.

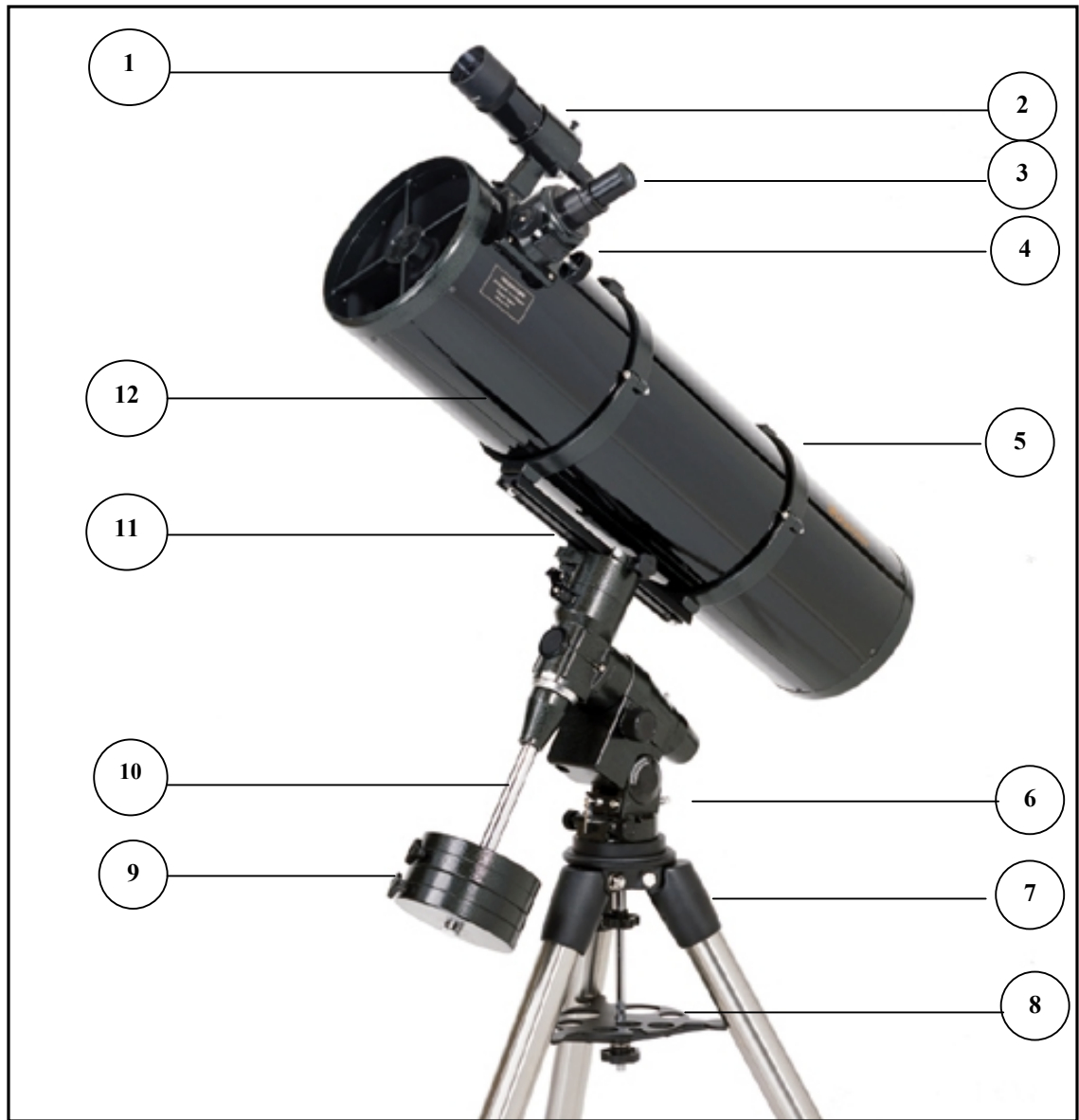

**Fig 1-1 - The Advanced Series Newtonian
(C8-N Shown)**

1.	Finderscope	7.	2" Steel Tripod
2.	Finderscope Bracket	8.	Center Leg Brace / Accessory Tray
3.	Eyepiece	9.	Counterweights
4.	Focuser	10.	Counterweight Bar
5.	Tube Rings	11.	Dovetail Slide Bar
6.	Latitude Adjustment Lever	12.	Optical Tube

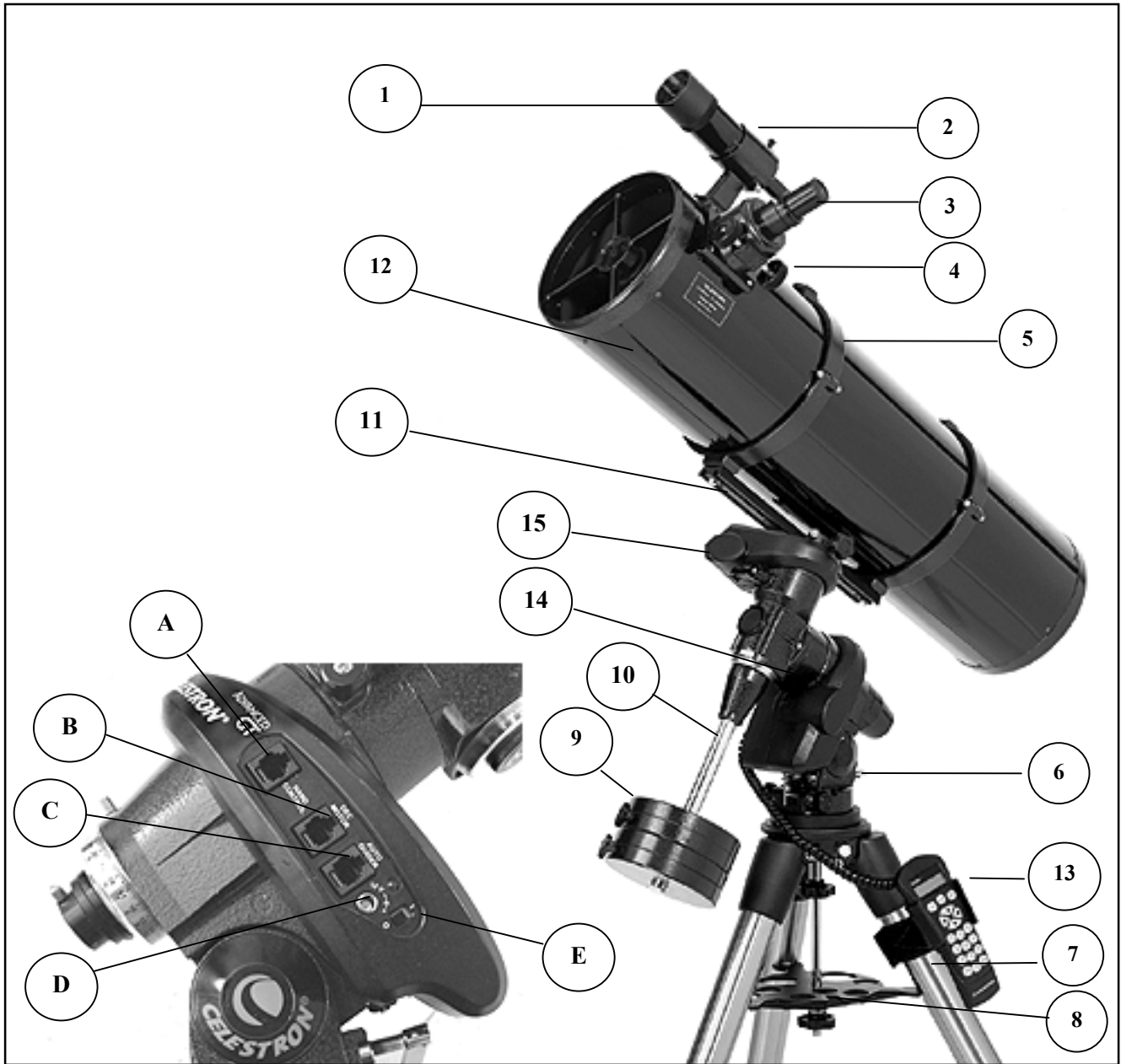

**Fig 1-2 - The Advanced Series GT Newtonian
(C8-NGT Shown)**

1.	Finderscope	8.	Center Leg Brace / Accessory Tray
2.	Finderscope Bracket	9.	Counterweights
3.	Eyepiece	10.	Counterweight Bar
4.	Focuser	11.	Dovetail Slide Bar
5.	Tube Rings	12.	Optical Tube
6.	Latitude Adjustment Lever	13.	Hand Control
7.	2" Steel Tripod	14.	R.A. Motor Drive / Control Panel
	CONTROL PANEL	15.	Declination Motor Drive
A	Hand Control Port		
B	DEC Motor Port	D	12v Output Jack
C	Autoguide Port	E	ON/OFF Switch



This section covers the assembly instructions for your Celestron Advanced Series Telescope (AST). Your AST telescope should be set up indoors the first time so that it is easy to identify the various parts and familiarize yourself with the correct assembly procedure before attempting it outdoors.

	31061 / 31062	11047 / 11048
	C8-N	C10-N
Diameter	200mm (8.0") reflector	254mm (10") reflector
Focal Length	1000mm F/5 Parabola	1200mm F/4.7 Parabola
Eyepiece	20mm - 1.25" (50x)	20mm - 1.25" (60x)
Finderscope	9x50	9x50
Mount	CG-5 Equatorial	CG-5 Equatorial
Tripod	2" Stainless Steel	2" Stainless Steel
Software	The Sky L1	The Sky L1
Counterweight	2-11lb	3-11lb

Setting up the Tripod

The CG-5 tripod comes with an all metal center leg brace / accessory tray to give rock solid support to the mount. The tripod comes fully assembled with a metal plate, called the tripod head, that holds the legs together at the top. In addition, there is a central rod that extends down from the tripod head that attaches the equatorial mount to the tripod. To set up the tripod:

1. Stand the tripod upright and pull the tripod legs apart until each leg is fully extended. The tripod will now stand by itself. Once the tripod is set up, you can adjust the height at which it stands.
2. Loosen the lever on the leg clamp so that the tripod leg can be adjusted.
3. Slide the center portion of the tripod leg away from the tripod head until it is at the desired height.
4. Tighten the levers on each leg clamp to hold the legs in place.

Attaching the Equatorial Mount

The equatorial mount allows you to tilt the telescope's axis of rotation so that you can track the stars as they move across the sky. The CG-5 mount is a German equatorial mount that attaches to the tripod head. On one side of the tripod head there is a metal alignment peg for aligning the mount. This side of the tripod will face north when setting up for an astronomical observing session. To attach the equatorial head:

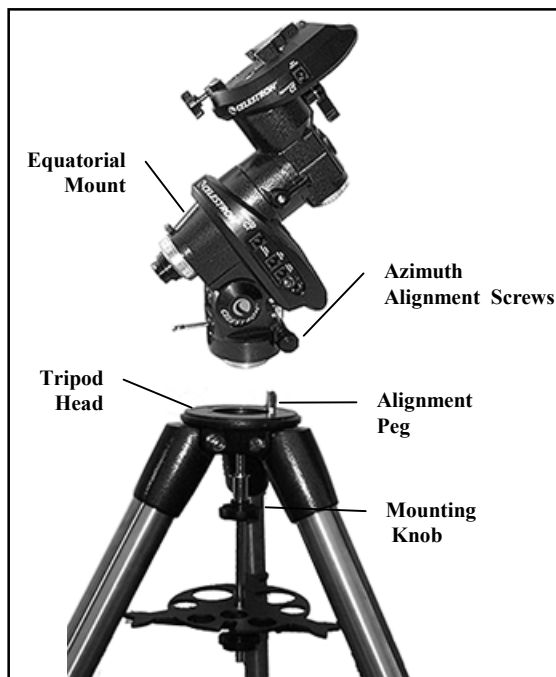

Figure 2-3

1. Locate the azimuth adjustment screws on the equatorial mount.
2. Retract the screws so they no longer extend into the azimuth housing on the mount. **Do NOT remove the screws since they are needed later for polar alignment.**
3. Hold the equatorial mount over the tripod head so that the azimuth housing is above the metal peg.
4. Place the equatorial mount on the tripod head so that the two are flush.
5. Tighten the knob (attached to the central rod) on the underside of the tripod head to hold the equatorial mount firmly in place.

Attaching the Center Leg Brace

1. Slide the accessory tray over the central rod so that each arm of the tray is pushing against the inside of the tripod legs.
2. Thread the accessory tray knob on to the central rod and tighten.

Installing the Counterweight Bar

To properly balance the telescope, the mount comes with a counterweight bar and at least one counterweight (depending on model). To install the counterweight bar:

1. Locate the opening in the equatorial mount on the DEC axis
2. Thread the counterweight bar into the opening until tight.
3. Tighten the counterweight bar lock nut fully for added support (see fig 2-5).

Once the bar is securely in place you are ready to attach the counterweight.

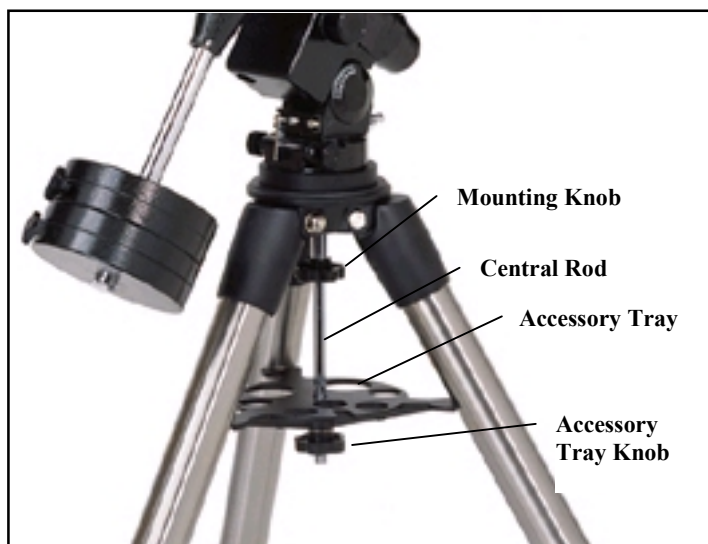

Figure 2-4

Since the fully assembled telescope can be quite heavy, position the mount so that the polar axis is pointing towards north before the tube assembly and counterweights are attached. This will make the polar alignment procedure much easier.

Installing the Counterweight

Depending on which AST telescope you have, you will receive either two or three counterweights. To install the counterweight(s):

1. Orient the mount so that the counterweight bar points toward the ground .
2. Remove the counterweight safety screw on the end of the counterweight bar (i.e., opposite the end that attaches to the mount).
3. Loosen the locking screw on the side of the counterweight.
4. Slide the counterweight onto the shaft (see Figure 2-5).
5. Tighten the locking screw on the side of the weight to hold the counterweight in place.
6. Replace the counterweight safety screw.

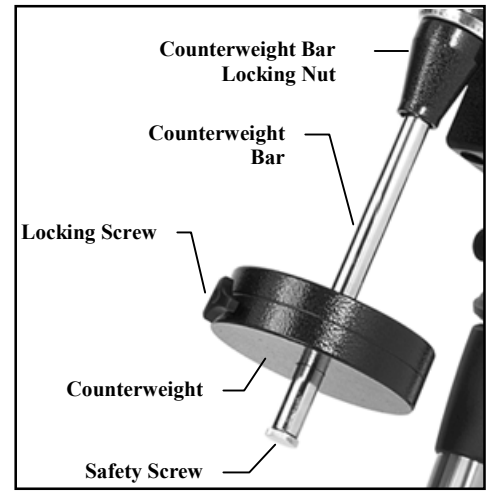

Figure 2-5

Attaching the Hand Control Holder (Advanced GT Models Only)

The Advanced GT telescope models come with a hand control holder to place the computerized hand control. The hand control holder comes in two pieces: the leg clamp that snaps around the tripod leg and the holder which attaches to the leg clamp. To attach the hand control holder:

1. Place the leg clamp up against one of the tripod legs and press firmly until the clamp wraps around the leg.
2. Slide the back of the hand control holder downward into the channel on the front of the legs clamp (see Fig 2-6) until it snaps into place.

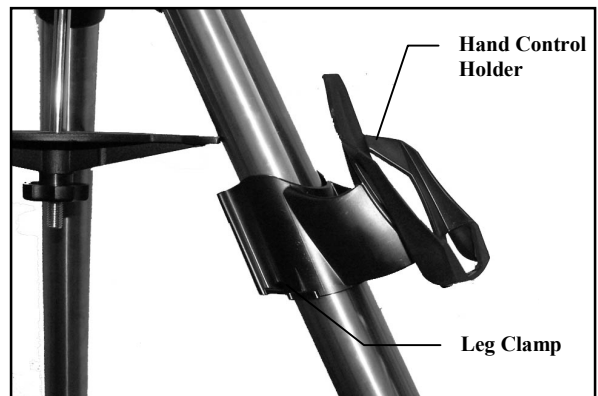

Figure 2-6

Attaching the Slow Motion Knobs (For Non-GT Models Only)

The Advanced Series (non-GT models) comes with two slow motion control knobs that allows you to make fine pointing adjustments to the telescope in both R.A. and Declination. To install the knobs:

1. Locate the hard plastic shell under the R.A. shafts.
2. Remove either of the two oval tabs by pulling tightly.
3. Line up the flat area on the inner portion of the R.A. slow motion knob with the flat area on the R.A. shaft (see Fig 2-7).
4. Slide the R.A. slow motion knob onto the R.A. shaft.

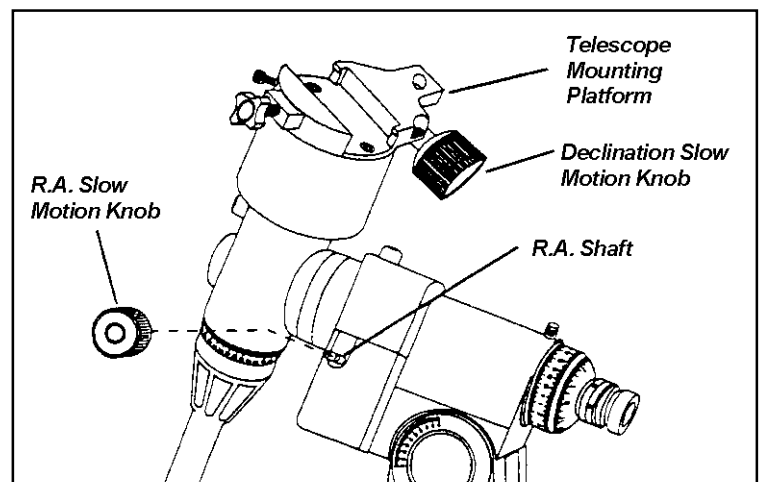

Figure 2-7

The knob is a tension fit, so sliding it on holds it in place. As mentioned above, there are two R.A. shafts, one on either side of the mount. It makes no difference which shaft you use since both work the same. Use whichever one you find more convenient. If, after a few observing sessions, you find the R.A. slow motion knob is more accessible from the other side, pull firmly to remove the knob, then install it on the opposite side.

- The DEC slow motion knob attaches in the same manner as the R.A. knob. The shaft that the DEC slow motion knob fits over is toward the top of the mount, just below the telescope mounting platform. Once again, you have two shafts to choose from. Use the shaft that is pointing toward the ground. This makes it easy to reach while looking through the telescope, something which is quite important when you are observing.

Attaching the Telescope Tube to the Mount

Advanced
GT Users!

The telescope attaches to the mount via a dovetail slide bar mounting bracket which is mounted along the bottom of the telescope tube. **Before you attach the optical tube, make sure that the declination and right ascension clutch knobs are tight.** This will ensure that the mount does not move suddenly while attaching the telescope. To mount the telescope

tube:

In order for the GT computerized mount to function properly, before installing the optical tube, the mounting platform must be positioned so that the Declination Index Marks are aligned (see Fig 2-8).

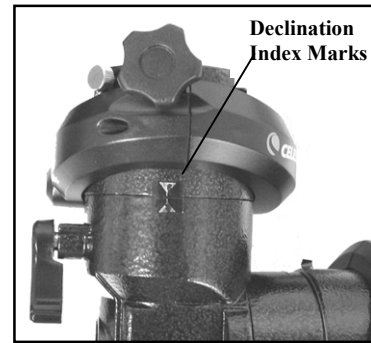

Figure 2-8

- Locate the mounting bracket from the box containing the equatorial mount head.
- Attach the mounting bracket to the tube rings so that the tapered (narrow) end is against the bottom of the tube rings.
- Loosen the hand knob on the side of the CG-5 mount.
- Slide the mounting bracket that is attached to the bottom of the tube rings into the recess on the top of the mounting platform (see figure 2-9).
- Tighten the telescope mounting screw on the CG-5 mount to hold the telescope in place.
- Hand tighten the mounting platform safety screw until the tip touches the side of the mounting bracket.

NOTE: Never loosen any of the knobs on the telescope tube or mount. Also, be sure that the open end of the telescope is pointing away from the ground at all times.

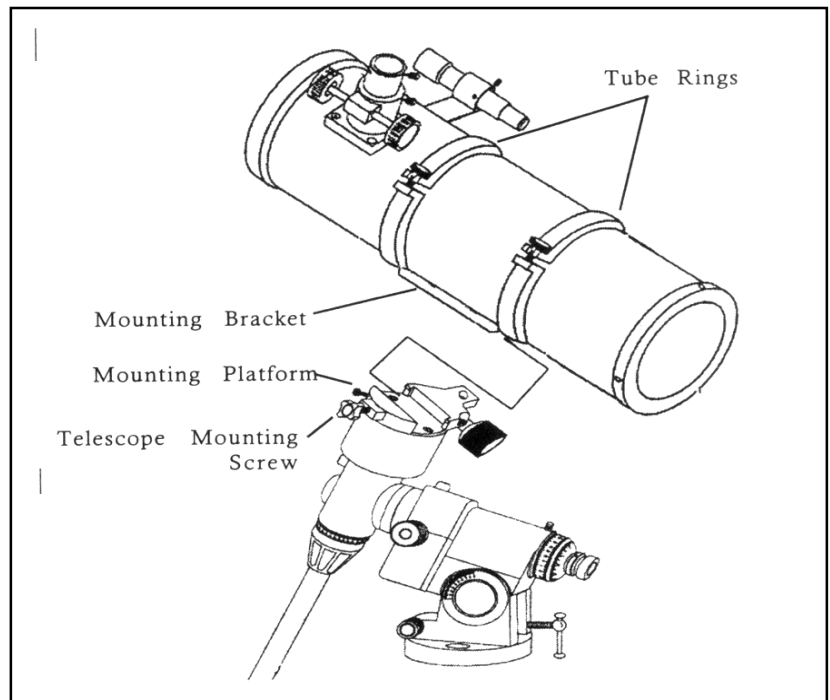

Figure 2-9

Installing the Finderscope

To install the finderscope onto the telescope you must first mount the finderscope through the finder bracket and then attach it to the telescope. Toward the front of the telescope tube, near the focusing assembly, there is a small bracket with a set screw in it. This is where the finderscope bracket will be mounted. To install the finderscope:

1. Slide the rubber O-ring over the eyepiece end of the finderscope and roll it 2/3 of the way up the finderscope.
2. Insert the eyepiece end of the finderscope through the bracket until the O-ring presses tightly between the finder and the inside of the bracket.
3. Tighten the adjustment screws until they make contact with the finderscope body.
4. Locate the mounting bracket near the front (open) end of the telescope.

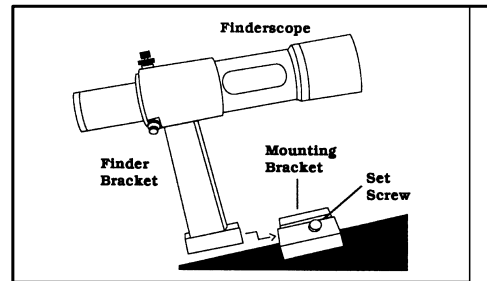

Figure 2-10

5. Loosen the set screw on the mounting bracket on the telescope.
6. Slide the finder bracket (attached to the finderscope) into the mounting bracket on the telescope.
7. The finderscope bracket will slide in from the back. The finderscope should be oriented so that the objective lens is toward the front (open) end of the telescope.
8. Tighten the set screw on the mounting bracket to hold the finderscope in place.

For information on aligning your finderscope, see *Telescope Basics* section of this manual.

Installing the Eyepieces

The eyepiece, or ocular as it is also called, is an optical element that magnifies the image focused by the telescope. Without the eyepiece it would be impossible to use the telescope visually. The eyepiece fits directly into the eyepiece holder. To attach an ocular:

1. Loosen the set screw on the eyepiece holder so that it does not obstruct the inner diameter of the eyepiece holder.
2. Slide the chrome portion of the eyepiece into the eyepiece holder.
3. Tighten the set screw to hold the eyepiece in place.

To remove the eyepiece, loosen the set screw on the eyepiece holder and slide

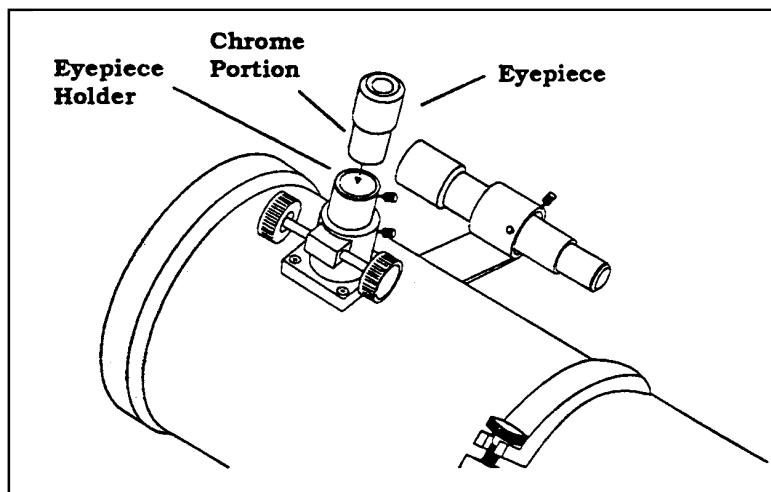

Figure 2-11

the eyepiece out. You can replace it with another ocular.

Eyepieces are commonly referred to by focal length which is printed on the eyepiece barrel. The longer the focal length (i.e., the larger the number) the lower the eyepiece power and the shorter the focal length (i.e., the smaller the number) the higher the magnification. Generally, you will use low-to-moderate power when viewing.

Your telescope can use eyepieces with both a 1-1/4" barrel diameter and 2" barrel diameter. To use a 2" barrel eyepiece, the 1 1/4" eyepiece adapter must first be removed and replaced with the included 2" eyepiece adapter. To do this, simply loosen the two chrome thumbscrews located around the focuser barrel (see figure 2-12) and remove the 1 1/4" adapter. Once removed, a 2" eyepiece adapter can be inserted directly into the focuser barrel and secured with the two thumb screws.

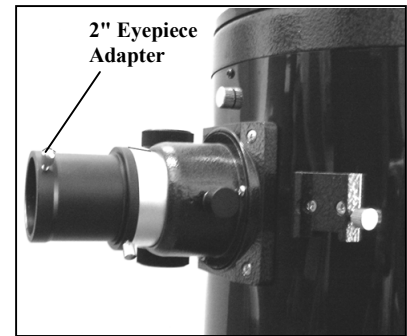

Figure 2-12

Balancing the Tube in R.A.

To eliminate undue stress on the mount, the telescope should be properly balanced around the polar axis. In addition, proper balancing is crucial for accurate tracking if using an optional motor drive. To balance the mount:

1. Release the R.A. Clamp (figure 2-16) and position the telescope off to one side of the mount (make sure that the mounting bracket screw is tight). The counterweight bar will extend horizontally on the opposite side of the mount (see figure 2-13).
2. Release the telescope — **GRADUALLY** — to see which way the telescope “rolls.”
3. Loosen the set screw on the counterweight.
4. Move the counterweight to a point where it balances the telescope (i.e., it remains stationary when the R.A. clamp is released).
5. Tighten the set screw to hold the counterweight(s) in place.

These are general balance instructions and will reduce undue stress on the mount. When taking astrophotographs, this balance process should be done for the specific area at which the telescope is pointing.

Balancing the Telescope in DEC

The telescope should also be balanced on the declination axis to prevent any sudden motions when the DEC clamp (figure 2-16) is released. To balance the telescope in DEC:

1. Release the R.A. clamp and rotate the telescope so that it is on one side of the mount (i.e., as described in the previous section on balancing the telescope in R.A.).
2. Lock the R.A. clamp to hold the telescope in place.
3. Release the DEC clamp and rotate the telescope until the tube is parallel to the ground (see figure 2-14).
4. Release the tube — **GRADUALLY** — to see which way it rotates around the declination axis. **DO NOT LET GO OF THE TELESCOPE TUBE COMPLETELY!**

5. Loosen the screws that hold the telescope tube inside the mounting rings and slide the telescope either forwards or backwards until it remains stationary when the DEC clamp is released.
6. Tighten the tube ring screws firmly to hold the telescope in place.

Like the R.A. balance, these are general balance instructions and will reduce undue stress on the mount. When taking astrophotographs, this balance process should be done for the specific area at which the telescope is pointing.

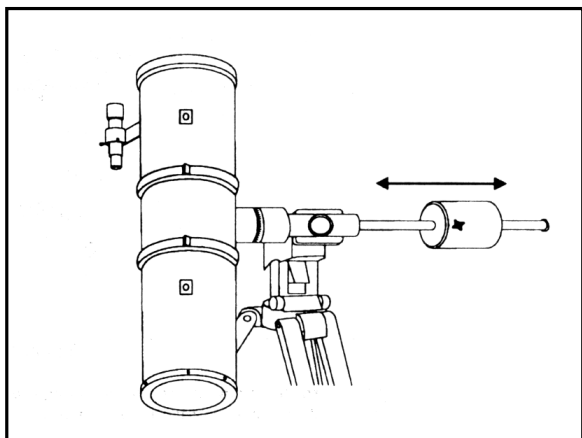

Figure 2-13

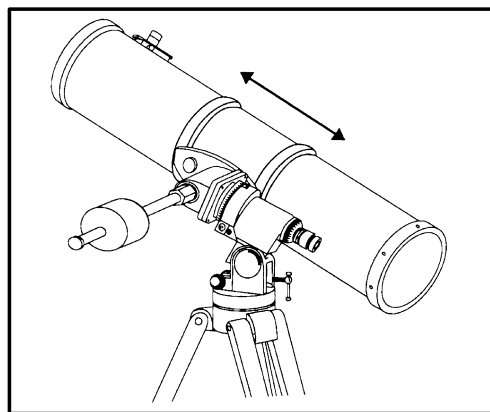

Figure 2-14

Adjusting the Mount

In order for a motor drive to track accurately, the telescope's axis of rotation must be parallel to the Earth's axis of rotation, a process known as polar alignment. Polar alignment is achieved NOT by moving the telescope in R.A. or DEC, but by adjusting the mount vertically, which is called altitude, and horizontally, which is called azimuth. This section simply covers the correct movement of the telescope during the polar alignment process. The actual process of polar alignment, that is making the telescope's axis of rotation parallel to the Earth's, is described later in this manual in the section on "Polar Alignment."

Adjusting the Mount in Altitude

- To increase the latitude of the polar axis, tighten the rear latitude adjustment screw and loosen the front screw (if necessary).
- To decrease the latitude of the polar axis, tighten the front (under the counterweight bar) latitude adjustment screw and loosen the rear screw (if necessary).

The latitude adjustment on the CG-5 mount has a range from approximately 30° going up to 60°.

It is best to always make final adjustments in altitude by moving the mount against gravity (i.e. using the rear latitude adjustment screw to raise the mount). To do this you should loosen both latitude adjustment screws and manually push the front of the mount down as far as it will go. Then tighten the rear adjustment screw to raise the mount to the desired latitude.

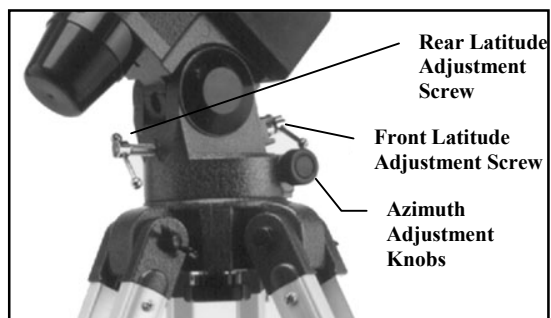

Figure 2-15

For Advanced GT users, it may be helpful to remove the front latitude adjustment screw completely. This will allow the mount to reach lower latitudes without the screw coming into contact with the R.A. motor assembly. To remove the latitude screw, first use the rear screw to raise the mount head all the way up. Then remove the front latitude screw completely. Now you should be able to manually move the mount head all the way to its lowest latitude. Now, using only the rear screw, raise the mount to your desired latitude.

Adjusting the Mount in Azimuth

For rough adjustments in azimuth, simply pick up the telescope and tripod and move it. For fine adjustments in azimuth:

1. Turn the azimuth adjustment knobs located on either side of the azimuth housing (see Fig 2-15). While standing behind the telescope, the knobs are on the front of the mount.
 - Turning the right adjustment knob clockwise moves the mount toward the right.
 - Turning the left adjustment knob clockwise moves the mount to the left.

Both screws push off of the peg on the tripod head, which means you may have to loosen one screw while tightening the other. The screw that holds the equatorial mount to the tripod may have to be loosened slightly.

Keep in mind that adjusting the mount is done during the polar alignment process only. Once polar aligned, the mount must NOT be moved. Pointing the telescope is done by moving the mount in right ascension and declination, as described earlier in this manual.

Attaching the Declination Cable (For GT Models Only)

The Advanced Series mount comes with a declination cable that connects from the R.A. motor drive electronic panel to the Dec motor drive. To attach the motor cable:

Locate the Declination cable and plug one end of the cable into the port on the electronics panel labeled *DEC Port* and plug the other end of the cable into the port located on the declination motor drive (see Fig 2-16).

Powering the Telescope

The Advanced GT can be powered by the supplied car battery adapter or optional 12v AC adapter. Use only adapters supplied by Celestron. Using any other adapter may damage the electronics or cause the telescope not to operate properly, and will void your manufacturer's warranty.

1. To power the telescope with the car battery adapter (or 12v AC adapter), simply plug the round post into the 12v outlet on the electronic panel and plug the other end into your cars cigarette lighter outlet or portable power supply (see *Optional Accessories*). Note: to prevent the power cord from being accidentally pulled out, wrap the power cord around the strain relief located below the power switch.
2. Turn on the power to the telescope by flipping the switch, located on the electronics panel, to the "On" position.

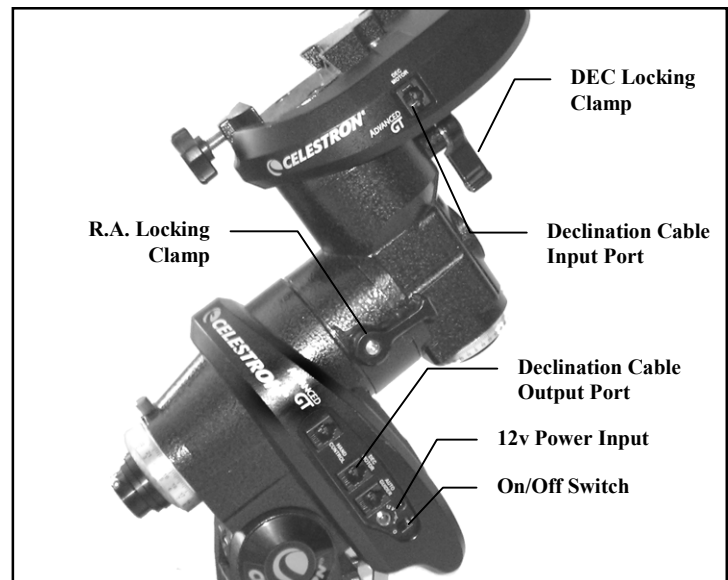

Figure 2-16

CELESTRON Hand Control

The Advanced Series GT, computerized version of each telescope has a hand controller designed to give you instant access to all the functions that your telescope has to offer. With automatic slewing to over 40,000 objects, and common sense menu descriptions, even a beginner can master its variety of features in just a few observing sessions. Below is a brief description of the individual components of the computerized hand controller:

1. **Liquid Crystal Display (LCD) Window:** Has a dual-line, 16 character display screen that is backlit for comfortable viewing of telescope information and scrolling text.
2. **Align:** Instructs the telescope to use a selected star or object as an alignment position.
3. **Direction Keys:** Allows complete control of the telescope in any direction. Use the direction keys to move the telescope to the initial alignment stars or for centering objects in the eyepiece.

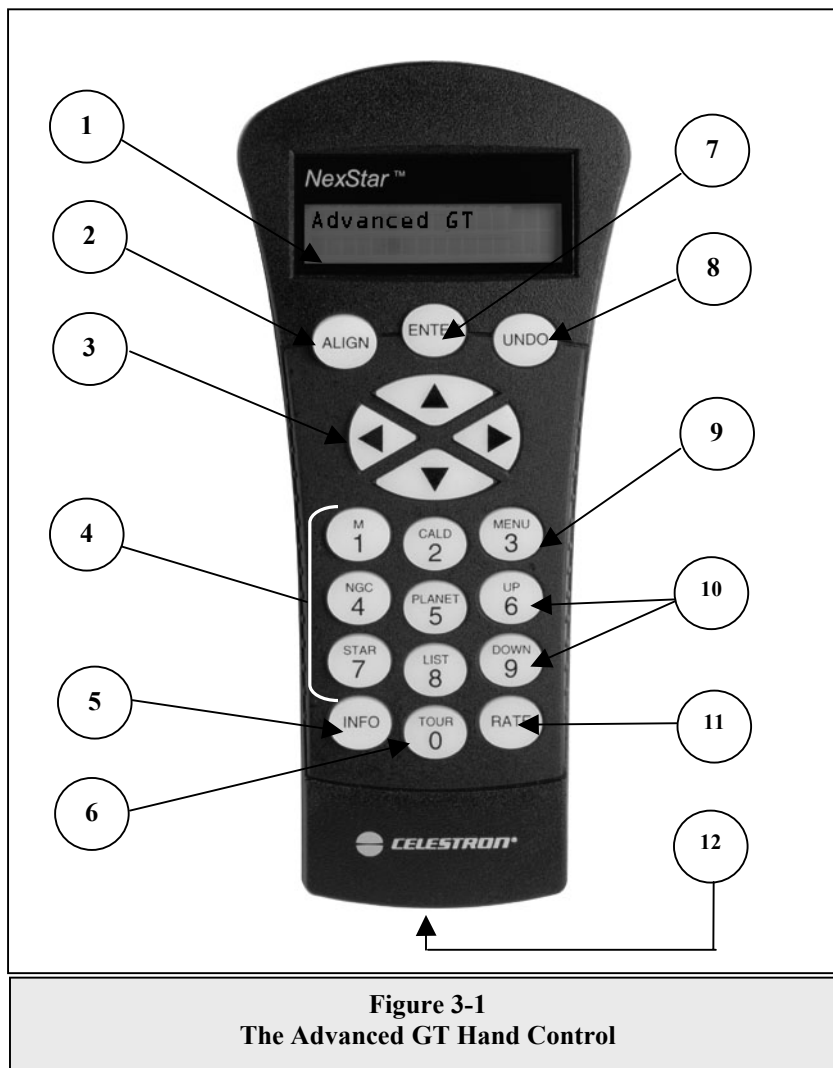

Figure 3-1
The Advanced GT Hand Control

4. **Catalog Keys:** The Advanced Series has keys on the hand control to allow direct access to each of the catalogs in its database. The hand control contains the following catalogs in its database:

Messier – Complete list of all Messier objects.

NGC – Complete list of all the deep-sky objects in the Revised New General Catalog.

Caldwell – A combination of the best NGC and IC objects.

Planets - All 8 planets in our Solar System plus the Moon.

Stars – A compiled list of the brightest stars from the SAO catalog.

List – For quick access, all of the best and most popular objects in the Advanced GT database have been broken down into lists based on their type and/or common name:

Named Stars	Common name listing of the brightest stars in the sky.
Named Objects	Alphabetical listing of over 50 of the most popular deep sky objects.
Double Stars	Numeric-alphabetical listing of the most visually stunning double, triple and quadruple stars in the sky.
Variable Stars	Select list of the brightest variable stars with the shortest period of changing magnitude.
Asterisms	A unique list of some of the most recognizable star patterns in the sky.
CCD Objects	A custom list of many interesting galaxy pairs, trios and clusters that are well suited for CCD imaging with the Advanced GT telescope.
IC Objects	A complete list of all the Index Catalog deep-sky objects.
Abell Objects	A custom list of the Abell Catalog deep-sky galaxies.
Constellation	A complete list of all 88 constellations.

5. **Info:** Displays coordinates and useful information about objects selected from the Advanced GT database.
6. **Tour:** Activates the tour mode, which seeks out all the best objects for the current date and time, and automatically slews the telescope to those objects.
7. **Enter:** Pressing *Enter* allows you to select any of the Advanced GT functions and accept entered parameters.
8. **Undo:** *Undo* will take you out of the current menu and display the previous level of the menu path. Press *Undo* repeatedly to get back to a main menu or use it to erase data entered by mistake.
9. **Menu:** Displays the many setup and utilities functions such as tracking rates and user defined objects and many others.
10. **Scroll Keys:** Used to scroll up and down within any of the menu lists. A double-arrow will appear on the right side of the LCD when there are sub-menus below the displayed menu. Using these keys will scroll through those sub-menus.
11. **Rate:** Instantly changes the rate of speed of the motors when the direction buttons are pressed.
12. **RS-232 Jack:** Allows you to interface with a computer and control the telescope remotely.

Hand Control Operation

This section describes the basic hand control procedures needed to operate the GT Series Telescopes. These procedures are grouped into three categories: Alignment, Setup and Utilities. The alignment section deals with the initial telescope alignment as well as finding objects in the sky; the setup section discusses changing parameters such as tracking mode and tracking rate; finally, the last section reviews all of the utilities functions such as calibrating your mount, polar alignment and backlash compensation.

Alignment Procedures

In order for the telescope to accurately point to objects in the sky, it must first be aligned to three known positions (stars) in the sky. With this information, the telescope can create a model of the sky, which it uses to locate any object with known coordinates. There are many ways to align your telescope with the sky depending on what information the user is able to provide: **Auto Align** allows the telescope to select three stars and uses the entered time/location information to align the telescope; **Auto Three Star Align** involves the same process as *Auto Align*, however it allows the user to select which star to use to align the telescope. **Quick-Align** will ask you to input all the same information as you would for the Auto Align procedure. However, instead of slewing to the alignment stars for centering and alignment, the telescope bypasses this step and simply models the sky based on the information given. Finally, **Last Alignment** restores your last saved star alignment and switch position. Last Alignment also serves as a good safeguard in case the telescope should lose power.

Startup Procedure

Before any of the described alignments are performed, the telescope mount needs to be positioned so that the index marks are aligned on both the right ascension and declination axes (see Fig 2-8).

First index its switch position so that each axis has an equal amount of travel to move in either direction. Once the index position has been set, the hand control will display the last entered date and time information stored in the hand control. Once the telescope is powered on:

1. Press ENTER begin the alignment process.
2. The hand control will ask the user to set the mount to its index position. Move the telescope mount, either manually or with the hand control, so that the index marked in both R.A. and Dec are aligned (see Fig 2-8). Press *Enter* to continue.
3. The hand control will then display the last entered local time, date, time zone, longitude and latitude.
 - Use the Up/Down keys (10) to view the current parameters.
 - Press ENTER to accept the current parameters.
 - Press UNDO to enter current date and time information into the hand control. The following information will be displayed:

Time - Enter the current local time for your area. You can enter either the local time (i.e. 08:00), or you can enter military time (i.e. 20:00).

- Select PM or AM. If military time was entered, the hand control will bypass this step.
- Choose between Standard time or Daylight Savings time. Use the Up and Down scroll buttons (10) to toggle between options.
- Select the time zone that you are observing from. Again, use the Up and Down buttons (10) to scroll through the choices. Refer to Time Zone map in Appendix for more information.

Date - Enter the month, day and year of your observing session.

- Finally, you must enter the longitude and latitude of the location of your observing site. Use the table in Appendix C to locate the closest longitude and latitude for your current observing location and enter those numbers when asked in the hand control, pressing ENTER after each entry. Remember to select "West" for longitudes in North America and "North" for latitudes in the North Hemisphere. For international cities, the correct hemisphere is indicated in the Appendix listings.

4. Select one of the four alignment methods as described below.

Mount Calibration

After an Auto Align is successfully completed, the hand control will display the message, Calibrating...

This automatic calibration routine is necessary to calculate and compensates for "cone" error inherent in all German equatorial mounts. Cone error is the inaccuracy that results from the optical tube not being exactly perpendicular to the mounts declination axis as well as various other inaccuracies such as backlash in the mounts gears. The telescope is able to automatically determine the cone error value by always using alignment stars on both sides of the Meridian (see Figure 3-2). Mechanical errors can be reduced further by always centering alignment stars using the up and right arrow buttons as described in the Pointing Accuracy box below.

Note: If incorrect information is entered into the hand control, the UNDO button acts like a back space button allowing the user to re-enter the correct data.

Auto Align

Auto Align allows the telescope to automatically choose three stars (two on one side of the Meridian, and one on the opposite side) on which to align itself. To Auto Align your telescope:

1. Select Auto Align from the alignment choices given. Based on the date and time information entered, the telescope will automatically select and go to a bright star that is above the horizon.
 - If for some reason the chosen star is not visible (perhaps behind a tree or building) press UNDO to automatically select the next bright star from the database star list.
2. Once the telescope is finished slewing to your first alignment star, the display will ask you to use the arrow buttons to align the selected star with the crosshairs in the center of the finderscope. Once centered in the finder, press ENTER.
3. The display will then instruct you to center the star in the field of view of the eyepiece. When the star is centered, press ALIGN to accept this star as your first alignment star.
4. After the first alignment star has been entered the telescope will automatically select a second alignment star on the same side of the Meridian and have you repeat this procedure for that star.
5. For the third alignment star, the telescope will select a bright star on the opposite side of the Meridian and slew to it. Once again center the star in the crosshairs of the finderscope and then center the star in the eyepiece, pressing ENTER when complete.

When the telescope has been aligned on all three stars the display will read Alignment Successful, and you are now ready to find your first object.

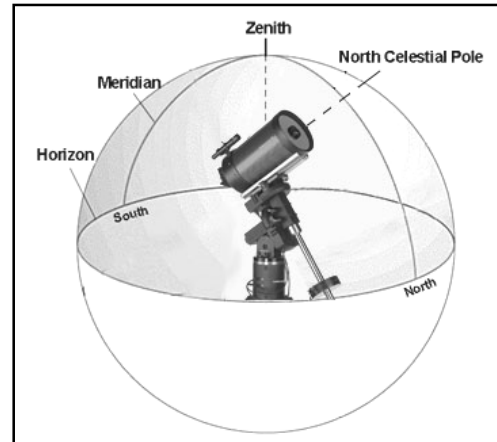

Figure 3-2

The Meridian is an imaginary line in the sky that starts at the North celestial pole and ends at the South celestial pole and passes through the zenith. If you are facing South, the meridian starts from your Southern horizon and passes directly overhead to the North celestial pole.

Auto Three-Star Align

Auto Three-Star Alignment works much the same way as Auto Align, however instead of automatically slewing to the alignment stars, the user is allowed to select the alignment stars from a list. To use *Auto Three-Star Align*:

1. Select Auto Three Star Align from the alignment choices given.
2. The hand control will display a recommended alignment star to begin.
 - Press UNDO to display the next recommended star on the same side of the Meridian, or
 - Press the UP and DOWN arrows keys to scroll through the complete list of available alignment stars to choose from.
3. Once the desired alignment star is displayed on the hand control press ENTER to slew the telescope to the star.
4. As with the Auto Align procedure, you will be asked to center the star in the crosshairs of the finderscope and then center the star in the eyepiece, pressing ENTER when complete.

Pointing Accuracy

For the best possible pointing accuracy, always center the alignment stars using the up arrow button and the right arrow button. Approaching from this direction when looking through the eyepiece will eliminate much of the backlash between the gears and assures the most accurate alignment possible.

NOTE: Although the telescope allows the user to select the alignment stars, for best all-sky pointing accuracy it is still necessary to select two alignment stars on one side of the Meridian and the third star on the opposite side of the Meridian. For this reason, the hand control will only display stars that are on the same side of the Meridian for the first two alignment stars, then will only display stars on the opposite side of the Meridian for the third alignment star.

Quick-Align

Quick-Align uses all the date and time information entered at startup to align the telescope. However, instead of slewing to the alignment stars for centering and alignment, the telescope bypasses this step and simply models the sky based on the information given. This will allow you to roughly slew to the coordinates of bright objects like the moon and planets and gives the telescope the information needed to track objects in any part of the sky (depending on accuracy of polar alignment). Quick-Align is not meant to be used to accurately locate small or faint deep-sky objects or to track objects accurately for photography.

To use Quick-Align, simply select Quick Align from the alignment options and press ENTER. The telescope will automatically use the entered date/time parameters to align itself with the sky and display *Alignment Successful*.

NOTE: Once a Quick-Align has been done, you can use the Re-alignment feature (see below) to improve your telescopes pointing accuracy.

Last Alignment

The *Last Alignment* method will automatically recall the last stored index positions to continue using the alignment that was saved when the telescope was last powered down. This is a useful feature should your telescope accidentally lose power or be powered down.

NOTE: Just like with Quick-Align, you can use the Re-alignment feature (see below) to improve your telescopes pointing accuracy after using the *Last Alignment* method. To maintain a more accurate alignment over a series of observing sessions, use the *Hibernate* feature described later in this chapter.

Re-Alignment

The Advanced Series telescopes have a re-alignment feature which allows you to replace any of the original alignment stars with a new star or celestial object. This can be useful in several situations:

- If you are observing over a period of a few hours, you may notice that your original two alignment stars have drifted towards the west considerably. (Remember that the stars are moving at a rate of 15° every hour). Aligning on a new star that is in the eastern part of the sky will improve your pointing accuracy, especially on objects in that part of the sky.
- If you have aligned your telescope using the Quick-Align method, you can use *re-align* to align on actual objects in the sky. This will improve the pointing accuracy of your telescope without having to re-enter additional information.

To replace an existing alignment star with a new alignment star:

1. Select the desired star (or object) from the database and slew to it.
2. Carefully center the object in the eyepiece.
3. Once centered, press the UNDO button until you are at the main menu.
4. With Advanced GT displayed, press the ALIGN key on the hand control.
5. The display will then ask you which alignment star you want to replace. Use the UP and Down scroll keys to select the alignment star to be replaced. It is usually best to replace the star closest to the new object. This will space out your alignment stars across the sky.
6. Press ALIGN to make the change.

Object Catalog

Selecting an Object

Now that the telescope is properly aligned, you can choose an object from any of the catalogs in the telescope's extensive database. The hand control has a key (4) designated for each of the catalogs in its database. There are two ways to select objects from the database: scrolling through the named object lists and entering object numbers.



**Helpful
Hint**

Pressing the LIST key on the hand control will access all objects in the database that have common names or types. Each list is broken down into the following categories: Named Stars, Named Object, Double Stars, Variable Stars, Asterisms and CCD Objects. Selecting any one of these catalogs will display a numeric-alphabetical listing of the objects under that list. Pressing the Up and Down keys (10) allows you to scroll through the catalog to the desired object.

When scrolling through a long list of objects, holding down either the Up or Down key will allow you to scroll through the catalog more rapidly by only displaying every fifth catalog object.

Pressing any of the other catalog keys (M, CALD, NGC, or STAR) will display a blinking cursor below the name of the catalog chosen. Use the numeric key pad to enter the number of any object within these standardized catalogs. For example, to find the Orion Nebula, press the "M" key and enter "042".

Slewing to an Object

Once the desired object is displayed on the hand control screen, choose from the following options:

- **Press the INFO Key.** This will give you useful information about the selected object such as R.A. and declination, magnitude size and text information for many of the most popular objects.
- **Press the ENTER Key.** This will automatically slew the telescope to the coordinates of the object.

Caution: Never slew the telescope when someone is looking into the eyepiece. The telescope can move at fast slew speeds and may hit an observer in the eye.

Object information can be obtained without having to do a star alignment. After the telescope is powered on, pressing any of the catalog keys allows you to scroll through object lists or enter catalog numbers and view the information about the object as described above.

Finding Planets

Your telescope can locate all 8 of our solar systems planets plus the Moon. However, the hand control will only display the solar system objects that are above the horizon (or within its filter limits). To locate the planets, press the PLANET key on the hand control. The hand control will display all solar system objects that are above the horizon:

- Use the **Up and Down** keys to select the planet that you wish to observe.
- Press **INFO** to access information on the displayed planet.
- Press **ENTER** to slew to the displayed planet.

Tour Mode

The Advanced Series telescopes include a tour feature which automatically allows the user to choose from a list of interesting objects based on the date and time in which you are observing. The automatic tour will display only those objects that are within your set filter limits (see *Filter Limits* in the *Setup Procedures* section of the manual). To activate the Tour mode, press the TOUR key (6) on the hand control. The hand control will display the best objects to observe that are currently in the sky.

- To see information and data about the displayed object, press the INFO key.
- To slew to the object displayed, press ENTER.
- To see the next tour object, press the Up key.

Constellation Tour

In addition to the Tour Mode, your telescope has a Constellation Tour that allows the user to take a tour of all the best objects in each of the 88 constellations. Selecting *Constellation* from the LIST menu will display all the constellation names that are above the user defined horizon (filter limits). Once a constellation is selected, you can choose from any of the database object catalogs to produce a list of all the available objects in that constellation.

- To see information and data about the displayed object, press the INFO key.
- To slew to the object displayed, press ENTER.
- To see the next tour object, press the Up key.

Direction Buttons

The hand control has four direction buttons (3) in the center of the hand control which control the telescope's motion in altitude (up and down) and azimuth (left and right). The telescope can be controlled at nine different speed rates.

Rate Button

Pressing the RATE key (11) allows you to instantly change the speed rate of the motors from high speed slew rate to precise guiding rate or anywhere in between. Each rate corresponds to a number on the hand controller key pad. The number 9 is the fastest rate (3° per second, depending on power source) and is used for slewing between objects and locating alignment stars. The number 1 on the hand control is the slowest rate (.5x sidereal) and can be used for accurate centering of objects in the eyepiece and photographic guiding. To change the speed rate of the motors:

- Press the RATE key on the hand control. The LCD will display the current speed rate.
- Press the number on the hand control that corresponds to the desired speed. The number will appear in the upper-right corner of the LCD display to indicate that the rate has been changed.

The hand control has a "double button" feature that allows you to instantly speed up the motors without having to choose a speed rate. To use this feature, simply press the arrow button that corresponds to the direction that you want to move the telescope. While holding that button down, press the opposite directional button. This will increase the slew rate to the maximum slew rate.

The direction that a star moves in the eyepiece when a direction is pressed will change depending on which side of the Meridian the telescope tube is positioned. In order to change the direction of the arrow buttons, see *Scope Setup Features* later in this section.

<i>1 = .5x</i>	<i>6 = 64x</i>
<i>2 = 1x (sidereal)</i>	<i>7 = .5°/sec</i>
<i>3 = 4x</i>	<i>8 = 2°/sec</i>
<i>4 = 8x</i>	<i>9 = 3°/sec</i>
<i>5 = 16x</i>	
Nine available slew speeds	

Setup Procedures

The Advanced GT contains many user defined setup functions designed to give the user control over the telescope's many advanced features. All of the setup and utility features can be accessed by pressing the MENU key and scrolling through the options:

Tracking Mode This allows you to change the way the telescope tracks depending on the type of mount being used to support the telescope. The telescope has three different tracking modes:

EQ North Used to track the sky when the telescope is polar aligned in the Northern Hemisphere.

EQ South Used to track the sky when the telescope is polar aligned in the Southern Hemisphere.

Off When using the telescope for terrestrial (land) observation, the tracking can be turned off so that the telescope never moves.

Tracking Rate In addition to being able to move the telescope with the hand control buttons, your telescope will continually track a celestial object as it moves across the night sky. The tracking rate can be changed depending on what type of object is being observed:

Sidereal This rate compensates for the rotation of the Earth by moving the telescope at the same rate as the rotation of the Earth, but in the opposite direction. When the telescope is polar aligned, this can be accomplished by moving the telescope in right ascension only.

Lunar Used for tracking the moon when observing the lunar landscape.

Solar Used for tracking the Sun when solar observing with the proper filter.

View Time-Site - Displays the current time and longitude/latitude downloaded from the optional CN-16 GPS receiver. It will also display other relevant time-site information like time zone, daylight saving and local sidereal time. Local sidereal time (LST) is useful for knowing the right ascension of celestial objects that are located on the Meridian at that time. *View Time-Site* will always display the last saved time and location entered while it is linking with the GPS. Once current information has been received, it will update the displayed information. If GPS is switched off or not present, the hand control will only display the last saved time and location.

User Defined Objects - Your telescope can store up to 400 different user defined objects in its memory. The objects can be daytime land objects or an interesting celestial object that you discover

that is not included in the regular database. There are several ways to save an object to memory depending on what type of object it is:

- GoTo Object:** To go to any of the user defined objects stored in the database, scroll down to either `GoTo Sky Obj` or `GoTo Land Obj` and enter the number of the object you wish to select and press ENTER. The telescope will automatically retrieve and display the coordinates before slewing to the object.
- Save Sky Object:** Your telescope stores celestial objects to its database by saving its right ascension and declination in the sky. This way the same object can be found each time the telescope is aligned. Once a desired object is centered in the eyepiece, simply scroll to the "`Save Sky Obj`" command and press ENTER. The display will ask you to enter a number between 1-200 to identify the object. Press ENTER again to save this object to the database.
- Enter R.A. - Dec:** You can also store a specific set of coordinates for an object just by entering the R.A. and declination for that object. Scroll to the "`Enter RA-DEC`" command and press ENTER. The display will then ask you to enter first the R.A. and then the declination of the desired object.
- Save Land Object:** The telescope can also be used as a spotting scope on terrestrial objects. Fixed land objects can be stored by saving their altitude and azimuth relative to the location of the telescope at the time of observing. Since these objects are relative to the location of the telescope, they are only valid for that exact location. To save land objects, once again center the desired object in the eyepiece. Scroll down to the "`Save Land Obj`" command and press ENTER. The display will ask you to enter a number between 1-200 to identify the object. Press ENTER again to save this object to the database.

To replace the contents of any of the user defined objects, simply save a new object using one of the existing identification numbers; the telescope will replace the previous user defined object with the current one.

Get RA/DEC - Displays the right ascension and declination for the current position of the telescope.

Goto R.A/ Dec - Allows you to input a specific R.A. and declination and slew to it.



**Helpful
Hint**

To store a set of coordinates (R.A./Dec) permanently into the database, save it as a *User Defined Object* as described above.

Identify

Identify Mode will search any of the telescope's database catalogs or lists and display the name and offset distances to the nearest matching objects. This feature can serve two purposes. First, it can be used to identify an unknown object in the field of view of your eyepiece. Additionally, *Identify Mode* can be used to find other celestial objects that are close to the objects you are currently observing. For example, if your telescope is pointed at the brightest star in the constellation Lyra, choosing *Identify* and then searching the *Named Star* catalog will no doubt return the star Vega as the star you are observing. However, by selecting *Identify* and searching by the *Named Object* or *Messier* catalogs, the hand control will let you know that the Ring Nebula (M57) is approximately 6° from your current position. Searching the Double Star catalog will reveal that Epsilon Lyrae is only 1° away from Vega. To use the *Identify* feature:

- Press the Menu button and select the Identify option.
- Use the Up/Down scroll keys to select the catalog that you would like to search.
- Press ENTER to begin the search.

Note: Some of the databases contain thousands of objects, and can therefore take several minutes to return the closest objects.

Precise GoTo

The Advanced Series telescopes have a precise goto function that can assist in finding extremely faint objects and centering objects closer to the center of the field of view for astrophotography and CCD imaging. Precise Goto automatically searches out the closest bright star to the desired object and asks the user to carefully center it in the eyepiece. The hand control then calculates the small difference between its goto position and its centered position. Using this offset, the telescope will then slew to the desired object with enhanced accuracy. To use Precise Goto:

1. Press the MENU button and use the Up/Down keys to select *Precise Goto*.
 - Choose *Database* to select the object that you want to observe from any of the database catalogs listed or;
 - Choose *RA/DEC* to enter a set of celestial coordinates that you wish to slew to.
2. Once the desired object is selected, the hand control will search out and display the closest bright star to your desired object. Press ENTER to slew to the bright alignment star.
3. Use the direction buttons to carefully center the alignment star in the eyepiece.
4. Press ENTER to slew to the desired object.

Scope Setup Features

Setup Time-Site - Allows the user to customize the telescope's display by changing time and location parameters (such as time zone and daylight savings).

Anti-backlash - All mechanical gears have a certain amount of backlash or play between the gears. This play is evident by how long it takes for a star to move in the eyepiece when the hand control arrow buttons are pressed (especially when changing directions). The Advanced GT's anti-backlash features allows the user to compensate for backlash by inputting a value which quickly rewinds the motors just enough to eliminate the play between gears. The amount of compensation needed depends on the slewing rate selected; the slower the slewing rate the longer it will take for the star to appear to move in the eyepiece. There are two values for each axis, positive and negative. Positive is the amount of compensation applied when you press the button, in order to get the gears moving quickly without a long pause. Negative is the amount of compensation applied when you release the button, winding the motors back in the other direction to resume tracking. Normally both values should be the same. You will need to experiment with different values (from 0-99); a value between 20 and 50 is usually best for most visual observing, whereas a higher value may be necessary for photographic guiding.

To set the anti-backlash value, scroll down to the *anti-backlash* option and press ENTER. While viewing an object in the eyepiece, observe the responsiveness of each of the four arrow buttons. Note which directions you see a pause in the star movement after the button has been pressed. Working one axis at a time, adjust the backlash settings high enough to cause immediate movement without resulting in a pronounced jump when pressing or releasing the button. Now, enter the same values for both positive and negative directions. If you notice a jump when releasing the button, but setting the values lower results in a pause when pressing the button, go with the higher value for positive, but use a lower value for negative. The telescope will remember these values and use them each time it is turned on until they are changed.

Filter Limits - When an alignment is complete, the telescope automatically knows which celestial objects are above the horizon. As a result, when scrolling through the database lists (or selecting the Tour function), the hand control will display only those objects that are known to be above the horizon when you are observing. You can customize the object database by selecting altitude limits that are appropriate for your location and situation. For

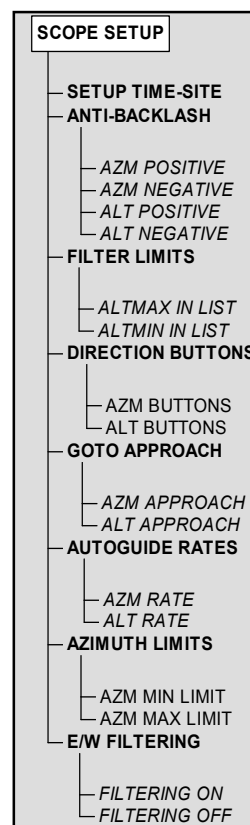

example, if you are observing from a mountainous location where the horizon is partially obscured, you can set your minimum altitude limit to read +20°. This will make sure that the hand control only displays objects that are higher in altitude than 20°.

Observing Tip!

If you want to explore the entire object database, set the maximum altitude limit to 90° and the minimum limit to -90°. This will display every object in the database lists regardless of whether it is visible in the sky from your location.

Direction Buttons –The direction a star appears to move in the eyepiece changes depending on which side of the Meridian the telescope tube is on. This can create confusion especially when guiding on a star when doing astrophotography. To compensate for this, the direction of the drive control keys can be changed. To reverse the button logic of the hand control, press the MENU button and select *Direction Buttons* from the Utilities menu. Use the Up/Down arrow keys (10) to select either the azimuth (right ascension) or altitude (declination) button direction and press ENTER. Select either positive or negative for both axes and press ENTER to save. Setting the azimuth button direction to positive will move the telescope in the same direction that the telescope tracks (i.e. towards the west). Setting the altitude buttons to positive will move the telescope counterclockwise along the DEC axis.

GoTo Approach - lets the user define the direction that the telescope will approach when slewing to an object. This allows the user the ability to minimize the affects of backlash when slewing from object to object. Just like with *Direction Buttons*, setting *GoTo Approach* to positive will make the telescope approach an object from the same direction as tracking (west) for azimuth and counterclockwise in declination. Declination GoTo approach will only apply while the telescope tube is on one side of the Meridian. Once the tube passes over to the other side of the Meridian, the GoTo approach will need to be reversed.

Helpful Hint!

To change the GoTo approach direction, simply choose *GoTo Approach* from the *Scope Setup* menu, select either Altitude or Azimuth approach, choose positive or negative and press ENTER.

In order to minimize the affect of gear backlash on pointing accuracy, the settings for *Button Direction* should ideally match the settings for *GoTo Approach*. By default, using the up and right direction buttons to center alignment stars will automatically eliminate much of the backlash in the gears. If you change the GoTo approach of your telescope it is not necessary to change the Button Direction as well. Simply take notice of the direction the telescope moves when completing it final goto approach. If the telescope approaches its alignment star from the west (negative azimuth) and clockwise (negative altitude) then make sure that the buttons used to center the alignment stars also move the telescope in the same directions.

Autoguide Rate – Allows the user to set an autoguide rate as a percentage of sidereal rate. This is helpful when calibrating your telescope to a CCD autoguider for long exposure photography.

Azimuth Limits - Sets the limits that the telescope can slew in azimuth (R.A.) The slew limits are set to 0° to 180°; with zero being the position of the telescope when the counterweight bar is extended out towards the west and 180° being the position when the counterweight bar is extended out toward the east (see Fig 3-3). However, the slew limits can be customized depending on your needs. For example, if you are using CCD imaging equipment that has cables that are not long enough to move with the telescope as it slews across the sky, you can adjust the azimuth slew limit on the side of the mount that is restricted by the cables. Using the example above, the user could slew the telescope

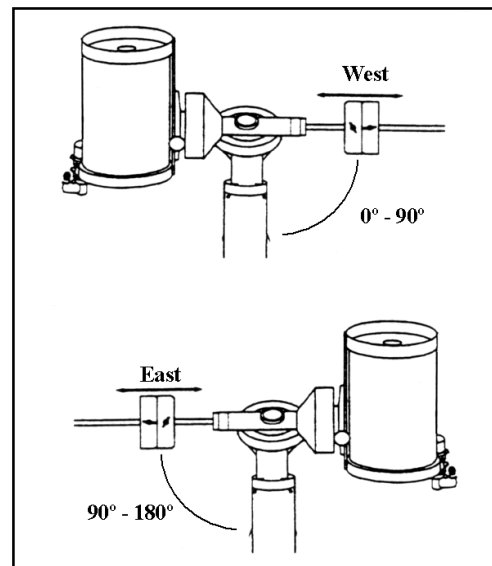

Fig 3-3 – Azimuth Slew Limits- This figure shows the full range of motion for the R.A. (azimuth) axis

in R.A. (azimuth) until it reaches the point that the cables are extended to their maximum. Then by displaying the telescopes azimuth in this position (by looking at *Get Alt-Az* under the *Utilities* menu) you can determine the telescopes azimuth at its most extended position. Enter this azimuth reading for either the maximum or minimum azimuth slew limit to ensure that the telescope will not slew beyond this point.

Warning: In order for the telescope to be able to slew to a star from the direction that minimizes the amount of backlash in the gears, it may be necessary for the telescope to slew beyond the specified slew limit in order to approach the star from the correct direction. This can limit your ability to slew to an object by as much as 6° from the azimuth slew limit set in the hand control. If this proves to be a problem, the direction that the telescope takes to center an object can be changed. To change the telescopes slewing direction, see *Goto Approach* under the *Scope Setup* menu. In order to guaranty that the telescope will have a full range of motion in R.A. (azimuth), set the azimuth slew limits to 354 and 186. This will allow the mount to slew without regard to the slew limits.

East/West (E/W) Filtering - In order to ensure the best possible full sky pointing accuracy, the Advanced series telescopes automatically filters and chooses its initial alignment stars so that the first two alignment stars are located on one side of the Meridian and the third star is on the opposite side of the Meridian. *East/West Filtering* allows you to turn off this automatic filtering feature, allowing the hand control to display all of its alignment stars when doing a *Auto Three Star Align*, without regard to the Meridian.

Utility Features

Scrolling through the MENU (9) options will also provide access to several advanced utility functions within the Advanced Series telescopes such as; Calibrate Goto, Polar Alignment, Hibernate as well as many others.

Calibrate Goto - Goto Calibration is a useful tool when attaching heavy visual or photographic accessories to the telescope. Goto Calibration calculates the amount of distance and time it takes for the mount to complete its final slow goto when slewing to an object. Changing the balance of the telescope can prolong the time it takes to complete the final slew. Goto Calibration takes into account any slight imbalances and changes the final goto distance to compensate.

Home Position – The telescopes "home" position is a user-definable position that is used to store the telescope when not in use. The home position is useful when storing the telescope in a permanent observatory facility. By default the Home position is the same as the index position used when aligning the mount. To set the *Home* position for your mount simply use the arrow buttons on the hand control to move the telescope mount to the desired position. Select the *Set* option and press Enter.

Polar Align- The Advanced GT has a polar alignment function that will help you polar align your telescope for increased tracking precision and astrophotography. After performing an Auto Alignment, the telescope will slew to where Polaris should be. By using the equatorial head to center Polaris in the eyepiece, the mount will then be pointed towards the actual North Celestial Pole. Once *Polar Align* is complete, you must re-align your telescope again using any of the alignment methods described earlier. To polar align the mount in the Northern Hemisphere:

1. With the telescope set up and roughly positioned towards Polaris, align the mount using the *Auto Align* or *Auto Three Star* method.
2. Select *Polar Align* from the *Utilities* menu and press Enter.

Based on your current alignment, the telescope will slew to where it thinks Polaris

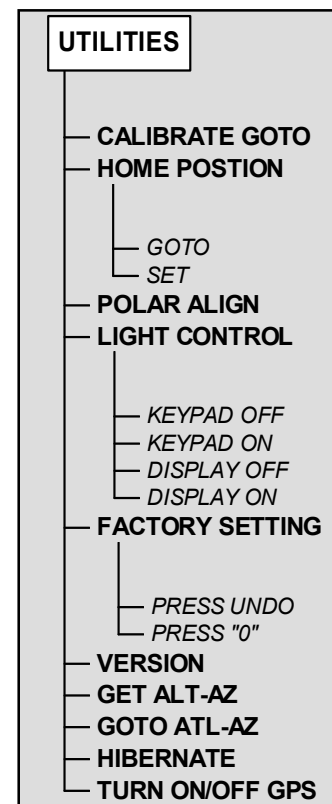

should be. Use the equatorial head latitude and azimuth adjustments to place Polaris in the center of the eyepiece. Do not use the direction buttons to position Polaris. Once Polaris is centered in the eyepiece press ENTER; the polar axis should then be pointed towards the North Celestial Pole.

Light Control – This feature allows you to turn off both the red key pad light and LCD display for daytime use to conserve power and to help preserve your night vision.

Factory Settings – Returns the Advanced GT hand control to its original factory settings. Parameters such as backlash compensation values, initial date and time, longitude/latitude along with slew and filter limits will be reset. However, stored parameters such as user defined objects will remain saved even when *Factory Settings* is selected. The hand control will ask you to press the "0" key before returning to the factory default setting.

Version - Selecting this option will allow you to see the current version number of the hand control, motor control and GPS software (if using optional CN-16 GPS accessory). The first set of numbers indicate the hand control software version. For the motor control, the hand control will display two sets of numbers; the first numbers are for azimuth and the second set are for altitude. On the second line of the LCD, the GPS and serial bus versions are displayed.

Get Alt-Az - Displays the relative altitude and azimuth for the current position of the telescope.

Goto Alt-Az - Allows you to enter a specific altitude and azimuth position and slew to it.

Hibernate - Hibernate allows the telescope to be completely powered down and still retain its alignment when turned back on. This not only saves power, but is ideal for those that have their telescopes permanently mounted or leave their telescope in one location for long periods of time. To place your telescope in Hibernate mode:

1. Select Hibernate from the Utility Menu.
2. Move the telescope to a desire position and press ENTER.
3. Power off the telescope. Remember to never move your telescope manually while in Hibernate mode.

Once the telescope is powered on again the display will read Wake Up. After pressing Enter you have the option of scrolling through the time/site information to confirm the current setting. Press ENTER to wake up the telescope.

**Helpful
Hint**

Pressing UNDO at the Wake Up screen allows you to explore many of the features of the hand control without waking the telescope up from hibernate mode. To wake up the telescope after UNDO has been pressed, select Hibernate from the Utility menu and press ENTER. Do not use the direction buttons to move the telescope while in hibernate mode.

Turn On/Off GPS - If using your Advanced GT telescope with the optional CN-16 GPS accessory (see *Optional Accessories* section of the manual), you will need to turn the GPS on the first time you use the accessory. . If you want to use the telescope's database to find the coordinates of a celestial object for a future or past dates you would need to turn the GPS off in order to manually enter a time other than the present.

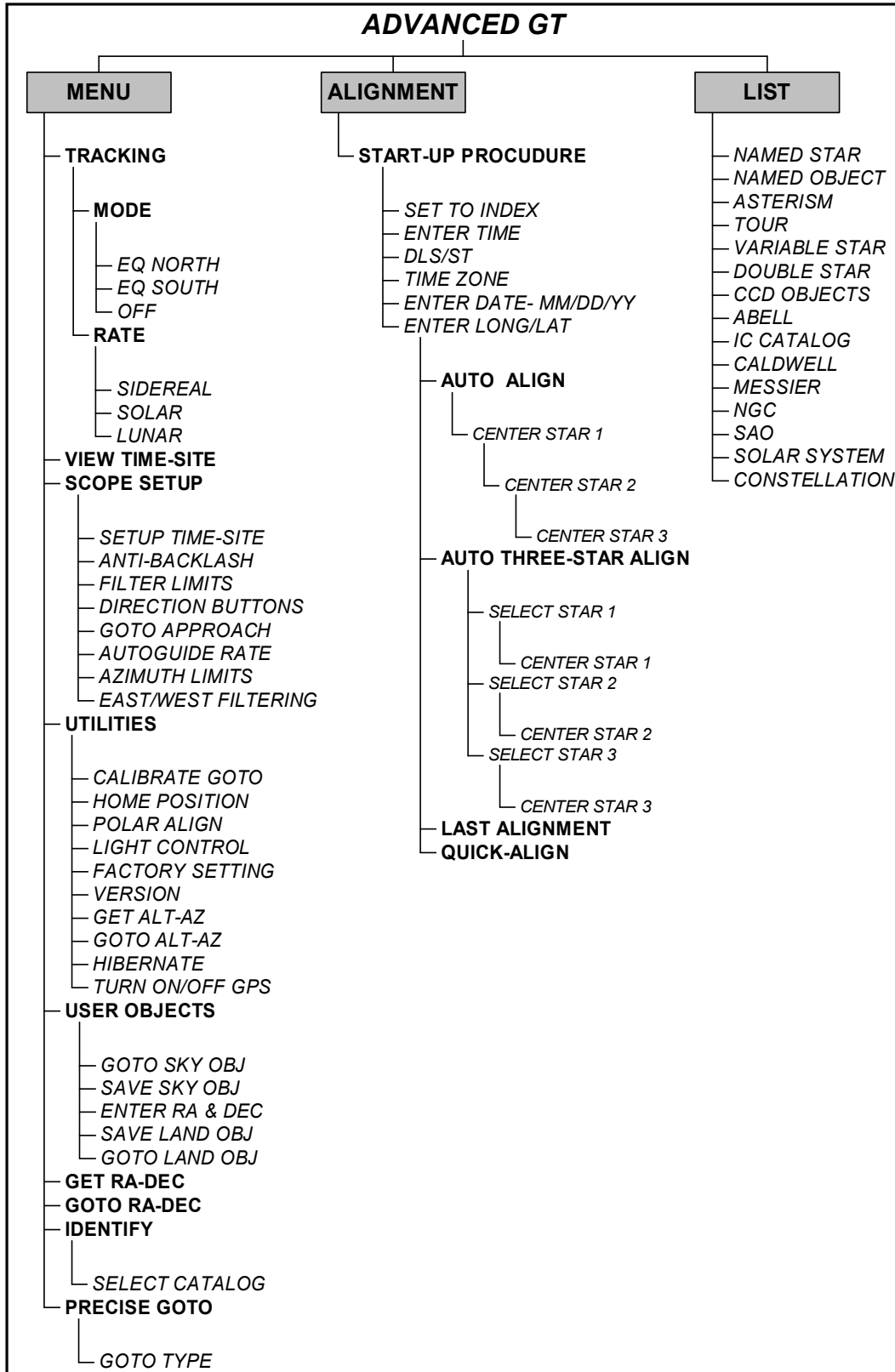



Telescope Basics

A telescope is an instrument that collects and focuses light. The nature of the optical design determines how the light is focused. Some telescopes, known as refractors, use lenses. Other telescopes, known as reflectors, use mirrors. A Newtonian reflector uses a single concave mirror as its primary. Light enters the tube traveling to the mirror at the back end. There light is bent forward in the tube to a single point, its focal point. Since putting your head in front of the telescope to look at the image with an eyepiece would keep the reflector from working, a flat mirror called a *diagonal* intercepts the light and points it out the side of the tube at right angles to the tube. The eyepiece is placed there for easy viewing.

Newtonian Reflector telescopes replace heavy lenses with mirrors to collect and focus the light, providing much more light-gathering power for the dollar. Because the light path is intercepted and reflected out to the side, you can have focal lengths up to 1000mm and still enjoy a telescope that is relatively compact and portable. A Newtonian Reflector telescope offers such impressive light-gathering characteristics you can take a serious interest in deep space astronomy even on a modest budget. Newtonian Reflector telescopes do require more care and maintenance because the primary mirror is exposed to air and dust. However, this small drawback does not hamper this type of telescope's popularity with those who want an economical telescope that can still resolve faint, distant objects.

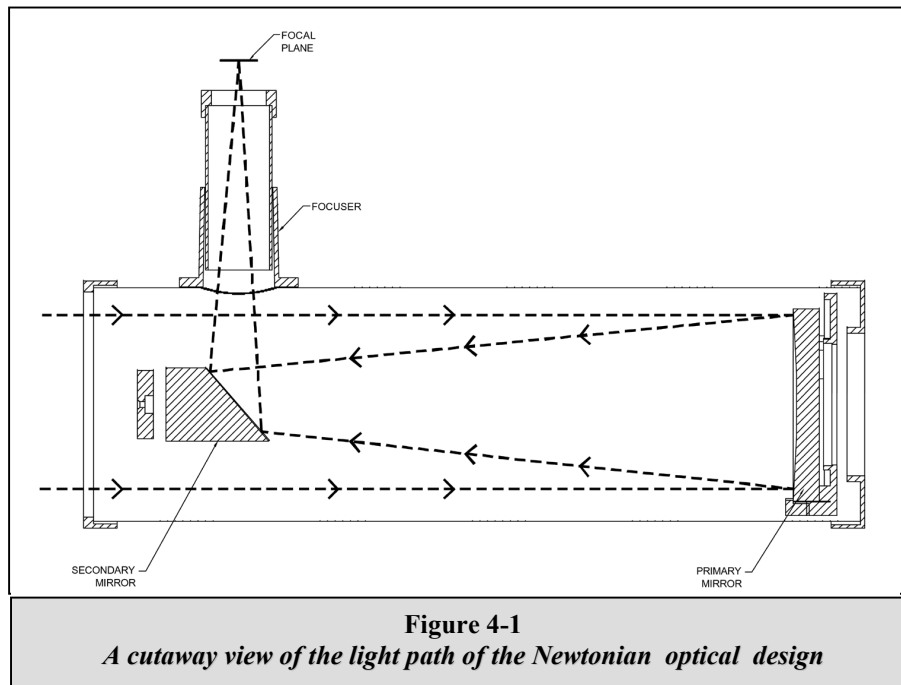

Image Orientation

Newtonian reflectors produce a right-side-up image but the image will appear rotated based on the location of the eyepiece holder in relation to the ground. Newtonian reflectors are best for astronomical use where right-side-up does not matter.

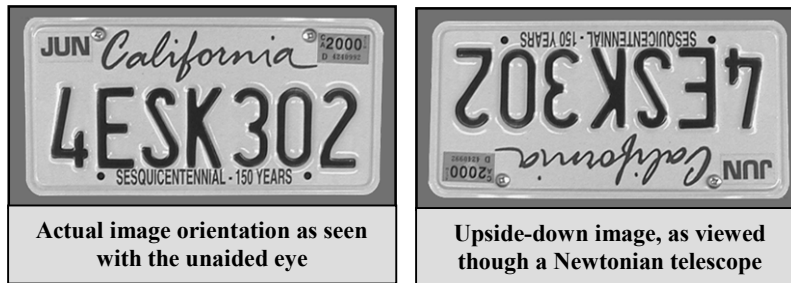

Figure 4-2

Focusing

To focus your telescope, simply turn the focus knob located directly below the eyepiece holder. Turning the knob clockwise allows you to focus on an object that is farther than the one you are currently observing. Turning the knob counterclockwise from you allows you to focus on an object closer than the one you are currently observing.

- If you wear corrective lenses (specifically glasses), you may want to remove them when observing with an eyepiece attached to the telescope. However, when using a camera you should always wear corrective lenses to ensure the sharpest possible focus. If you have astigmatism, corrective lenses must be worn at all times.

Aligning the Finderscope

Accurate alignment of the finder makes it easy to find objects with the telescope, especially celestial objects. To make aligning the finder as easy as possible, this procedure should be done in the daytime when it is easy to find and identify objects. The finderscope has a spring-loaded adjustment screw that puts pressure on the finderscope while the remaining screws are used to adjust the finder horizontally and vertically. To align the finder:

- 1 Choose a target that is in excess of one mile away. This eliminates any possible parallax effect between the telescope and finder.
- 2 Release the R.A. and DEC clamps and point the telescope at your target.
- 3 Center your target in the main optics of the telescope. You may have to move the telescope slightly to center it.
- 4 Adjust the screw on the finder bracket that is on the right (when looking through the finder) until the crosshairs are centered horizontally on the target seen through the telescope.
- 5 Adjust the screw on the top of the finder bracket until the crosshairs are centered vertically on the target seen through the telescope.

Image orientation through the finder is inverted (i.e., upside down and backwards left-to-right). This is normal for any finder that is used straight-through. Because of this, it may take a few minutes to familiarize yourself with the directional change each screw makes on the finder.

Calculating Magnification

You can change the power of your telescope just by changing the eyepiece (ocular). To determine the magnification of your telescope, simply divide the focal length of the telescope by the focal length of the eyepiece used. In equation format, the formula looks like this:

$$\text{Magnification} = \frac{\text{Focal Length of Telescope (mm)}}{\text{Focal Length of Eyepiece (mm)}}$$

Let's say, for example, you are using the 20mm eyepiece. To determine the magnification you simply divide the focal length of your telescope (the C8-N for example has a focal length of 1000mm) by the focal length of the eyepiece, 20mm. Dividing 1000 by 20 yields a magnification of 50 power.

Although the power is variable, each instrument under average skies has a limit to the highest useful magnification. The general rule is that 60 power can be used for every inch of aperture. For example, the C8-N is 8 inches in diameter. Multiplying 8 by 60 gives a maximum useful magnification of 480 power. Although this is the maximum useful magnification, most observing is done in the range of 20 to 35 power for every inch of aperture which is 160 to 280 times for the C8-N telescope.

Determining Field of View

Determining the field of view is important if you want to get an idea of the angular size of the object you are observing. To calculate the actual field of view, divide the apparent field of the eyepiece (supplied by the eyepiece manufacturer) by the magnification. In equation format, the formula looks like this:

$$\text{True Field} = \frac{\text{Apparent Field of Eyepiece}}{\text{Magnification}}$$

As you can see, before determining the field of view, you must calculate the magnification. Using the example in the previous section, we can determine the field of view using the same 20mm eyepiece. The 20mm eyepiece has an apparent field of view of 50°. Divide the 50° by the magnification, which is 50 power. This yields an actual field of 1°, or a full degree.

To convert degrees to feet at 1,000 yards, which is more useful for terrestrial observing, simply multiply by 52.5. Continuing with our example, multiply the angular field 1° by 52.5. This produces a linear field width of 52.5 feet at a distance of one thousand yards. The apparent field of each eyepiece that Celestron manufactures is found in the Celestron Accessory Catalog (#93685).

General Observing Hints

When working with any optical instrument, there are a few things to remember to ensure you get the best possible image.

- Never look through window glass. Glass found in household windows is optically imperfect, and as a result, may vary in thickness from one part of a window to the next. This inconsistency can and will affect the ability to focus your telescope. In most cases you will not be able to achieve a truly sharp image, while in some cases, you may actually see a double image.
- Never look across or over objects that are producing heat waves. This includes asphalt parking lots on hot summer days or building rooftops.
- Hazy skies, fog, and mist can also make it difficult to focus when viewing terrestrially. The amount of detail seen under these conditions is greatly reduced. Also, when photographing under these conditions, the processed film may come out a little grainier than normal with lower contrast and underexposed.
- If you wear corrective lenses (specifically glasses), you may want to remove them when observing with an eyepiece attached to the telescope. When using a camera, however, you should always wear corrective lenses to ensure the sharpest possible focus. If you have astigmatism, corrective lenses must be worn at all times.



Astronomy Basics

Up to this point, this manual covered the assembly and basic operation of your telescope. However, to understand your telescope more thoroughly, you need to know a little about the night sky. This section deals with observational astronomy in general and includes information on the night sky and polar alignment.

The Celestial Coordinate System

To help find objects in the sky, astronomers use a celestial coordinate system that is similar to our geographical coordinate system here on Earth. The celestial coordinate system has poles, lines of longitude and latitude, and an equator. For the most part, these remain fixed against the background stars.

The celestial equator runs 360 degrees around the Earth and separates the northern celestial hemisphere from the southern. Like the Earth's equator, it bears a reading of zero degrees. On Earth this would be latitude. However, in the sky this is referred to as declination, or DEC for short. Lines of declination are named for their angular distance above and below the celestial equator. The lines are broken down into degrees, minutes of arc, and seconds of arc. Declination readings south of the equator carry a minus sign (-) in front of the coordinate and those north of the celestial equator are either blank (i.e., no designation) or preceded by a plus sign (+).

The celestial equivalent of longitude is called Right Ascension, or R.A. for short. Like the Earth's lines of longitude, they run from pole to pole and are evenly spaced 15 degrees apart. Although the longitude lines are separated by an angular distance, they are also a measure of time. Each line of longitude is one hour apart from the next. Since the Earth rotates once every 24 hours, there are 24 lines total. As a result, the R.A. coordinates are marked off in units of time. It begins with an arbitrary point in the constellation of Pisces designated as 0 hours, 0 minutes, 0 seconds. All other points are designated by how far (i.e., how long) they lag behind this coordinate after it passes overhead moving toward the west.

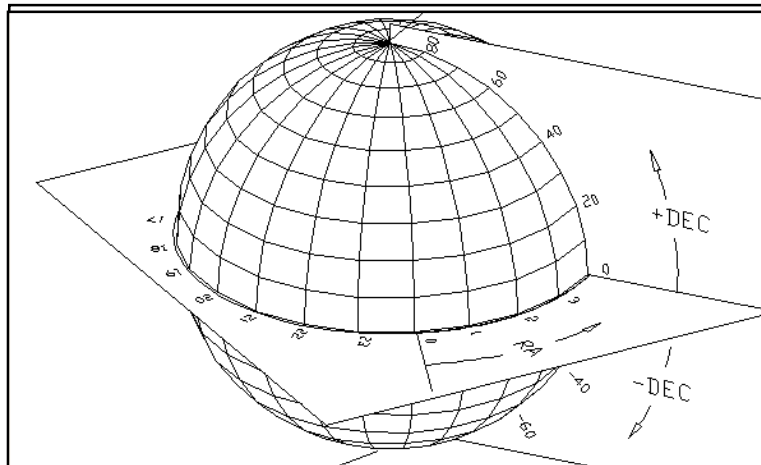
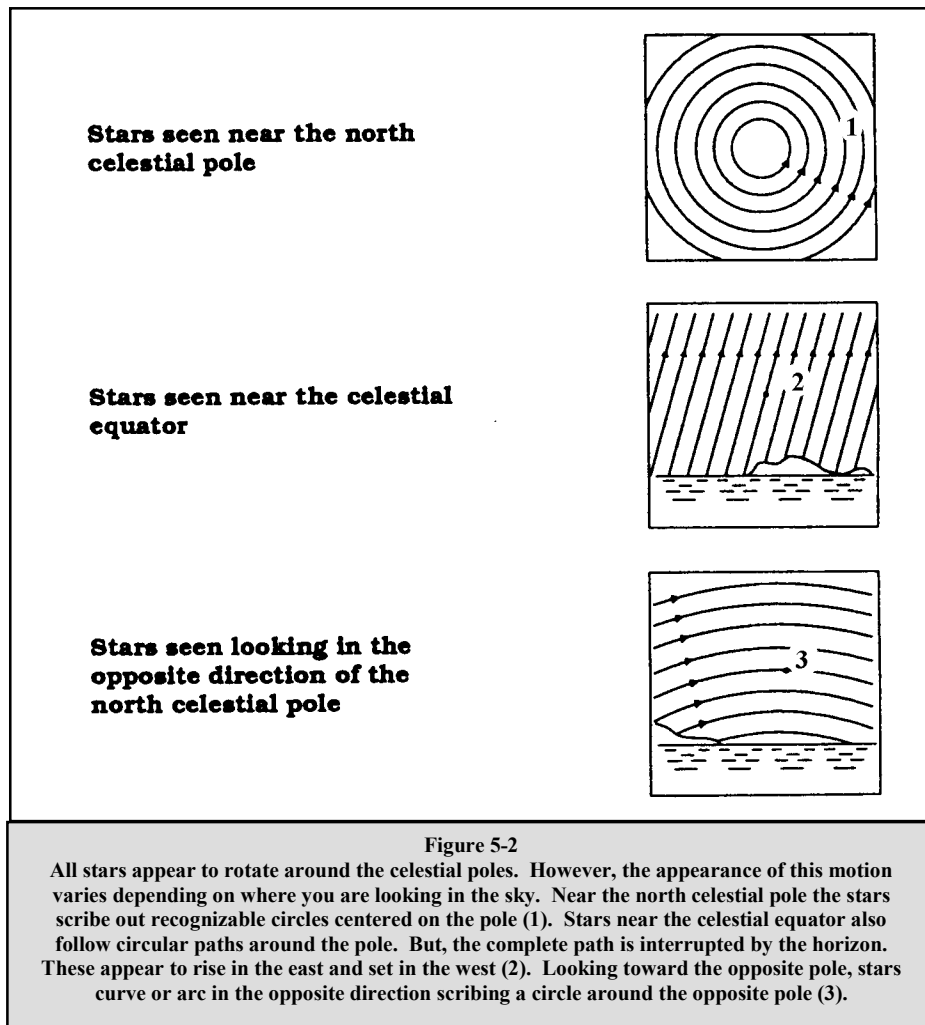

Figure 5-1
The celestial sphere seen from the outside showing R.A. and DEC.

Motion of the Stars

The daily motion of the Sun across the sky is familiar to even the most casual observer. This daily trek is not the Sun moving as early astronomers thought, but the result of the Earth's rotation. The Earth's rotation also causes the stars to do the same, scribing out a large circle as the Earth completes one rotation. The size of the circular path a star follows depends on where it is in the sky. Stars near the celestial equator form the largest circles rising in the east and setting in the west. Moving toward the north celestial pole, the point around which the stars in the northern hemisphere appear to rotate, these circles become smaller. Stars in the mid-celestial latitudes rise in the northeast and set in the northwest. Stars at high celestial latitudes are always above the horizon, and are said to be circumpolar because they never rise and never set. You will never see the stars complete one circle because the sunlight during the day washes out the starlight. However, part of this circular motion of stars in this region of the sky can be seen by setting up a camera on a tripod and opening the shutter for a couple hours. The processed film will reveal semicircles that revolve around the pole. (This description of stellar motions also applies to the southern hemisphere except all stars south of the celestial equator move around the south celestial pole.)



Latitude Scales

The easiest way to polar align a telescope is with a latitude scale. Unlike other methods that require you to find the celestial pole by identifying certain stars near it, this method works off of a known constant to determine how high the polar axis should be pointed. The Advanced Series mount can be adjusted from 30 to 60 degrees (see figure 5-3).

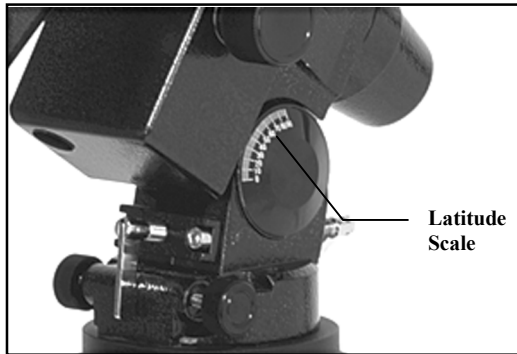

Figure 5-3

The constant, mentioned above, is a relationship between your latitude and the angular distance the celestial pole is above the northern (or southern) horizon; The angular distance from the northern horizon to the north celestial pole is always equal to your latitude. To illustrate this, imagine that you are standing on the north pole, latitude $+90^\circ$. The north celestial pole, which has a declination of $+90^\circ$, would be directly overhead (i.e., 90° above the horizon). Now, let's say that you move one degree south — your latitude is now $+89^\circ$ and the celestial pole is no longer directly overhead. It has moved one degree closer toward the northern horizon. This means the pole is now 89° above the northern horizon. If you move one degree further south, the same thing happens again.

You would have to travel 70 miles north or south to change your latitude by one degree. As you can see from this example, the distance from the northern horizon to the celestial pole is always equal to your latitude.

If you are observing from Los Angeles, which has a latitude of 34° , then the celestial pole is 34° above the northern horizon. All a latitude scale does then is to point the polar axis of the telescope at the right elevation above the northern (or southern) horizon. To align your telescope:

1. Make sure the polar axis of the mount is pointing due north. Use a landmark that you know faces north.
2. Level the tripod. There is a bubble level built into the mount for this purpose.

NOTE: Leveling the tripod is only necessary if using this method of polar alignment. Perfect polar alignment is still possible using other methods described later in this manual without leveling the tripod.

3. Adjust the mount in altitude until the latitude indicator points to your latitude. Moving the mount affects the angle the polar axis is pointing. For specific information on adjusting the equatorial mount, please see the section "Adjusting the Mount."

This method can be done in daylight, thus eliminating the need to fumble around in the dark. Although this method does **NOT** put you directly on the pole, it will limit the number of corrections you will make when tracking an object. It will also be accurate enough for short exposure prime focus planetary photography (a couple of seconds) and short exposure piggyback astrophotography (a couple of minutes).

Pointing at Polaris

This method utilizes Polaris as a guidepost to the celestial pole. Since Polaris is less than a degree from the celestial pole, you can simply point the polar axis of your telescope at Polaris. Although this is by no means perfect alignment, it does get you within one degree. Unlike the previous method, this must be done in the dark when Polaris is visible.

1. Set the telescope up so that the polar axis is pointing north.
2. Loosen the DEC clutch knob and move the telescope so that the tube is parallel to the polar axis. When this is done, the declination setting circle will read $+90^\circ$. If the declination setting circle is not aligned, move the telescope so that the tube is parallel to the polar axis.
3. Adjust the mount in altitude and/or azimuth until Polaris is in the field of view of the finder.
4. Center Polaris in the field of the telescope using the fine adjustment controls on the mount.

Remember, while Polar aligning, do NOT move the telescope in R.A. or DEC. You do not want to move the telescope itself, but the polar axis. The telescope is used simply to see where the polar axis is pointing.

Like the previous method, this gets you close to the pole but not directly on it. The following methods help improve your accuracy for more serious observations and photography.

Finding the North Celestial Pole

In each hemisphere, there is a point in the sky around which all the other stars appear to rotate. These points are called the celestial poles and are named for the hemisphere in which they reside. For example, in the northern hemisphere all stars move around the north celestial pole. When the telescope's polar axis is pointed at the celestial pole, it is parallel to the Earth's rotational axis.

Many methods of polar alignment require that you know how to find the celestial pole by identifying stars in the area. For those in the northern hemisphere, finding the celestial pole is not too difficult. Fortunately, we have a naked eye star less than a degree away. This star, Polaris, is the end star in the handle of the Little Dipper. Since the Little Dipper (technically called Ursa Minor) is not one of the brightest constellations in the sky, it may be difficult to locate from urban areas. If this is the case, use the two end stars in the bowl of the Big Dipper (the pointer stars). Draw an imaginary line through them toward the Little Dipper. They point to Polaris (see Figure 5-5). The position of the Big Dipper changes during the year and throughout the course of the night (see Figure 5-4). When the Big Dipper is low in the sky (i.e., near the horizon), it may be difficult to locate. During these times, look for Cassiopeia (see Figure 5-5). Observers in the southern hemisphere are not as fortunate as those in the northern hemisphere. The stars around the south celestial pole are not nearly as bright as those around the north. The closest star that is relatively bright is Sigma Octantis. This star is just within naked eye limit (magnitude 5.5) and lies about 59 arc minutes from the pole.

Definition

The north celestial pole is the point in the northern hemisphere around which all stars appear to rotate. The counterpart in the southern hemisphere is referred to as the south celestial pole.

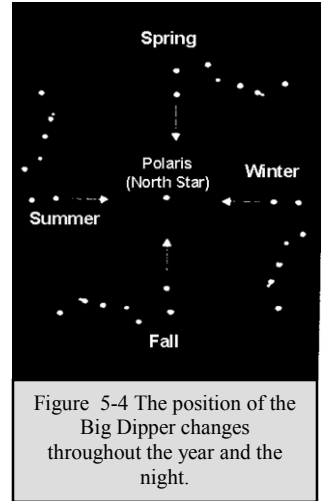

Figure 5-4 The position of the Big Dipper changes throughout the year and the night.

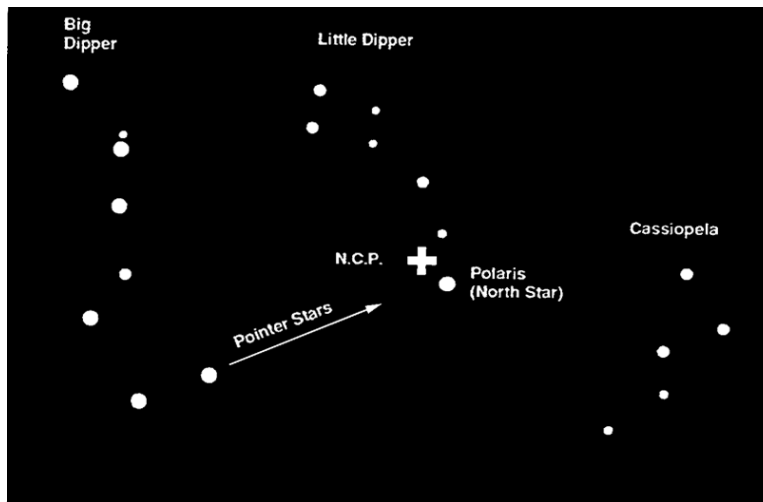

Figure 5-5

The two stars in the front of the bowl of the Big Dipper point to Polaris which is less than one degree from the true (north) celestial pole. Cassiopeia, the "W" shaped constellation, is on the opposite side of the pole from the Big Dipper. The North Celestial Pole (N.C.P.) is marked by the "+" sign.

Declination Drift Method of Polar Alignment

This method of polar alignment allows you to get the most accurate alignment on the celestial pole and is required if you want to do long exposure deep-sky astrophotography through the telescope. The declination drift method requires that you monitor the drift of selected stars. The drift of each star tells you how far away the polar axis is pointing from the true celestial pole and in what direction. Although declination drift is simple and straight-forward, it requires a great deal of time and patience to complete when first attempted. The declination drift method should be done after any one of the previously mentioned methods has been completed.

To perform the declination drift method you need to choose two bright stars. One should be near the eastern horizon and one due south near the meridian. Both stars should be near the celestial equator (i.e., 0° declination). You will monitor the drift of each star one at a time and in declination only. While monitoring a star on the meridian, any misalignment in the east-west direction is revealed. While monitoring a star near the east/west horizon, any misalignment in the north-south direction is revealed. It is helpful to have an illuminated reticle eyepiece to help you recognize any drift. For very close alignment, a Barlow lens is also recommended since it increases the magnification and reveals any drift faster. When looking due south, insert the diagonal so the eyepiece points straight up. Insert the cross hair eyepiece and align the cross hairs so that one is parallel to the declination axis and the other is parallel to the right ascension axis. Move your telescope manually in R.A. and DEC to check parallelism.

First, choose your star near where the celestial equator and the meridian meet. The star should be approximately within 1/2 an hour of the meridian and within five degrees of the celestial equator. Center the star in the field of your telescope and monitor the drift in declination.

- If the star drifts south, the polar axis is too far east.
- If the star drifts north, the polar axis is too far west.

Make the appropriate adjustments to the polar axis to eliminate any drift. Once you have eliminated all the drift, move to the star near the eastern horizon. The star should be 20 degrees above the horizon and within five degrees of the celestial equator.

- If the star drifts south, the polar axis is too low.
- If the star drifts north, the polar axis is too high.

Again, make the appropriate adjustments to the polar axis to eliminate any drift. Unfortunately, the latter adjustments interact with the prior adjustments ever so slightly. So, repeat the process again to improve the accuracy checking both axes for minimal drift. Once the drift has been eliminated, the telescope is very accurately aligned. You can now do prime focus deep-sky astrophotography for long periods.

NOTE: If the eastern horizon is blocked, you may choose a star near the western horizon, but you must reverse the polar high/low error directions. Also, if using this method in the southern hemisphere, the direction of drift is reversed for both R.A. and DEC.

Celestial Observing

With your telescope set up, you are ready to use it for observing. This section covers visual observing hints for both solar system and deep sky objects as well as general observing conditions which will affect your ability to observe.

Observing the Moon

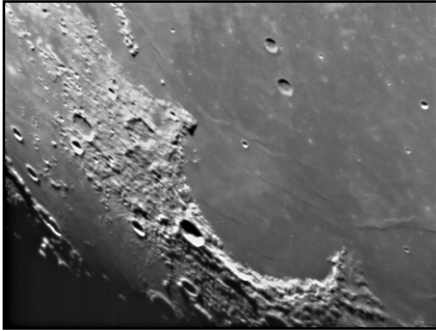

Often, it is tempting to look at the Moon when it is full. At this time, the face we see is fully illuminated and its light can be overpowering. In addition, little or no contrast can be seen during this phase.

One of the best times to observe the Moon is during its partial phases (around the time of first or third quarter). Long shadows reveal a great amount of detail on the lunar surface. At low power you will be able to see most of the lunar disk at one time. Change to higher power (magnification) to focus in on a smaller area. Choose the *lunar* tracking rate from the hand control's MENU tracking rate options to keep the moon centered in the eyepiece even at high magnifications.

Lunar Observing Hints

To increase contrast and bring out detail on the lunar surface, use filters. A yellow filter works well at improving contrast while a neutral density or polarizing filter will reduce overall surface brightness and glare.

Observing the Planets

Other fascinating targets include the five naked eye planets. You can see Venus go through its lunar-like phases. Mars can reveal a host of surface detail and one, if not both, of its polar caps. You will be able to see the cloud belts of Jupiter and the great Red Spot (if it is visible at the time you are observing). In addition, you will also be able to see the moons of Jupiter as they orbit the giant planet. Saturn, with its beautiful rings, is easily visible at moderate power.

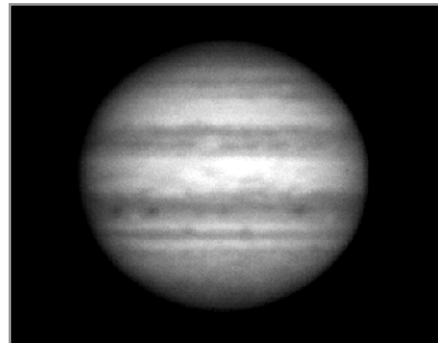

Planetary Observing Hints

- Remember that atmospheric conditions are usually the limiting factor on how much planetary detail will be visible. So, avoid observing the planets when they are low on the horizon or when they are directly over a source of radiating heat, such as a rooftop or chimney. See the "Seeing Conditions" section later in this section.
- To increase contrast and bring out detail on the planetary surface, try using Celestron eyepiece filters.

Observing the Sun

Although overlooked by many amateur astronomers, solar observation is both rewarding and fun. However, because the Sun is so bright, special precautions must be taken when observing our star so as not to damage your eyes or your telescope.

Never project an image of the Sun through the telescope. Because of the folded optical design, tremendous heat build-up will result inside the optical tube. This can damage the telescope and/or any accessories attached to the telescope.

For safe solar viewing, use a solar filter that reduces the intensity of the Sun's light, making it safe to view. With a filter you can see sunspots as they move across the solar disk and faculae, which are bright patches seen near the Sun's edge.

Solar Observing Hints

- The best time to observe the Sun is in the early morning or late afternoon when the air is cooler.
- To center the Sun without looking into the eyepiece, watch the shadow of the telescope tube until it forms a circular shadow.
- To ensure accurate tracking, be sure to select the solar tracking rate.

Observing Deep Sky Objects

Deep-sky objects are simply those objects outside the boundaries of our solar system. They include star clusters, planetary nebulae, diffuse nebulae, double stars and other galaxies outside our own Milky Way. Most deep-sky objects have a large angular size. Therefore, low-to-moderate power is all you need to see them. Visually, they are too faint to reveal any of the color seen in long exposure photographs. Instead, they appear black and white. And, because of their low surface brightness, they should be observed from a dark-sky location. Light pollution around large urban areas washes out most nebulae making them difficult, if not impossible, to observe. Light Pollution Reduction filters help reduce the background sky brightness, thus increasing contrast.

Seeing Conditions

Viewing conditions affect what you can see through your telescope during an observing session. Conditions include transparency, sky illumination, and seeing. Understanding viewing conditions and the effect they have on observing will help you get the most out of your telescope.

Transparency

Transparency is the clarity of the atmosphere which is affected by clouds, moisture, and other airborne particles. Thick cumulus clouds are completely opaque while cirrus can be thin, allowing the light from the brightest stars through. Hazy skies absorb more light than clear skies making fainter objects harder to see and reducing contrast on brighter objects. Aerosols ejected into the upper atmosphere from volcanic eruptions also affect transparency. Ideal conditions are when the night sky is inky black.

Sky Illumination

General sky brightening caused by the Moon, aurorae, natural airglow, and light pollution greatly affect transparency. While not a problem for the brighter stars and planets, bright skies reduce the contrast of extended nebulae making them difficult, if not impossible, to see. To maximize your observing, limit deep sky viewing to moonless nights far from the light polluted skies found around major urban areas. LPR filters enhance deep sky viewing from light polluted areas by blocking unwanted light while transmitting light from certain deep sky objects. You can, on the other hand, observe planets and stars from light polluted areas or when the Moon is out.

Seeing

Seeing conditions refers to the stability of the atmosphere and directly affects the amount of fine detail seen in extended objects. The air in our atmosphere acts as a lens which bends and distorts incoming light rays. The amount of bending depends on air density. Varying temperature layers have different densities and, therefore, bend light differently. Light rays from the same object arrive slightly displaced creating an imperfect or smeared image. These atmospheric

disturbances vary from time-to-time and place-to-place. The size of the air parcels compared to your aperture determines the "seeing" quality. Under good seeing conditions, fine detail is visible on the brighter planets like Jupiter and Mars, and stars are pinpoint images. Under poor seeing conditions, images are blurred and stars appear as blobs.

The conditions described here apply to both visual and photographic observations.

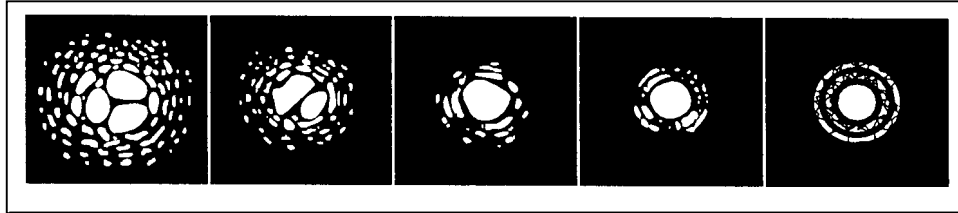

Figure 6-1

Seeing conditions directly affect image quality. These drawings represent a point source (i.e., star) under bad seeing conditions (left) to excellent conditions (right). Most often, seeing conditions produce images that lie some where between these two extremes.

Astrophotography

After looking at the night sky for a while you may want to try photographing it. Several forms of photography are possible with your telescope, including terrestrial and celestial photography. Both of these are discussed in moderate detail with enough information to get you started. Topics include the accessories required and some simple techniques. More information is available in some of the publications listed at the end of this manual.

In addition to the specific accessories required for each type of celestial photography, there is the need for a camera - but not just any camera. The camera does not have to have many of the features offered on today's state-of-the-art equipment. For example, you don't need auto focus capability or mirror lock up. Here are the mandatory features a camera needs for celestial photography. First, a "B" setting which allows for time exposures. This excludes point and shoot cameras and limits the selection to SLR cameras, the most common type of 35mm camera on the market today.

Second, the "B" or manual setting should NOT run off the battery. Many new electronic cameras use the battery to keep the shutter open during time exposures. Once the batteries are drained, usually after a few minutes, the shutter closes, whether you were finished with the exposure or not. Look for a camera that has a manual shutter when operating in the time exposure mode. Olympus, Nikon, Minolta, Pentax, Canon and others have made such camera bodies.

The camera must have interchangeable lenses so you can attach it to the telescope and so you can use a variety of lenses for piggyback photography. If you can't find a new camera, you can purchase a used camera body that is not 100-percent functional. The light meter, for example, does not have to be operational since you will be determining the exposure length manually.

You also need a cable release with a locking function to hold the shutter open while you do other things. Mechanical and air release models are available.

Piggyback

The easiest way to enter the realm of deep-sky, long exposure astrophotography is via the piggyback method. Piggyback photography is done with a camera and its normal lens riding on top of the telescope. Through piggyback photography you can capture entire constellations and record large scale nebulae that are too big for prime focus photography. Because you are photographing with a low power lens and guiding with a high power telescope, the margin for error is very large. Small mistakes made while guiding the telescope will not show up on film. To attach the camera to the telescope, use the piggyback adapter screw located on the top of the tube mounting ring. It may be necessary to remove the finder scope bracket before attaching the camera

As with any form of deep-sky photography, it should be done from a dark sky observing site. Light pollution around major urban areas washes out the faint light of deep-sky objects. You can still practice from less ideal skies.

1. Polar align the telescope (using one of the methods described earlier) and start the motor drive.
2. Load your camera with slide film, ISO 100 or faster, or print film, ISO 400 or faster!
3. Set the f /ratio of your camera lens so that it is a half stop to one full stop down from completely open.
4. Set the shutter speed to the "B" setting and focus the lens to the infinity setting.
5. Locate the area of the sky that you want to photograph and move the telescope so that it points in that direction.

6. Find a suitable guide star in the telescope eyepiece field of view. This is relatively easy since you can search a wide area without affecting the area covered by your camera lens. If you do not have an illuminated cross hair eyepiece for guiding, simply defocus your guide star until it fills most of the field of view. This makes it easy to detect any drift.
7. Release the shutter using a cable release.
8. Monitor your guide star for the duration of the exposure making the necessary corrections needed to keep the star centered.

Short Exposure Prime Focus Photography

Short exposure prime focus photography is the best way to begin recording celestial objects. It is done with the camera attached to the telescope without an eyepiece or camera lens in place. To attach your camera, you need the T-adapter and a T-Ring for your specific camera (i.e., Minolta, Nikon, Pentax, etc.). The C8-N and C10-N focuser have a built-in T-adapter and are ready to accept a 35mm camera body. The T-Ring replaces the 35mm SLR camera's normal lens. Prime focus photography allows you to capture the entire solar disk (if using the proper filter) as well as the entire lunar disk. To attach your camera to your telescope:

1. Remove the eyepiece from the 1 1/4" eyepiece holder.
2. Unthread the 1 1/4" eyepiece holder from the focuser assembly. This will expose the male thread of the built-in T-adapter.
3. Thread the T-ring onto the exposed T-adapter threads.
4. Mount your camera body onto the T-Ring the same as you would any other lens.

With your camera attached to the telescope, you are ready for prime focus photography. Start with an easy object like the Moon. Here's how to do it:

1. Load your camera with film that has a moderate-to-fast speed (i.e., ISO rating). Faster films are more desirable when the Moon is a crescent. When the Moon is near full, and at its brightest, slower films are more desirable. Here are some film recommendations:
 - T-Max 100
 - T-Max 400
 - Any 100 to 400 ISO color slide film
 - Fuji Super HG 400
2. Center the Moon in the field of your telescope.
3. Focus the telescope by turning the focus knob until the image is sharp.
4. Set the shutter speed to the appropriate setting (see table 7-1).
5. Trip the shutter using a cable release.
6. Advance the film and repeat the process.

Lunar Phase	ISO 50	ISO 100	ISO 200	ISO 400
Crescent	1/2	1/4	1/8	1/15
Quarter	1/15	1/30	1/60	1/125
Full	1/30	1/60	1/125	1/250

Table 7-1
Above is a listing of recommended exposure times when photographing the Moon at the prime focus of your telescope.

The exposure times listed in table 7-1 should be used as a starting point. Always make exposures that are longer and shorter than the recommended time. Also, take a few photos at each shutter speed. This will ensure that you will get a good photo.

- If using black and white film, try a yellow filter to reduce the light intensity and to increase contrast.
- Keep accurate records of your exposures. This information is useful if you want to repeat your results or if you want to submit some of your photos to various astronomy magazines for possible publication!
- This technique is also used for photographing the Sun with the proper solar filter.

Terrestrial Photography

Your telescope makes an excellent telephoto lens for terrestrial (land) photography. Terrestrial photography is best done with the telescope tracking drive turned off. To turn the tracking drive off, press the MENU (9) button on the hand control and scroll down to the Tracking Mode sub menu. Use the Up and Down scroll keys (10) to select the Off option and press ENTER. This will turn the tracking motors off, so that objects will remain in your camera's field of view.

Metering

The Advanced Series telescope has a fixed aperture and, as a result, fixed f/ratios. To properly expose your subjects photographically, you need to set your shutter speed accordingly. Most 35mm SLR cameras offer through-the-lens metering which lets you know if your picture is under or overexposed. Adjustments for proper exposures are made by changing the shutter speed. Consult your camera manual for specific information on metering and changing shutter speeds.

Reducing Vibration

Releasing the shutter manually can cause vibrations, producing blurred photos. To reduce vibration when tripping the shutter, use a cable release. A cable release keeps your hands clear of the camera and lens, thus eliminating the possibility of introducing vibration. Mechanical shutter releases can be used, though air-type releases are best. Blurry pictures can also result from shutter speeds that are too slow. To prevent this, use films that produce shutter speeds greater than 1/250 of a second when hand-holding the lens. If the lens is mounted on a tripod, the exposure length is virtually unlimited.

Another way to reduce vibration is with the Vibration Suppression Pads (#93503). These pads rest between the ground and tripod feet. They reduce the vibration amplitude and vibration time.

Auto Guiding

The Advanced GT telescope has a designated auto guiding port for use with a CCD autoguider. The diagram below may be useful when connecting the CCD camera cable to the telescope and calibrating the autoguider. Note that the four outputs are active-low, with internal pull-ups and are capable of sinking 25 mA DC.

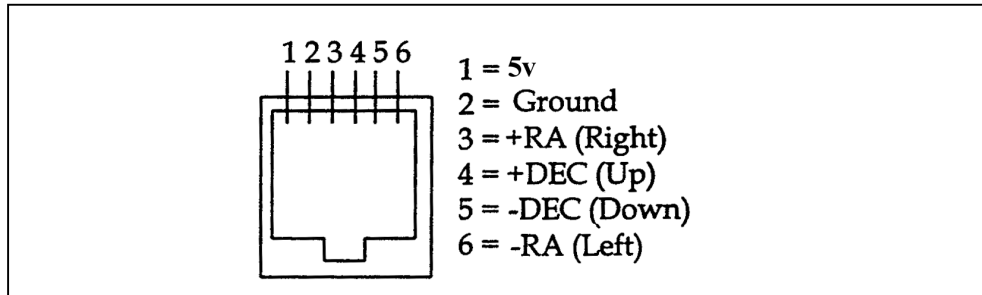



Telescope Maintenance

While your telescope requires little maintenance, there are a few things to remember that will ensure your telescope performs at its best.

Care and Cleaning of the Optics

Occasionally, dust and/or moisture may build up on the mirrors of your telescope. Special care should be taken when cleaning any instrument so as not to damage the optics.

If dust has built up on the mirror, remove it with a brush (made of camel's hair) or a can of pressurized air. Spray at an angle to the mirror for approximately two to four seconds. Then, use an optical cleaning solution and white tissue paper to remove any remaining debris. Apply the solution to the tissue and then apply the tissue paper to the mirror. Low pressure strokes should go from the center of the mirror to the outer portion. **Do NOT rub in circles!**

You can use a commercially made lens cleaner or mix your own. A good cleaning solution is isopropyl alcohol mixed with distilled water. The solution should be 60% isopropyl alcohol and 40% distilled water. Or, liquid dish soap diluted with water (a couple of drops per one quart of water) can be used.

To minimize the need to clean your telescope, replace all lens covers once you have finished using it. Since the telescope tube is NOT sealed, the cover should be placed over the opening when not in use. This will prevent contaminants from entering the optical tube.

Collimation

The optical performance of most Newtonian reflecting telescopes can be optimized by re-collimating (aligning) the telescope's optics, as needed. To collimate the telescope simply means to bring its optical elements into balance. Poor collimation will result in optical aberrations and distortions.

Before collimating your telescope, take time to familiarize yourself with all its components. The primary mirror is the large mirror at the back end of the telescope tube. This mirror is adjusted by loosening and tightening the three screws, placed 120 degrees apart, at the end of the telescope tube. The secondary mirror (the small, elliptical mirror under the focuser, in the front of the tube) also has three adjustment screws. To determine if your telescope needs collimation first point your telescope toward a bright wall or blue sky outside.



Never look directly at the sun with the naked eye or with a telescope (unless you have the proper solar filter). Permanent and irreversible eye damage may result.

Aligning the Secondary Mirror

The following describes the procedure for daytime collimation of your telescope using the optional Newtonian Collimation Tool (#94183) offered by Celestron. To collimate the telescope without the Collimation Tool, read the following section on night time star collimation.

If you have an eyepiece in the focuser, remove it. Rack the focuser tube in completely, using the focusing knobs, until its silver tube is no longer visible. You will be looking through the focuser at a reflection of the secondary mirror, projected from the primary mirror. During this step, ignore the silhouetted reflection from the primary mirror. Insert the collimating cap into the focuser and look through it. With the focus pulled in all the way, you should be able to see the entire primary mirror reflected in the secondary mirror. If the primary mirror is not centered in the secondary mirror, adjust the secondary mirror screws by alternately tightening and loosening them until the periphery of the primary mirror is centered in your view. **DO NOT** loosen or tighten the center screw in the secondary mirror support, because it maintains proper mirror position.

Aligning the Primary Mirror

Now adjust the primary mirror screws to re-center the reflection of the small secondary mirror, so it's silhouetted against the view of the primary. As you look into the focuser, silhouettes of the mirrors should look concentric. Repeat steps one and two until you have achieved this.

Remove the collimating cap and look into the focuser, where you should see the reflection of your eye in the secondary mirror.

Newtonian collimation views as seen through the focuser using the collimation cap

Secondary mirror needs adjustment.

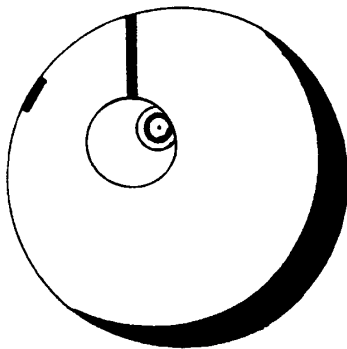

Primary mirror needs adjustment.

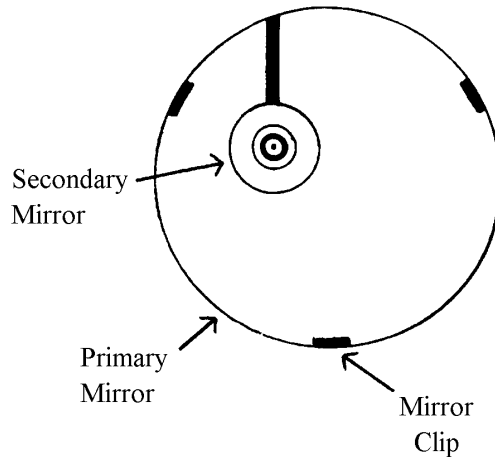

Both mirrors aligned with the collimating cap in the focuser.

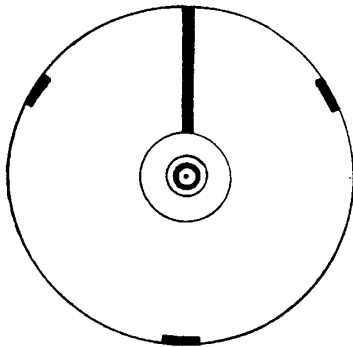

Both mirrors aligned with your eye looking into the focuser.

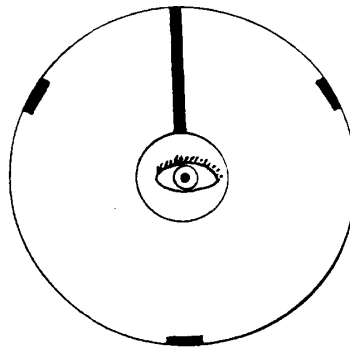

Night Time Star Collimating

After successfully completing daytime collimation, night time star collimation can be done by closely adjusting the primary mirror while the telescope tube is on its mount and pointing at a bright star. The telescope should be set up at night and a star's image should be studied at medium to high power (30-60 power per inch of aperture). If a non-symmetrical focus pattern is present, then it may be possible to correct this by re-collimating only the primary mirror.

Procedure

(Please read this section completely before beginning)

To star collimate in the Northern Hemisphere, point at a stationary star like the North Star (Polaris). It can be found in the north sky, at a distance above the horizon equal to your latitude. It's also the end star in the handle of the Little Dipper. Polaris is not the brightest star in the sky and may even appear dim, depending upon your sky conditions.

Prior to re-collimating the primary mirror, locate the collimation screws on the end of the telescope tube. These three screws are to be adjusted one at a time. Normally, motions on the order of an $\frac{1}{8}$ turn will make a difference, with approximately a $\frac{1}{2}$ to $\frac{3}{4}$ turn being the maximum required.

With Polaris or a bright star centered within the field of view, focus with either the standard ocular or your highest power ocular, i.e. the shortest focal length in mm, such as a 6mm or 4mm. Another option is to use a longer focal length ocular with a Barlow lens. When a star is in focus it should look like a sharp pinpoint of light. If, when focusing on the star, it is irregular in shape or appears to have a flare of light at its edge, this means your mirrors aren't in alignment. If you notice the appearance of a flare of light from the star that remains stable in location, just as you go in and out of exact focus, then re-collimation will help sharpen the image.

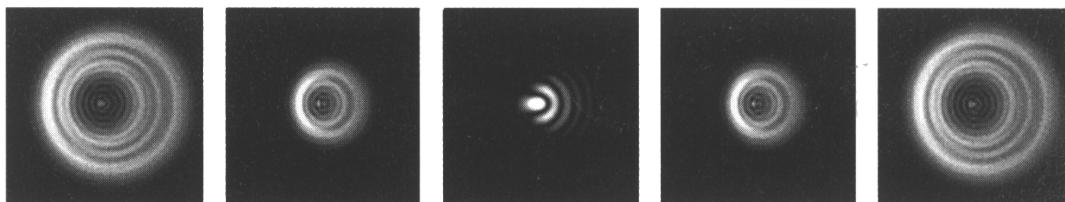

Fig 8-1 Even though the star pattern appears the same on both sides of focus, they are asymmetric. The dark obstruction is skewed off to the left side of the diffraction pattern indicating poor collimation.

Take note of the direction the light appears to flare. For example, if it appears to flare toward the three o'clock position in the field of view, then you must move whichever screw or combination of collimation screws necessary to move the star's image toward the direction of the flaring. In this example, you would want to move the image of the star in your eyepiece, by adjusting the collimation screws, toward the three o'clock position in the field of view. It may only be necessary to adjust a screw enough to move the star's image from the center of the field of view to about halfway, or less, toward the field's edge (when using a high power ocular).

Collimation adjustments are best made while viewing the star's position in the field of view and turning the adjustment screws simultaneously. This way, you can see exactly which way the movement occurs. It may be helpful to have two people working together: one viewing and instructing which screws to turn and by how much, and the other performing the adjustments.

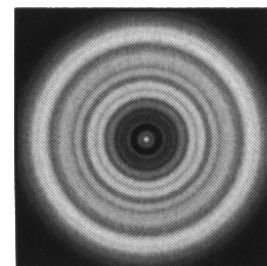

Figure 8-2
A collimated telescope should appear as a symmetrical ring pattern similar to the diffraction disk seen here.

IMPORTANT: After making the first, or each adjustment, it is necessary to re-aim the telescope tube to re-center the star again in the center of the field of view. The star image can then be judged for symmetry by going just inside and outside of exact focus and noting the star's pattern. Improvement should be seen if the proper adjustments are made. Since three screws are present, it may be necessary to move at least two of them to achieve the necessary mirror movement.

CELESTRON Optional Accessories

You will find that additional accessories enhance your viewing pleasure and expand the usefulness of your telescope. For ease of reference, all the accessories are listed in alphabetical order.

Adapter AC (#18773) - Allow DC (battery powered) telescopes to be converted for use with 120 volt AC power.

Auxiliary Port Accessory (#93965) - This accessory plugs into the auxiliary port of the telescopes control panel to provide additional ports for accessories like the CN-16 GPS as well as a PC programming port.

Barlow Lens - A Barlow lens is a negative lens that increases the focal length of a telescope. Used with any eyepiece, it doubles the magnification of that eyepiece. Celestron offers two Barlow lens in the 1-1/4" size. The 2x Ultima Barlow (#93506) is a compact triplet design that is fully multicoated for maximum light transmission and parfocal when used with the Ultima eyepieces. The OMNI Barlow (#93326) is a compact achromatic Barlow lens that is under three inches long and weighs only 4 oz. It works very well with all Celestron eyepieces.

Eyepieces - Like telescopes, eyepieces come in a variety of designs. Each design has its own advantages and disadvantages. For the 1-1/4" barrel diameter there are four different eyepiece designs available.

- **OMNI Plössl** - Plössl eyepieces have a 4-element lens designed for low-to-high power observing. The Plössls offer razor sharp views across the entire field, even at the edges! In the 1-1/4" barrel diameter, they are available in the following focal lengths: 4mm, 6mm, 9mm, 12.5mm, 15mm, 20mm, 25mm, 32mm and 40mm.
- **X-Cel** - This 6 element design allows each X-Cel Eyepiece to have 20mm of eye relief, 55° field of view and more than 25mm of lens aperture (even with the 2.3mm). In order to maintain razor sharp, color corrected images across its 55° field of view, extra-low dispersion glass is used for the most highly curved optical elements. The excellent refractive properties of these high grade optical elements, make the X-Cel line especially well suited for high magnification planetary viewing where sharp, color-free views are most appreciated. X-Cel eyepiece come in the following focal lengths: 2.3mm, 5mm, 8mm, 10mm, 12.5mm, 18mm, 21mm, 25mm.
- **Ultima** - Ultima is our 5-element, wide field eyepiece design. In the 1-1/4" barrel diameter, they are available in the following focal lengths: 5mm, 7.5mm, 10mm, 12.5mm, 18mm, 30mm, 35mm, and 42mm. These eyepieces are all parfocal. The 35mm Ultima gives the widest possible field of view with a 1-1/4" diagonal.
- **Axiom** - As an extension of the Ultima line, a new wide angle series is offered - called the Axiom series. All units are seven element designs and feature a 70° extra wide field of view (except the 50mm). All are fully multicoated and contain all the features of the Ultimas.



Filters Sets, Eyepiece - Celestron offers four convenient filter sets, which contain four different filters per set. Not only are these highly useful filter combinations, but they also offer an economical way to add versatility to your filter collection.

Series 1 - #94119-10
Orange, Light Blue, ND13%T, Polarizing (#s 21, 80A, #15, Polarizing)

Series 2 - #94119-20
Deep Yellow, Red, Light Green, ND25% T (#s 12, 25, 56, 96ND-25)

Series 3 – #94119-30
Light Red, Blue, Green, ND50% T (#s 23A, 38A, 58, 96ND-50)

Series 4 – #94119-40
Yellow, Deep Yellow, Violet, Pale Blue (#s 8, 47, 82A, 96ND-13)

Flashlight, Night Vision - (#93588) - Celestron's premium model for astronomy, using two red LED's to preserve night vision better than red filters or other devices. Brightness is adjustable. Operates on a single 9 volt battery (included).

CN16 GPS Accessory (#93963) - Plug in this 16-channel GPS module into your telescopes drive base port to link up and automatically download information from one of many global positioning satellites. Controlled with the computerized hand control, the CN-16 will greatly improve the accuracy of your star alignments.

CN16 GPS Bracket (#93964) – Support your CN-16 GPS accessory with this bracket and strap combination that securely wraps around any of the tripod legs and holds the GPS module in place .

Light Pollution Reduction (LPR) Filters (#94126A) - These filters are designed to enhance your views of deep sky astronomical objects when viewed from urban areas. LPR Filters selectively reduce the transmission of certain wavelengths of light, specifically those produced by artificial lights. This includes mercury and high and low pressure sodium vapor lights. In addition, they also block unwanted natural light (sky glow) caused by neutral oxygen emission in our atmosphere.



Micro Guide Eyepiece (#94171) - This multipurpose 12.5mm illuminated reticle can be used for guiding deep-sky astrophotos, measuring position angles, angular separations, and more. The laser etched reticle provides razor sharp lines and the variable brightness illuminator is completely cordless. The micro guide eyepiece produces 80 power with the C8-N and 96 power with the C10-N.

Moon Filter (#94119-A) - Celestron's Moon Filter is an economical eyepiece filter for reducing the brightness of the moon and improving contrast, so greater detail can be observed on the lunar surface. The clear aperture is 21mm and the transmission is about 18%.

Motor Drive, Single Axis (#93518) – This motor drive is a single axis (R.A.), DC motor drive. It is powered by four D-cell batteries (not included). 2x and 4x sidereal speeds are available through the included hand controller. For non-computerized Advanced Series Mounts.

Motor Drive, Dual Axis (#93523) - This dual axis motor drive, with drive corrector capabilities, are designed for Celestron's Advanced CG-5 mounts. They precisely control the telescope's tracking speed during long, timed exposures of celestial objects, producing the best possible image sharpness. Four speeds are available—1x (sidereal), 2x for guiding, 4x, and 8x for centering. These precision, state-of-the-art DC motor drives operate from 4 D-cell batteries (not included). The hand controller module is very compact and fits easily in the palm of your hand. Motors for both axes are included, along with brackets, clutches and hardware. For non-computerized Advanced Series Mounts.

Polarizing Filter Set (#93608) - The polarizing filter set limits the transmission of light to a specific plane, thus increasing contrast between various objects. This is used primarily for terrestrial, lunar and planetary observing.

Polar Axis Finderscope (#94220) – This useful accessory speeds accurate polar alignment by providing a means of visually aligning your German equatorial mount with Polaris and true north. As a result, you can spend more time observing and less time setting up. The finderscope has an easy to use cross hair reticle.

PowerTank (#18774) – 12v 7Amp hour rechargeable power supply. Comes with two 12v output cigarette outlets, built-in red flash light , Halogen emergency spotlight. Switchable 110v/220v AC adapter and cigarette lighter adapter included.



RS-232 Cable (#93920) – Allows your Advanced Series telescope to be controlled using a laptop computer or PC. Once connected, the telescope can be controlled using popular astronomy software programs.

Sky Maps (#93722) - Celestron Sky Maps are the ideal teaching guide for learning the night sky. You wouldn't set off on a road trip without a road map, and you don't need to try to navigate the night sky without a map either. Even if you already know your way around the major constellations, these maps can help you locate all kinds of fascinating objects.

T-Ring - The T-Ring couples your 35mm SLR camera body to the T-Adapter, radial guider, or tele-extender. This accessory is mandatory if you want to do photography through the telescope. Each camera make (i.e., Minolta, Nikon, Pentax, etc.) has its own unique mount and therefore, its own T-Ring. Celestron has 8 different models for 35mm cameras.

A full description of all Celestron accessories can be found in the Celestron Accessory Catalog (#93685)

Appendix A – Technical Specifications

Advanced Series	31061 / 31062	11047 / 11048
	C8-N	C10-N
Specifications:		
Optical Design	200mm (8.0") reflector	254mm (10") reflector
Focal Length	1000mm F/5 Parabola	1200mm F/4.7 Parabola
Finderscope	9x50	9x50
Mount	CG-5 Equatorial	CG-5 Equatorial
Eyepiece	20mm - 1.25" (50x)	20mm - 1.25" (60x)
Accessory tray	Yes	Yes
Tripod	2" Stainless Steel	2" Stainless Steel
Technical Specs		
Highest Useful Magnification	480x	600x
Lowest Useful Magnification	29x	36x
Limiting Stellar Magnitude	14	14.5
Resolution: Rayleigh	.69 arc seconds	.54 arc seconds
Dawes Limit	.58 arc seconds	.46 arc seconds
Photographic Resolution	400 line/mm	425 line/mm
Light Gathering Power	843x unaided eye	1316x unaided eye
Field of View: standard eyepiece	1°	.83°
Linear FOV (@1000 yds)	52.5 ft.	43.8 ft.
Optical Coatings - Standard	Aluminum Coating	Aluminum Coating
Secondary Mirror Obstruction	2.2"	2.3"
by Area	8%	5%
by Diameter	28%	23%
Optical tube length	37 inches	45 inches
Telescope Weight	78 lbs	93 lbs

Advanced GT	
Additional Specifications	
Hand Control	Double line, 16 character Liquid Crystal Display; 19 fiber optic backlit LED buttons
Motor: Type	DC Servo motors with encoders, both axes
Max Slew Speed	3°/second
Software Precision	24bit, 0.08 arc sec calculation
Hand Control Ports	RS-232 communication port on hand control
Motor Ports	Aux Port, Autoguide Ports
Tracking Rates	Sidereal, Solar and Lunar
Tracking Modes	EQ North & EQ South
Alignment Procedures	AutoAlign, 3-Star Alignment, Quick Align, Last Align
Database	40,000+ objects, 400 user defined programmable objects. Enhanced information on over 200 objects
Complete Revised NGC Catalog	7,840
Complete Messier Catalog	110
Complete IC Catalog	5,386
Complete Caldwell	109
Abell Galaxies	2,712
Solar System objects	9
Famous Asterisms	20
Selected CCD Imaging Objects	25
Selected SAO Stars	29,500
Total Object Database	45,492

Appendix B - Glossary of Terms

A-

Absolute magnitude	The apparent magnitude that a star would have if it were observed from a standard distance of 10 parsecs, or 32.6 light-years. The absolute magnitude of the Sun is 4.8. at a distance of 10 parsecs, it would just be visible on Earth on a clear moonless night away from surface light.
Airy disk	The apparent size of a star's disk produced even by a perfect optical system. Since the star can never be focused perfectly, 84 per cent of the light will concentrate into a single disk, and 16 per cent into a system of surrounding rings.
Alt-Azimuth Mounting	A telescope mounting using two independent rotation axis allowing movement of the instrument in Altitude and Azimuth.
Altitude	In astronomy, the altitude of a celestial object is its Angular Distance above or below the celestial horizon.
Aperture	the diameter of a telescope's primary lens or mirror; the larger the aperture, the greater the telescope's light-gathering power.
Apparent Magnitude	A measure of the relative brightness of a star or other celestial object as perceived by an observer on Earth.
Arcminute	A unit of angular size equal to 1/60 of a degree.
Arcsecond	A unit of angular size equal to 1/3,600 of a degree (or 1/60 of an arcminute).
Asterism	A small unofficial grouping of stars in the night sky.
Asteroid	A small, rocky body that orbits a star.
Astrology	The pseudoscientific belief that the positions of stars and planets exert an influence on human affairs; astrology has nothing in common with astronomy.
Astronomical unit (AU)	The distance between the Earth and the Sun. It is equal to 149,597,900 km., usually rounded off to 150,000,000 km.
Aurora	The emission of light when charged particles from the solar wind slams into and excites atoms and molecules in a planet's upper atmosphere.
Azimuth	The angular distance of an object eastwards along the horizon, measured from due north, between the astronomical meridian (the vertical line passing through the center of the sky and the north and south points on the horizon) and the vertical line containing the celestial body whose position is to be measured. .

B -

Binary Stars	Binary (Double) stars are pairs of stars that, because of their mutual gravitational attraction, orbit around a common Center of Mass. If a group of three or more stars revolve around one another, it is called a multiple system. It is believed that approximately 50 percent of all stars belong to binary or multiple systems. Systems with individual components that can be seen separately by a telescope are called visual binaries or visual multiples. The nearest "star" to our solar system, Alpha Centauri, is actually our nearest example of a multiple star system, it consists of three stars, two very similar to our Sun and one dim, small, red star orbiting around one another.
--------------	---------------------------------------------------------------------------------------------------------------------------------------------------------------------------------------------------------------------------------------------------------------------------------------------------------------------------------------------------------------------------------------------------------------------------------------------------------------------------------------------------------------------------------------------------------------------------------------------------------------------------------------------------------------------------------------------------------

C -

Celestial Equator	The projection of the Earth's equator on to the celestial sphere. It divides the sky into two equal hemispheres.
Celestial pole	The imaginary projection of Earth's rotational axis north or south pole onto the celestial sphere.
Celestial Sphere	An imaginary sphere surrounding the Earth, concentric with the Earth's center.
Collimation	The act of putting a telescope's optics into perfect alignment.

D -

Declination (DEC)	The angular distance of a celestial body north or south of the celestial equator. It may be said to correspond to latitude on the surface of the Earth.
-------------------	---------------------------------------------------------------------------------------------------------------------------------------------------------

E -

Ecliptic	The projection of the Earth's orbit on to the celestial sphere. It may also be defined as "the apparent yearly path of the Sun against the stars".
Equatorial mount	A telescope mounting in which the instrument is set upon an axis which is parallel to the axis of the Earth; the angle of the axis must be equal to the observer's latitude.

F -

Focal length	The distance between a lens (or mirror) and the point at which the image of an object at infinity is brought to focus. The focal length divided by the aperture of the mirror or lens is termed the focal ratio.
--------------	------------------------------------------------------------------------------------------------------------------------------------------------------------------------------------------------------------------

J - Jovian Planets	Any of the four gas giant planets that are at a greater distance from the sun than the terrestrial planets.
K - Kuiper Belt	A region beyond the orbit of Neptune extending to about 1000 AU which is a source of many short period comets.
L - Light-Year (LY)	A light-year is the distance light traverses in a vacuum in one year at the speed of 299,792 km/ sec. With 31,557,600 seconds in a year, the light-year equals a distance of 9.46 X 1 trillion km (5.87 X 1 trillion mi).
M - Magnitude	Magnitude is a measure of the brightness of a celestial body. The brightest stars are assigned magnitude 1 and those increasingly fainter from 2 down to magnitude 5. The faintest star that can be seen without a telescope is about magnitude 6. Each magnitude step corresponds to a ratio of 2.5 in brightness. Thus a star of magnitude 1 is 2.5 times brighter than a star of magnitude 2, and 100 times brighter than a magnitude 5 star. The brightest star, Sirius, has an apparent magnitude of -1.6, the full moon is -12.7, and the Sun's brightness, expressed on a magnitude scale, is -26.78. The zero point of the apparent magnitude scale is arbitrary.
Meridian	A reference line in the sky that starts at the North celestial pole and ends at the South celestial pole and passes through the zenith. If you are facing South, the meridian starts from your Southern horizon and passes directly overhead to the North celestial pole.
Messier	A French astronomer in the late 1700's who was primarily looking for comets. Comets are hazy diffuse objects and so Messier cataloged objects that were not comets to help his search. This catalog became the Messier Catalog, M1 through M110.
N - Nebula	Interstellar cloud of gas and dust. Also refers to any celestial object that has a cloudy appearance.
North Celestial Pole	The point in the Northern hemisphere around which all the stars appear to rotate. This is caused by the fact that the Earth is rotating on an axis that passes through the North and South celestial poles. The star Polaris lies less than a degree from this point and is therefore referred to as the "Pole Star".
Nova	Although Latin for "new" it denotes a star that suddenly becomes explosively bright at the end of its life cycle.
O - Open Cluster	One of the groupings of stars that are concentrated along the plane of the Milky Way. Most have an asymmetrical appearance and are loosely assembled. They contain from a dozen to many hundreds of stars.
P - Parallax	Parallax is the difference in the apparent position of an object against a background when viewed by an observer from two different locations. These positions and the actual position of the object form a triangle from which the apex angle (the parallax) and the distance of the object can be determined if the length of the baseline between the observing positions is known and the angular direction of the object from each position at the ends of the baseline has been measured. The traditional method in astronomy of determining the distance to a celestial object is to measure its parallax.
Parfocal	Refers to a group of eyepieces that all require the same distance from the focal plane of the telescope to be in focus. This means when you focus one parfocal eyepiece all the other parfocal eyepieces, in a particular line of eyepieces, will be in focus.
Parsec	The distance at which a star would show parallax of one second of arc. It is equal to 3.26 light-years, 206,265 astronomical units, or 30,800,000,000,000 km. (Apart from the Sun, no star lies within one parsec of us.)
Point Source	An object which cannot be resolved into an image because it is too far away or too small is considered a point source. A planet is far away but it can be resolved as a disk. Most stars cannot be resolved as disks, they are too far away.
R - Reflector	A telescope in which the light is collected by means of a mirror.
Resolution	The minimum detectable angle an optical system can detect. Because of diffraction, there is a limit to the minimum angle, resolution. The larger the aperture, the better the resolution.
Right Ascension: (RA)	The angular distance of a celestial object measured in hours, minutes, and seconds along the Celestial Equator eastward from the Vernal Equinox.
S - Schmidt Telescope	Rated the most important advance in optics in 200 years, the Schmidt telescope combines the best features of the refractor and reflector for photographic purposes. It was invented in 1930 by Bernhard Voldemar Schmidt (1879-1935).
Sidereal Rate	This is the angular speed at which the Earth is rotating. Telescope tracking motors drive the

	telescope at this rate. The rate is 15 arc seconds per second or 15 degrees per hour.
T -	
Terminator	The boundary line between the light and dark portion of the moon or a planet.
U -	
Universe	The totality of astronomical things, events, relations and energies capable of being described objectively.
V -	
Variable Star	A star whose brightness varies over time due to either inherent properties of the star or something eclipsing or obscuring the brightness of the star.
W -	
Waning Moon	The period of the moon's cycle between full and new, when its illuminated portion is decreasing.
Waxing Moon	The period of the moon's cycle between new and full, when its illuminated portion is increasing.
Z -	
Zenith	The point on the Celestial Sphere directly above the observer.
Zodiac	The zodiac is the portion of the Celestial Sphere that lies within 8 degrees on either side of the Ecliptic. The apparent paths of the Sun, the Moon, and the planets, with the exception of some portions of the path of Pluto, lie within this band. Twelve divisions, or signs, each 30 degrees in width, comprise the zodiac. These signs coincided with the zodiacal constellations about 2,000 years ago. Because of the Precession of the Earth's axis, the Vernal Equinox has moved westward by about 30 degrees since that time; the signs have moved with it and thus no longer coincide with the constellations.

APPENDIX C LONGITUDES AND LATITUDES

	LONGITUDE		LATITUDE	
	degrees	min	degrees	min
ALABAMA				
Anniston	85	51	33	34.8
Auburn	85	26.4	32	40.2
Birmingham	86	45	33	34.2
Centreville	87	15	32	54
Dothan	85	27	31	19.2
Fort Rucker	85	43.2	31	16.8
Gadsden	86	5.4	33	58.2
Huntsville	86	46.2	34	39
Maxwell AFB	86	22.2	32	22.8
Mobile	88	15	30	40.8
Mobile Aeros	88	4.2	30	37.8
Montgomery	86	2.4	32	18
Muscle Shoals	87	37.2	34	45
Selma	86	59.4	32	20.4
Troy	86	1.2	31	52.2
Tuscaloosa	87	37.2	33	13.8
ALASKA				
Anchorage	149	51	61	13.2
Barrow	156	46.8	71	18
Fairbanks	147	52.2	64	49.2
Haines Hrbor	135	25.8	59	13.8
Homer	151	3	59	37.8
Juneau	134	34.8	58	22.2
Ketchikan	131	4.2	55	21
Kodiak	152	3	57	45
Nome	165	25.8	64	30
Sitka	135	21	57	4.2
Sitkinak	154	1.2	56	52.8
Skagway	135	31.8	59	45
Valdez	146	21	61	7.8
ARIZONA				
Davis-M AFB	110	52.8	32	10.2
Deer Valley	112	4.8	33	40.8
Douglas	109	3.6	31	27
Falcon Fld	111	43.8	33	28.2
Flagstaff	111	40.2	35	7.8
Fort Huachuc	110	21	31	36
Gila Bend	113	10.2	33	33
Goodyear	112	22.8	33	25.2
GrandCanyon	112	9	35	57
Kingman	113	57	35	16.2
Luke	112	22.8	33	31.8
Page	111	27	36	55.8
Payson	111	19.8	34	13.8
Phoenix	112	1.2	33	25.8
Prescott	112	25.8	34	39
Safford Awrs	109	40.8	32	49.2
Scottsdale	111	55.2	33	37.2
Show Low	110	0	34	16.2
Tucson	110	55.8	32	7.2
Williams AFB	111	40.2	33	18
Winslow	110	43.8	35	1.2
Yuma	115	0	33	6
Yuma Mcas	114	37.2	32	39
Yuma Prv Gd	114	2.4	32	51
ARKANSAS				
Blytheville	89	57	35	58.2
Camden	92	2.4	33	31.2
El Dorado	92	4.8	33	13.2
Fayetteville	94	10.2	36	0
Ft Smith	94	22.2	35	19.8
Harrison	93	9	36	16.2
Hot Springs	93	0.6	34	28.8
Jonesboro	90	39	35	49.8
Little Rock	92	22.8	35	13.2
Pine Bluff	91	55.8	34	10.2
Springdale	94	7.8	36	10.8
Texarkana	94	0	33	27
Walnut Ridge	90	55.8	36	7.8
CALIFORNIA				
Alameda	122	19.2	37	46.8
Alturas	120	31.8	41	28.8
Arcata	124	0.6	40	58.8
Bakersfield	119	3	35	25.8
Beale AFB	121	27	39	7.8
Beaumont	116	57	33	55.8
Bicycle Lk	116	37.2	35	16.8
Big Bear	116	40.8	34	16.2
Bishop	118	3.6	37	36
Blue Canyon	120	4.2	39	16.8

	LONGITUDE		LATITUDE	
	degrees	min	degrees	min
Blythe	114	43.2	33	37.2
Burbank	118	22.2	34	12
Campo	116	28.2	32	37.2
Carlsbad	117	16.8	33	7.8
Castle AFB	120	34.2	37	22.8
Chico	121	51	39	46.8
China Lake	117	40.8	35	40.8
Chino	117	37.8	33	58.2
Concord	122	3	37	58.8
Crescent Cty	124	13.8	41	46.8
Daggett	116	46.8	34	52.2
Edwards AFB	117	52.8	34	54
El Centro	115	40.8	32	49.2
El Monte	118	1.8	34	4.8
El Toro	117	43.8	33	40.2
Eureka	124	16.8	41	19.8
Fort Hunter	121	19.2	36	0
Fort Ord	121	46.2	36	40.8
Fresno	119	43.2	36	46.2
Fullerton	117	58.2	33	52.2
George AFB	117	22.8	34	34.8
Hawthorne	118	19.8	33	55.2
Hayward	122	7.2	37	39
Imperial	115	34.2	32	49.8
Imperial Bch	117	7.2	32	34.2
La Verne	117	46.8	34	6
Lake Tahoe	120	0	38	54
Lancaster	118	13.2	34	43.8
Livermore	121	49.2	37	42
Long Beach	118	9	33	49.2
Los Alamitos	118	3	33	46.8
Los Angeles	118	2.4	33	55.8
Mammoth	118	55.2	37	37.8
March AFB	117	16.2	33	52.8
Marysville	121	34.2	39	6
Mather AFB	121	1.8	38	34.2
Mcclellan	121	2.4	38	40.2
Merced	120	31.2	37	16.8
Miramar NAS	117	9	32	52.2
Modesto	120	57	37	37.8
Moffet	122	3	37	25.2
Mojave	118	9	35	3
Montague	122	31.8	41	43.8
Monterey	121	51	36	34.8
Mount Shasta	122	19.2	41	19.2
Mount Wilson	118	4.2	34	13.8
Napa	122	16.8	38	13.2
Needles	114	37.2	34	46.2
North Is	117	1.2	32	42
Norton AFB	117	13.8	34	6
Oakland	122	13.2	37	43.8
Ontario Intl	117	37.2	34	3
Oxnard	119	1.2	34	12
Palm Springs	116	3	33	49.8
Palmdale	118	7.8	35	3
Palo Alto	122	7.2	37	28.2
Paso Robles	120	37.8	35	40.2
Pillar Pt	122	49.8	37	49.8
Point Mugu	119	7.2	34	7.2
Pt Arena	124	13.2	39	34.8
Pt Arguello	121	7.2	34	57
Pt Piedras	121	16.8	35	40.2
Red Bluff	122	15	40	9
Redding	122	1.8	40	30
Riverside	117	27	33	57
Sacramento	121	3	38	31.2
Salinas	121	3.6	36	40.2
San Carlos	122	15	37	31.2
San	117	37.2	33	25.2
Clemente				
San Diego	117	7.8	32	49.2
San	122	22.8	37	37.2
Francisco				
San Jose	121	55.2	37	22.2
San Luis Obi	120	39	35	13.8
San Mateo	117	34.8	33	22.8
San Miguel	120	2.4	34	1.8
Sandburg	118	43.8	34	45
Santa Ana	117	52.8	33	40.2
Santa Barb	119	49.8	34	25.8
Santa Maria	120	27	34	54
Santa Monica	118	27	34	1.2
Santa Rosa	122	49.2	38	31.2

	LONGITUDE		LATITUDE	
	degrees	min	degrees	min
Shelter Cove	124	4.2	40	1.8
Siskiyou	122	28.2	41	46.8
Stockton	121	15	37	54
Superior Val	117	0.6	35	19.8
Susanville	120	57	40	37.8
Thermal	116	10.2	33	37.8
Torrance	118	19.8	33	48
Travis AFB	121	55.8	38	16.2
Tahoe	120	7.8	39	19.2
Tustin Mcas	117	49.8	33	42
Ukiah	123	1.2	39	7.8
Van Nuys	118	28.8	34	13.2
Vandenberg	120	57	35	12
Visalia	119	2.4	36	19.2
COLORADO				
Air Force A	105	21	39	31.2
Akron	103	13.2	40	10.2
Alamosa	105	52.2	37	27
Aspen	106	52.2	39	13.2
Brmfield/Jef	105	7.2	39	54
Buckley	104	45	39	43.2
Colo Sprgs	104	43.2	38	49.2
Cortez	108	37.8	37	18
Craig-Moffat	107	31.8	40	30
Denver	104	52.2	39	45
Durango	107	45	37	9
Eagle	106	55.2	39	39
Englewood	104	49.8	39	34.2
Fort Carson	104	46.2	38	40.8
Fraser	105	3	39	34.2
Ft Col/Lovel	105	1.2	40	27
Ft Collins	105	4.8	40	34.8
Grand Jct	108	31.8	39	7.2
Greeley-Wild	104	37.8	40	25.8
Gunnison	106	55.8	38	33
La Junta	103	31.2	38	3
Lamar	102	3.6	38	7.2
Leadville	106	1.8	39	15
Limon	103	4.2	39	10.8
Montrose	107	52.8	38	30
Pueblo	104	31.2	38	16.8
Rifle	107	4.8	39	31.8
Salida	106	3	38	31.8
Trinidad	104	19.8	37	15
Winter Park	105	52.2	40	0
CONNECTICUT				
Bridgeport	73	7.8	41	10.2
Danbury	73	28.8	41	22.2
Groton	72	3	41	19.8
Hartford	72	39	41	43.8
New Haven	72	40.2	41	13.2
New London	72	4.8	41	18
Windsor Loc	72	40.8	41	55.8
DELAWARE				
Dover	75	28.2	39	7.8
Wilmington	75	3.6	39	40.2
D. C. WASH				
Washington	77	27.6	38	57
FLORIDA				
Apalachicola	85	1.8	29	43.8
Astor NAS	81	34.2	29	7.2
Avon Park G	81	33	28	4.8
Cape	80	33	28	28.2
Canaveral				
Cecil	81	52.8	30	13.2
Crestview	86	31.2	30	46.8
Cross City	83	0.6	29	37.2
Daytona Bch	81	3	29	10.8
Duke Fld	86	31.2	30	39
Eglin AFB	86	31.8	30	28.8
Egmont Key	82	46.2	27	36
Fort Myers	81	52.2	26	34.8
Ft Lauderdale	80	9	26	4.2
Ft Myers	81	52.2	26	39
Gainesville	82	16.2	29	40.8
Homestead	80	2		

	LONGITUDE		LATITUDE	
	degrees	min	degrees	min
Melbourne	80	37.8	28	6
Miami	80	16.8	25	49.2
Naples	81	4.8	26	7.8
Nasa Shuttle	80	40.8	28	37.2
Orlando	81	19.2	28	25.8
Panama City	85	40.8	30	12
Patrick AFB	80	3.6	28	13.8
Pensacola	87	19.2	30	21
Ruskin	82	3.6	27	58.2
Saint Peters	82	40.8	27	55.2
Sanford	81	15	28	46.8
Sarasota	82	33	27	24
Tallahassee	84	22.2	30	22.8
Tampa Intl	82	31.8	27	58.2
Titusville	80	4.8	28	31.2
Tyndall AFB	85	34.8	30	4.2
Vero Beach	80	25.2	27	39
West Palm Beach	80	7.2	26	40.8
Whiting Fld	87	1.2	30	43.2
GEORGIA				
Albany	84	10.8	31	31.8
Alma	82	31.2	31	31.8
Athens	83	19.2	33	57
Atlanta	84	25.2	33	39
Augusta/Bush	81	58.2	33	22.2
Brunswick	81	22.8	31	9
Columbus	84	55.8	32	31.2
Dobbins AFB	84	31.2	33	55.2
Fort Benning	85	0	32	19.8
Ft Stewart	81	34.2	31	52.8
Hunter Aaf	81	9	32	1.2
La Grange	85	4.2	33	0.6
Macon/Lewis	83	39	32	42
Moody AFB	83	1.2	30	58.2
Robins AFB	83	3.6	32	37.8
Rome/Russell	85	10.2	34	21
Valdosta	83	16.8	30	46.8
Waycross	82	2.4	31	15
HAWAII				
Barbers Pt	158	7.2	21	31.8
Barking San Fr Frigate	160	1.8	22	3
Hilo	155	4.2	19	43.2
Honolulu Int	157	55.8	21	21
Kahului Maui	156	25.8	20	54
Kaneohe Mca	158	16.8	21	45
Kilauea Pt	159	40.2	22	22.8
Lanai-Lanai	156	57	20	48
Lihue-Kauai	159	21	21	58.8
Maui	156	49.8	20	58.2
Molokai	157	0.6	21	9
Upolo Pt Ln	156	28.2	20	25.2
Waimea-Koha	156	7.2	20	0
IDAHO				
Boise	116	13.2	43	34.2
Burley	113	46.2	42	31.8
Challis	114	13.2	44	31.2
Coeur d'Alene	116	49.2	47	46.2
Elk City	115	25.8	45	49.2
Gooding	115	10.2	43	0
Grangeville	116	7.8	45	55.2
Idaho Falls	112	4.2	43	31.2
Lewiston	117	1.2	46	22.8
Malad City	112	19.2	42	10.2
Malta	113	22.2	42	18
Mccall	116	0.6	44	52.8
Mullan	115	4.8	47	28.2
Pocatello	112	3.6	42	55.2
Salmon	113	5.4	45	10.8
Soda Springs	111	34.8	42	39
Sun Valley	114	1.8	43	30
Twin Falls	114	28.8	42	28.8
ILLINOIS				
Alton	90	3	38	52.8
Aurora	88	19.2	41	46.2
Bistate Park	90	9	38	34.2
Bloomington	88	55.8	40	28.8
Bradford	89	3.6	41	9.6
Cairo	89	13.2	37	4.2
Carbondale	89	15	37	46.8
Centralia	89	5.4	38	30.6
Champaign	88	16.8	40	1.8
Chicago	87	39	41	54
Danville	87	3.6	40	12
DeKalb	88	43.2	41	55.8
Decatur	88	52.2	39	49.8
Du Page	88	15	41	55.2
Galesburg	90	25.8	40	55.8

	LONGITUDE		LATITUDE	
	degrees	min	degrees	min
Glenview	87	49.2	42	4.8
NAS				
Kankakee	87	51	41	4.2
Macomb	90	39.6	40	31.2
Marion	89	0	37	45
Marseilles	88	40.8	41	22.2
Mattoon	88	16.8	39	28.8
Moline/Quad	90	31.2	41	27
Mount Vernon	88	51.6	38	19.2
Peoria	89	40.8	40	40.2
Quincy	91	1.2	39	55.8
Rockford	89	0.6	42	12
Salem	88	57.6	38	37.8
Scott AFB	89	51	38	33
Springfield	89	40.2	39	51
Sterling	89	40.2	41	44.4
Taylorville	89	19.8	39	31.8
Vandalia	89	10.2	38	59.4
INDIANA				
Bakalar	86	3	39	22.8
Bloomington	86	37.2	39	7.8
Elkhart	86	0	41	43.2
Evansville	87	31.8	38	3
Fort Wayne	85	1.2	41	0
Gary	87	25.2	41	37.2
Grissom AFB	86	9	40	39
Indianapolis	86	16.2	39	43.8
Muncie	85	22.8	40	13.8
South Bend	86	19.2	41	42
Terre Haute	87	1.8	39	27
W Lafayette	86	55.8	40	25.2
IOWA				
Burlington	91	7.2	40	46.8
Cedar Rapids	91	4.2	41	52.8
Des Moines	93	39	41	31.8
Dubuque	90	4.2	42	24
Estherville	94	45	43	24
Fort Dodge	94	10.8	42	33
Lamoni	93	55.8	40	37.2
Mason City	93	19.8	43	9
Ottumwa	92	27	41	6
Sioux City	96	22.8	42	24
Spencer	95	9	43	10.2
Waterloo Mun	92	2.4	42	33
KANSAS				
Chanute	95	28.8	37	40.2
Col. J Jabar	97	13.2	37	45
Concordia	97	39	39	33
Dodge City	99	58.2	37	46.2
Elkhart	101	52.8	37	0
Emporia	96	1.2	38	19.8
Ft Leavenwrth	94	55.2	39	22.2
Ft Riley	96	46.2	39	3
Garden City	100	43.2	37	55.8
Goodland	101	4.2	39	22.2
Hays	99	16.2	38	51
Hill City	99	49.8	39	22.8
Hutchinson	97	52.2	38	4.2
Johnson Cnty	94	52.8	38	49.2
Liberal	100	58.2	37	3
Manhattan	96	40.2	39	9
Mcconnell Af	97	16.2	37	37.2
Medicine Ldg	98	34.8	37	18
Olathe	94	5.4	38	51
Russell	98	49.2	38	52.2
Salina	97	39	38	48
Topeka	95	37.2	39	4.2
Topeka/Forbe	95	40.2	38	57
Wichita	97	25.8	37	39
KENTUCKY				
Bowling Gren	86	25.8	36	58.2
Ft Campbell	87	3	36	40.2
Ft Knox	85	58.2	37	54
Jackson	83	19.2	37	36
Lexington	85	0	38	3
London	84	4.2	37	4.8
Louisville	85	40.2	38	13.8
Owensboro	87	10.2	37	45
Paducah	88	46.2	37	4.2
Pikeville	82	31.2	37	28.8
LOUISIANA				
Alexandria	92	1.8	31	22.8
Barksdale	93	40.2	32	30
Baton Rouge	91	9	30	31.8
Boothville	89	40.2	29	33
Cameron Heli	93	1.8	29	46.8
Claiborne R	92	57	31	13.2
England AFB	92	33	31	19.8
Eugene Is.	91	46.8	28	28.2
Fort Polk	93	1.2	31	3

	LONGITUDE		LATITUDE	
	degrees	min	degrees	min
Grand Isle	90	4.2	29	10.8
High Island	94	2.4	28	7.8
Houma	90	39	29	34.2
Intercoastal	92	7.2	29	43.8
Lafayette	92	0	30	12
Lake Charles	93	13.2	30	7.2
Lk Palourde	91	0.6	29	42
Missippi Can	89	3	28	46.8
Monroe	92	3	32	31.2
Morgan City	91	1.2	29	42
New Iberia	91	52.8	30	1.8
New Orleans	90	15	29	58.8
S Marsh Isl	91	58.8	28	18
Shreveport	93	45	32	31.2
Slidel	89	49.2	30	21
MAINE				
Augusta	69	4.8	44	19.2
Bangor	68	49.2	44	48
Bar Harbor	68	22.2	44	27
Brunswick	69	55.8	43	52.8
Caribou Mun	68	1.2	46	52.2
Greenville	69	33	45	27
Houlton	67	46.8	46	7.8
Loring AFB	67	52.8	46	57
Portland	70	19.2	43	39
Presque Isle	68	3	46	40.8
Rockland	69	7.2	44	4.2
Rumford	70	52.8	44	52.8
MARYLAND				
Andrews AFB	76	52.2	38	49.2
Baltimore	76	40.2	39	10.8
Fort Meade	76	46.2	39	4.8
Hagerstown	77	43.2	39	42
Ocean City	75	7.8	38	33
Patuxent	76	2.4	38	16.8
Phillips	76	10.2	39	28.2
Salisbury	75	3	38	19.8
MASSACHUSETTS				
Bedford	71	16.8	42	28.2
Beverly	70	55.2	42	34.8
Boston	71	1.8	42	22.2
Cape Cod	70	3	41	46.8
Chatham	69	58.2	41	40.2
Fort Devens	71	3.6	42	34.2
Hyannis	70	16.8	41	40.2
Lawrence	71	7.2	42	43.2
Marthas Vine	70	37.2	41	24
Nantucket	70	4.2	41	15
New Bedford	70	58.2	41	40.8
Norwood	71	10.8	42	10.8
Otis ANGB	70	31.2	41	39
Pittsfield	73	10.8	42	15.6
S Weymouth	70	55.8	42	9
Westfield	72	43.2	42	10.2
Westover	72	31.8	42	12
Worcester	71	52.2	42	16.2
MICHIGAN				
Alpena	83	34.2	45	4.2
Ann Arbor	83	45	42	13.2
Battle Creek	85	13.8	42	18
Benton Harbor	86	25.8	42	7.8
Chippewa	84	28.2	46	15
Coopersville	85	57	43	4.2
Copper Harb	87	51	47	28.2
Detroit	83	1.2	42	25.2
Escanaba	87	4.8	45	43.8
Flint/Bishop	83	45	42	58.2
Grand Rapids	85	31.2	42	52.8
Hancock	88	3	47	10.2
Harbor Beach	82	31.8	43	49.8
Houghton Lake	84	40.8	44	22.2
Iron Mtn	88	7.2	45	49.2
Ironwood	90	7.8	46	31.8
Jackson	84	28.2	42	16.2
Kalamazoo	85	33	42	13.8
Lansing	84	3.6	42	46.2
Manistee	86	15	44	16.2
Marquette	87	57	46	52.8
Menominee	87	37.8	45	7.2
Muskegon	86	15	43	10.2
Pellston	84	4.8	45	34.2
Pontiac	83	25.2	42	40.2
Saginaw	84	4.8	43	31.8
Sault Ste M	84	22.2	46	28.2
Sawyer AFB	87	2.4	46	21
Selfridge	82	49.8	42	37.2
Seul Choix	85	55.2	45	55.2
Traverse City	85	34.8	44	43.8

	LONGITUDE		LATITUDE	
	degrees	min	degrees	min
Wurtsmith	83	2.4	44	27
Ypsilanti	83	31.8	42	13.8
MINNESOTA				
Albert Lea	93	22.2	43	40.8
Alexandria	95	22.8	45	52.2
Bemidji Muni	94	55.8	47	30
Brainerd-Crw	94	7.8	46	24
Detroit Laks	95	52.8	46	49.2
Duluth	92	10.8	46	49.8
Ely	91	49.2	47	54
Fairmont	94	25.2	43	39
Fergus Falls	96	4.2	46	18
Grand Rapids	93	31.2	47	13.2
Hibbing	92	51	47	22.8
Intl Falls	93	22.8	48	34.2
Litchfield	94	31.2	45	7.8
Mankato	93	55.2	44	13.2
Marshall Arpt	95	49.2	44	27
Minneapolis	93	28.2	44	49.8
Park Rapids	95	4.2	46	54
Pequot Lake	94	19.2	46	36
Rochester	92	3	43	55.2
Saint Paul	93	3	44	55.8
St Cloud	94	4.2	45	33
Thief River	96	10.8	48	4.2
Tofte	90	49.8	47	34.8
Warroad	95	21	48	55.8
Worthington	95	34.8	43	39
MISSISSIPPI				
Columbus	88	27	33	39
AFB				
Golden Trian	88	34.8	33	27
Greenville	90	58.8	33	28.8
Greenwood	90	4.8	33	30
Gulfport	89	4.2	30	24
Hattiesburg	89	19.8	31	28.2
Jackson	90	4.8	32	19.2
Keesler AFB	88	55.2	30	25.2
Laurel	89	10.2	31	40.2
Mccomb	90	28.2	31	10.8
Meridian NAS	88	34.2	32	33
Meridian/Key	88	45	32	19.8
Natchez	91	15	31	37.2
Oxford	89	32.4	34	23.4
Tupelo	88	46.2	34	16.2
MISSOURI				
Columbia	92	13.2	38	49.2
Cape	89	34.8	37	13.8
Girardeau				
Ft Leonard	92	7.8	37	45
Jefferson City	92	10.2	38	36
Joplin	94	3	37	10.2
Kansas City	94	43.2	39	19.2
Kirksville	92	33	40	6
Monett	94	21	37	19.8
Muskogee	95	21.6	35	39.6
Poplar Bluff	90	28.2	36	46.2
Richards-Geb	94	33	38	51
Spickard	93	43.2	40	15
Springfield	93	22.8	37	13.8
St Joseph	95	31.8	40	16.8
St Louis	90	22.2	38	45
Vichy/Rolla	91	46.2	38	7.8
West Plains	92	25.2	37	13.2
Whiteman	93	33	38	43.8
AFB				
MONTANA				
Billings	108	31.8	45	48
Bozeman	111	9	45	46.8
Broadus	105	40.2	45	40.2
Butte	112	3	45	57
Cut Bank	112	22.2	48	36
Dillon	112	33	45	15
Drummond	113	9	46	40.2
Glasgow	106	37.2	48	13.2
Glendive	104	4.8	47	7.8
Great Falls	111	22.2	47	28.8
Harlowton	109	49.8	46	25.8
Havre	109	46.2	48	33
Helena	112	0	46	36
Jordan	106	55.8	47	19.8
Kalispell	114	16.2	48	18
Lewiston	109	27	47	3
Livingston	110	25.8	45	42
Malmstrom	111	10.8	47	30
Miles City	105	52.2	46	25.8
Missoula	114	4.8	46	55.2
Monida	112	19.2	44	34.2
Sidney	104	10.8	47	43.2
W Yellowstone	111	0.6	44	39

	LONGITUDE		LATITUDE	
	degrees	min	degrees	min
NEBRASKA				
Ainsworth	99	58.8	42	34.8
Alliance	102	4.8	42	3
Beatrice	96	45	40	19.2
Broken Bow	99	39	41	25.8
Burwell	99	9	41	46.8
Chadron	103	4.8	42	49.8
Columbus	97	21	41	27
Cozad	100	0	40	52.2
Falls City	95	34.8	40	4.2
Grand Island	98	19.2	40	58.2
Hastings	98	25.8	40	36
Imperial	101	23.4	40	19.8
Kearney	99	0	40	43.8
Lincoln Muni	96	45	40	51
Mccook	100	34.8	40	13.2
Mullen	101	3	42	3
Norfolk	97	25.8	41	58.8
North Omaha	96	1.2	41	22.2
North Platte	100	40.8	41	7.8
O'neill	98	40.8	42	28.2
Offutt AFB	95	55.2	41	7.2
Omaha	95	5.4	41	18
Ord/Sharp	98	57	41	37.2
Scottsbluff	103	3.6	41	52.2
Sidney Muni	102	58.8	41	6
Valentine	100	33	42	52.2
NEVADA				
Austin	117	7.8	39	49.8
Battle Mtn	116	52.2	40	37.2
Caliente	114	31.2	37	37.2
Elko	115	46.8	40	49.8
Ely/Yelland	114	51	39	16.8
Eureka	115	58.2	39	30
Fallon NAS	118	4.2	39	25.2
Hawthorne	118	37.8	38	33
Ind Sprng Rn	115	34.2	36	31.8
Las Vegas	115	10.2	36	4.8
Lovelock	118	55.2	40	6
Mercury	116	1.2	36	37.2
Nellis AFB	115	1.8	36	13.8
Owyhee	116	10.2	42	34.8
Reno	119	46.8	39	30
Tonopah	117	4.8	38	4.2
Wildhorse	116	15	41	19.8
Winnemucca	117	4.8	40	54
Yucca Flat	116	4.8	37	34.8
NEW HAMPSHIRE				
Berlin	71	10.8	44	34.8
Concord	71	3	43	12
Jaffrey	72	0	42	48
Keene	72	16.2	42	54
Laconia	71	25.8	43	34.2
Lebanon	72	1.8	43	37.8
Manchester	71	25.8	42	55.8
Mt Washington	71	1.8	44	16.2
Nashua	71	31.2	42	46.8
Pease AFB	70	49.2	43	4.8
Wolfeboro	71	22.8	44	0
NEW JERSEY				
Atlantic Ctly	74	34.2	39	27
Barnegat Ls	74	16.8	40	16.8
Fairfield	74	16.8	40	52.2
Lakehurst	74	21	40	1.8
Mcguire AFB	74	3.6	40	1.2
Millville	75	4.2	39	22.2
Morristown	74	25.2	40	48
Newark Intl	74	10.2	40	42
Teterboro	74	3	40	51
Trenton	74	49.2	40	16.8
NEW MEXICO				
Albuquerque	106	3.6	35	3
Cannon	103	19.2	34	22.8
Carlsbad	104	16.2	32	19.8
Clayton Arpt	103	9	36	27
Corona	105	40.8	34	6
Deming	107	4.2	32	15
Farmington	108	13.8	36	45
Gallup/Clark	108	46.8	35	31.2
Grants	107	5.4	35	10.2
Hobbs	103	1.2	32	40.8
Holloman	106	0.6	32	51
AFB				
Las Cruces	106	46.2	32	18
Las Vegas	105	9	35	39
Los Alamos	106	16.8	35	52.8
Moriarty	106	3	34	58.8
Northrup Str	106	2.4	32	54
Raton	104	3	36	44.4
Roswell	104	31.8	33	18

	LONGITUDE		LATITUDE	
	degrees	min	degrees	min
Santa Fe	106	4.8	35	37.2
Silver City	108	10.2	32	37.8
Socorro	106	5.4	34	4.2
Taos	105	34.2	36	25.2
Truth Or Con	107	16.2	33	13.8
Tucumcari	103	3.6	35	10.8
White Sands	106	2.4	32	37.8
NEW YORK				
Albany	73	4.8	42	45
Ambrose	74	22.2	40	45
Binghamton	75	58.8	42	13.2
Buffalo	78	43.8	42	55.8
Dansville	78	1.2	42	58.2
Elmira	76	5.4	42	10.2
Farmingdale	73	25.8	40	43.8
Fort Drum	75	43.8	44	3
Glens Falls	73	37.2	43	21
Griffiss AFB	75	2.4	43	13.8
Islip	73	0.6	40	46.8
Ithaca	76	28.2	42	28.8
Jamestown	79	15	42	9
Massena	74	51	44	55.8
Monticello	74	4.8	41	42
New York	73	58.8	40	46.2
Newburgh	74	0.6	41	30
Niagara Fall	78	57	43	6
Ogdensburg	75	2.4	44	40.8
Oneonta	75	7.2	42	52.2
Plattsburgh	73	28.2	44	39
Rochester	77	40.2	43	7.2
Saranac Lk	74	1.2	44	22.8
Schenectady	73	55.8	42	51
Syracuse	76	7.2	43	7.2
Utica	75	22.8	43	9
Watertown	76	1.2	44	0
Westhampton	72	37.8	40	51
White Plains	73	43.2	41	4.2
NORTH CAROLINA				
Asheville	82	33	35	25.8
Cape Hattera	75	33	35	16.2
Charlotte	80	55.8	35	13.2
Cherry Point	76	52.8	34	54
Dare Co Gr	76	3	36	7.8
Diamond Sho	75	3	35	15
Elizabeth	76	10.8	36	16.2
Fayetteville	78	52.8	35	0
Fort Bragg	78	55.8	35	7.8
Greensboro	79	57	36	4.8
Hickory	81	22.8	35	45
Hot Springs	82	49.2	35	54
Jacksonville	77	37.2	34	49.2
Kinston	77	37.8	35	19.2
Mackall Aaf	79	3	35	1.8
Manteo Arpt	75	40.8	35	55.2
New Bern	77	3	35	4.8
New River	77	25.8	34	42
Pope AFB	79	1.2	35	10.2
Raleigh-Durh	78	46.8	35	52.2
Rocky Mt	77	52.8	35	51
Southern Pin	79	23.4	35	14.4
Wilmington	77	55.2	34	16.2
Winston-Salem	80	13.8	36	7.8
NORTH DAKOTA				
Bismarck	100	45	46	46.2
Devil's Lake	98	5.4	48	7.2
Dickenson	102	4.8	46	46.8
Fargo	96	4.8	46	54
Grand Fork				

	LONGITUDE		LATITUDE	
	degrees	min	degrees	min
OKLAHOMA				
Altus AFB	99	16.2	34	40.2
Ardmore	97	1.2	34	18
Bartlesville	96	0	36	45
Clinton	99	1.2	35	21
Enid	97	4.8	36	22.8
Fort Sill	98	2.4	34	39
Gage	99	46.2	36	18
Hobart	99	3	35	0
Lawton	98	25.2	34	34.2
Mcalester	95	46.8	34	52.8
Norman	97	28.2	35	13.8
Oklahoma	97	3.6	35	24
Page	94	37.2	34	40.8
Ponca City	97	0.6	36	43.8
Stillwater	97	5.4	36	9.6
Tinker AFB	97	22.8	35	25.2
Tulsa	95	5.4	36	12
Vance AFB	97	55.2	36	19.8
OREGON				
Astoria	123	52.8	46	9
Aurora	122	45	45	15
Baker	117	49.2	44	49.8
Brookings	124	28.2	42	4.8
Burns Arpt	118	57	43	36
Cape Blanco	124	57	43	22.8
Cascade	121	52.8	45	40.8
Corvallis	123	16.8	44	30
Eugene	123	13.2	44	7.2
Hillsboro	122	57	45	31.8
Klamath Fall	121	43.8	42	9
La Grande	118	0	45	16.8
Lake View	120	21	42	10.8
Meacham	118	2.4	45	30
Medford	122	52.2	42	22.2
Newport	124	3	44	37.8
North Bend	124	15	43	25.2
Ontario	117	1.2	44	1.2
Pendleton	118	51	45	40.8
Portland	122	3.6	45	36
Redmond	121	9	44	16.2
Roseburg	123	22.2	43	13.8
Salem	123	0	44	55.2
Sexton	123	22.2	42	37.2
The Dalles	121	9	45	37.2
Troutdale	122	2.4	45	33
PENNSYLVANIA				
Allentown	75	25.8	40	39
Altoona	78	19.2	40	18
Beaver Falls	80	19.8	40	45
Blairsville	79	5.4	40	16.2
Bradford	78	37.8	41	48
Dubois	78	5.4	41	10.8
Erie	80	10.8	42	4.8
Franklin	79	52.2	41	22.8
Harrisburg	76	51	40	13.2
Johnstown	78	49.8	40	19.2
Lancaster	76	1.8	40	7.8
Latrobe	79	2.4	40	16.8
Middletown	76	46.2	40	12
Muir	76	34.2	40	25.8
Nth Philadel	75	1.2	40	4.8
Philadelphia	75	15	39	52.8
Philipsburg	78	7.8	41	28.2
Pittsburgh	79	55.8	40	21
Reading	75	58.2	40	22.8
Site R	77	25.8	39	43.8
State Colleg	77	49.8	40	51
Wilkes-Barre	75	43.8	41	19.8
Williamsport	76	55.2	41	15
Willow Grove	75	9	40	12
RHODE ISLAND				
Block Island	71	34.8	41	10.2
Nth Kingston	71	25.2	41	36
Providence	71	25.8	41	43.8
SOUTH CAROLINA				
Anderson	82	43.2	34	30
Beaufort	80	43.2	32	28.8
Charleston	80	1.8	32	54
Columbia	81	7.2	33	57
Florence	79	43.2	34	10.8
Greenville	82	21	34	51
Mcentire	80	4.8	33	55.2

	LONGITUDE		LATITUDE	
	degrees	min	degrees	min
Myrtle Beach	78	55.8	33	40.8
Shaw AFB	80	28.2	33	58.2
Spartanburg	81	57.6	34	55.2
SOUTH DAKOTA				
Aberdeen	98	25.8	45	27
Brookings	96	4.8	44	18
Chamberlain	99	19.2	43	48
Custer	103	3.6	43	46.2
Ellsworth	103	0.6	44	9
Huron	98	13.2	44	22.8
Lemmon	102	10.2	45	55.8
Mitchell	98	1.8	43	46.2
Mobridge	100	25.8	45	31.8
Philip	101	3.6	44	3
Pierre	100	16.8	44	22.8
Rapid City	103	4.2	44	3
Redig	103	19.2	45	9.6
Sioux Falls	96	43.8	43	34.8
Watertown	97	9	44	55.2
Yankton	97	22.8	42	55.2
TENNESSEE				
Bristol	82	2.4	36	28.8
Chattanooga	85	1.2	35	1.8
Clarksville	87	25.2	36	37.2
Crossville	85	4.8	35	57
Dyersburg	89	2.4	36	1.2
Jackson	88	55.2	35	36
Knoxville	83	58.8	35	49.2
Memphis Intl	90	0	35	3
Monteagle	85	30.6	35	9
Nashville	86	40.8	36	7.2
Smyrna	86	3	36	0
TEXAS				
Abilene	99	40.8	32	25.2
Alice	98	1.8	27	43.8
Amarillo	101	4.2	35	13.8
Austin	97	4.2	30	18
Bergstrom Af	97	40.8	30	12
Big Sky	101	28.8	32	23.4
Big Spring	101	27	32	18
Brownsville	97	25.8	25	54
Brownwood	98	57.6	31	47.4
Carswell AFB	97	25.8	32	46.8
Chase NAS	97	40.2	28	22.2
Childress	100	16.8	34	25.8
College Stn	96	22.2	30	34.8
Corpus Chrst	97	3	27	46.2
Cotulla	99	13.2	28	27
Dalhart	102	33	36	1.2
Dallas/FW	97	1.8	32	54
Del Rio	100	55.2	29	22.2
Dyess AFB	99	51	32	25.8
El Paso	106	2.4	31	48
Ellington Af	95	10.2	29	37.2
Fort Worth	97	21	32	49.2
Ft Hood Aaf	97	43.2	31	9
Galveston	94	52.2	29	16.2
Gray AFB	97	49.8	31	4.2
Greenville	96	4.2	33	4.2
Guadalupe	104	4.8	31	49.8
Harlingen	97	40.2	26	13.8
Hondo	99	10.2	29	21
Houston	95	21	29	58.2
Junction	99	46.2	30	30
Kelly AFB	98	34.8	29	22.8
Kerrville	99	4.8	29	58.8
Killeen	97	40.8	31	4.8
Kingsville	97	49.2	27	30
Laredo Intl	99	28.2	27	31.8
Laughlin AFB	100	46.8	29	22.2
Longview	94	43.2	32	22.8
Lubbock	101	49.2	33	39
Lufkin	94	45	31	13.8
Marfa	104	1.2	30	22.2
Mcallen	98	13.8	26	10.8
Midland	102	10.8	31	57
Mineral Wils	98	4.2	32	46.8
Palacios	96	15	28	43.2
Paris/Cox	95	27	33	37.8
Plainview	101	42.6	34	10.2
Port Arthur	94	1.2	30	34.8
Reese AFB	102	3	33	36
Rockport	97	1.8	28	4.8

	LONGITUDE		LATITUDE	
	degrees	min	degrees	min
San Angelo	100	3	31	22.2
San Antonio	98	28.2	29	31.8
Sanderson	102	25.2	30	10.2
South Brazos	95	52.2	28	1.8
Stephenville	98	10.8	32	13.2
Temple	97	25.2	31	9
Tyler/Pounds	95	2.4	32	22.2
Victoria	96	55.2	28	51
Wichita Fils	98	3	33	58.8
Wink	103	1.2	31	46.8
UTAH				
Blanding	109	46.8	38	1.8
Bullfrog Mar	110	4.2	37	30
Cedar City	113	0.6	37	42
Delta	112	34.8	39	19.8
Eagle Range	113	4.2	41	3
Green River	110	9	39	0
Hanksville	110	43.2	38	22.2
Hill AFB	111	58.2	41	7.2
Logan	111	51	41	46.8
Milford	113	1.8	38	43.2
Moab	109	45	38	46.2
Ogden	112	1.2	41	10.8
Price/Carbon	110	45	39	37.2
Provo	111	43.2	40	13.2
Roosevelt	110	37.8	40	30
Saint George	113	3.6	37	4.8
Salt Lake Ct	111	58.2	40	46.8
Tooele	112	1.2	40	10.2
Vernal	109	31.2	40	27
Wendover	114	3	41	13.2
VERMONT				
Burlington	73	9	44	28.2
Montpelier	72	34.2	44	12
Newport	72	19.8	45	33
Rutland	73	57	43	31.8
St Johnsbury	72	1.2	44	25.2
Wilmington	72	52.8	42	52.8
VIRGINIA				
Charlottes	78	27	38	7.8
Chesapeake	76	1.2	37	30
Danville	79	19.8	36	34.2
Fort Belvoir	77	10.8	38	43.2
Fort Eustis	76	37.2	37	7.8
Hot Springs	79	49.2	37	57
Langley AFB	76	22.2	37	4.8
Lynchburg	79	1.2	37	19.8
Newport	76	3	37	7.8
News				
Norfolk NAS	76	16.8	36	55.8
Norfolk Rgnl	76	1.2	36	54
Oceana NAS	76	1.8	36	49.2
Quantico Mca	77	1.8	38	30
Richmond	77	19.8	37	30
Roanoke	79	58.2	37	19.2
Muni				
Staunton	78	51	38	16.2
Volens	78	58.8	36	57
Wallops Sta	75	28.8	37	51
WASHINGTON				
Bellingham	122	31.8	48	48
Bremerton	122	46.2	47	28.8
Burlington	122	19.8	48	30
Colville	118	28.2	48	52.8
Ephrata	119	31.2	47	19.2
Everet/Paine	122	16.8	47	55.2
Fairchild	117	39	47	37.2
Fort Lewis	122	34.8	47	4.8
Hanford	119	3.6	46	34.2
Hoquiam	123	58.2	46	58.2
Mchord AFB	122	28.8	47	9
Moses Lake	119	19.2	47	12
Oak Harbor	122	40.8	48	15
Olympia	122	5.4	46	58.2
Omak	119	31.8	48	25.2
Pasco	119	7.2	46	16.2
Port Angeles	123	3	48	7.2
Pullman	117	7.2	46	45
Quillayute	124	33	47	57
Renton	122	13.2	47	30
Seattle	122	1.8	47	27

	LONGITUDE		LATITUDE	
	degrees	min	degrees	min
Walla Walla	118	16.8	46	6
Wenatchee	120	1.2	47	24
Whidbey Is	122	39	48	21
Yakima	120	31.8	46	34.2
WEST VIRGINIA				
Beckley	81	7.2	37	46.8
Bluefield	81	13.2	37	18
Charleston	81	3.6	38	22.2
Clarksburg	80	13.8	39	16.8
Elkins	79	51	38	52.8
Huntington	82	33	38	22.2
Lewisburg	80	2.4	37	52.2
Martinsburg	77	58.8	39	24
Morgantown	79	55.2	39	39
Parkersburg	81	25.8	39	21
Wheeling	80	39	40	10.8
Wh Sulphur	80	1.2	37	27.6

	LONGITUDE		LATITUDE	
	degrees	min	degrees	min
WISCONSIN				
Appleton	88	31.2	44	15
Eau Claire	91	28.8	44	52.2
Green Bay	88	7.8	44	28.8
Janesville	89	1.8	42	37.2
La Crosse	91	15	43	52.2
Lone Rock	90	10.8	43	12
Madison	89	19.8	43	7.8
Manitowac	87	40.2	44	7.8
Milwaukee	87	5.4	42	57
Mosinee	89	40.2	44	46.8
Neenah	88	31.8	44	13.2
Oshkosh	88	34.2	44	0
Rhineland	89	27	45	37.8
Rice Lake	91	43.2	45	28.8
Volk Fld	90	16.2	43	55.8
Wausau	89	37.2	44	55.2

	LONGITUDE		LATITUDE	
	degrees	min	degrees	min
WYOMING				
Big Piney	110	0.6	42	34.2
Casper	106	28.2	42	55.2
Cheyenne	104	49.2	41	9
Cody	109	1.2	44	31.2
Douglas	105	22.8	42	45
Evanston	111	0	41	19.8
Gillette	105	31.8	44	21
Jackson	110	43.8	43	36
Lander	108	43.8	42	49.2
Laramie	105	40.8	41	19.2
Moorcroft	104	48.6	44	21
Rawlins	107	1.2	41	48
Riverton	108	27	43	3
Rock Springs	109	4.2	41	36
Sheridan	106	58.2	44	46.2
Worland	107	58.2	43	58.2
Yellowstone	110	25.2	44	33

CANADA

CITY	PROVINCE	LONGITUDE	LATITUDE
Calgary	Alberta	114 7	51 14
Churhill	Newfoundland	94 0	58 45
Coppermine	Northwest Terr.	115 21	67 49
Edmonton	Alberta	113 25	53 34
Frederickton	New Brunswick	66 40	45 57
Ft Mcpherson	Northwest Terr	134 50	67 29
Goose Bay	Newfoundland	60 20	53 15
Halifax	Nova Scotia	63 34	44 39
Hazelton	BC	127 38	55 15
Kenora	Ontario	94 29	49 47
Labrador City	Labrador	66 52	52 56
Montreal	Quebec	73 39	45 32
Mt. Logan	Yukon	140 24	60 34
Nakina	Yukon	132 48	59 12
Ottawa	Ontario	75 45	45 18
Peace River	Alberta	117 18	56 15
Pr. Edward Isl	Nova Scotia	63 9	46 14
Quebec	Quebec	71 15	46 50
Regina	Saskatchewan	104 38	50 30
Saskatoon	Saskatchewan	101 32	52 10
St. Johns	Newfoundland	52 43	47 34
Toronto	Ontario	79 23	43 39
Vancouver	BC	123 7	49 16
Victoria	BC	123 20	48 26
Whitehorse	Yukon	135 3	60 43
Winnipeg	Manitoba	97 9	49 53

CITY	COUNTRY	LONGITUDE	LATITUDE
Glasgow	Scotland	4 15 w	55 50 n
Guatemala City	Guatemala	90 31 w	14 37 n
Guayaquil	Ecuador	79 56 w	2 10 s
Hamburg	Germany	10 2 e	53 33 n
Hammerfest	Norway	23 38 e	70 38 n
Havana	Cuba	82 23 w	23 8 n
Helsinki	Finland	25 0 e	60 10 n
Hobart	Tasmania	147 19 e	42 52 s
Iquique	Chile	70 7 w	20 10 s
Irkutsk	Russia	104 20 e	52 30 n
Jakarta	Indonesia	106 48 e	6 16 s
Johannesburg	South Africa	28 4 e	26 12 s
Kingston	Jamaica	76 49 w	17 59 n
La Paz	Bolivia	68 22 w	16 27 s
Leeds	England	1 30 w	53 45 n
Lima	Peru	77 2 w	12 0 s
Liverpool	England	3 0 w	53 25 n
London	England	0 5 w	51 32 n
Lyons	France	4 50 e	45 45 n
Madrid	Spain	3 42 w	40 26 n
Manchester	England	2 15 w	53 30 n
Manila	Philippines	120 57 e	14 35 n
Marseilles	France	5 20 e	43 20 n
Mazatlán	Mexico	106 25 w	23 12 n
Mecca	Saudi Arabia	39 45 e	21 29 n
Melbourne	Australia	144 58 e	37 47 s
Mexico City	Mexico	99 7 w	19 26 n
Milan	Italy	9 10 e	45 27 n
Montevideo	Uruguay	56 10 w	34 53 s
Moscow	Russia	37 36 e	55 45 n
Munich	Germany	11 35 e	48 8 n
Nagasaki	Japan	129 57 e	32 48 n
Nagoya	Japan	136 56 e	35 7 n
Nairobi	Kenya	36 55 e	1 25 s
Nanjing	China	118 53 e	32 3 n
Naples	Italy	14 15 e	40 50 n
Newcastle	England	1 37 w	54 58 n
Odessa	Ukraine	30 48 e	46 27 n
Osaka	Japan	135 30 e	34 32 n
Oslo	Norway	10 42 e	59 57 n
Panama City	Panama	79 32 w	8 58 n
Paramaribo	Surinam	55 15 w	5 45 n
Paris	France	2 20 e	48 48 n
Beijing	China	116 25 e	39 55 n
Perth	Australia	115 52 e	31 57 s
Plymouth	England	4 5 w	50 25 n
Rio de Janeiro	Brazil	43 12 w	22 57 s
Rome	Italy	12 27 e	41 54 n
Salvador	Brazil	38 27 w	12 56 s
Santiago	Chile	70 45 w	33 28 s
St. Petersburg	Russia	30 18 e	59 56 n
Sao Paulo	Brazil	46 31 w	23 31 s
Shanghai	China	121 28 e	31 10 n
Sofia	Bulgaria	23 20 e	42 40 n
Stockholm	Sweden	18 3 e	59 17 n
Sydney	Australia	151 0 e	34 0 s
Tananarive	Madagascar	47 33 e	18 50 s
Teheran	Iran	51 45 e	35 45 n
Tokyo	Japan	139 45 e	35 40 n
Tripoli	Libya	13 12 e	32 57 n
Venice	Italy	12 20 e	45 26 n
Veracruz	Mexico	96 10 w	19 10 n
Vienna	Austria	16 20 e	48 14 n
Warsaw	Poland	21 0 e	52 14 n
Wellington	New Zealand	174 47 e	41 17 s
Zürich	Switzerland	8 31 e	47 21 n

INTERNATIONAL

Aberdeen	Scotland	2 9 w	57 9 n
Adelaide	Australia	138 36 e	34 55 s
Amsterdam	Holland	4 53 e	52 22 n
Ankara	Turkey	32 55 e	39 55 n
Asunción	Paraguay	57 40 w	25 15 s
Athens	Greece	23 43 e	37 58 n
Auckland	New Zealand	174 45 e	36 52 s
Bangkok	Thailand	100 30 e	13 45 n
Barcelona	Spain	2 9 e	41 23 n
Belém	Brazil	48 29 w	1 28 s
Belfast	Northern Ireland	5 56 w	54 37 n
Belgrade	Yugoslavia	20 32 e	44 52 n
Berlin	Germany	13 25 e	52 30 n
Birmingham	England	1 55 w	52 25 n
Bombay	India	72 48 e	19 0 n
Bordeaux	France	0 31 w	44 50 n
Bremen	Germany	8 49 e	53 5 n
Brisbane	Australia	153 8 e	27 29 s
Bristol	England	2 35 w	51 28 n
Brussels	Belgium	4 22 e	50 52 n
Bucharest	Romania	26 7 e	44 25 n
Budapest	Hungary	19 5 e	47 30 n
Buenos Aires	Argentina	58 22 w	34 35 s
Cairo	Egypt	31 21 e	30 2 n
Canton	China	113 15 e	23 7 n
Cape Town	South Africa	18 22 e	33 55 s
Caracas	Venezuela	67 2 w	10 28 n
Chihuahua	Mexico	106 5 w	28 37 n
Chongqing	China	106 34 e	29 46 n
Copenhagen	Denmark	12 34 e	55 40 n
Córdoba	Argentina	64 10 w	31 28 s
Darwin	Australia	130 51 e	12 28 s
Dublin	Ireland	6 15 w	53 20 n
Durban	South Africa	30 53 e	29 53 s
Edinburgh	Scotland	3 10 w	55 55 n
Frankfurt	Germany	8 41 e	50 7 n
Georgetown	Guyana	58 15 w	6 45 n

Appendix D - RS-232 Connection

You can control your telescope with a computer via the RS-232 port on the computerized hand control and using an optional RS-232 cable (#93920). Once connected, the telescope can be controlled using popular astronomy software programs.

Communication Protocol:

The Advanced GT communicates at 9600 bits/sec, No parity and a stop bit. All angles are communicated with 16 bit angle and communicated using ASCII hexadecimal.

Description	PC Command ASCII	Hand Control Response	Notes
Echo	Kx	X#	Useful to check communication
Goto Azm-Alt	B12AB, 4000	#	10 characters sent. B=Command, 12AB=Azm, comma, 4000=Alt. If command conflicts with slew limits, there will be no action.
Goto Ra-Dec	R34AB, 12CE	#	Scope must be aligned. If command conflicts with slew limits, there will be no action.
Get Azm-Alt	Z	12AB, 4000#	10 characters returned, 12AB=Azm, comma, 4000=Alt, #
Get RA-Dec	E	34AB, 12CE#	Scope must be aligned
Cancel Goto	M	#	
Is Goto in Progress	L	0# or 1#	0=No, 1=Yes; "0" is ASCII character zero
Is Alignment Complete	J	0# or 1#	0=No, 1=Yes
Commands below available on version 1.6 or later			
HC version	V	22	Two bytes representing V2.2
Stop/Start Tracking	Tx x = 0 (Tracking off) x = 1 (Alt-Az on) x = 2 (EQ-N) x = 3 (EQ-S)	#	Alt-Az tracking requires alignment
32-bit goto RA-Dec	r34AB0500,12CE0500	#	
32-bit get RA-Dec	e	34AB0500,12CE0500#	The last two characters will always be zero.
Commands below available on version 2.2 or later			
32-bit goto Azm-Alt	b34AB0500,12CE0500	#	
32-bit get Azm-Alt	z	34AB0500,12CE0500#	The last two characters will always be zero.

The cable required to interface to the telescope has an RS-232 male plug at one end and a 4-4 telephone jack at the other end. The wiring is as follows:

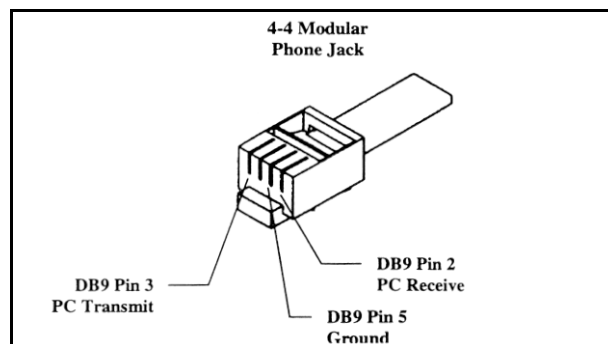

Additional RS232 Commands

Send Any Track Rate Through RS232 To The Hand Control

1. Multiply the desired tracking rate (arcseconds/second) by 4. Example: if the desired trackrate is 150 arcseconds/second, then TRACKRATE = 600
2. Separate TRACKRATE into two bytes, such that (TRACKRATE = TrackRateHigh*256 + rackRateLow). Example: TrackRateHigh = 2 TrackRateLow = 88
3. To send a tracking rate, send the following 8 bytes:
 - a. **Positive Azm tracking:** 80, 3, 16, 6, TrackRateHigh, TrackRateLow, 0, 0
 - b. **Negative Azm tracking:** 80, 3, 16, 7, TrackRateHigh, TrackRateLow, 0, 0
 - c. **Positive Alt tracking:** 80, 3, 17, 6, TrackRateHigh, TrackRateLow, 0, 0
 - d. **Negative Alt tracking:** 80, 3, 17, 7, TrackRateHigh, TrackRateLow, 0, 0
4. The number 35 is returned from the handcontrol

Send A Slow-Goto Command Through RS232 To The Hand Control

(note: Only valid for motorcontrol version 4.1 or greater)

1. Convert the angle position to a 24bit number. Example: if the desired position is 220°, then POSITION_24BIT = $(220/360)*2^{24} = 10,252,743$
2. Separate POSITION_24BIT into three bytes such that (POSITION_24BIT = PosHigh*65536 + PosMed*256 + PosLow). Exampe: PosHigh = 156, PosMed = 113, PosLow = 199
3. Send the following 8 bytes:
 - a. Azm Slow Goto: 80, 4, 16, 23, PosHigh, PosMed, PosLow, 0
 - b. Alt Slow Goto: 80, 4, 17, 23, PosHigh, PosMed, PosLow, 0
4. The number 35 is returned from the handcontrol

Reset The Position Of Azm Or Alt

1. Convert the angle position to a 24bit number, same as Slow-Goto example.
2. Send the following 8 bytes:
 - a. Azm Set Position: 80, 4, 16, 4, PosHigh, PosMed, PosLow, 0
 - b. Alt Set Position: 80, 4, 17, 4, PosHigh, PosMed, PosLow, 0
3. The number 35 is returned from the handcontrol
4. Note: If using Motorcontrol version less than 4.1, then send:
 - a. Azm Set Position: 80, 3, 16, 4, PosHigh, PosMed, PosLow, 0
 - b. Alt Set Position: 80, 3, 17, 4, PosHigh, PosMed, PosLow, 0

APPENDIX E – MAPS OF TIME ZONES

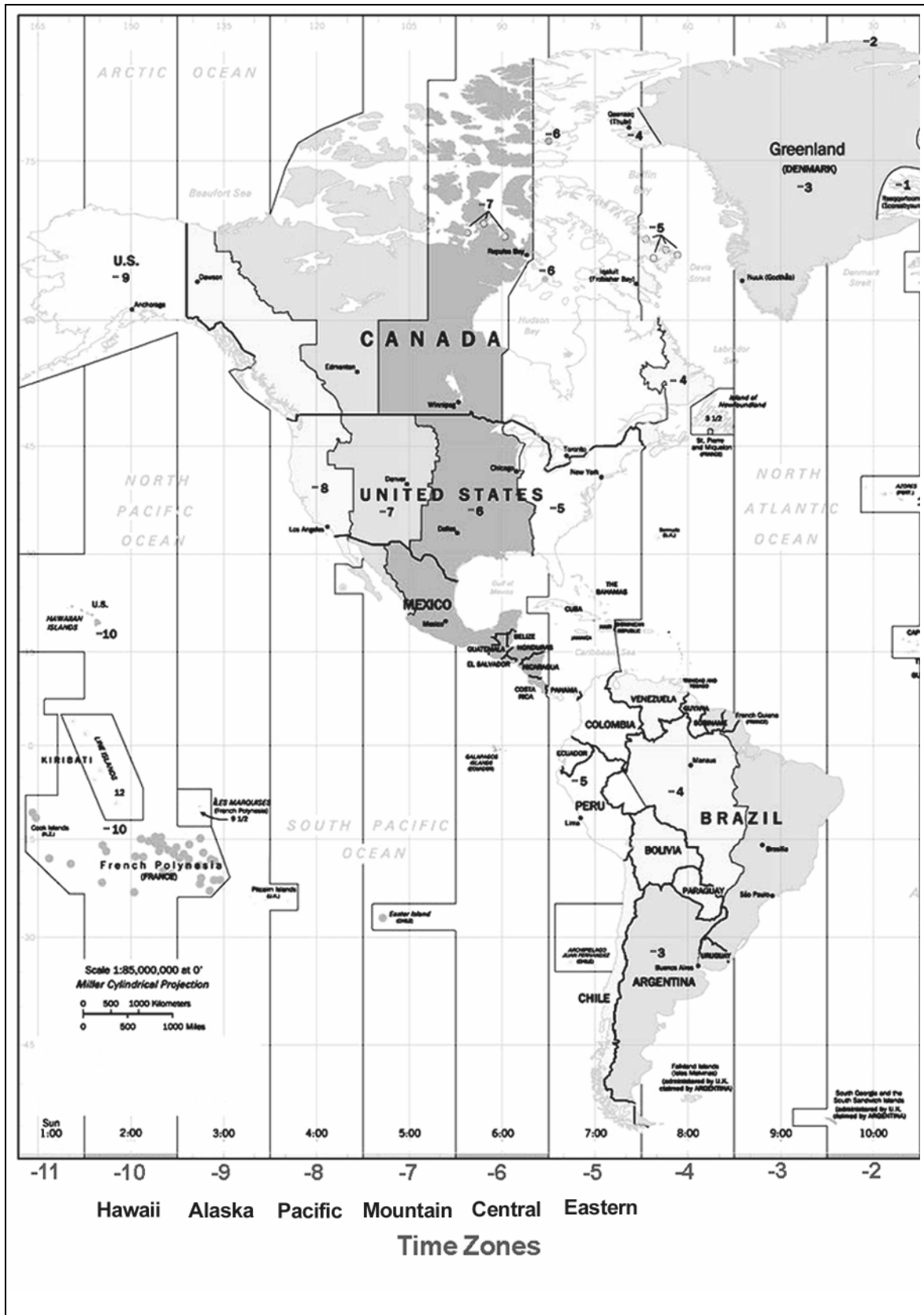

January - February Sky

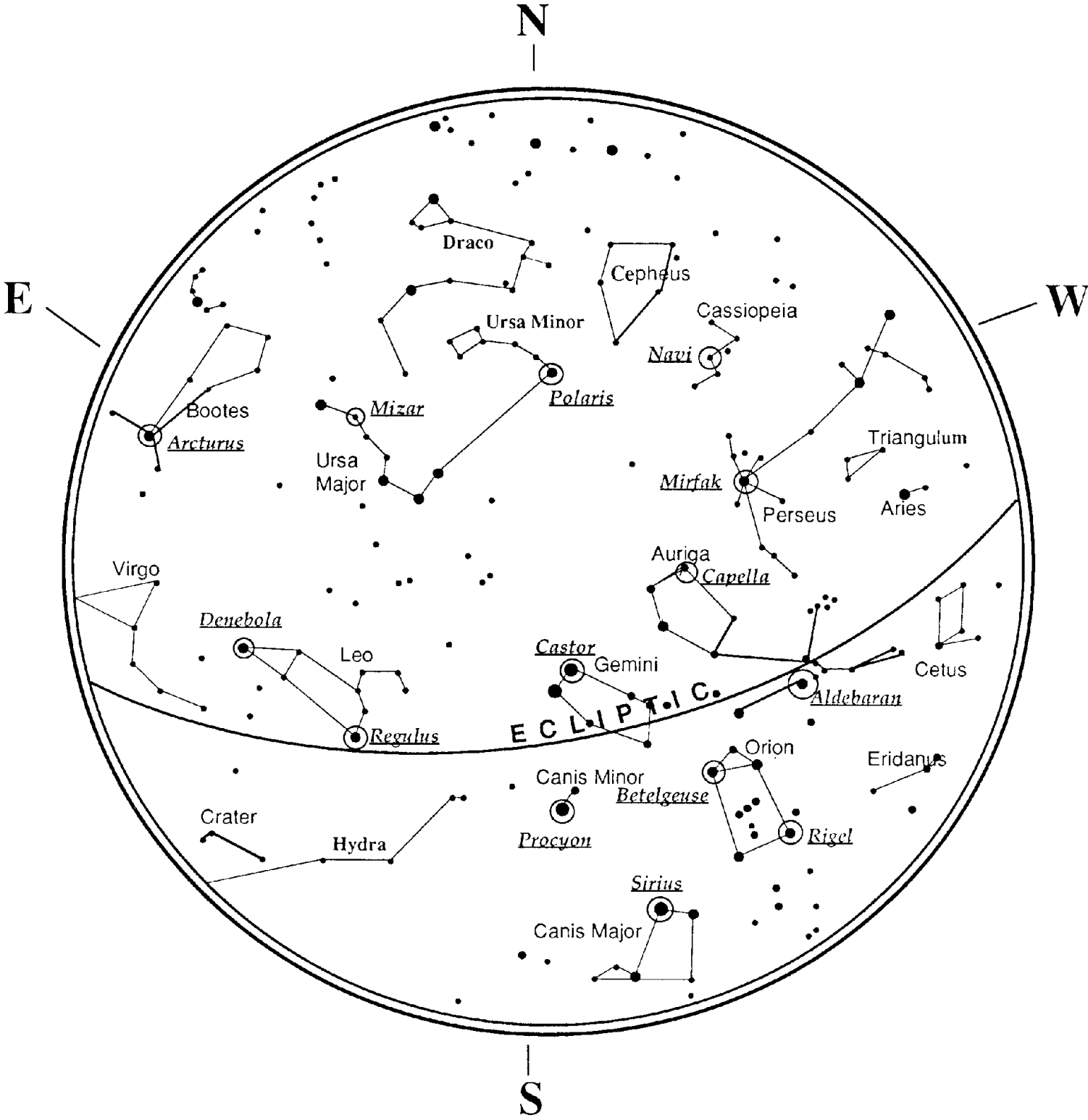

March - April Sky

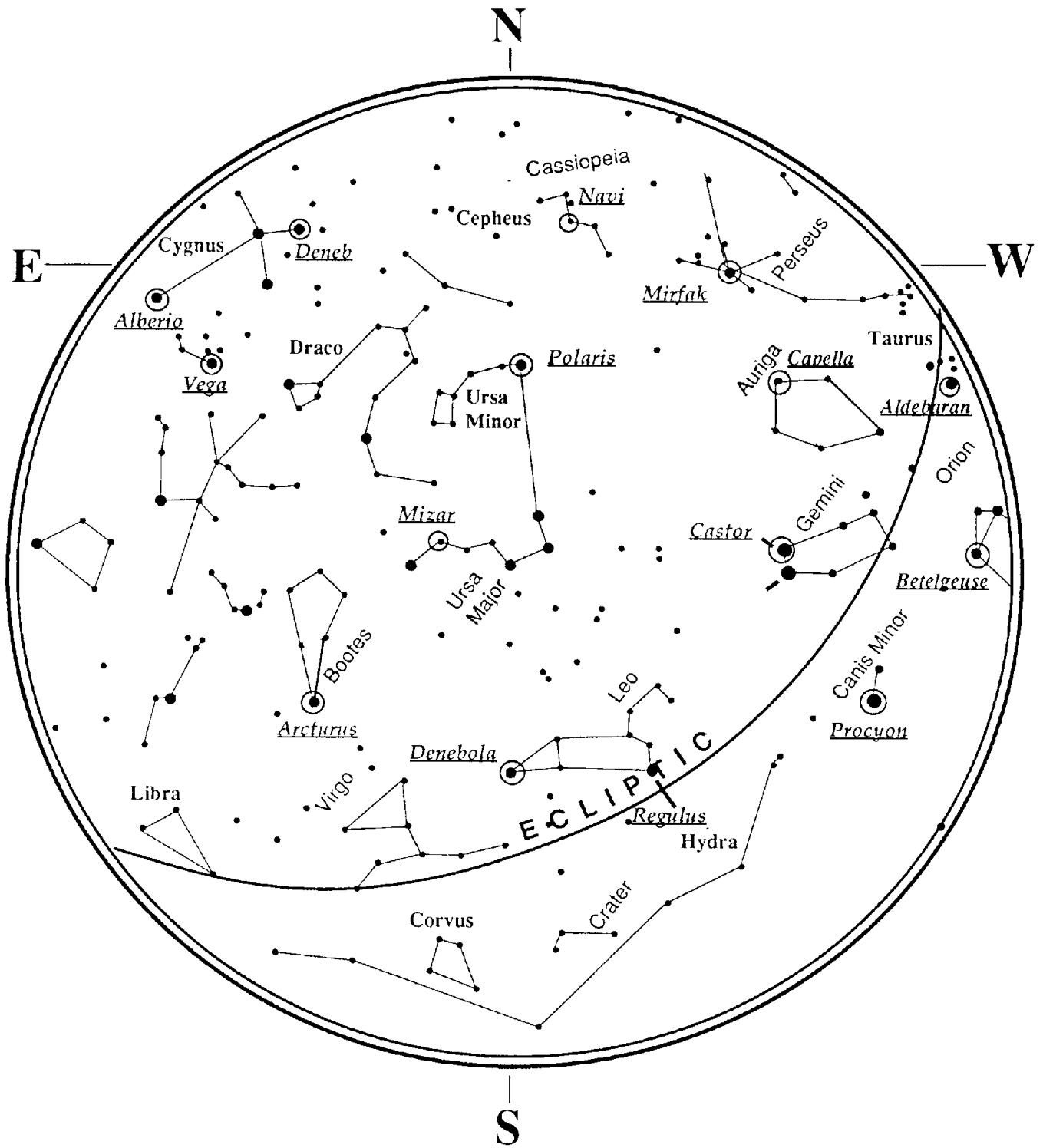

May - June Sky

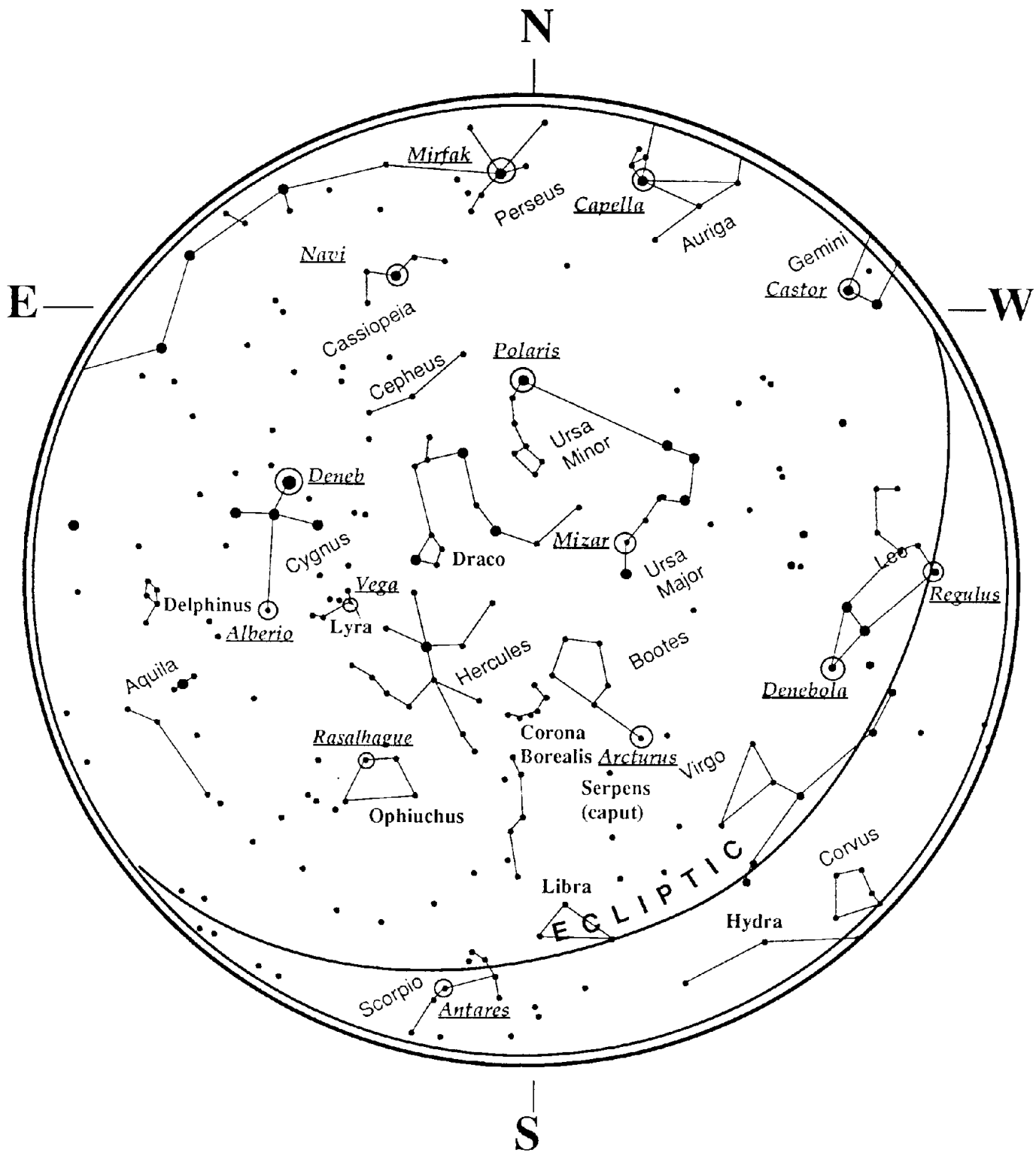

July - August Sky

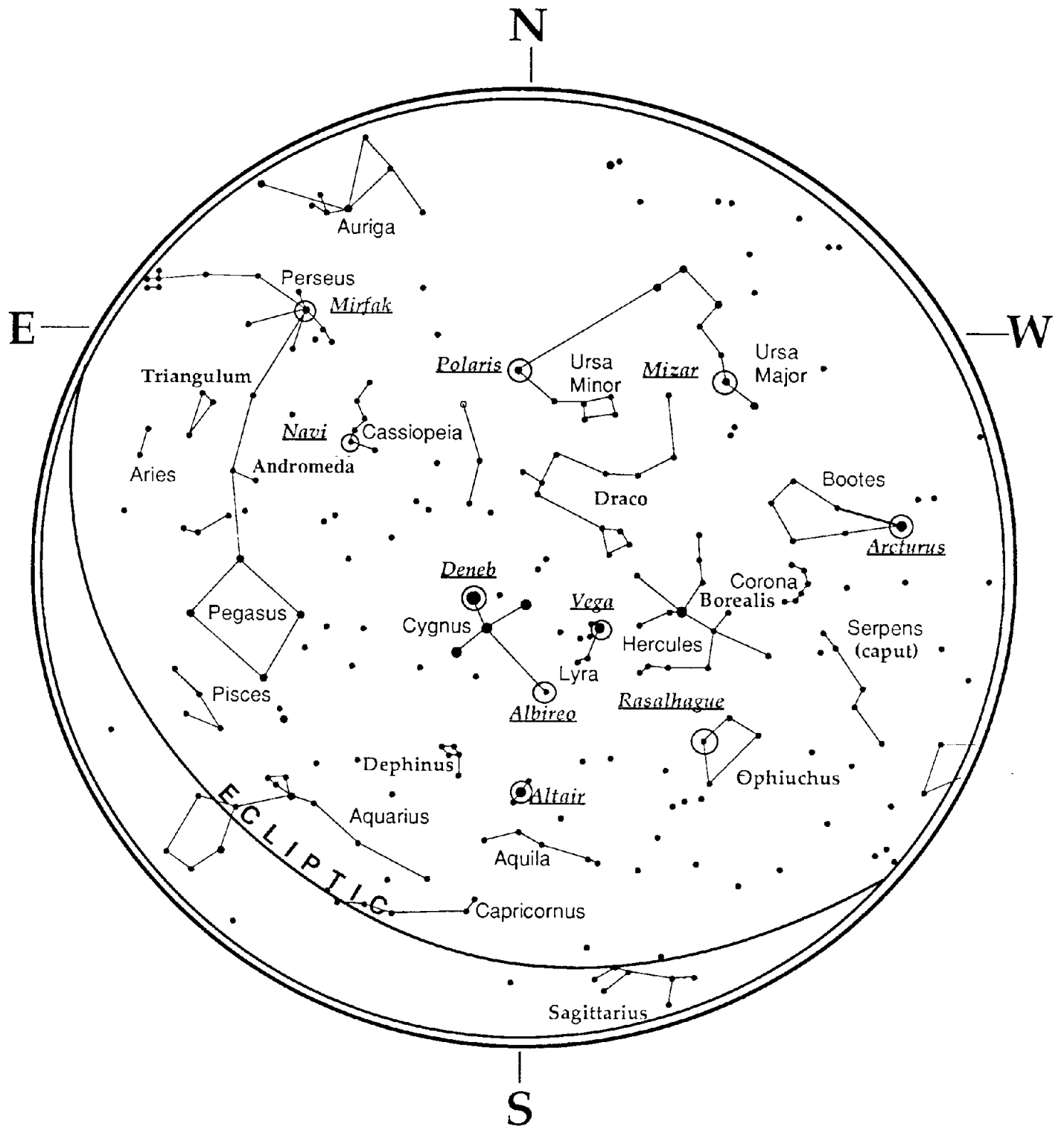

September - October Sky

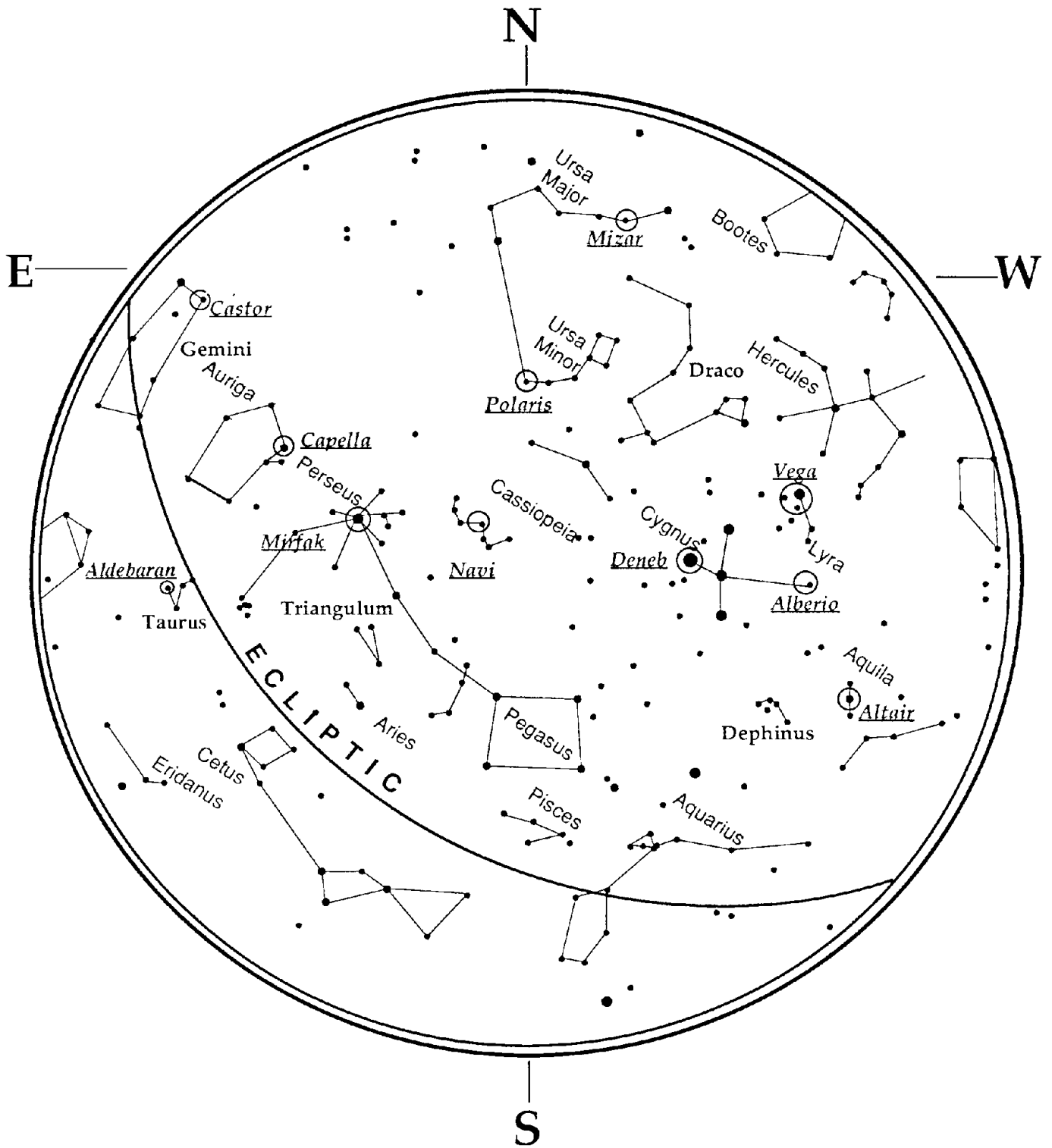

November - December Sky

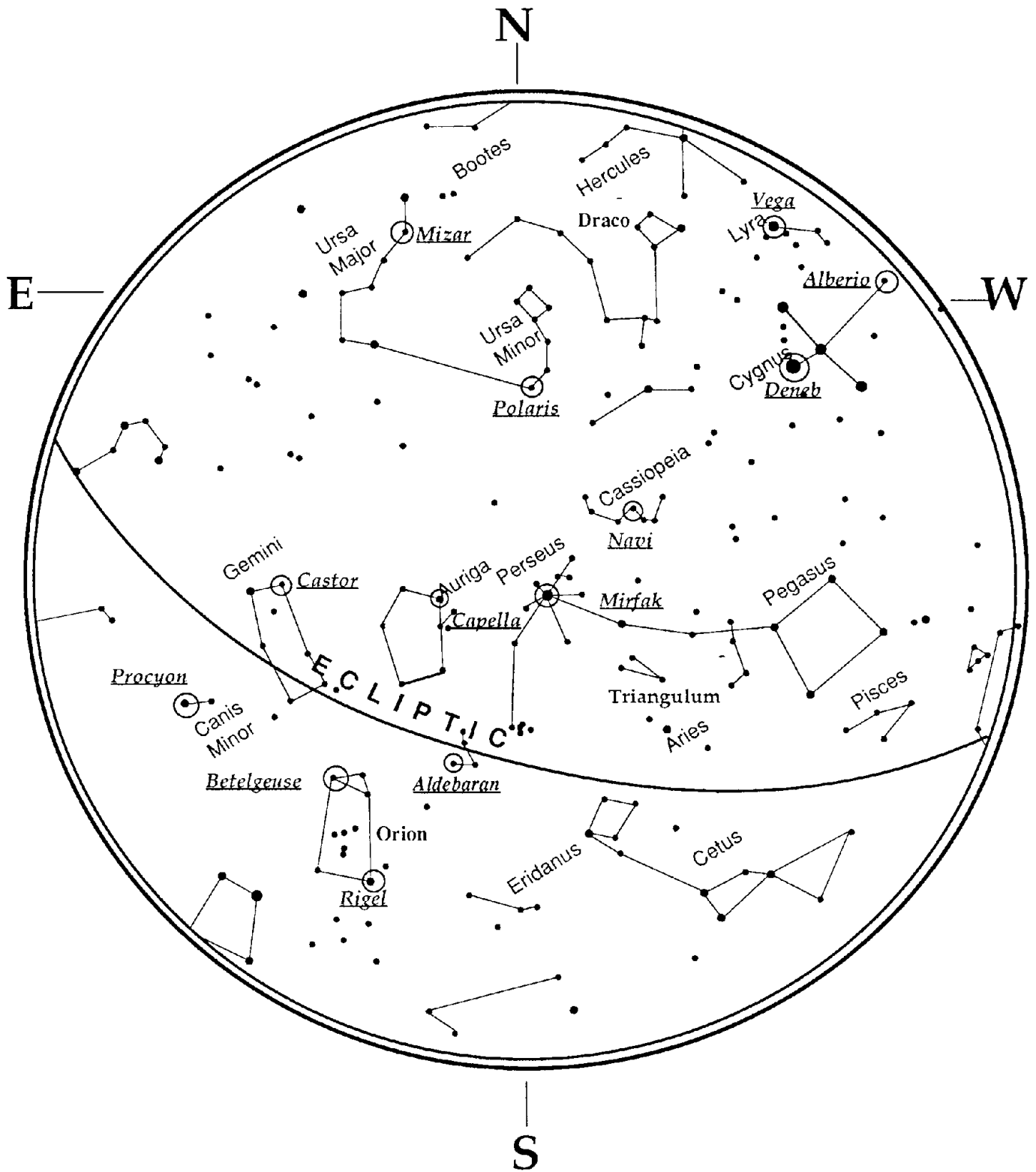

CELESTRON TWO YEAR WARRANTY

- A. Celestron warrants this telescope to be free from defects in materials and workmanship for two years. Celestron will repair or replace such product or part thereof which, upon inspection by Celestron, is found to be defective in materials or workmanship. As a condition to the obligation of Celestron to repair or replace such product, the product must be returned to Celestron together with proof-of-purchase satisfactory to Celestron.
- B. The Proper Return Authorization Number must be obtained from Celestron in advance of return. Call Celestron at (310) 328-9560 to receive the number to be displayed on the outside of your shipping container.

All returns must be accompanied by a written statement setting forth the name, address, and daytime telephone number of the owner, together with a brief description of any claimed defects. Parts or product for which replacement is made shall become the property of Celestron.

The customer shall be responsible for all costs of transportation and insurance, both to and from the factory of Celestron, and shall be required to prepay such costs.

Celestron shall use reasonable efforts to repair or replace any telescope covered by this warranty within thirty days of receipt. In the event repair or replacement shall require more than thirty days, Celestron shall notify the customer accordingly. Celestron reserves the right to replace any product which has been discontinued from its product line with a new product of comparable value and function.

This warranty shall be void and of no force of effect in the event a covered product has been modified in design or function, or subjected to abuse, misuse, mishandling or unauthorized repair. Further, product malfunction or deterioration due to normal wear is not covered by this warranty.

CELESTRON DISCLAIMS ANY WARRANTIES, EXPRESS OR IMPLIED, WHETHER OF MERCHANTABILITY OF FITNESS FOR A PARTICULAR USE, EXCEPT AS EXPRESSLY SET FORTH HEREIN.

THE SOLE OBLIGATION OF CELESTRON UNDER THIS LIMITED WARRANTY SHALL BE TO REPAIR OR REPLACE THE COVERED PRODUCT, IN ACCORDANCE WITH THE TERMS SET FORTH HEREIN. CELESTRON EXPRESSLY DISCLAIMS ANY LOST PROFITS, GENERAL, SPECIAL, INDIRECT OR CONSEQUENTIAL DAMAGES WHICH MAY RESULT FROM BREACH OF ANY WARRANTY, OR ARISING OUT OF THE USE OR INABILITY TO USE ANY CELESTRON PRODUCT. ANY WARRANTIES WHICH ARE IMPLIED AND WHICH CANNOT BE DISCLAIMED SHALL BE LIMITED IN DURATION TO A TERM OF TWO YEARS FROM THE DATE OF ORIGINAL RETAIL PURCHASE.

Some states do not allow the exclusion or limitation of incidental or consequential damages or limitation on how long an implied warranty lasts, so the above limitations and exclusions may not apply to you.

This warranty gives you specific legal rights, and you may also have other rights which vary from state to state.

Celestron reserves the right to modify or discontinue, without prior notice to you, any model or style telescope.

If warranty problems arise, or if you need assistance in using your telescope contact:

Celestron
Customer Service Department
2835 Columbia Street
Torrance, CA 90503 U.S.A.
Tel. (310) 328-9560
Fax. (310) 212-5835
Monday-Friday 8AM-4PM PST

This warranty supersedes all other product warranties.

NOTE: This warranty is valid to U.S.A. and Canadian customers who have purchased this product from an Authorized Celestron Dealer in the U.S.A. or Canada. Warranty outside the U.S.A. and Canada is valid only to customers who purchased from a Celestron Distributor or Authorized Celestron Dealer in the specific country and please contact them for any warranty service.



Celestron
2835 Columbia Street
Torrance, CA 90503 U.S.A.
Tel. (310) 328-9560
Fax. (310) 212-5835
Web site at <http://www.celestron.com>

Copyright 2003 Celestron
All rights reserved.

(Products or instructions may change
without notice or obligation.)

Item # 31061-INST
Printed in China
\$10.00
09-03