

# ZANUSSI



## CHEST FREEZER

### ZFC 177 C

**OPERATING AND INSTALLATION MANUAL**

GB

820 41 82 94

# IMPORTANT SAFETY INSTRUCTIONS

These warnings are provided in the interests of your safety. Ensure that you understand them all before installing or using this appliance. Your safety is of paramount importance. If you are unsure about any of the meanings or these warnings contact the Customer Care Department.

## Prior to Installation

Check the appliance for transport damage. Under no circumstances should a damaged appliance be installed. In the event of damage please contact your retailer.

## Installation

- This appliance is heavy. Care should be taken when moving it.
- It is dangerous to alter the specifications or attempt to modify this product in any way.
- Ensure that the appliance does not stand on the electrical supply cable.  
**Important:** If the supply cable is damaged, it must be replaced by authorised service or qualified personnel using a special cable of the same type.
- Any electrical work required to install this appliance should be carried out by a qualified electrician or competent person.
- Parts which heat up should not be exposed. Whenever possible, the back of the appliance should be close to a wall, but leaving the required distance for ventilation, as stated in the installation instructions.
- The appliance should be left for 2 hours after installation before it is turned on, in order to allow the refrigerant to settle.

## Refrigerant

- The refrigerant isobutane (R 600a) is contained within the refrigerant circuit of the appliance, a natural gas with a high level of environmental compatibility, which is nevertheless flammable.
- During transportation and installation of the appliance, be certain that none of the components of the refrigerant circuit become damaged.
- If the refrigerant circuit should become damaged:
  - avoid open flames and sources of ignition.
  - thoroughly ventilate the room in which the appliance is situated.

## Child Safety

- Do not allow children to tamper with the controls or play with the product.
- There is a risk of suffocation! Keep packaging material away from children!

## General Safety

- This appliance contains hydrocarbons in its cooling unit; maintenance and recharging must therefore only be carried out by authorised technicians.
- Take utmost care when handling your appliance so as not to cause any damages to the cooling unit with consequent possible fluid leakages.
- The appliance must not be located close to radiators or boilers.
- Avoid prolonged exposure of the appliance to direct sunlight.

- Do not use other electrical appliances (such as ice cream makers) inside of refrigerating appliances.

## During Use

- This appliance is designed for domestic use only, specifically for the storage of edible foodstuffs. It is not intended for commercial or industrial use.
- Containers with flammable gases or liquids can leak at low temperatures. Do not store any containers with flammable materials, such as spray cans, fire extinguisher refill cartridges etc. in the refrigerator.

## Maintenance and Cleaning

- Before cleaning, always switch off the appliance and disconnect from the electrical supply.
- When unplugging always pull the plug from the mains socket, do not pull on the cable.

## Servicing

- This product should be serviced by an authorised engineer and only genuine spare parts should be used.
- Under no circumstances should you attempt to repair the appliance yourself. Repairs carried out by inexperienced persons may cause injury or serious malfunctioning. Contact your local Service Force Centre.

## At the end of the Appliance Life

- When disposing of your appliance use an authorised disposal site.
- Check with your local Council or Environmental Health Officer to see if there are facilities in your area for recycling the appliance.
- Remove the plug and ensure that any locks or catches are removed, to prevent young children being trapped inside.
- **Make sure that the power plug is not squashed or damaged by the back of the fridge/freezer.**
  - A damaged power plug may overheat and cause a fire.
- **Do not place heavy articles or the fridge/freezer itself on the power cord.**
  - There is a risk of a short circuit and fire.
- **Do not remove the power cord by pulling on its lead, particularly when the fridge/freezer is being pulled out of its niche.**
  - Damage to the cord may cause a short-circuit, fire and/or electric shock.
  - If the power cord is damaged, it must be replaced by a certified service agent or qualified service personnel.
- **If the power plug socket is loose, do not insert the power plug.**
  - There is a risk of electric shock or fire.

# Contents

## Instructions for the User

<b>Important Safety Information</b>	2
<b>Description of the Appliance</b>	4
<b>Control Panel</b>	4
<b>Operation</b>	
Before use	5
Starting the Appliance	5
Alarm light	5
Temperature Control	5
Opening/Closing the Lid	5
The role of the pressure equalisation valve	6
Freezing Fresh Food	6
Frozen Food Storage	6
Thawing	6
Low Frost System.	6
Baskets	7
<b>Hints and Tips</b>	
Normal Operating Sounds	8
Food Storage	8
Energy Saving Advice	8
In the Event of a Power Failure	8
<b>Defrosting</b>	9
<b>Maintenance and Cleaning</b>	
Internal cleaning	10
External cleaning	10
When the appliance is not in use	10
Lock	10
<b>Something Not Working</b>	11
<b>Service and Spare Parts</b>	12
<b>Customer Care</b>	12
<b>Guarantee Conditions</b>	13

## Instructions for the Installer

<b>Technical Specifications</b>	16
<b>Installation</b>	
Positioning	16
<b>Electrical Connections</b>	17

### Guide to Use the Instructions



The symbol on the product or on its packaging indicates that this product may not be treated as household waste. Instead it shall be handed over to the applicable collection point for the recycling of electrical and electronic equipment. By ensuring this product is disposed of correctly, you will help prevent potential negative consequences for the environment and human health, which could otherwise be caused by inappropriate waste handling of this product. For more detailed information about recycling of this product, please contact your local city office, your household waste disposal service or the shop where you purchased the product.

The following symbols will be found in the text to guide you throughout the instructions:



Safety instructions



Step by step instructions for an operation



Hints and Tips

# Description of the Appliance

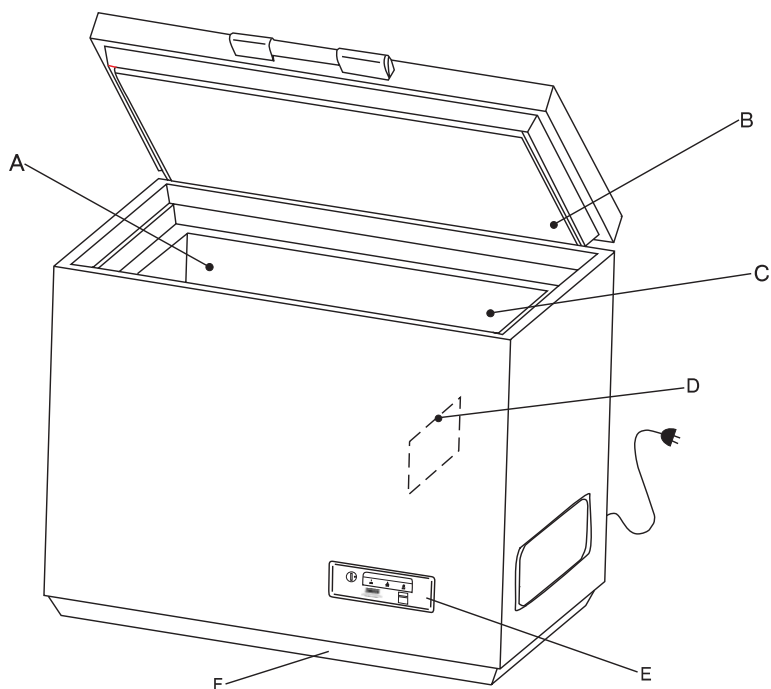

- A - Compartment for frozen food storage
- B - Freezer calendar (recommended storage times for frozen foods)
- C - Compartment for freezing fresh foods
- D - Dividing wall
- E - Control panel
- F - Defrost water drain

## Control Panel

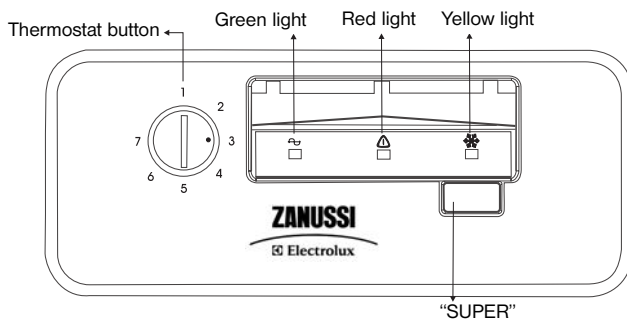

# Operation

## Before Use

Remove all packaging and securing tapes. Wash inside the appliance with lukewarm water and bicarbonate of soda (5ml to 0.5 litre of water). Do not use soap or detergent as the smell may linger. Dry thoroughly.

## Starting the Appliance

Insert the plug into the wall socket. The green pilot light will illuminate to show that the appliance is switched on.

The red alarm light will also illuminate until the freezer reaches the correct temperature.

## Alarm Light

The red alarm light will illuminate when the temperature in the freezer is higher than the thermostat setting. This alarm light will illuminate if:

- The appliance has just been started.
- Fresh food has been put in the freezer.
- The lid has been left open, opened frequently or open for too long.

The red light will go out when the freezer has returned to the correct temperature.

## Temperature Control

The temperature within the freezer is controlled by the thermostat situated on the lower front of the cabinet. To operate the freezer, proceed as follows:-

When you first start the freezer we suggest that you turn the thermostat to a medium setting ie 3-4. The correct setting can be found by measuring the temperature of the top middle package in the freezer. This should not have a temperature warmer than -18°C.

1 = Lowest setting, minimum cold

7 = Highest setting, maximum cold

Allow the freezer to run for several hours before placing food inside.

Do not fill the freezer to more than 5mm below the top edge.

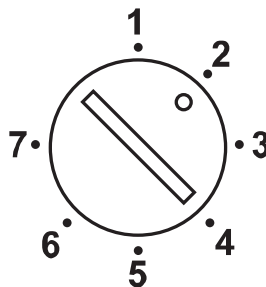

## Opening/Closing the Lid

The lid is fitted with a tightly closing sealing strip to prevent moisture entering the freezer, increasing the amount of frost formed.

When the lid is opened the air inside the freezer becomes slightly warmer and expands. When the lid is closed again the air is cooled immediately. This may lead to the creation of a vacuum which makes it hard to open the lid again immediately. Never use excessive force on the handle.

## Freezing Fresh Food

It is important that fresh food placed in the freezer is frozen quickly and that the food already in the freezer is heated as little as possible.

 If more than 3-4kg of food is to be frozen:

1. Press the SUPER button 6-24 hours before placing fresh food in the freezer. The freezer will now run continuously creating a sufficient reserve of the required temperature.
2. Place the food in the freezer and leave the SUPER button on for a further 24 hours.
3. Then turn the SUPER button off. The freezer will return to normal storage conditions.

 *If you forget to turn the SUPER button off, the freezer will not be damaged, but energy will be wasted.*

## Capacity

The freezing capacity of the freezer is stated in the rating plate (kg/24 hours). Do not exceed the amount stated - if you do, the freezing time will be extended. The rating plate is located inside the lid.

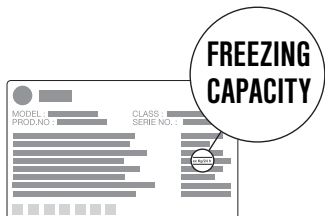

If you wish to freeze food several days in a row, please observe a maximum capacity of only 2/3 to 3/4 of that on the rating plate. The quality of the food is best preserved when it is frozen right through to the core as quickly as possible.

## Frozen Food Storage

When first starting the freezer or if the freezer has been out of use for some time, we advise you to run your appliance for at least 2 hours before storing frozen food.

Do not exceed the storage period indicated by the manufacturer.

Do not open the lid frequently or leave it open longer than is necessary.

 **Important**

*Do not put carbonated liquids in the freezer.*

*Ice lollies, if consumed immediately after removal from the freezer can cause a low temperature skin burn.*

*Do not remove items from the freezer if your hands are damp/wet, as this could cause skin abrasions or frost/freezer burns.*

*In the event of a power cut, do not open the lid. The food in the freezer will not be affected if the power cut is short and the freezer is full. Should the food begin to thaw it must be consumed quickly and must not be re-frozen.*

*(See Hints and Tips)*

## Thawing

Frozen food, prior to being used, can be thawed in the fridge or at room temperature, depending on the time available. Small food items may even be cooked from frozen, in this case cooking will take longer.

Any frozen food which is allowed to thaw accidentally should either be eaten as soon as possible, or thrown away. Alternatively, if the food is uncooked and has not been completely defrosted it can be cooked and then refrozen.

 **Defrosted cooked food must never be refrozen.**

## Baskets

The baskets are designed for the storage of food which has already been frozen. The handles can be placed in two positions, as shown.

The baskets can either be placed inside the freezer or hung on the edge of the casing.

The following spare parts can be ordered from your local Service Force Centre. Please note that 2 handles must be ordered for each basket.

Basket 291274248/7

Handle 291340008/6 (2 required).

The following illustrations show how many baskets can be placed in various freezer models.

The number above each illustration shows the width of the freezer in millimetres.

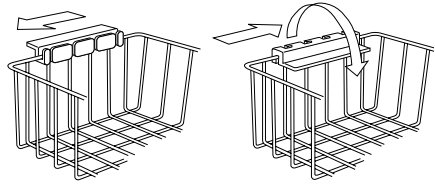

# Hints & Tips

## Normal Operating Sounds

- You may hear faint gurgling or bubbling sounds when the refrigerant is pumped through the coils or tubing.
- When the compressor is on, the refrigerant is being pumped round and you will hear a whirring sound or pulsating noise from the compressor.
- A thermostat controls the compressor and you will hear a faint 'click' when the thermostat cuts in and out.

## Food Storage

To obtain the best performance from your freezer:

- Do not store warm food or evaporating liquid.
- Avoid buying frozen food if you cannot store it straight away. The use of an insulated container is advisable. When you arrive home, place the frozen food in the freezer immediately.
- Do not push food together too much, try to allow air to circulate around each item.
- Do not store food uncovered.
- Ensure that food placed in the freezer is dated and labelled and used in date order to ensure that food is consumed at its best.
- Lean food keeps better and longer than fatty food, salt reduces the storage time.
- Wrap the food in polythene or aluminium freezing bags or foil so that they adhere to the food and provide an airtight seal.
- Packaging which is swollen or has traces of refrozen water droplets on the pack could indicate that the product has not been kept at a suitable temperature and that it may have lost its original quality. Partially thawed food must not be refrozen, it must be consumed within 24 hours. Never exceed the storage times indicated by the manufacturer.

## Energy Saving Advice

- Do not install the appliance close to sources of heat, such as a boiler or radiator.
- Locate the appliance in a cool well ventilated room and make sure that the air openings of the appliance are not obstructed.
- Avoid unnecessary frosting in the cabinet by packing all foodstuffs into airtight packages before placing them in the freezer.
- Food which is to be frozen (when cool) should be placed in the fridge before being transferred to the freezer.
- Try to avoid keeping the lid open for long periods or opening the lid too frequently as warm air will enter the cabinet and cause the compressor to switch on unnecessarily often.
- Ensure there are no obstructions preventing the lid from closing properly.

## In the Event of a Power Failure

If there is a power failure during the storage of frozen foods, keep the lid closed. If the temperature within your freezer should rise, do not refreeze the food without checking its condition. The following guidelines should assist you:

**Ice Cream:** Once thawed should be discarded.

**Fruits & Vegetables:** If soft should be cooked and used up.

**Breads & Cakes:** Can be refrozen without danger.

**Shellfish:** Should be refrigerated and used up quickly.

**Cooked Dishes:** i.e. casseroles should be refrigerated and used up.

**Large Pieces of Meat:** Can be refrozen providing there are still ice crystals remaining within them.

**Small Joints:** Should be cooked and can then be refrozen as cooked dishes.

**Chicken:** Should also be cooked and refrozen as a fresh dish.



## Defrosting

The freezer compartment will become progressively covered with frost. This should be removed with the special plastic scraper provided whenever the thickness of frost exceeds 1/4".

During this operation it is not necessary to switch off the power supply or to remove the foodstuffs.

However, when the ice becomes very thick on the inner liner, complete defrosting should be carried out and it is advisable to perform this operation when the appliance is empty.

 To carry out complete defrosting:

1. Disconnect the appliance from the electrical supply.
2. Remove any stored food, wrap in several layers of newspaper and store in a cool place.
3. Leave the lid open.
4. Remove the plug from the defrost water drain.
5. To accelerate the defrosting process place a bowl of hot (not boiling) water inside the freezer and close the lid.
6. The defrost water can be collected in a bowl, as shown.
7. When defrosting is completed, dry the interior thoroughly and replace the plug on the defrost water drain.
8. Reconnect the appliance to the electricity supply and leave to run for at least 2 hours on a medium setting.
9. Replace the previously removed food.

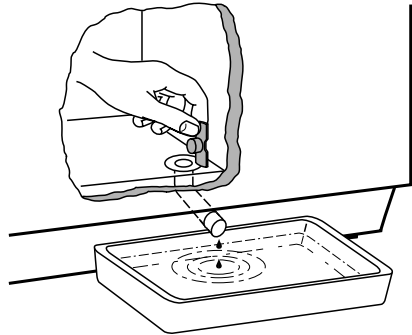

## Important

*A temperature rise of the frozen food packs during defrosting may shorten their safe storage life.*

*Never use sharp metal tools to scrape off frost from the evaporator as this could damage the appliance beyond repair.*

# Maintenance and Cleaning

 Before any maintenance or cleaning is carried out you must **DISCONNECT** the appliance from the electricity supply

## Internal Cleaning

Clean the inside and accessories with warm water and bicarbonate of soda (5ml to 0.5 litre of water).

Rinse and dry thoroughly.

 **NEVER use detergents, abrasive powders, highly perfumed cleaning products or wax polishes to clean the interior as these will damage the surface and leave a strong odour.**

## To Change the Light Bulb

(Not a standard accessory for all models)

1. Disconnect the appliance from the electrical supply.
2. Unscrew the bulb.
3. Replace with a new bulb (max. 15W)
4. Reconnect to the electrical supply.

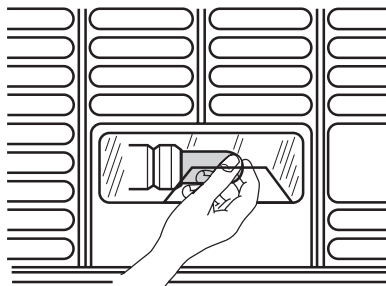

Spare bulbs are available from your local Service Force Centre.

## External Cleaning

Wash the outer cabinet with warm soapy water.

## When the Appliance is not in Use

When the appliance is not in use for long periods, disconnect from the electricity supply, empty all foods and clean the appliance, leaving the lid open to prevent unpleasant smells.

## LOCK

(Not a standard accessory for all models.) The freezer can only be locked when the upper lid is pushed to the right and the lower lid is pushed to the left. Insert the key in the lock and turn. The key can be removed. Remember to keep the key out of the reach of children.

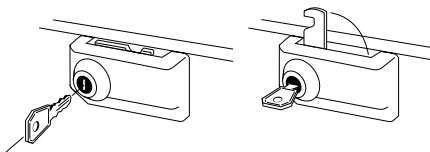

# Something not Working

**Before:** contacting your local Service Force Centre check the following point.

**IMPORTANT:** If you call out an engineer to a fault listed below, or to repair a fault caused by incorrect use or installation, a charge will be made even if the appliance is under guarantee.

Symptom	Check if....	Solution
No power to the appliance .	Plug not connected properly. Faulty fuse in the plug. There is a power failure.	Connect plug to the power supply. Replace the fuse if necessary. Leave the lid closed and wait for the power supply to be restored.
The temperature in the freezer is too warm.(red light on)	The thermostat control knob is set correctly relevant to the ambient conditions. Check that the ambient conditions. Check that the ambient temperature is within the appliance's operating limits of 10°C - 32°C. Fresh food has recently been placed in the freezer.	Turn the thermostat control knob to the appropriate setting (colder). Relocate the appliance.
The lid will not open.	The lid has recently been opened.	If it has wait a few minutes for the pressure inside the freezer to the equalise and then open the lid. Do not put excessive force on the handle.
Excessive frost and ice has built up.	The thermostat control knob is set correctly relevant to the ambient conditions. The lid closes correctly.  There is a large amount of moisture from the packaging of stored food.	Turn the thermostat control knob to the appropriate setting (warmer). Rearrange the stored food so that the lid can be closed correctly. Ensure that all food placed in the freezer is wrapped in airtight dry packaging.
The pressure equalisation valve does not close appropriately.	Some pollution has got into the valve.	The valve must be blown through from the airing outlet in the rear wall.

If after all above checks there is still a fault, call your local Service Force Centre.

**In-guarantee customers should ensure that the above checks have been made, as the engineer will make a charge if the fault is not a mechanical or electrical breakdown.**

Please note that proof of purchase is required for any in-guarantee service calls.

# Service and Spare Parts

In the event of your appliance requiring service, or if you wish to purchase spare parts, please contact your local Service Force Centre by telephoning:-

**0870 5 929929**

Your telephone call will be automatically routed to the Service Force Centre covering your post code area. For the address of your local Service Force Centre and further information about Service Force please visit the website at [www.serviceforce.co.uk](http://www.serviceforce.co.uk).

Before calling out an engineer, please ensure you have read the details under the heading "Something Not Working."

When you contact the Service Force Centre you will need to give the following details:

1. Your name, address and post code
2. Your telephone number
3. Clear and concise details of the fault
4. The model and serial number of the appliance (found on the rating plate)
5. The purchase date

## Customer Care Department

For general enquiries concerning your Zanussi appliance or for further information on Zanussi products, please contact our Customer Care Department by letter or telephone at the address below or visit our website at [www.zanussi.co.uk](http://www.zanussi.co.uk)

Customer Care Department  
Zanussi  
55-77 High Street  
Slough  
Berkshire  
SL1 1DZ  
08705 727727 (\*)

\* calls to this number may be recorded for training purposes.

# Guarantee Conditions

We, Zanussi undertake that if within 12 months of the date of the purchase this Zanussi appliance or any part thereof is proved to be defective by reason only of faulty workmanship or materials, the company will, at our option repair or replace the same FREE OF CHARGE for labour, materials or carriage on condition that:

- The appliance has been correctly installed and used only on the electrical supply stated on the rating plate.
- The appliance has been used for normal domestic purposes only, and in accordance with the manufacturer's instructions.
- The appliance has not been serviced, maintained, repaired, taken apart or tampered with by any person not authorised by us.
- All service work under this guarantee must be undertaken by a Zanussi Service Force Centre.
- Any appliance or defective part replaced shall become the Company's property.
- This guarantee is in addition to your statutory and legal rights.

Home visits are made between **8.30am** and **5.30pm Monday to Friday**. Visits may be available outside these hours in which case a premium will be charged.

## EXCLUSIONS

### This Guarantee does not cover:

Damage or calls resulting from transportation, improper use or neglect, the replacement of any light bulbs or removable parts of glass or plastic.

- Costs incurred for calls to put right an appliance improperly installed or calls to appliances outside the United Kingdom.
- Appliances found to be in use within a commercial environment, plus those which are the subject of rental agreements.
- Products of Zanussi manufacture which are not marketed by Zanussi.

## ZANUSSI EUROPEAN GUARANTEE

If you should move to another country within Europe then your guarantee moves with you to your new home subject to the following qualifications:

- The guarantee starts from the date you first purchased your product.
- The guarantee is for the same period and to the same extent for labour and parts as exists in the new country of use for this brand or range of products.
- This guarantee relates to you and cannot be transferred to another user.
- Your new home is within the European Community (EC) or European Free Trade Area
- The product is installed and used in accordance with our instructions and is only used domestically, i.e. a normal household.
- The product is installed taking into account regulations in your new country.

Before you move please contact your nearest Customer Care Centre, listed below, to give them details of your new home. They will then ensure that the local Service Organisation is aware of your move and able to look after you and your appliances.

France	Senlis	+33 (0)3 44 62 29 99
Germany	Nuremberg	+49 (0)911 323 2600
Italy	Pordenone	+39 (0)1678 47053
Sweden	Stockholm	+46 (0)8 738 79 50
UK	Slough	+44 (0)1753 219897

# Technical Specifications

Model		ZFC 177 C				
Volume (gross)	litres	500				
Volume (net)	litres	495				
Height with rollers	cm	87,6/88,3				
Width	cm	160				
Depth	cm	66,5				
Weight	kg	66				
Energy consumpt./24h	kWh	1,609				
Freezing capacity	kg/24h	20				
Hold-over time	hours	32				
Rated power	W	130				

☞ This appliance complies with the following EC Directives:

- 73/23/EEC of 19. 02. 1973 - Low-Voltage Directive

- 89/336/EEC of 03. 05. 1989 (including Amendment Directive 92/31/EEC - EMC Directive.

Some of the models are not available in all countries.

Testing has been carried out in accordance with ISO 5155 regarding the determination of freezer capacity, energy consumption and hold-over-time.

Information for test institute: A plan of the positioning of test packages may be obtained directly from the manufacturer.

## Installation

### Positioning

- Place the freezer horizontally on a firm surface, resting on all four wheels. Use a wooden block or similar object to compensate for any bumps/holes in the floor's surface.
- The room should be dry and adequately ventilated.
- Temperatures of the external environment have an impact on the energy consumption of the freezer. Therefore:
  - do not place the freezer in a position exposed to sunshine or beside a radiator oven, or any other source of heat.
  - position it where the temperature of the environment corresponds to the climatic classification for which the freezer was designed.

#### Climatic classification Ambient temperature limits

	From to	
SN	+10 to +32	C
N	+16 to +32	C
ST	+18 to +38	C
T	+18 to +43	C

- If the freezer has been handled standing on end, it should be allowed to stand in the normal position for about 12 hours before switching it on.
- Ensure that the appliance is installed where it is easily accessible for the engineer in the event of a breakdown.

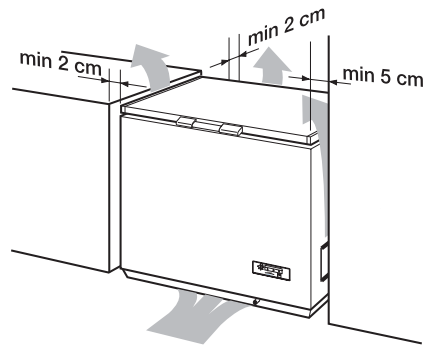

# Electrical Connection



Any electrical work required to install this appliance should be carried out by a qualified electrician or competent person.

This appliance must be earthed.

**The manufacturer declines any liability should these safety measures not be observed.**

## Electrical Requirements

Before switching on, make sure the electricity supply voltage is the same as that indicated on the appliance rating plate.

The appliance is supplied with a 13amp plug fitted. In the event of having to change the fuse in the plug supplied, a 13amp ASTA approved (BS1362) fuse must be used. Should the plug need to be replaced for any reason. The wires in the mains lead are coloured in accordance with the following code:

Green and Yellow: Earth

Blue: Neutral

Brown: Live

The wire coloured green and yellow must be connected to the terminal marked with the letter "E" or by the earth symbol  or coloured green and yellow.

The wire coloured blue must be connected to the terminal "N" or coloured black.

The wire coloured brown must be connected to the terminal marked "L" or coloured red.

Upon completion there must be no cut, or stray strands of wire present and the cord clamp must be secure over the outer sheath.

