

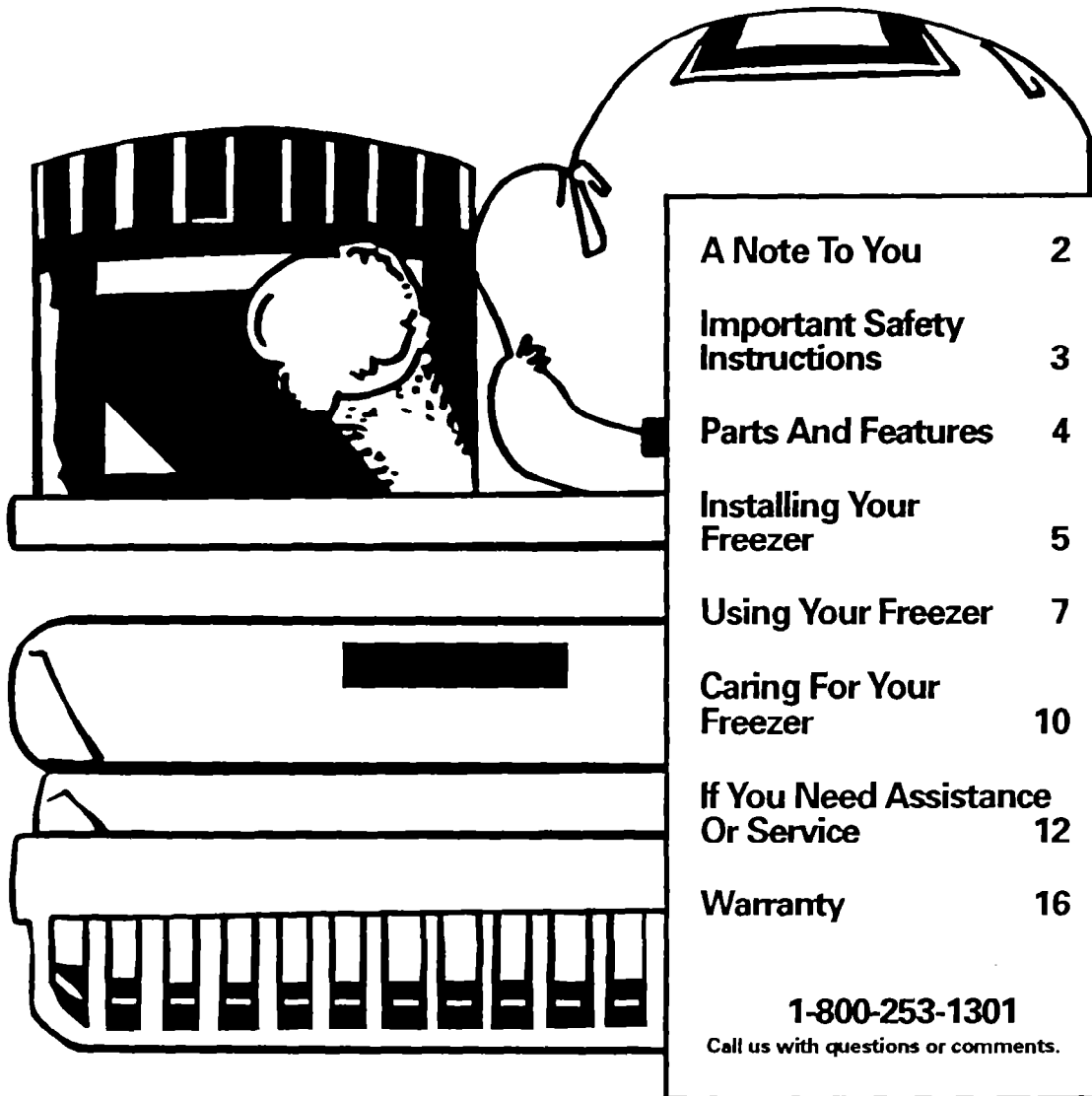

Use And Care

GUIDE



2-93

UPRIGHT FREEZERS

MODELS EV120FX EV150FX
EV170NX EV200FX

A NOTE TO YOU

A Note To You

Thank you for buying a Whirlpool appliance.

You have purchased a quality, *world-class* home appliance. Years of engineering experience have gone into its manufacturing. To ensure that you will enjoy many years of trouble-free operation, we have developed this Use and Care Guide. It is full of valuable information on how to operate and maintain your appliance properly and safely. Please read it carefully. Also, please complete and mail the Ownership Registration Card provided with your appliance. This will help us notify you about any new information on your appliance.

Your safety is important to us.

This guide contains safety symbols and statements. Please pay special attention to these symbols and follow any instructions given. Here is a brief explanation of the use of each symbol.

⚠ WARNING

This symbol will help alert you to such dangers as personal injury, burns, fire and electrical shock.

⚠ CAUTION

This symbol will help you avoid actions which could cause product damage (scratches, dents, etc.) and damage to your personal property.

Our Consumer Assistance Center number, 1-800-253-1301, is toll-free, 24 hours a day.

If you ever have a question concerning your appliance's operation, or if you need service, first see "If You Need Assistance Or Service" on page 21. If you need further help, feel free to call our Consumer Assistance Center. When calling, you will need to know your appliance's complete model number and serial number. You can find this information on the model and serial number plate (see diagram on page 6). For your convenience, we have included a handy place below for you to record these numbers, the purchase date from the sales slip and your dealer's name and telephone number. Keep this book and the sales slip together in a safe place for future reference.

Model Number _____

Dealer Name _____

Serial Number _____

Dealer Phone _____

Purchase Date _____

The Whirlpool Freezer Guide is also available.

The Whirlpool Freezer Guide is a companion book to this Freezer Use and Care Guide and is available free of charge. It contains information on freezing different kinds of foods, packaging and food storage times. The Freezer Guide also has helpful hints for saving energy and solving common freezer problems.

To order the Freezer Guide, write to:

Whirlpool Corporation
Attention: Customer Service Dept.
1900 Whirlpool Drive
LaPorte, IN 46305

and request the Whirlpool Freezer Guide, Part No. 1114865.

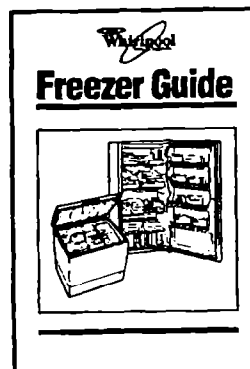

IMPORTANT SAFETY INSTRUCTIONS

Important Safety Instructions

⚠ WARNING

To reduce the risk of fire, electrical shock, or injury when using your freezer, follow these basic precautions:

- Read all operating instructions before using your freezer.
- Child entrapment and suffocations are not problems of the past. Junked or abandoned freezers are still dangerous, even if they will “just sit in the garage for a few days.”

If you are getting rid of your old freezer, do it safely. Please read the enclosed safety booklet from the Association of Home Appliance Manufacturers. Help prevent accidents.

- Never allow children to operate, play with, or crawl inside the freezer.
- Never clean freezer parts with flammable fluids. The fumes can create a fire hazard or explosion.

• FOR YOUR SAFETY •

DO NOT STORE OR USE GASOLINE OR OTHER FLAMMABLE VAPORS AND LIQUIDS IN THE VICINITY OF THIS OR ANY OTHER APPLIANCE. THE FUMES CAN CREATE A FIRE HAZARD OR EXPLOSION.

—SAVE THESE INSTRUCTIONS—

Help us help you

Please:

- Install and level the freezer on a floor that will hold the weight, and in an area suitable for its size and use.
- Connect the freezer only to the proper kind of outlet, with the correct electrical supply and grounding. (See “Locating the proper electrical supply” on page 5.)
- Use the freezer only to do what home freezers are designed to do.
- Do not install the freezer near an oven, radiator or other heat source.
- Properly maintain the freezer.
- Keep the freezer out of the weather.
- Use the freezer only in an area where the temperature will not exceed 110°F (43.3°C) or drop below 55°F (13°C).
- Make sure the freezer is not used by anyone unable to operate it properly.
- Do not load the freezer with food before it has time to get properly cold.

Also, please remove the Consumer Buy Guide Label, materials, tape and inside labels (except the model and serial number label) before using the freezer.

To remove any remaining glue:

- Rub briskly with thumb to make a ball, then remove.
OR
- Soak area with liquid hand dishwashing detergent before removing glue as described above.

Do not use sharp instruments, rubbing alcohol, flammable fluids or abrasive cleaners. These can damage the material. See “Important Safety Instructions” above.

NOTE: Do not remove the Tech Sheet located on the back of the freezer.

PARTS AND FEATURES

Parts And Features

This section contains captioned illustrations of your appliance. Use them to become familiar with where all parts and features are located and what they look like.

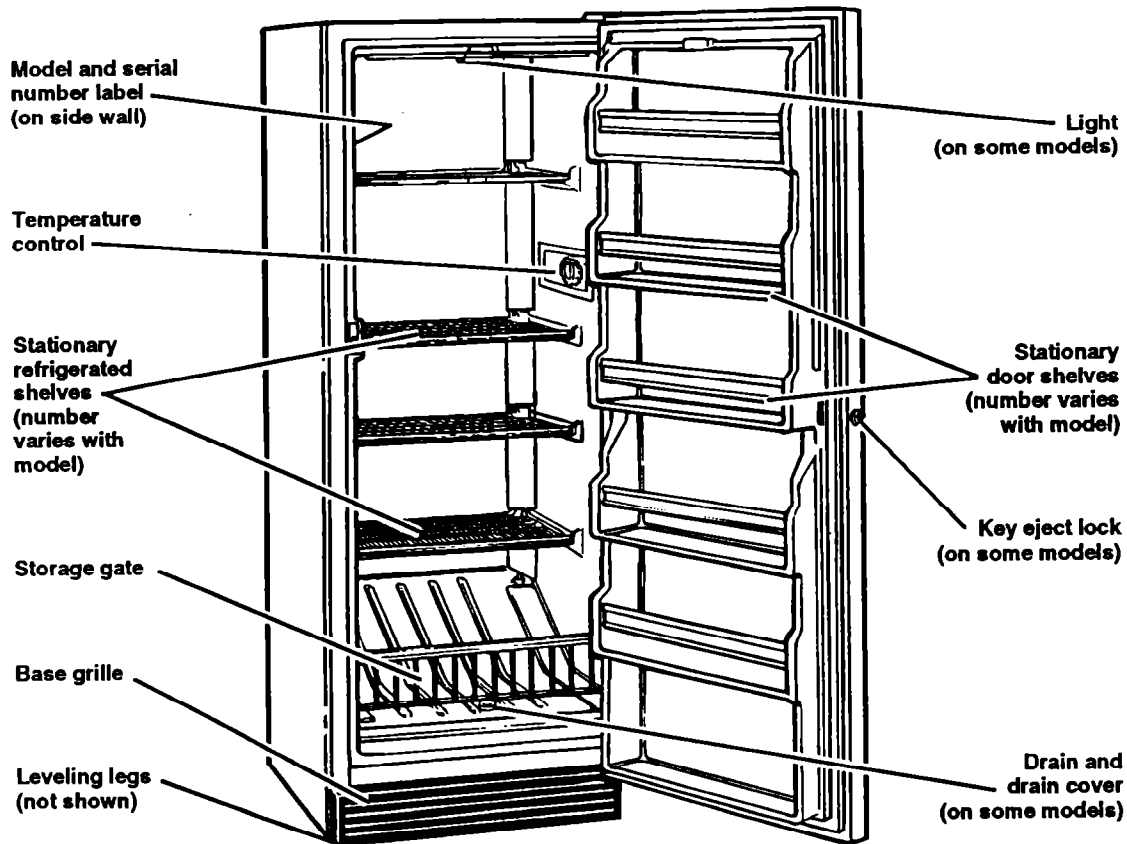

Installing Your Freezer

In This Section		Page
Installing the handle	5	Choosing the proper location
Cleaning your freezer	5	Completing the installation
Locating the proper electrical supply	5	6

Proper installation of any appliance is very important. This section will tell you everything you need to know to install your freezer properly.

Installing the handle

1. Remove screws from front of freezer door and discard.
2. Locate handle assembly kit among packing materials.
3. Attach top of handle to top hole in door with shorter of 2 screws provided.
4. Attach bottom of handle to lower hole in door with longer of 2 screws.
5. Snap trim piece into place.

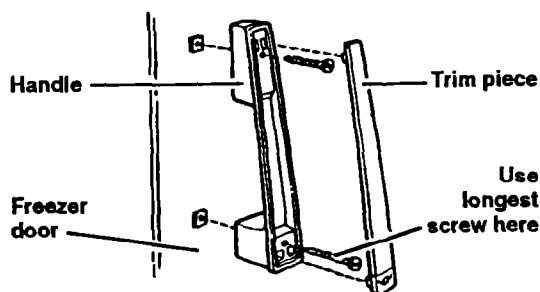

Cleaning your freezer

- Clean your freezer thoroughly before using it.
1. Use a sponge, cloth or paper towel and mild detergent in warm water to clean outside and inside of freezer, door liner and gasket.
 2. Rinse and dry thoroughly.

Locating the proper electrical supply

Recommended Grounding Method
 A 115 Volt, 60 Hz., AC only 15 or 20 ampere fused and properly grounded electrical supply is required. It is recommended that a separate circuit serving only this appliance be provided. Use a receptacle which cannot be turned off with a switch or pull chain. Do not use an extension cord.

Attach retaining clip, from literature package inside the freezer, over power cord plug. See Electrical Requirements and Grounding Instructions Sheet in literature package for complete details.

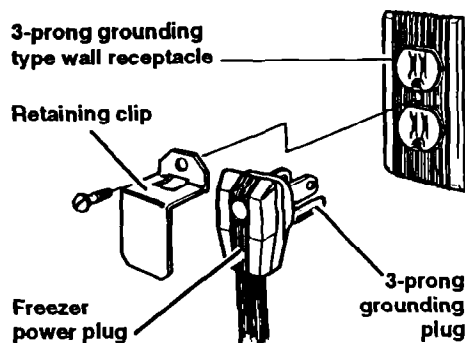

INSTALLING YOUR FREEZER

Choosing the proper location

Read the following items before choosing the location for the freezer. See "Completing the installation" below before sliding freezer into place.

1. Pick a safe place, indoors, away from flammables such as gasoline.
2. Check the strength of the floor. It should hold the weight of a fully loaded freezer.
3. Allow at least 3 inches (7.5 cm) of air space at top of freezer.
4. Allow at least 3 inches (7.5 cm) on each side of the freezer for ease of installation.
5. If the freezer is to be against a wall, you might want to leave extra space on the hinge side so the door can be opened wider.

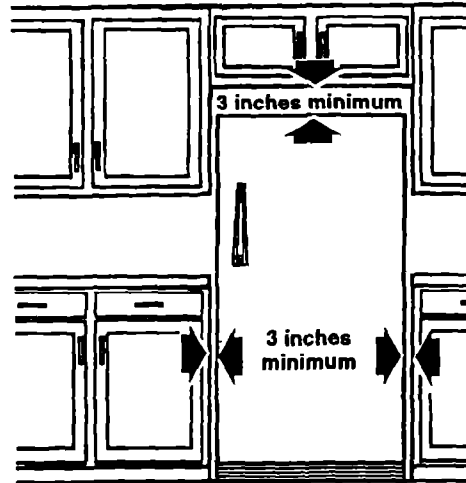

Completing the installation

Level freezer so the door will stay open at any position.

1. Locate, remove and discard the 4 bolts that held the freezer in the shipping crate.
2. Locate the 2 front leveling legs taped among the packing materials.
3. Screw these legs into the front holes on the bottom of the freezer. The back of the freezer rests on 2 fixed supports.
4. Adjust the 2 front legs so freezer does not rock.
5. Connect freezer to proper electrical supply and attach retaining clip. (Refer to "Locating the proper electrical supply" on page 5.)
6. Slide freezer into place.
7. Place a level on top of the freezer—first side to side then front to back. Turn leg clockwise to raise a corner. Turn leg counterclockwise to lower a corner.
8. Repeat step 7 until the freezer is level.
9. After freezer is fully loaded, recheck with level.

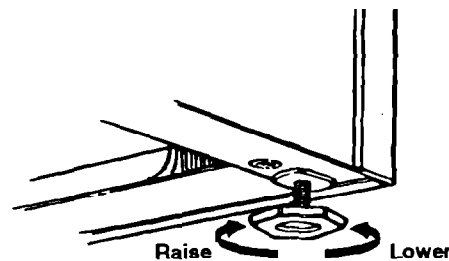

Using Your Freezer

In This Section		Page	Page
Setting the temperature control	7	Removing the base grille	8
Adjusting the temperature control	7	Using the drain system	9
Using the refrigerated shelves	8	Changing the light bulb	9
Using the lower storage gate	8	Using the key eject lock	9

In order to obtain the best possible results from your freezer, you must operate it properly. This section will tell you how to do just that.

Setting the temperature control

Turn the control to 4. This setting is designed to maintain the temperature at or near 0°F (-17.8°C) under normal operating conditions.

Allow the freezer to cool 6 to 8 hours before filling with frozen food. Let the freezer cool overnight before adding large amounts of unfrozen food. Never add more than 2-3 pounds of unfrozen food per cubic foot of freezer space.

NOTE: When the freezer is first started, the compressor will run constantly until the cabinet is cooled. It may take up to 6 to 8 hours or longer, depending on room temperature and the number of times the freezer door is opened.

After the cabinet is cooled, the compressor will turn on and off as needed to keep the freezer at the proper temperature.

The outside of your freezer may feel warm. This is normal. The freezer's design and main function is to remove heat from packages and air space inside the freezer. This heat is transferred to the room air, so the outside of the freezer may feel warm.

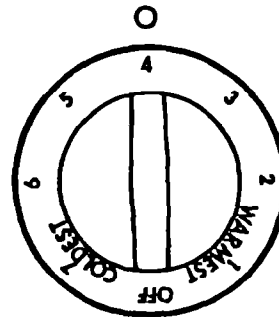

Adjusting the temperature control

- Turn control to a higher number for colder temperatures.
- Turn control to a lower number for less cold temperatures.

USING YOUR FREEZER

Using the refrigerated shelves (On some models)

Your freezer is equipped with refrigerated interior shelves. Packages in direct contact with the shelves will have the best refrigeration. Fresh, unfrozen food packages should be stored directly on the shelves and not on top of already frozen food packages.

When placing the food packages in your freezer, please remember:

- The cabinet shelves have the best freezing capability. The door shelves and the bottom of the cabinet have a slightly higher temperature. Therefore, packages sensitive to temperature (meat, poultry, etc.) should not be placed on the door shelves or the freezer bottom.
- Give the cold air a chance to completely surround the packages.

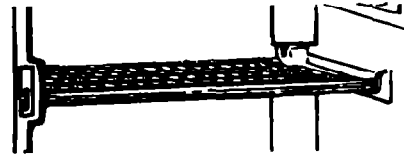

Using the lower storage gate

To lower gate:

1. Lift top of gate up slightly to clear supports.
2. Pull gate forward.

To raise gate:

1. Return gate to upright position.
2. Lift top of gate slightly to clear supports.
3. Lower gate into supports.

Pull top up,
then forward.

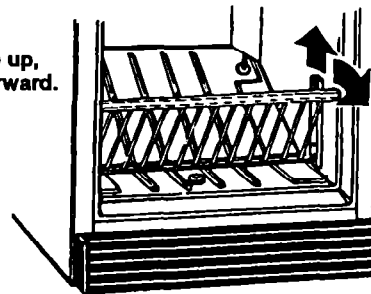

Removing the base grille

For Manual-defrost models: The base grille will need to be removed when defrosting the freezer.

To remove the grille:

1. Open the door.
2. Pull on both sides of the grille.

To replace the grille:

1. Line up grille support tabs with openings in freezer cabinet.
2. Push firmly to snap grille into place.
3. Close the door.

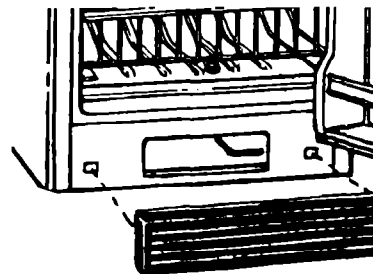

Using the drain system (On some models)

The freezer's drain system consists of:

- drain cap and sleeve (at the liner and cabinet bottom); and
- drain hose.

The drain hose carries defrost water out of the freezer, and through the area behind the base grille, into a customer provided pan for disposal.

NOTE: The drain cap must be removed before defrosting the freezer, and replaced securely afterward.

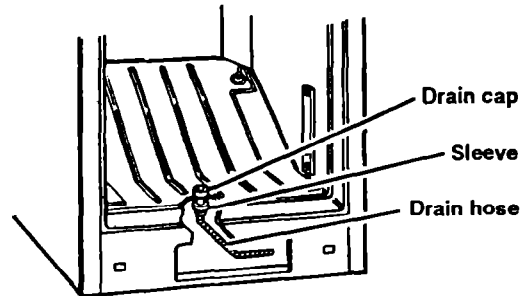

Changing the light bulb (On some models)

⚠ WARNING

Electrical Shock Hazard

Before removing the light bulb, either turn Temperature Control to OFF and unplug the freezer, or disconnect the electricity leading to the freezer at the main power supply.

Shock and injury can occur if electricity remains connected.

To replace interior light:

1. Turn Temperature Control to OFF and disconnect freezer from power supply.
NOTE: Turning Temperature Control to OFF does not disconnect power to the freezer.
2. Remove the light shield by squeezing sides slightly and pulling out.
3. Replace bulb with 15-watt appliance bulb.
4. Replace light shield. Insert back tabs into slots and squeeze shield slightly to insert front tabs into slots.
5. Reconnect freezer to power supply and refer to "Setting the temperature control" on page 7.

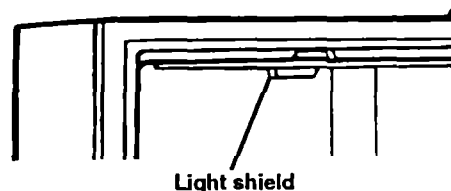

Using the key eject lock (On some models)

If your freezer is equipped with a lock, it can help reduce the hazard of child entrapment.

To lock or unlock the freezer, you must hold the key in the lock while turning. The lock is spring loaded, so the key cannot be left in the lock.

If the key is lost, contact your Whirlpool dealer for a replacement. Always give the complete model and serial number of your freezer when requesting a replacement key.

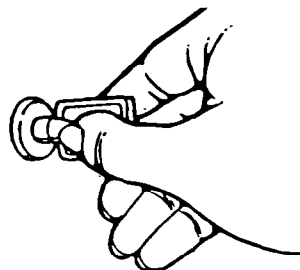

Caring For Your Freezer

In This Section		Page	Page
Manual-defrost models	10	What to do during power outages	11
Frost-free models	11	Moving care	11

Your freezer is designed to give you years of dependable service. However, there are a few things you can do to ensure a long product life. This section will tell you how to care for your freezer properly.

Manual-defrost models

(EV120FX, EV150FX and EV200FX)

Defrost and clean your freezer when frost has built up to about ¼ inch (6 mm) thickness. Complete defrosting and cleaning should be done at least once a year. In high humidity areas, a freezer may need more frequent defrosting and cleaning.

⚠ WARNING

Electrical Shock and Product Damage Hazard

- Turning the Temperature Control to OFF does not remove power to the unit. Failure to unplug the power cord before cleaning or servicing freezer could result in electrical shock.
- Do not place electrical devices in freezer when defrosting. Shock or injury can occur.
- Do not use an ice pick, knife or other sharp-pointed tool to defrost freezer. Damage can occur.
- Do not use abrasive cleaners on your freezer. Do not use cleaning waxes, concentrated detergents, bleaches or cleaners containing petroleum on plastic parts. Damage can occur.

1. Turn Temperature Control to OFF and unplug power cord.
2. Remove all frozen food. Wrap frozen food in several layers of newspaper and cover with a blanket. Food will stay frozen for several hours.

OR

Store frozen food in a cooler, additional refrigerator-freezer, or in a cool area.

3. Remove base grille. (See page 8.)
4. Reach under unit and pull drain hose out through opening. Place a shallow pan under drain hose. Remove drain cap inside freezer.

NOTE: Check drain pan frequently to avoid water overflow. Have a second pan handy for easier emptying of drain pan.
5. Place pans of hot water in freezer with door open to speed melting. Directing air from an electric fan into freezer will also help. Do not place fan in freezer.
6. Use a plastic scraper to remove frost.
7. Wipe water from walls with a towel or sponge.
8. Wash the inside walls with a solution of 2 tablespoons (26 mg) baking soda to 1 quart (0.95 L) warm water.
9. Rinse and dry thoroughly.
10. Use a sponge, cloth or paper towel and mild detergent in warm water to clean outside of freezer, door liner and gasket.
11. Rinse and dry thoroughly.
12. Wax painted metal surfaces outside of freezer to provide rust protection.

NOTE: Do not use wax on plastic parts. Wax may damage them.
13. Replace drain hose, drain cap and base grille.
14. Replace all frozen food.
15. Plug in power cord and refer to "Setting the temperature control" on page 7.

Frost-free models (EV170NX)

Frost-free means that you will never have to defrost your Freezer. Frost is removed by air moving and collecting any moisture and depositing it on the cooling coil. The cooling coil periodically warms up just enough to melt the frost and it then flows down to the drain pan (located behind the base grille) where it is evaporated.

Complete cleaning should be done at least once a year.

1. Turn Temperature Control to OFF and unplug power cord.
2. Remove all frozen food. Wrap frozen food in several layers of newspaper and cover with a blanket. Food will stay frozen for several hours.

OR

Store frozen food in a cooler, additional refrigerator-freezer, or in a cool area.

3. Wash the inside walls with a solution of 2 tablespoons (26 mg) baking soda to 1 quart (0.95 L) warm water.

4. Rinse and dry thoroughly.

5. Use a sponge, cloth or paper towel and mild detergent in warm water to clean outside of freezer, door liner and gasket.

6. Rinse and dry thoroughly.

7. Wax painted metal surfaces outside of freezer to provide rust protection.

NOTE: Do not use wax on plastic parts. Wax may damage them.

8. Replace all frozen food.

9. Plug in power cord and refer to "Setting the temperature control" on page 7.

What to do during power outages

1. Call the power company.

Ask how long power will be off.

2. Keep freezer closed if service is to be interrupted 24 hours or less.

This will help food stay frozen.

3. If service is to be interrupted longer than 24 hours, do this:

Remove all frozen food and store in a frozen food locker.

OR

Place 2 lbs. (0.9 kg) of dry ice in freezer for every cubic foot of freezer space. This will keep foods frozen for 2 to 4 days.

OR

If dry ice or a food locker is not available, use or can perishable food at once.

NOTE: A full freezer stays cold longer than a partly filled one. A freezer full of meat stays cold longer than a freezer full of baked goods.

Food containing ice crystals may be safely refrozen, but the quality and flavor of the food may be affected.

Use refrozen food quickly. If the condition of the food is poor, or you feel it is unsafe to eat, dispose of it immediately.

⚠ WARNING

Personal Injury Hazard

Wear gloves to protect your hands from dry ice burns.

Failure to do so could result in dry ice burns.

Moving care

Remove all frozen food and pack it in dry ice. Unplug the freezer and clean it thoroughly. Tape the door shut and tape electrical cord to the cabinet.

When you get to your new home, refer to pages 4 and 5 for information on installation and setting controls.

IF YOU NEED ASSISTANCE OR SERVICE

If You Need Assistance Or Service

This section is designed to help you save the cost of a service call. Part 1 of this section outlines possible problems, their causes, and actions you can take to solve each problem. Parts 2 and 3 tell you what to do if you still need assistance or service. When calling our Consumer Assistance Center for help or calling for service, please provide a detailed description of the problem, your appliance's complete model and serial numbers and the purchase date. (See page 2.) This information will help us respond properly to your request.

1. Before calling for assistance ...

Performance problems often result from little things you can find and fix without tools of any kind. Please check the chart below for problems you can fix. It could save you the cost of a service call.

PROBLEM	POSSIBLE CAUSE	SOLUTION
The freezer stops running	<p>The power cord is not plugged into a live circuit with the proper voltage.</p> <p>A household fuse has blown or circuit breaker has tripped.</p> <p>The local power has failed.</p> <p>The Temperature Control is set to OFF.</p>	<p>Firmly plug the power cord into a live circuit with the proper voltage.</p> <p>Replace fuse or reset circuit breaker.</p> <p>Wait for power to be restored.</p> <p>Set the Temperature Control to a numbered setting.</p>
The motor seems to run too long	<p>There is excessive frost or a package holding the door open.</p> <p>Large amount of unfrozen food have been added to freezer.</p> <p>The day is hot and muggy or the room is too warm.</p> <p>There is not enough air circulation space around the freezer.</p>	<p>Defrost and clean freezer or move package so door closes properly.</p> <p>The motor will naturally run longer. Add no more unfrozen food at one time than will freeze in 24 hour—approximately 2 to 3 lbs. per cubic foot of freezer space.</p> <p>The motor will run longer to provide the correct amount of cooling.</p> <p>See "Choosing the proper location" on page 6.</p>
The freezer clicks but does not run	<p>The local power has failed.</p>	<p>Unplug the freezer for 30 minutes to allow the refrigeration system to equalize. During this time, keep the door closed whenever possible.</p>

IF YOU NEED ASSISTANCE OR SERVICE

2. If you need assistance ...

Call Whirlpool Consumer Assistance Center telephone number. Dial free from anywhere in the U.S.:

1-800-253-1301

and talk with one of our trained consultants. The consultant can instruct you in how to obtain satisfactory operation from your appliance or, if service is necessary, recommend a qualified service company in your area.

If you prefer, write to:

Mr. William Clark
Consumer Assistance Center
Whirlpool Corporation
2000 M-63
Benton Harbor, MI 49022

Please include a daytime phone number in your correspondence.

3. If you need service ...



Whirlpool has a nationwide network of authorized WhirlpoolSM service companies. Whirlpool service technicians are trained to

fulfill the product warranty and provide after-warranty service, anywhere in the United States. To locate the authorized Whirlpool service company in your area, call our Consumer Assistance Center telephone number (see Step 2) or look in your telephone directory Yellow Pages under:

**• APPLIANCE-HOUSEHOLD-
MAJOR, SERVICE & REPAIR**

- See: Whirlpool Appliances or
Authorized Whirlpool Service
(Example: XYZ Service Co.)

**• WASHING MACHINES &
DRYERS, SERVICE & REPAIR**

- See: Whirlpool Appliances or
Authorized Whirlpool Service
(Example: XYZ Service Co.)

4. If you need FSP[®] replacement parts ...

FSP is a registered trademark of Whirlpool Corporation for quality parts. Look for this symbol of quality whenever you need a replacement part for your Whirlpool appliance. FSP replacement parts will fit right and work right, because they are made to the same exacting specifications used to build every new Whirlpool appliance.

To locate FSP replacement parts in your area, refer to Step 3 above or call the Whirlpool Consumer Assistance Center number in Step 2.

5. If you are not satisfied with how the problem was solved ...

- Contact the Major Appliance Consumer Action Panel (MACAP). MACAP is a group of independent consumer experts that voices consumer views at the highest levels of the major appliance industry.
- Contact MACAP only when the dealer, authorized servicer and Whirlpool have failed to resolve your problem.
Major Appliance Consumer Action Panel
20 North Wacker Drive
Chicago, IL 60606
- MACAP will in turn inform us of your action.

NOTES

NOTES

WHIRLPOOL®

Domestic Freezer Warranty

FZ008

LENGTH OF WARRANTY	WHIRLPOOL WILL PAY FOR
FULL ONE YEAR WARRANTY From Date of Purchase	FSP® replacement parts and repair labor to correct defects in materials or workmanship.
FULL TEN YEAR WARRANTY From Date of Purchase	FSP replacement parts and repair labor to correct defects in materials or workmanship in the sealed refrigeration system. These parts are: 1. Compressor 4. Drier 2. Evaporator 5. Connecting Tubing 3. Condenser
WHIRLPOOL WILL NOT PAY FOR	
A. Service calls to: 1. Correct the installation of the freezer. 2. Instruct you how to use the freezer. 3. Replace house fuses or correct house wiring or plumbing. 4. Replace light bulbs or batteries. B. Pickup and delivery. This product is designed to be repaired in the home. C. Damage to freezer caused by accident, misuse, fire, flood, acts of God or use of products not approved by Whirlpool. D. Food loss coverage for freezers used in commercial applications. E. Repairs to parts or systems caused by unauthorized modifications made to the appliance.	

Limited domestic food loss coverage. See below for details on limited domestic food loss protection plan. Service under the full warranties must be provided by an authorized WhirlpoolSM service company.

WHIRLPOOL CORPORATION SHALL NOT BE LIABLE FOR INCIDENTAL OR CONSEQUENTIAL DAMAGES. Some states do not allow the exclusion or limitation of incidental or consequential damages so this limitation or exclusion may not apply to you. This warranty gives you specific legal rights, and you may also have other rights which vary from state to state.

Outside the United States, a different warranty may also apply. For details contact your authorized Whirlpool distributor or military exchange.

LIMITED DOMESTIC FOOD LOSS COVERAGE REIMBURSEMENT FOR FOOD LOSSES.

During the first year of ownership, the Whirlpool Freezer warranty provides reimbursement as stated below for food actually spoiled while stored in the freezer as a result of defects in materials or workmanship.

During the second through tenth years of ownership, reimbursement will be made as stated below for food actually spoiled while stored in the freezer as a result of a **FAILURE OF THE SEALED REFRIGERATION SYSTEM.**

Food spoilage losses must be verified by Whirlpool or an authorized WhirlpoolSM service company. Reimbursement of losses will be based on domestic use and freezer size up to the total cumulative amount shown for the ten year warranty period.

- 10.0 to 16.0 cubic feetup to \$300.00 maximum payment
- 16.1 cubic feet or largerup to \$400.00 maximum payment

The reimbursement amounts shown may or may not cover the actual replacement cost of the contents of your freezer. They are, however, the maximum payments that will be paid and they are cumulative for the ten year warranty period.

Sorry, but Whirlpool is not responsible for food losses caused by natural spoilage, misuse or negligent care of the freezer, or by accidental or intentional disconnecting of the electrical power cord, power interruption, inadequate power, fire damage, water damage, theft, or riots, strikes, war or acts of God.

If you need service, first see the "Assistance or Service" section of this book. After checking "Assistance or Service," additional help can be found by calling our Consumer Assistance Center telephone number, 1-800-253-1301, from anywhere in the U.S.

PART NO. 2156273

© 1992 Whirlpool Corporation

® Registered Trademark / SM Service Mark of Whirlpool Corporation

Printed in U.S.A.