

use & care guide

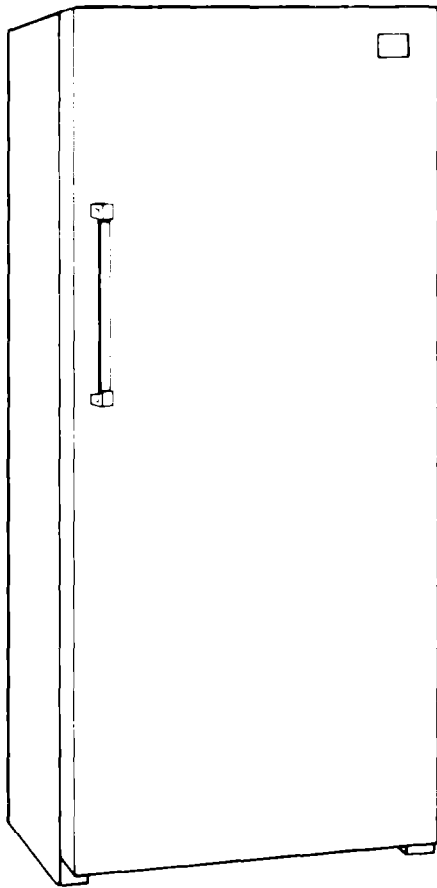

NO-FROST UPRIGHT FREEZER

Model EV130N

s. Freezers, Refrigerator-Freezers, Ice Makers, Dishwashers, Built-In Ovens, and Surface Units, Ranges, Microwave Ovens, Trash Compactors, Room Air Conditioners, Dehumidifiers

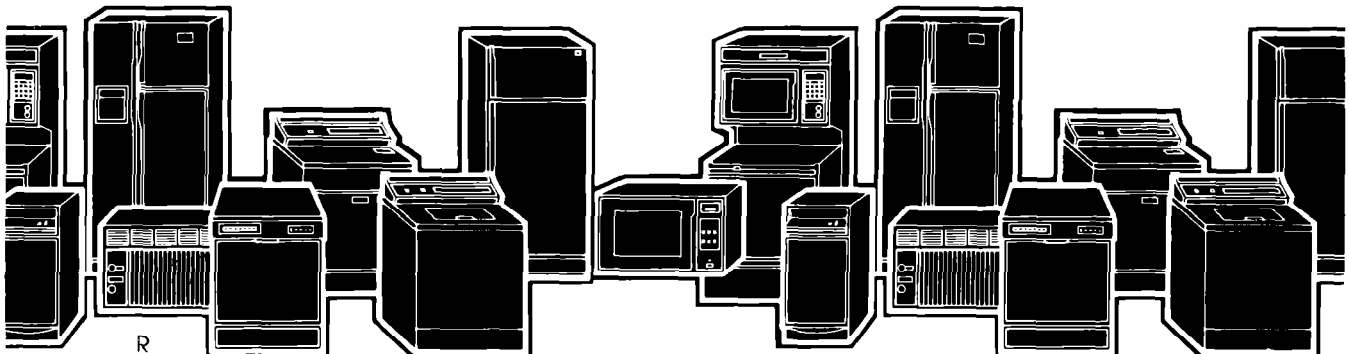

Please read this Use and Care Guide before you do anything else...

This booklet tells you how to start your freezer, defrost it, clean it and adjust controls.

Treat your new freezer with care. Use it only to do what home freezers are designed to do.

Parts and features

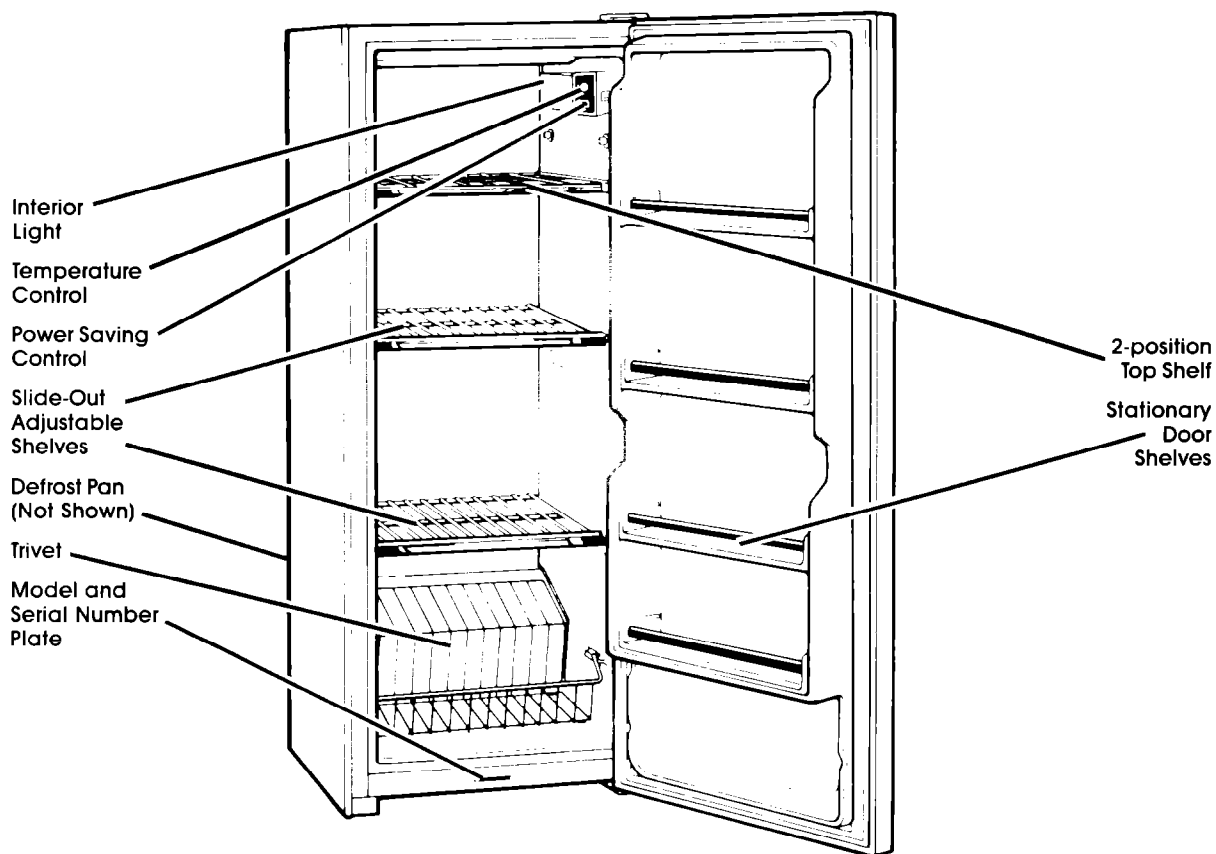

Copy your Model and Serial Numbers here...

When you need service, or call with a question, have this information ready:

1. Complete Model and Serial Numbers from the plate located as shown).

2. Purchase date from sales slip

Copy this information in these spaces. Keep this book, your warranty and sales slip together in a handy place.

Please complete and mail the Owner Registration Card furnished with this product.

Model Number _____

Serial Number _____

Purchase Date _____

Service Company and Telephone Number _____

Contents

	Page		Page
SAFETY FIRST	3	Removing the Bottom Trivet	6
BEFORE YOU PLUG IT IN	3	Energy Saving Tips	6
Install Properly	4	CLEANING YOUR FREEZER	6
Level Freezer	4	Cleaning Chart	7
Remove Sales Labels	4	FREEZING FOOD IN YOUR FREEZER	8
Clean It	4	Packaging and Sealing Food	8
Plug It In	4	To Wrap Foods	8
USING YOUR FREEZER	5	Loading	9
Setting the Temperature Control	5	Storing Frozen Food	9
Adjusting the Temperature Control	5	VACATION AND MOVING CARE	10
Cooling Freezer First	5	IF YOU NEED SERVICE OR ASSISTANCE	11
The Power Saving Control	5	1. Before Calling for Assistance	11
Removing and Adjusting the Top Shelf	5	2. If You Need Assistance	11
Adjusting the Freezer Shelves	5	3. If You Need Service	11
Changing the Light Bulb	6	4. If You Have a Problem	11

© 1986 Whirlpool Corporation

Safety first

Child entrapment and suffocation are not things of the past. Junked or abandoned freezers are still dangerous... even if they will "just sit in the garage a few days."

If you are getting rid of your old freezer, do it safely. Please read the enclosed safety booklet from the Association of Home Appliance Manufacturers. Help prevent accidents.

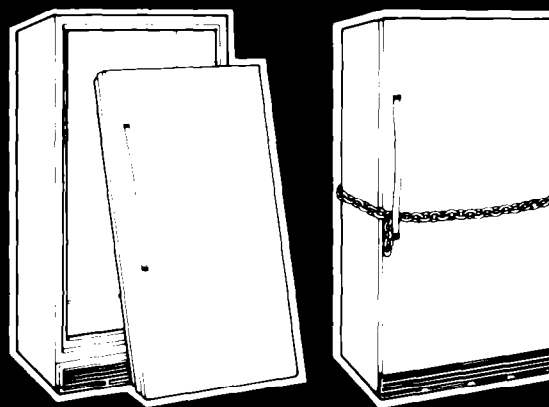

Before you plug it in

IMPORTANT

Before using your freezer, you are personally responsible for making sure that it . . .

- is installed and levelled on a floor that will hold the weight, and in an area suitable for its size and use.
- is connected only to the right kind of outlet, with the right electrical supply and grounding. (Refer to your "Electrical Requirements and Grounding Instructions.")
- is used only for jobs expected of home freezers
- is not near an oven, radiator or other heat source
- is properly maintained.
- is out of the weather.
- is used in an area where the room temperature will not exceed 110°F (43.3°C).
- is not run where there are explosive fumes.
- is not used by those who may not understand how it should be used.
- is not loaded with food before it has time to get properly cold.

Install properly...

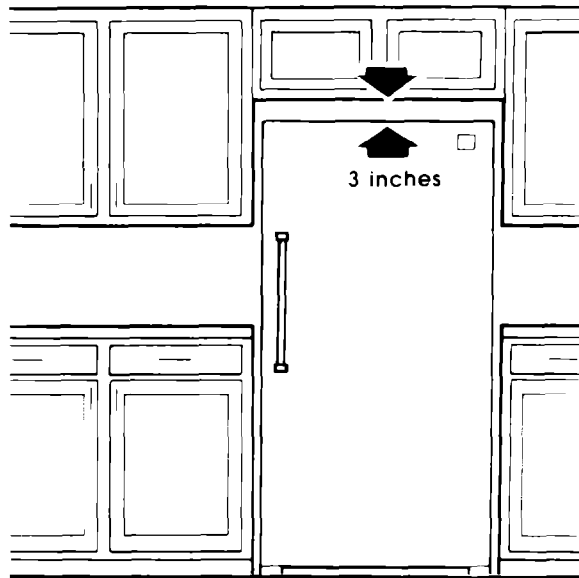

1. Check the strength of the floor. It should hold the weight of a fully loaded freezer.
2. **Pick a safe place, indoors, away from inflammables such as gasoline.**
3. Allow 3 inches (7.5 cm) air space on top of freezer for proper ventilation.
4. Allow at least an inch (2.5 cm) between the freezer condenser, on the back of the unit, and the wall.
5. Allow 1/2 inch (1.25 cm) on each side of the freezer for ease of installation.
6. If the freezer is to be against a wall, you might want to leave extra space on the hinge side so the door can be opened wider.
7. The four bolts that held your freezer in the shipping crate are designed to be the levelling legs. Screw the legs far enough into the bolt holes, in each of the four bottom corners, so the freezer stands about 1 inch (2.5 cm) off the floor.

Level freezer...

so the door will stay open at any position:

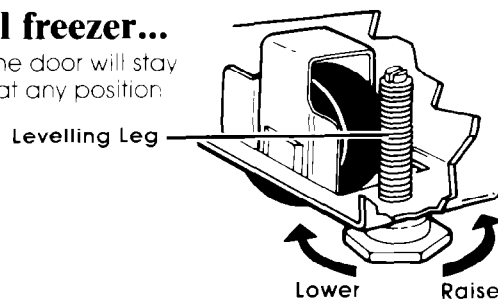

Start adjustment with the door hinge side.

1. Slide freezer into place
2. Adjust front legs to level the freezer.
 - To raise front, turn legs in direction shown.
 - To lower front, turn legs in direction shown.
3. Check with level.
4. After freezer is fully loaded, recheck with level

Remove sales labels...

Remove the Consumer Buy Guide label and any **inside** labels before using the freezer.

To remove any remaining glue:

1. Rub briskly with thumb to make a ball, then remove.

OR

2. Soak area with dishwashing detergent solution (1 teaspoon detergent in 1 quart warm water) before removing glue as described in step 1.

DO NOT USE rubbing alcohol or flammable or toxic solvents, such as acetone, gasoline, carbon tetrachloride, etc. These can damage the material.

NOTE: DO NOT REMOVE the Tech Sheet fastened under the freezer at the front.

Clean it...

Clean your freezer before using it. See cleaning instructions on page 6.



Plug it in...

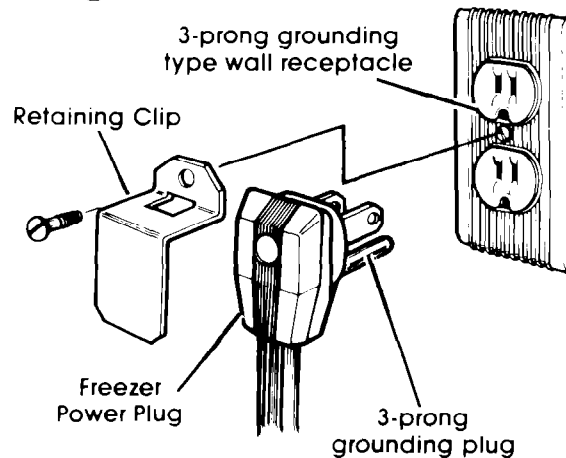

Recommended Grounding Method

A 115 Volt, 60 Hz., AC only 15 or 20 ampere fused and properly grounded electrical supply is required. It is recommended that a separate circuit serving only this appliance be provided.

Do not use an extension cord. Use a receptacle which cannot be turned off with a switch or pull chain. See individual electrical requirements and grounding instruction sheet in your literature package.

Using your freezer

Setting the temperature control...

To start, turn control to the middle of the dial. This setting is designed to maintain the temperature at or near 0°F (-17.8 °C) under normal operating conditions.

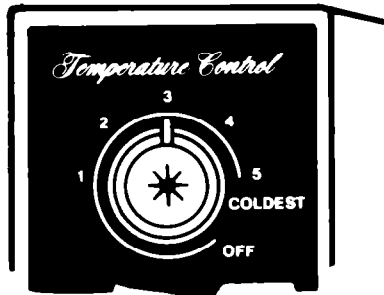

Adjusting the temperature control...

1. Turn control to higher number for colder temperatures.
2. Turn to lower number for less cold temperatures.

Cooling freezer first...

1. Allow freezer to cool 6 to 8 hours before filling with **frozen food**.
2. Let it cool overnight before adding large amount of **unfrozen food**.

Note: When freezer is first started, the compressor will run constantly until the cabinet is cooled. It may take up to 6 to 8 hours or longer, depending on room temperature and the number of times the freezer door is opened.

After the cabinet is cooled, the compressor will turn ON and OFF as needed to keep the freezer at the proper temperature.

The Power Saving Control...

operates electric heaters. These heaters help prevent moisture from forming on the outside of the freezer when humidity is high.

Use the OFF setting to save energy when humidity is low.

Use the ON setting only if moisture forms on the outside of the freezer.

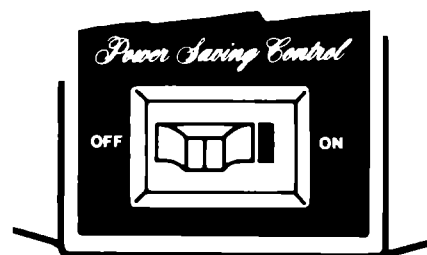

Removing and adjusting the top freezer shelf...

To remove shelf:

1. Lift front, then back off supports.
2. Replace in reverse order.

To adjust shelf:

1. Remove shelf.
2. Remove supports by sliding upwards.
3. Replace supports on desired level.
4. Replace shelf.

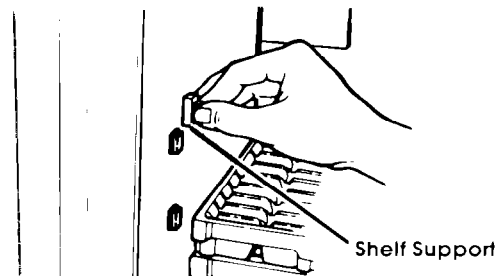

Adjusting the freezer shelves...

To remove shelf:

1. Remove food from shelf.
2. Slide shelf straight out to stop.
3. Lift front.
4. Slide the rest of the way out.

To replace shelf:

1. Fit back of shelf on top of guides with wire stops on bottom of guides.
2. Lift front, then slide shelf until it clears the guide stops.

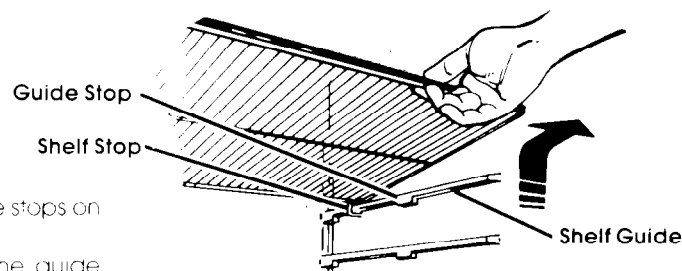

Changing the light bulb...

Light Shield

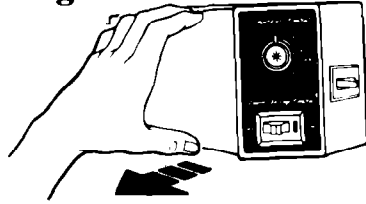

WARNING: To avoid possible shocks, first unplug freezer or turn off electricity leading to freezer at the main power supply.

- 1 Remove the light shield from the side of the control panel. Depress the back of the shield to release the tabs, then pull away.
- 2 Replace bulb with a 40-watt appliance bulb.
- 3 Replace the light shield. Insert the shield tabs in the slots, then press the shield to snap into place.
- 4 Plug in power cord or switch on electricity.

Removing the bottom trivet...

To remove:

1. Lift front of trivet out of supports.
2. Pull out

Lift the Front,
Then Pull Out

To replace:

1. Position back of trivet on the rear wall supports
2. Lower front into place.

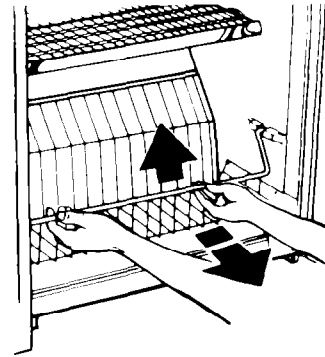

Energy saving tips...

You can help your freezer use less electricity

- Check door gasket and level freezer to assure a good door seal.
- Clean the condenser coils regularly.
- Keep door openings to a minimum. Remove several items at one time. Keep contents organized to eliminate searching.
- Fill to capacity. Follow recommended procedures for freezing foods. See pages 8 and 9.
- Set Temperature Control to provide temperatures around 0 F (-17.8 °C). There is no need to store foods below 0 F.
- Keep door locked to ensure door closure.
- Do not let frost build up to more than 1/8 inch (6 mm) thick. Efficiency is reduced.
- Keep Power Saving Control on OFF when humidity is low.

Cleaning your freezer

This freezer is a No-Frost model and defrosts automatically. Complete cleaning, however, should be done at least once a year.

To clean:

1. Turn Temperature Control to OFF
2. Unplug power cord.
3. Take out all food.

Note: Wrap frozen foods and packages in several layers of newspaper and cover with a blanket. Food will stay frozen for several hours.

4. Remove shelves and trivet
5. Clean freezer according to the following directions

After cleaning:

1. Replace shelves and trivet.
2. Plug in power cord.
3. See directions for "Setting the Temperature Control," page 5.

WARNING: When moving the freezer, wipe up any water that may have spilled from the defrost pan. Spilled water can cause slipping and injury.

Cleaning chart...

Part	What to use	How to clean
Removable parts (shelves, trivet, etc.)	Sponge or cloth; mild detergent and warm water.	<ul style="list-style-type: none"> • Wash with warm water and a mild detergent. • Rinse and dry.
Outside	Sponge, cloth or paper towel; mild detergent; appliance wax (or good auto paste wax)	<ul style="list-style-type: none"> • Wash with warm water and a mild detergent. Do not use abrasive or harsh cleansers. • Rinse and dry. • Wax painted metal surfaces at least twice a year with appliance wax or a good auto paste wax. Apply wax with a clean, soft cloth. Do not use wax on plastic parts. <p>Waxing painted metal surfaces provides rust protection.</p>
Inside walls (Freezer should be allowed to warm up so cloth won't stick.)	Sponge, soft cloth or paper towel, baking soda, warm water, mild detergent.	<ul style="list-style-type: none"> • Wash with warm water and - mild detergent or baking soda [2 tablespoons [26 g] to 1 quart [.95 l] warm water. • Rinse and dry.
Door liner and gasket	Sponge, soft cloth or paper towel, mild detergent, warm water	<ul style="list-style-type: none"> • Wash with mild detergent and warm water. • Rinse and dry. <p>DO NOT USE Cleaning waxes, concentrated detergents, bleaches or cleansers containing petroleum on plastic parts.</p>
Defrost pan (behind freezer on top of compressor)	Sponge, soft cloth or paper towel, mild detergent and warm water.	<ul style="list-style-type: none"> • Slide freezer out away from wall. • Wash defrost pan with warm water and mild detergent. Do not remove defrost pan to clean. • Rinse and dry. • Make sure defrost drain tube points into pan. • Slide freezer back into place.
Condenser coils	Use vacuum cleaner with brush attachment. WARNING: Watch out for sharp wire ends at top of condenser coils. They can cause injury or damage brush.	<ul style="list-style-type: none"> • Slide freezer out away from the wall. • Clean dust and lint from condenser coils behind the freezer at least every other month.

Freezing food in your freezer

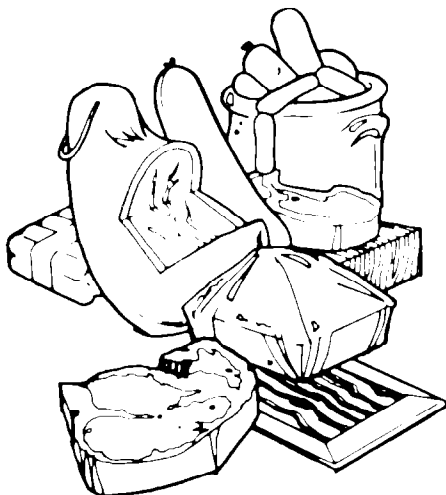

When freezer has cooled to a safe storage temperature, it may be loaded with **frozen food**.

When you plan to freeze **unfrozen food**, see the following chart for the amount to freeze at **one time**.

POUNDS OF FOOD TO FREEZE AT ONE TIME*		
Size of Freezer	Meat or Fish	Vegetables or Fruit
13 cu. ft. (368 L)	26 lbs. (11.7 kg.)	39 lbs. (17.5 kg.)

*These amounts are based on USDA recommendations. If too many packages of unfrozen food are packed at one time into the freezer, the rate of freezing is too slow. Poor quality products result.

Packaging and sealing food...

Airtight packaging is important in freezing foods. Containers and wrappings should be moisture and vapor proof and packages should be sealed carefully to keep moisture in and air out.

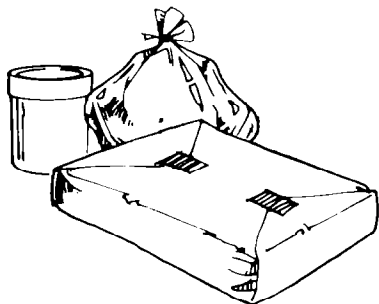

Freezer burn can result if food is not properly wrapped. When this happens, food dehydrates and is of poor quality.

To wrap foods...

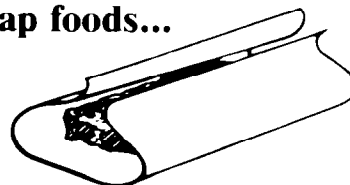

1. Cut sheet of wrapping material about one-third longer than distance around food to be wrapped. Place wrapping sheet on flat surface with food in center of sheet.

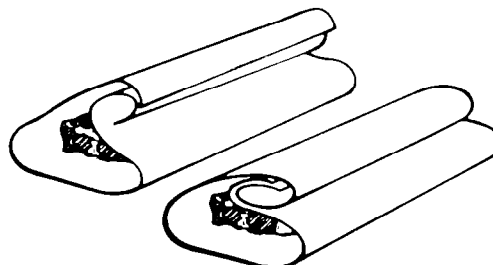

2. Bring front and back of wrapping together and fold in toward food, making at least two one inch (2.5 cm) folds until food fits tightly against wrapping.

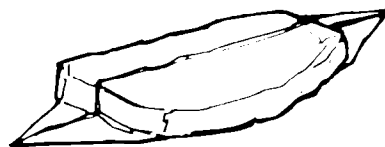

3. Crease ends close to food to eliminate air pockets.

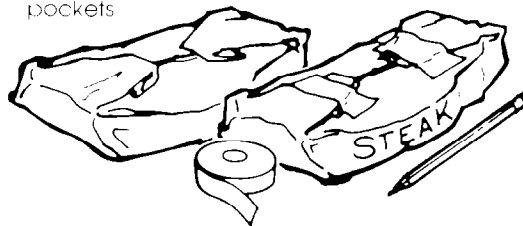

4. Press all air from package. Fold each end over twice. Make sure fold is tight and fasten against end of package with freezer tape.

NOTE: When packaging meats that have not been boned, pad sharp edges with extra wrap or use stockinette to protect against tearing or puncturing.

Use heavy-duty aluminum freezer foil, kraft paper with cellophane bonded to it, special freezer bags, jars, cartons and freezer sealing tape for packaging your food items. You'll find them at the supermarket or freezer dealer.

See the "Freezer Guide" for complete information and tips on home freezing.

Loading...

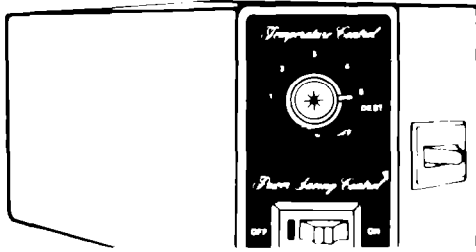

1. Before freezing large quantities of food, turn Temperature Control to highest setting and let freezer operate for several hours. **After loading all food items, return Temperature Control to the usual setting.**

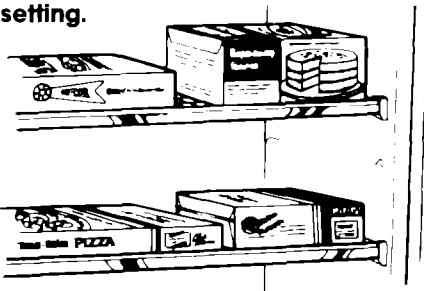

2. To speed freezing, lay packages in a single layer so each rests on the surface of a shelf. Leave space between packages.
3. Add more unfrozen food after first load is frozen (approximately 18 to 24 hours)

Storing frozen food...

After food is frozen, stack packages anywhere in the freezer. Packages should not extend beyond the shelf edge or they may keep the door from closing and sealing properly.

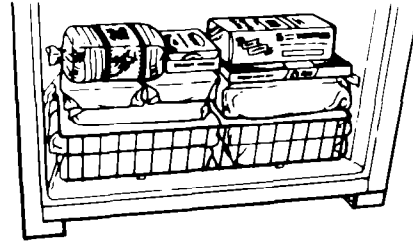

Trivet – Store heavy and bulky packages here. Trivet should be in place at all times for proper air circulation.

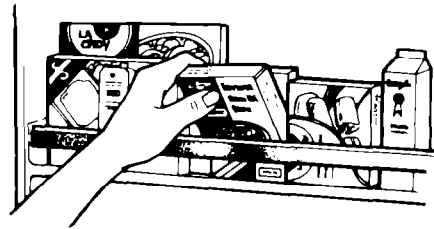

Door storage – Store packages on the door shelves behind the retaining bar.

Vacation and moving care

Vacations...

Arrange for someone to make regular checks of your freezer to make sure it is operating and electricity has not been interrupted.



Shutting off and moving...

If freezer is shut off for more than 24 hours:

1. Remove and store all food.
2. Unplug freezer.
3. Clean thoroughly. See "Cleaning your freezer," page 6.
4. Block door open for air circulation. Turn lock to locked position with door open. Place blocks between door and cabinet and tape in place with self-adhesive filament tape.

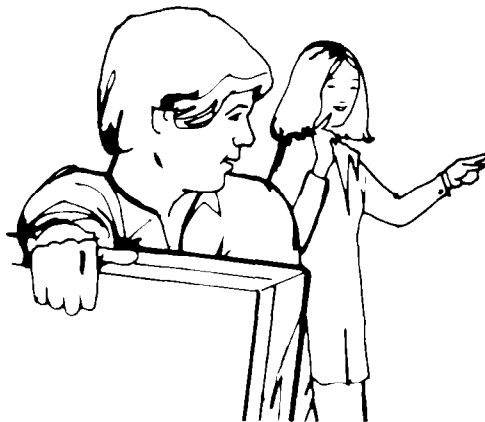

If you move the freezer:

1. Remove shelves and trivet
2. Tape doors shut.
3. **Do not place objects inside cabinet.**
4. Level properly to ensure good door seal.

WARNING:

Do not allow children near the freezer when the door is blocked open. They may become injured or trapped.

When moving the freezer, clean up any water that may have spilled from the defrost pan. Spilled water can cause slipping and injury.

To restart freezer, see "Using your freezer," page 5.

If you need service or assistance, we suggest you follow these four steps:

1. Before calling for assistance...

Performance problems often result from little things you can find and fix yourself without tools of any kind.

If the electricity goes off:

Learn how long the power will be off by calling the power company.

- If service is to be interrupted 24 hours or less, keep the freezer closed. Most food will stay frozen.
- If service is to be interrupted longer than 24 hours, do this:
 1. Remove all unfrozen food and store in a frozen food locker. **OR...**
 2. Place 2 lbs. (0.9 kg) of dry ice in freezer for every cu. ft. of freezer space. This will keep frozen foods for 2 to 4 days. Wear gloves to protect your hands from dry ice burns.
 3. If neither food locker storage or dry ice is available, use or can perishable food at once.
- The length of time food will stay frozen depends on several factors. For instance: a full freezer will remain cold longer than a freezer partially filled. And a freezer full of meat will stay cold longer than a freezer filled with baked goods. Also, if the food still contains ice crystals, it may be safely refrozen, although the quality and flavor may be affected. Use this food as soon as convenient. If the condition of the food is poor or is in any way questionable, it is wise to dispose of it.

If your freezer stops running:

- Is the power supply cord plugged into a live circuit with the proper voltage? (See page 4.)
- Have you checked your home's main fuses or circuit breaker box?
- Is the Temperature Control turned ON?

If the compressor seems to run too long:

- Is the condenser, located on the back of the freezer, free of dust and lint?
- Is there enough air circulation space above and in back of the freezer?
- On hot summer days or if the room is hot, the compressor will run longer to provide the correct amount of cooling.
- If large amounts of unfrozen food have been put into the freezer, the compressor will run longer.



FSP is a registered trademark of Whirlpool Corporation for quality parts. Look for this symbol of quality whenever you need a replacement part for your Whirlpool appliance. FSP replacement parts will fit right and work right, because they are made to the same exacting specifications used to build every new Whirlpool appliance.

2. If you need assistance*...

Call Whirlpool **COOL-LINE®** service assistance telephone number. Dial free from:

Continental U.S. (800) 253-1304
 Michigan (800) 632-2243
 Alaska & Hawaii (800) 253-1121

and talk with one of our trained Consultants. The Consultant can instruct you in how to obtain satisfactory operation from your appliance or, if service is necessary, recommend a qualified service company in your area.

3. If you need service*...



Whirlpool has a nationwide network of franchised TECH-CARE® Service Companies. TECH-CARE service technicians are trained to fulfill the product warranty and provide after-warranty service, anywhere in the United States. To locate TECH-

CARE service in your area, call our COOL-LINE service assistance telephone number (see Step 2) or look in your telephone directory Yellow Pages under:

APPLIANCES – HOUSEHOLD- MAJOR – SERVICE & REPAIR	ELECTRICAL APPLIANCES- MAJOR – REPAIRING & PARTS
OR	
WHIRLPOOL APPLIANCES FRANCHISED TECH-CARE SERVICE	WHIRLPOOL APPLIANCES FRANCHISED TECH-CARE SERVICE
SERVICE COMPANIES	
XYZ SERVICE CO 123 Maple	999-9999
OR	
WASHING MACHINES, DRYERS & IRONERS – SERVICING	
WHIRLPOOL APPLIANCES FRANCHISED TECH-CARE SERVICE	
SERVICE COMPANIES	
XYZ SERVICE CO 123 Maple	999-9999

4. If you have a problem*...

Call our COOL-LINE service assistance telephone number (see Step 2) and talk with one of our Consultants, or if you prefer, write to:

Mr. Robert Stanley
 Division Vice President
 Whirlpool Corporation
 2000 US-33, North
 Benton Harbor, MI 49022

*If you must call or write, please provide: model number, serial number, date of purchase, and a complete description of the problem. This information is needed in order to better respond to your request for assistance.



Making your world a little easier.

Part No. 1110535
©1986 Whirlpool Corporation

Printed in U.S.A.

Makers: Dishwashers, Built-In Ovens and Surface Units, Ranges, Microwave Ovens, Trash Compactors, Room Air Conditioners, Dehumidifiers, Automatic Washers, Clothes Dryer

