



CV 270 A  
CV 270 AP

en  
it

Instruction Manual  
Manuale di istruzioni



## en-Index

1-9

---

|   |    |
|---|----|
| Safety first !.....                     | /1 |
| Transport instructions .....            | /2 |
| Disposal.....                           | /2 |
| Appliance Setup .....                   | /2 |
| Get to know your appliance .....        | /3 |
| Prior to startup .....                  | /4 |
| Setting the operating temperature ..... | /4 |
| Cooling .....                           | /5 |
| Defrosting of the appliance .....       | /5 |
| Replacing the interior light bulb ..... | /5 |
| Cleaning and care .....                 | /6 |
| Practical tips and notes .....          | /6 |
| Examples of use .....                   | /7 |
| Normal operating noises .....           | /7 |
| What, if.... ..                         | /8 |
| Reversing the doors .....               | /8 |
| Meaning of energy fiche.....            | /9 |

## it-Indice

1-9

---

|  |    |
|--|----|
| Innanzitutto la sicurezza! .....                         | /1 |
| Istruzioni per il trasporto .....                        | /2 |
| Smaltimento.....   | /2 |
| Installazione dell'elettrodomestico .....                | /2 |
| Conoscere l'elettrodomestico .....                       | /3 |
| Prima dell'avvio.....                                    | /3 |
| Impostazione della temperatura di<br>funzionamento ..... | /4 |
| Spie .....   | /4 |
| Congelamento .....                                       | /5 |
| Sbrinamento dell'elettrodomestico .....                  | /5 |
| Pulizia e manutenzione .....                             | /6 |
| Suggerimenti pratici e note .....                        | /7 |
| Rumori normali durante il funzionamento .....            | /7 |
| Cosa fare, se.... ..                                     | /8 |
| Inversione dello sportello .....                         | /8 |
| Significato della scheda sull'energia.....               | /9 |

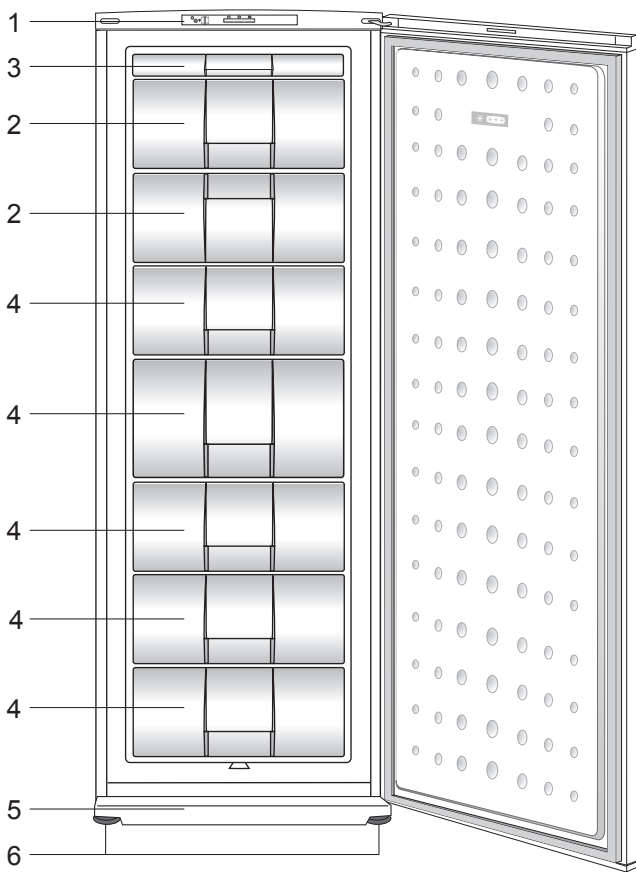

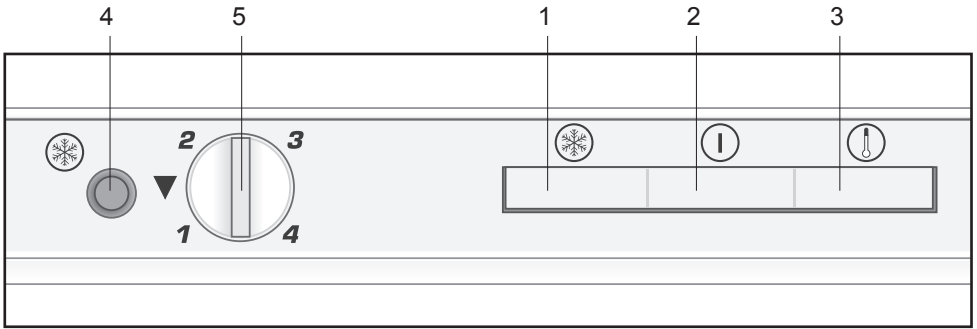

2

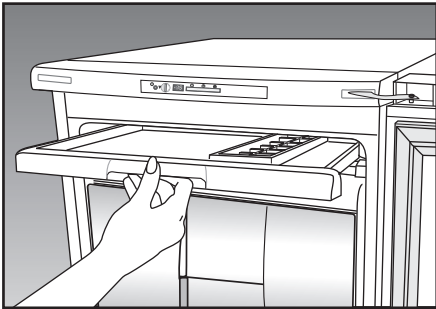

3

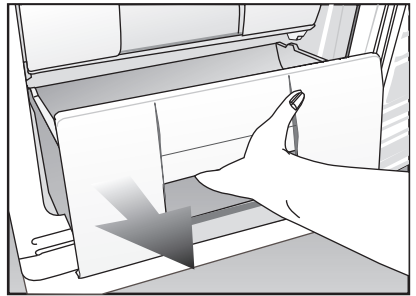

4

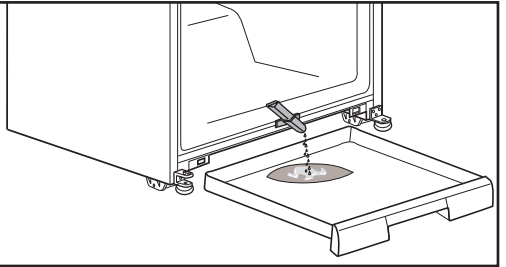
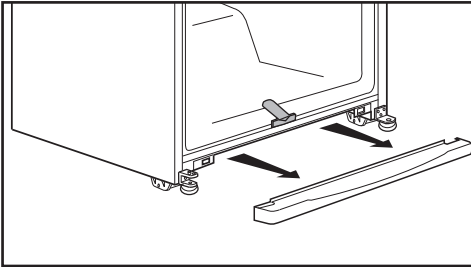

5

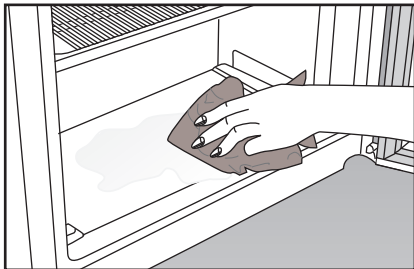

6

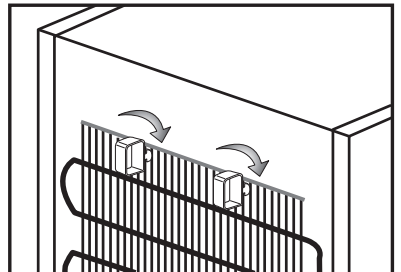

7

(16)

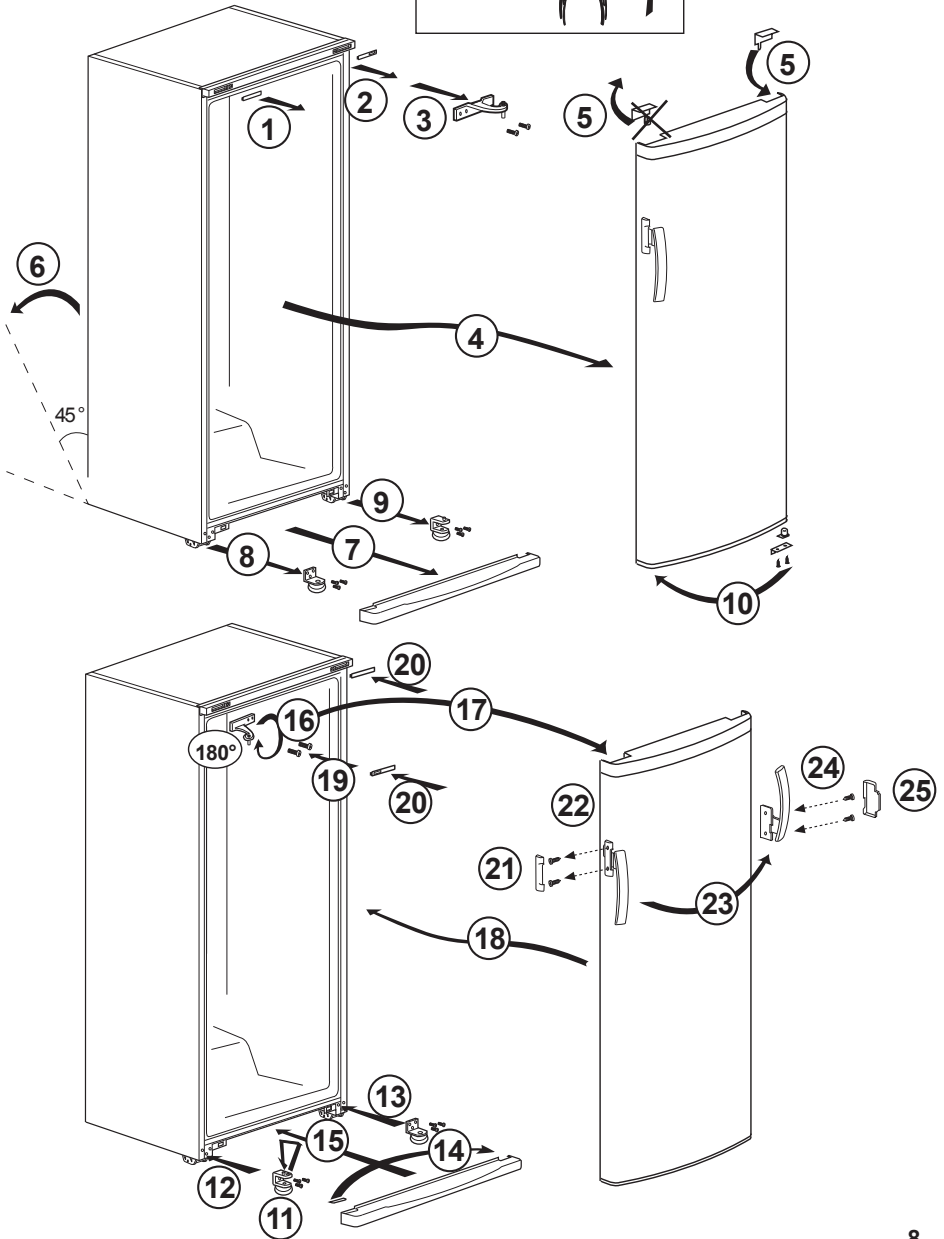
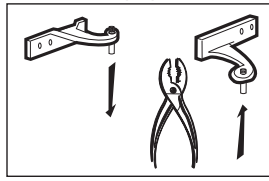

Congratulations on your choice of our product which will certainly provide you with many years of good service.

## Safety comes first!

Please read this Instruction Manual carefully. It contains important information on how to use your new appliance. If instructions are not adhered to, you may lose your right to service at no charge during the warranty period. Please keep this manual in a safe place and pass it on to later users if applicable.

- Do not connect your appliance to the power supply until all packing and transit protectors have been removed.
- Leave to stand upright for at least 4 hours before switching on to allow the system to settle if transported horizontally.
- This appliance must only be used for its intended purpose, i.e. the storing and freezing of edible foodstuff.
- We do not recommend use of this appliance in an unheated, cold room e.g. garage, conservatory, annex, shed, outdoors, etc. See 'Location'.
- On delivery, check to make sure that the product is not damaged and that all the parts and accessories are in perfect condition.
- Do not operate a damaged appliance; if in doubt, check with your dealer.
- Do not allow children to play with the appliance.
- Do not sit or stand on or let the children sit or stand on the appliance or on the pull-out parts.
- Do not hang on the appliance door.
  
- Your appliance contains no fluoridated coolants (CFC/HFC), but isobutane (R 600 a), a natural gas which is highly compatible with the environment. (R 600 a) is easily flammable. Therefore, be sure that the cooling circuit is not damaged either during transport or during operations.
  - In the event of damage;
    - Avoid any open flame, sources of sparks and flammable substances.
    - Immediately air the room in which the appliance is located.
    - In case the coolant spraying out contacts your eyes it may cause eye injuries.
- The space in the room where the appliance is installed must not be smaller than 10 cubic metres.
  
- Do not dispose of the appliance in a fire. Your appliance contains non CFC substances in the insulation which are flammable.
- Please contact the local authority in your region for information on disposal methods and facilities available.

⚠ **Warning** - Keep ventilation openings on the appliance enclosure or in the built-in structure, clear of obstruction.

⚠ **Warning** - Do not use mechanical devices or other means to accelerate the defrosting process, other than those recommended by the manufacturer.

⚠ **Warning** - Do not damage the refrigerant circuit.

⚠ **Warning** - Do not use electrical devices inside the food storage compartments of the appliance, unless they are of the type recommended by the manufacturer.

- Avoid touching the metal condenser wiring on the backside of the appliance; there is risk of injury.
- In the event of a possible malfunction, disconnect the appliance from the power supply first.
- Prior to cleaning the appliance always unplug the appliance or switch off the circuit breaker. Do not pull from the power cable. Pull from the plug.
- Repairs to the electrical equipment may only be made by qualified experts. If the power cable is damaged, the manufacturer or customer service must replace it in order to avoid danger.

## Transport instructions

The appliance should be transported only in upright position.

The packing as supplied must be intact during transportation.

If the appliance is transported in the horizontal position, it must be placed vertically and left in this position for 4 hours before taking into operation.

The appliance must be protected against rain, moisture and other atmospheric influences.

The manufacturer assumes no liability if safety instructions are disregarded.

## Disposal

Make the appliance unusable immediately. Pull out the mains plug and cut the power cable. Remove or destroy snap or latch locks before disposing of the appliance. In this manner you prevent children from locking themselves in and endangering their lives.

## Appliance setup

- Do not operate your appliance in a room where the temperature is likely to fall below 10 °C at night and/or especially in winter. At lower temperatures the appliance may not operate, resulting in a reduction in the storage life of the food.

- The climate class rate of your appliance is given on the rating label located inside the appliance. It specifies the appropriate operating ambient temperatures as explained below.

Climatic class      Ambient temperatures

|             |                 |
|-------------|-----------------|
| SN.....     | +10 °C to 32 °C |
| N .....     | +16 °C to 32 °C |
| ST .....    | +18 °C to 38 °C |
| T.....      | +18 °C to 43 °C |
| SN-ST ..... | +10 °C to 38 °C |
| SN-T .....  | +10 °C to 43 °C |

## Location

Only place the appliance in dry rooms which can be ventilated.

Avoid direct sunlight or direct heat sources such as a stove or a heater.

If this cannot be avoided, the following minimum distances should be maintained:

From cookers                   :3.00 cm

From heaters                   :3.00 cm

From cooling devices         :2.50 cm

- Make sure that sufficient room is provided around the appliance to ensure free air circulation.

Fit the two plastic wall spacers supplied with the appliance rotating 1/4 turn to the condenser at the back of the appliance (Fig. 7).

- The appliance should be located on a level surface. The two front feet can be adjusted as required. To ensure that your appliance is standing upright adjust the two front feet by turning clockwise or counter-clockwise, until the product is in firm contact with the floor. Correct adjustment of feet avoids excessive vibration and noise.

## Electrical connections

### Warning

This appliance must be grounded.

- Check whether the power type and voltage in your region corresponds to the one stated on the rating label inside the appliance.
  - The electrical safety of the appliance is only assured when the grounding system in the house is installed in accordance with regulations.
- When placing the appliance, do not let the power cable get stuck under it; otherwise the cable will be damaged.
- Ensure that the plug remains readily accessible. Do not use a multiple adapter bar or an extension cable.
- The electrical specifications of your appliance is given on the rating label located inside the appliance.
- Route power cable to allow easy connection and disconnection after installation.
- A contact separator should be used if the power cable is not accessible. (for built-in models)

## Get to know your appliance **Prior to startup**

### **Warning**

Below information about accessories are supplied only for reference. Below accessories may not be exactly same as the accessories of your appliance.

#### **Fig. 1**

1. Control Panel
2. Flap (Fast-Freeze compartment)
3. Ice cube tray & Ice bank
4. Drawers
5. Air grille
6. Adjustable front feet

Before you start operating your appliance, the following points should be re-checked for safety:

- Is the appliance standing level on the floor?
- Is there sufficient space for good air circulation?
- Is the interior clean? (Also see the section 'Cleaning and care')
- Set the thermostat knob half way between 1 and 4 or Min. and Max.
- Now connect the appliance to the mains.

Do not place foodstuff into the refrigerator until the temperature has reached the desired level.



## Setting the operating temperature

(Fig. 2)

The operating temperature is regulated by the temperature control.

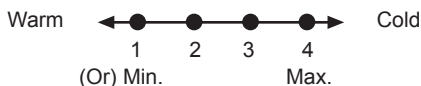

1 = Lowest cooling setting (Warmest setting)

4 = Highest cooling setting (Coldest setting)

(Or)

Min. = Lowest cooling setting  
(Warmest setting)

Max. = Highest cooling setting  
(Coldest setting)

Please choose the setting according to the desired temperature.

The interior temperature also depends on ambient temperature, the frequency with which the door is opened and the amount of foods kept inside.

Frequently opening the door causes the interior temperature to rise.

For this reason, it is recommended to close the door again as soon as possible after use.

The normal storage temperature of your appliance should be  $-18\text{ }^{\circ}\text{C}$  ( $0\text{ }^{\circ}\text{F}$ ). If the thermostat knob is turned counter clockwise from position 1, the appliance will be switched off and “click” sound will be heard. Lower temperatures can be obtained by adjusting the thermostat knob towards Position 4.

We recommend checking the temperature with a thermometer to ensure that the storage compartments are kept to the desired temperature. Remember to take the reading immediately since the thermometer temperature will rise very rapidly after you remove it from the freezer.

## Indicator lights

There are three coloured indicator lights located inside the appliance which show the operating mode of the freezer (Fig. 2).

### Amber Indicator (1)

Illuminates when the fast-freeze switch (4) is turned on and stays on until the fast freeze operation is deactivated manually.

Fast-freeze operation is for freezing fresh food (see Freezing Fresh Food section).

### Green Indicator (2)

Illuminates when the appliance is connected to the mains and will glow as long as there is electricity present. The green indicator does not give any indication of the temperature inside the freezer.

### Red Indicator (3)

Illuminates

- When the appliance is first switched on, and will stay on until the pre-set temperature has been attained.
- If the appliance is overloaded with fresh food.
- If the appliance door is left open accidentally.

### Thermostat knob (5)

The thermostat knob is located on the indicator light frame.

Important:

When you press the fast-freeze switch or adjust the set temperature, there may be a short delay before the compressor starts to operate. This is normal and not a compressor fault.

## Freezing

### Freezing food

The freezing area is marked with  symbol on the door liner.

You can use the appliance for freezing fresh food as well as for storing pre-frozen food.

Please refer to the recommendations given on the packaging of your food.

#### Attention

Do not freeze fizzy drinks, as the bottle may burst when the liquid in it is frozen.

Be careful with frozen products such as coloured ice-cubes.

Do not exceed the freezing capacity of your appliance in 24 hours. See the rating label. In order to maintain the quality of the food, the freezing must be effected as rapidly as possible. Thus, the freezing capacity will not be exceeded, and the temperature inside the freezer will not rise.

#### Attention

Keep the already deep-frozen food always separated with freshly placed food.

When deep-freezing hot food, the cooling compressor will work until the food is completely frozen. This can temporarily cause excessive cooling of the refrigeration compartment.

If you find the freezer door difficult to open just after you have closed it, don't worry. This is due to the pressure difference which will equalize and allow the door to open normally after a few minutes.

You will hear a vacuum sound just after closing the door. This is quite normal.

### Making ice cubes

Fill the ice-cube tray 3/4 full with water and place it in the freezer.

As soon as the water has turned into ice, you can take out the ice cubes.

Never use sharp objects such as knives or forks to remove the ice cubes. There is a risk of injury!

Let the ice cubes slightly thaw instead, or put the bottom of the tray in hot water for a short moment.

### Fast freeze

If large amounts of fresh food are going to be frozen, push the fast freeze switch 24 hours before putting the fresh food in the fast freeze compartment.

It is strongly recommended to keep fast freeze switch on at least 24 hours to freeze maximum amount of fresh food declared as freezing capacity. Take special care not to mix frozen food and fresh food.

### Defrosting of the appliance

Excessive build-up of ice will affect the freezing performance of your appliance.

It is therefore recommended that you defrost your appliance at least twice a year, or whenever the ice build-up exceeds 7 mm. Defrost your appliance when there is only little or no food in it.

Take out the deep-frozen food from the drawers. Wrap the deep-frozen food in several layers of paper, or a blanket, and keep it in a cold place.

Unplug the appliance or switch off the circuit breaker to start the defrosting process.

Take out the accessories (like shelf, drawer etc.) from the appliance (**Fig. 4-5**) and use a suitable container to collect the thawing water.

Use a sponge or a soft cloth to remove thawing water if necessary (**Fig. 6**).

Keep the door open during defrosting.

For quicker defrosting, place containers with warm water inside the appliance.

Never use electrical devices, defrosting sprays or pointed or sharp-edged objects such as knives or forks to remove the ice.

After the defrosting is done, clean the inside (see the section 'Cleaning and care').

Reconnect the appliance to the mains. Place the frozen food into the drawers and slide the drawers into the freezer.

## Cleaning and care

### Interior and Exterior Surfaces

#### Attention

Always unplug the power cable or switch off the circuit breaker before cleaning.

Clean the exterior using lukewarm water and a mild detergent.

Never use detergents, abrasive or acidic agents.

Wipe the inside compartment dry.

Be careful to prevent water from getting into contact with the electrical connections of the temperature control or the interior light.

If the appliance is not going to be used for a long period of time, unplug the power cable and remove all food. Clean the appliance and keep the door open.

To preserve the appearance of your appliance, you can polish the exterior and the door accessories with a silicone wax.

Clean the condenser at the back of the appliance once a year using a brush or a vacuum cleaner. Dust build-up leads to increased energy consumption.

Inspect the door gasket at regular intervals. Clean with water only, and wipe totally dry.

### Cleaning of the accessories

Drawers:

To clean a drawer, pull it out as far as possible, tilt it upwards and then pull it out completely.

## Practical tips and notes

### Freezing

- Always leave food to thaw in a container that allows the thawing water to run off.
- Do not exceed the maximum allowable freezing capacity when freezing fresh food (see the section "Freezing")
- Do not give children ice-cream and ices directly from the freezer.

The low temperature may cause cold burns on lips.

- Never re-freeze defrosted food; defrosted food must be consumed within 24 hours. Only food that has been cooked can be refrozen.
- Do not take out frozen food with wet hands.
- Store only fresh and impeccable food.
- Always use appropriate packaging material to avoid odour penetration or degradation of the food.
- Store commercially frozen food in accordance with the instructions given on the packaging.
- Freeze cooked food in small quantities. This ensures rapid freezing and maintains the quality of the food.
- Do not freeze liquids in tightly closed bottles or containers.

The bottles/containers may burst at low temperatures.

- Carry pre-frozen food in suitable bags and place it in your freezer as soon as possible. Always defrost food in the fridge compartment.

## Normal operating noises

Various functional noises are completely normal due to the operation of the cooling system of your appliance;

- Gurgling, hissing, boiling or bubbling noises are caused by the refrigerant, circulating inside the cooling system. These noises can still be heard for a short period of time after the compressor shuts off.

- Sudden, sharp cracking or popping noises are caused by the expansion and contraction of the inside walls or some components inside the cabinets.

- Buzzing, whirring, pulsating or high-pitched humming noises are caused by the compressor. These noises are slightly louder at the start-up of the compressor and reduce when the appliance reaches the operating temperatures.

Also to avoid disturbing vibrations and noises make sure that;

- Your refrigerator is standing level on all four feet.

- Your refrigerator is not in contact with the walls, surrounding objects or kitchen cabinets and furniture.

- Cans, bottles or dishes inside the refrigerator are not touching and hitting each other.

- All shelves and bins are mounted correctly inside the refrigerator cabinets and doors.

## What, if....



### 1- The appliance will not work, even though it is switched on.

- Check if the power cable is properly connected!
- Check if the mains supply is in order, or if a circuit breaker has been tripped!
- Check the temperature control for correct setting!

### 2- There is a power failure.

Your freezer is suitable for the long-term storage of frozen food that are available commercially and also can be used to freeze and store fresh food.

Do not open the door in case of a power failure.

For a   rated appliance, frozen food in the freezer compartment will not be affected if the power failure lasts shorter than the "Conservation Time From Failure (hours)" mentioned in the rating label.

If the power failure is longer than the "Conservation Time From Failure (hours)", then the food should be checked and either consumed immediately or cooked and then re-frozen.

### 3- Other possible malfunctions

Not every malfunction is a case for our customer service. Very often, you can easily resolve the problem without requesting service. Before requesting service, please check if the malfunction has been caused by an operating error. If this is the case, and a service has been requested, a service charge will be levied even if the appliance is still under guarantee.

If the problem persists please contact your dealer or customer service.

Please have the type and serial number of your appliance ready when calling. The rating label is located inside the appliance.

## Reversing the door

Proceed in numerical order (**Fig. 8**).

Recycling



This product bears the selective sorting symbol for waste electrical and electronic equipment (WEEE).

This means that this product must be handled pursuant to European Directive 2002/96/EC in order to be recycled or dismantled to minimize its impact on the environment. For further information, please contact your local or regional authorities.

Electronic products not included in the selective sorting process are potentially dangerous for the environment and human health due to the presence of hazardous substances.

# Energy

Manufacturer  
Model

More efficient



Less efficient

Energy consumption kWh/year

(Based on standard test results for 24 h)

Actual consumption will depend on how the appliance is used and where it is located

Fresh food volume l  
Frozen food volume l  
Chill compartment volume l

Noise  
(dB(A) re 1 pW)

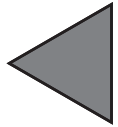

You may stick the energy fiche given in the polybag to the area above.

