



# *MOTOMANUAL*

**MOTOROKR™ E6**  
GSM  
English

[motorola.com](http://motorola.com)



# HELLOMOTO

---

Introducing your new **MOTOROKR™** E6 GSM wireless phone. Here's a quick anatomy lesson.

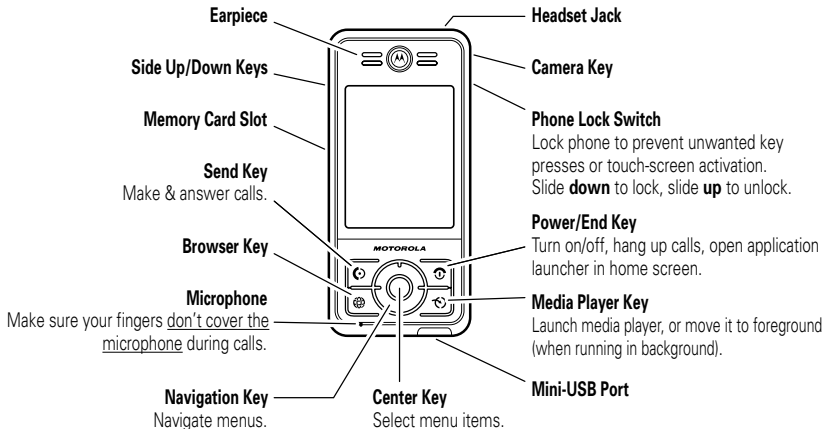

**Note:** The above illustration is for reference only. There may be slight difference between the appearances of handset, keys and contents of display used in this manual and those of your handset. Please refer to your handset for actuality.





### Side Up/Down Keys



Adjust volume, navigate menus.

### Memory Card Slot

Insert SD memory card, store and retrieve multimedia content (music files, video clips, photos).

### Media Player Keys

When the **RealOne media player** is active: Press  to pause or play a file or playlist. Press  or  to play the previous or next file in a playlist. Press and hold  or  to rewind or fast forward.

When the **FM radio** is active: Press  to mute/unmute the radio. Press  or  to select the previous or next channel.

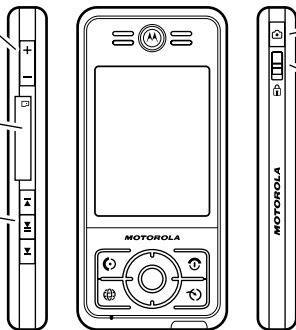

### Mini-USB Port

Insert battery charger or phone accessories.

### Camera Key

Activate camera and take photos.

### Phone Lock Switch

Lock phone to prevent unwanted key presses or touch-screen activation. Slide **down** to lock, slide **up** to unlock.

**Note:** Your phone may not appear as the phone image above, but all key locations, sequences and functions remained the same.

**Note:** The above illustration is for reference only. There may be slight difference between the appearances of handset, keys and contents of display used in this manual and those of your handset. Please refer to your handset for actuality.

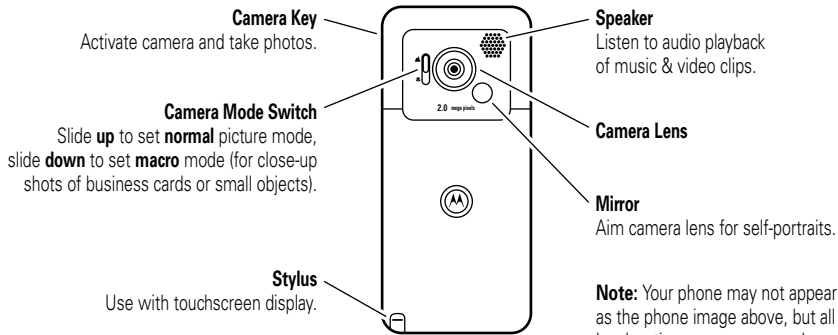

**Note:** The above illustration is for reference only. There may be slight difference between the appearances of handset, keys and contents of display used in this manual and those of your handset. Please refer to your handset for actuality.

Motorola, Inc.  
Consumer Advocacy Office  
1307 East Algonquin Road  
Schaumburg, IL 60196

[www.hellomoto.com](http://www.hellomoto.com)

Certain mobile phone features are dependent on the capabilities and settings of your service provider's network. Additionally, certain features may not be activated by your service provider, and/or the provider's network settings may limit the feature's functionality. Always contact your service provider about feature availability and functionality. All features, functionality, and other product specifications, as well as the information contained in this user's guide are based upon the latest available information and are believed to be accurate at the time of printing. Motorola reserves the right to change or modify any information or specifications without notice or obligation.

MOTOROLA and the Stylized M Logo are registered in the US Patent & Trademark Office. All other product or service names are the property of their respective owners. The Bluetooth trademarks are owned by their proprietor and used by Motorola, Inc. under license. Java and all other Java-based marks are trademarks or registered trademarks of Sun Microsystems, Inc. in the U.S. and other countries. Microsoft, Windows and Windows ME are registered trademarks of Microsoft Corporation; and Windows XP is a trademark of Microsoft Corporation.

© Motorola, Inc., 2006.

**Caution:** Changes or modifications made in the radio phone, not expressly approved by Motorola, will void the user's authority to operate the equipment.

### **Software Copyright Notice**

The Motorola products described in this manual may include copyrighted Motorola and third-party software stored in semiconductor memories or other media. Laws in the United States and other countries preserve for Motorola and third-party software providers certain exclusive rights for copyrighted software, such as the exclusive rights to distribute or reproduce the copyrighted software. Accordingly, any copyrighted software contained in the Motorola products may not be modified, reverse-engineered, distributed, or reproduced in any manner to the extent allowed by law. Furthermore, the purchase of the Motorola products shall not be deemed to grant either directly or by implication, estoppel, or otherwise, any license under the copyrights, patents, or patent applications of Motorola or any third-party software provider, except for the normal, non-exclusive, royalty-free license to use that arises by operation of law in the sale of a product.

# contents

---

<b>Safety Information</b> . . . . .	8	application launcher . . . . .	26	color scheme . . . . .	39
<b>Use and Care</b> . . . . .	13	button bar . . . . .	28	backlight . . . . .	40
<b>EU Conformance</b> . . . . .	14	status bar . . . . .	28	<b>calls</b> . . . . .	<b>41</b>
<b>Recycling Information</b> . . . . .	15	text entry . . . . .	29	recent calls . . . . .	41
<b>essentials</b> . . . . .	<b>16</b>	tap & hold . . . . .	32	redial . . . . .	42
about this guide . . . . .	16	volume . . . . .	32	hold or mute a call . . . . .	43
SIM card . . . . .	16	navigation key . . . . .	33	call waiting . . . . .	43
battery . . . . .	18	speakerphone . . . . .	33	caller ID . . . . .	43
memory card . . . . .	21	codes & passwords . . . . .	34	cancel incoming call . . . . .	44
turn it on & off . . . . .	22	lock & unlock phone . . . . .	34	emergency calls . . . . .	44
make a call . . . . .	23	lock touch-screen &		international calls . . . . .	45
answer a call . . . . .	23	phone keys . . . . .	35	turbo dial . . . . .	45
your phone number . . . . .	24	share information . . . . .	36	dial extension or	
<b>basics</b> . . . . .	<b>25</b>	<b>customize</b> . . . . .	<b>38</b>	voicemail number . . . . .	46
display . . . . .	25	profiles . . . . .	38	dial extension number	
global navigation bar . . . . .	26	wallpaper . . . . .	39	during a call . . . . .	46

<b>address book . . . . .</b>	<b>47</b>	unsent messages . . . . .	63	tasks . . . . .	87
view contact list . . . . .	47	tips for sending		notes . . . . .	88
add new contact . . . . .	48	messages . . . . .	64	viewer . . . . .	88
create group . . . . .	49	receive message . . . . .	64	calculator . . . . .	89
call or send message . . . . .	49	read and reply . . . . .	66	alarm clock . . . . .	90
search . . . . .	50	store message object . . . . .	66	file manager . . . . .	91
sort . . . . .	51	sort messages . . . . .	66	business card reader . . . . .	95
delete contact . . . . .	51	drafts . . . . .	67	<b>media applications . . . . .</b>	<b>98</b>
storage location . . . . .	51	deleted messages . . . . .	67	browser . . . . .	98
copy contacts . . . . .	52	messages on		RealOne media player . . . . .	103
categories . . . . .	52	SIM card . . . . .	67	camera . . . . .	105
check capacity . . . . .	54	create folder . . . . .	67	voice recorder . . . . .	110
share contact . . . . .	55	move messages . . . . .	68	video camera . . . . .	111
synchronize contacts . . . . .	55	set up message		photo editor . . . . .	111
owner's information . . . . .	56	service . . . . .	69	FM radio . . . . .	113
<b>messages . . . . .</b>	<b>57</b>	browser messages . . . . .	72	<b>extra applications . . . . .</b>	<b>116</b>
message center . . . . .	57	information service		talking phone . . . . .	116
signature . . . . .	58	messages . . . . .	73	Bluetooth™ wireless . . . . .	116
send text message . . . . .	59	<b>office applications . . . . .</b>	<b>75</b>	synchronize phone	
send multimedia		email . . . . .	75	information . . . . .	120
message . . . . .	60	calendar . . . . .	82	modem . . . . .	121



STK . . . . .	122
world time . . . . .	123
<b>other features . . . . .</b>	<b>124</b>
advanced calling . . . . .	124
setup . . . . .	125
call times & costs . . . . .	128
handsfree . . . . .	129
security . . . . .	130
<b>SAR Data . . . . .</b>	<b>132</b>
<b>WHO Information . . . . .</b>	<b>133</b>
<b>GNU License . . . . .</b>	<b>134</b>
<b>index . . . . .</b>	<b>135</b>

# Safety and General Information

---

**This section contains important information on the safe and efficient operation of your mobile device. Read this information before using your mobile device.\***

## Exposure to Radio Frequency (RF) Energy

Your mobile device contains a transmitter and receiver. When it is ON, it receives and transmits RF energy. When you communicate with your mobile device, the system handling your call controls the power level at which your mobile device transmits.

Your Motorola mobile device is designed to comply with local regulatory requirements in your country concerning exposure of human beings to RF energy.

## Operational Precautions

For optimal mobile device performance and to be sure that human exposure to RF energy does not exceed the guidelines set forth in the relevant standards, always follow these instructions and precautions.

### External Antenna Care

If your mobile device has an external antenna, use only a Motorola-supplied or approved replacement antenna. Use of unauthorized antennas, modifications, or attachments could damage the mobile device and/or may result in your device not complying with local regulatory requirements in your country.

DO NOT hold the external antenna when the mobile device is IN USE. Holding the external antenna affects call quality and may cause the mobile device to operate at a higher power level than needed.

---

\* The information provided in this document supersedes the general safety information in user's guides published prior to May 1, 2006.

## Product Operation

When placing or receiving a phone call, hold your mobile device just like you would a landline phone.

If you wear the mobile device on your body, always place the mobile device in a Motorola-supplied or approved clip, holder, holster, case, or body harness. If you do not use a body-worn accessory supplied or approved by Motorola, keep the mobile device and its antenna at least 2.5 centimeters (1 inch) from your body when transmitting.

When using any data feature of the mobile device, with or without an accessory cable, position the mobile device and its antenna at least 2.5 centimeters (1 inch) from your body.

Using accessories not supplied or approved by Motorola may cause your mobile device to exceed RF energy exposure guidelines. For a list of Motorola-supplied or approved accessories, visit our Web site at: [www.motorola.com](http://www.motorola.com).

## RF Energy Interference/Compatibility

Nearly every electronic device is subject to RF energy interference from external sources if inadequately shielded, designed, or otherwise configured for RF energy compatibility. In some circumstances your mobile device may cause interference with other devices.

## Follow Instructions to Avoid Interference Problems

Turn off your mobile device in any location where posted notices instruct you to do so. These locations include hospitals or health care facilities that may be using equipment that is sensitive to external RF energy.

In an aircraft, turn off your mobile device whenever instructed to do so by airline staff. If your mobile device offers an airplane mode or similar feature, consult airline staff about using it in flight.

## Pacemakers

If you have a pacemaker, consult your physician before using this device.

Persons with pacemakers should observe the following precautions:

- ALWAYS keep the mobile device more than 20 centimeters (8 inches) from your pacemaker when the mobile device is turned ON.
- DO NOT carry the mobile device in the breast pocket.
- Use the ear opposite the pacemaker to minimize the potential for interference.
- Turn OFF the mobile device immediately if you have any reason to suspect that interference is taking place.

## Hearing Aids

Some mobile devices may interfere with some hearing aids. In the event of such interference, you may want to consult your hearing aid manufacturer or physician to discuss alternatives.

## Other Medical Devices

If you use any other personal medical device, consult your physician or the manufacturer of your device to determine if it is adequately shielded from RF energy.

## Driving Precautions

Check the laws and regulations on the use of mobile devices in the area where you drive. Always obey them.

When using your mobile device while driving, please:

- Give full attention to driving and to the road. Using a mobile device may be distracting. Discontinue a call if you can't concentrate on driving.
- Use handsfree operation, if available.
- Pull off the road and park before making or answering a call if driving conditions so require.

Responsible driving practices can be found in the "Smart Practices While Driving" section at the end of this guide and/or at the Motorola Web site: [www.motorola.com/callsmart](http://www.motorola.com/callsmart).

## Operational Warnings

Obey all posted signs when using mobile devices in public areas, such as health care facilities or blasting areas.

## Automobile Air Bags

Do not place a mobile device in the air bag deployment area.

## Potentially Explosive Atmospheres

Areas with potentially explosive atmospheres are often but not always posted, and can include fueling areas such as below decks on boats, fuel or chemical transfer or storage facilities, or areas where the air contains chemicals or particles, such as grain, dust, or metal powders.

When you are in such an area, turn off your mobile device, and do not remove, install, or charge batteries. In such areas, sparks can occur and cause an explosion or fire.

## Damaged Products

If your mobile device or battery has been submerged in water, punctured, or subjected to a severe fall, do not use it until you take it to a Motorola Authorized Service Center. Do not attempt to dry it with an external heat source, such as a microwave oven.

## Batteries and Chargers

If jewelry, keys, beaded chains, or other conductive materials touch exposed battery terminals, this could complete an electrical circuit (short circuit), become very hot, and could cause damage or injury. Be careful when handling a charged battery, particularly when placing it inside a pocket, purse, or other container with metal objects. **Use only Motorola Original batteries and chargers.**



**Caution:** To avoid risk of personal injury, do not dispose of your battery in a fire.

Your battery, charger, or mobile device may contain symbols, defined as follows:

Symbol	Definition
	Important safety information follows.
	Do not dispose of your battery or mobile device in a fire.
	Your battery or mobile device may require recycling in accordance with local laws. Contact your local regulatory authorities for more information.

Symbol	Definition
	Do not throw your battery or mobile device in the trash.
	Your mobile device contains an internal lithium ion battery.
	Do not let your battery, charger, or mobile device get wet.
	Listening at full volume to music or voice through a headset may damage your hearing.

## Choking Hazards

Your mobile device or its accessories may include detachable parts, which may present a choking hazard to small children. Keep your mobile device and its accessories away from small children.

## Glass Parts

Some parts of your mobile device may be made of glass. This glass could break if the product is dropped on a hard surface or receives a substantial impact. If glass breaks, do not touch or attempt to remove. Stop using your mobile device until the glass is replaced by a qualified service center.

## Seizures/Blackouts

Some people may be susceptible to epileptic seizures or blackouts when exposed to flashing lights, such as when playing video games. These may occur even if a person has never had a previous seizure or blackout.

If you have experienced seizures or blackouts, or if you have a family history of such occurrences, please consult with your physician before playing video games or enabling a flashing-lights feature (if available) on your mobile device.

Discontinue use and consult a physician if any of the following symptoms occur: convulsion, eye or muscle twitching, loss of awareness, involuntary movements, or disorientation. It is always a good idea to hold the screen away from your eyes, leave the lights on in the room, take a 15-minute break every hour, and stop use if you are very tired.

## Caution About High Volume Usage



Listening at full volume to music or voice through a headset may damage your hearing.

## Repetitive Motion

When you repetitively perform actions such as pressing keys or entering finger-written characters, you may experience occasional discomfort in your hands, arms, shoulders, neck, or other parts of your body. If you continue to have discomfort during or after such use, stop use and see a physician.

# Use and Care

---

To care for your Motorola phone, please keep it away from:



## liquids of any kind

Don't expose your phone to water, rain, extreme humidity, sweat, or other moisture.



## dust and dirt

Don't expose your phone to dust, dirt, sand, food, or other inappropriate materials.



## extreme heat or cold

Avoid temperatures below -10°C/14°F or above 45°C/113°F.



## cleaning solutions

To clean your phone, use only a dry soft cloth. Don't use alcohol or other cleaning solutions.



## microwaves

Don't try to dry your phone in a microwave oven.



## the ground

Don't drop your phone.

# European Union Directives Conformance Statement

---



Hereby, Motorola declares that this product is in compliance with

- The essential requirements and other relevant provisions of Directive 1999/5/EC
- All other relevant EU Directives

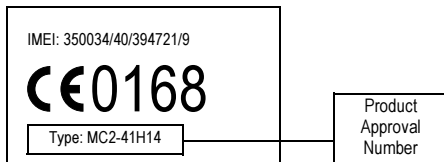

The above gives an example of a typical Product Approval Number.

You can view your product's Declaration of Conformity (DoC) to Directive 1999/5/EC (to R&TTE Directive) at [www.motorola.com/rtte](http://www.motorola.com/rtte). To find your DoC, enter the product Approval Number from your product's label in the "Search" bar on the web site.



# Caring for the Environment by Recycling

---



This symbol on a Motorola product means the product should not be disposed of with household waste.

## Disposal of your Mobile Telephone and Accessories

---

Please do not dispose of mobile telephones or electrical accessories, such as chargers or headsets, with your household waste. In some countries or regions, collection systems have been set up to handle waste electrical and electronic items. Please contact your regional authorities for more details. If no suitable scheme exists, you may return unwanted mobile telephones and electrical accessories to any Motorola Approved Service Centre in your region.

# essentials

---

## about this guide

This guide describes the basic features of your Motorola wireless phone.

### symbols



This means a feature is network, SIM card, or subscription dependent and may not be available in all areas. Contact your service provider for more information.



This means a feature requires an optional accessory.

## SIM card

Your *Subscriber Identity Module* (SIM) card contains personal information like your phone number and contacts list.

**Caution:** Don't bend or scratch your SIM card. Keep it away from static electricity, water, and dirt.

- 1 Pull the stylus halfway out of the phone.

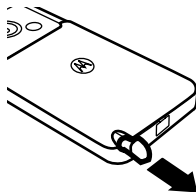

- 2 Press down the release latch, then slide the battery door away from the camera lens and remove it from the phone.

**Caution:** The battery door on your phone has sharp corner edges around the stylus. Be careful when removing or attaching the battery door.

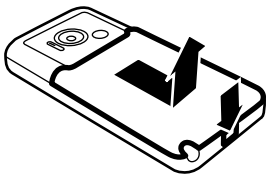

- 3 Gently slide the SIM card latch down.

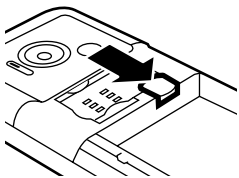

- 4 Hold the SIM card with the gold plate facing down. Slide the SIM card under the metal tabs and into the card slot.

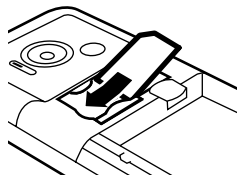

- 5 Slide the SIM card latch up to lock the SIM card in place.

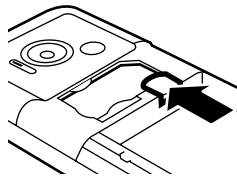

# battery

## battery installation

- 1 Pull the stylus halfway out of the phone.

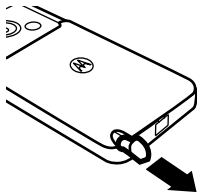

- 2 Press down the release latch, then slide the battery door away from the camera lens and remove it from the phone.

**Caution:** The battery door on your phone has sharp corner edges around the stylus. Be careful when removing or attaching the battery door.

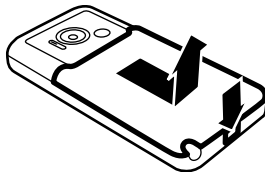

- 3 Insert the battery under the tabs on the left side of the battery compartment and push down.

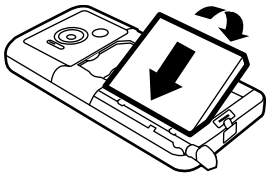

- 4 Pull the stylus halfway out of the phone, then place the battery door on the phone and slide it up to lock shut.

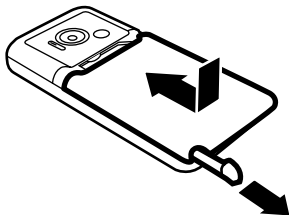

## battery charging

New batteries are not fully charged. Insert the battery charger plug into the mini-USB port

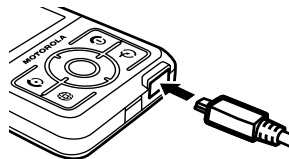

at the base of your phone as shown, and plug the other end into an electrical outlet.

Your phone might take several seconds to start charging the battery, and might require several hours to charge fully. The display shows **Charge Complete** when finished.

**Tip:** Relax, you can't overcharge your battery. It will perform best after you fully charge and discharge it a few times.

**Note:** You can charge the battery when the phone is off or the battery is completely discharged.

**Note:** You can charge your battery by connecting a cable from your phone's mini-USB port to a USB port on a computer. Both your phone and the computer must be turned on, and your computer must have the correct software drivers installed. Cables and software drivers are available in Motorola Original data kits, sold separately.



## battery tips

Battery life depends on the network, signal strength, temperature, features, and accessories you use.

- Always use Motorola Original batteries and chargers. The warranty does not cover damage caused by non-Motorola batteries and/or chargers.



- New batteries or batteries stored for a long time may take more time to charge.
- When charging your battery, keep it near room temperature.
- When storing your battery, keep it uncharged in a cool, dark, dry place.
- Never expose batteries to temperatures below -10°C (14°F) or above 45°C (113°F). Always take your phone with you when you leave your vehicle.
- It is normal for batteries to gradually wear down and require longer charging times. If you notice a change in your battery life, it is probably time to purchase a new battery.



Contact your local recycling center for proper battery disposal.

**Warning:** Never dispose of batteries in a fire because they may explode.

Before using your phone, read the battery safety information in the “Safety and General Information” section included in this guide.

## memory card

You can use an optional removable SD memory card or MMC memory card with your phone to store and retrieve multimedia content (such as music files, video clips, and photos).



**Caution:** Don't bend or scratch your memory card. Keep it away from static electricity, water, and dirt.

Open the protective cover on your phone's memory card slot, then insert the memory card into the memory card slot on the side of your phone until it clicks into place.

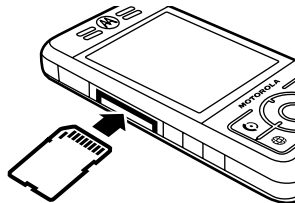

### To remove the memory card:

- 1 Tap the status bar at the top of the display to open the device status screen.
- 2 Tap the scroll bar to scroll down to the **Memory Card** option, then tap the **Eject** button.
- 3 Wait for your phone to indicate that it's safe to remove the memory card, then tap **OK**.

- 4 Push the card in until it clicks, the spring mechanism will eject the card for removal.

## turn it on & off

**Caution:** On power up, the phone may prompt you to enter your SIM card PIN code to unlock the SIM card. If you enter an incorrect PIN code three times before the correct code, your SIM card is disabled and your display shows **SIM Blocked**. Contact your service provider.

To turn on your phone, press and hold the *power key*  until the display lights up. If prompted, enter your eight-digit SIM card PIN code and/or four-digit unlock code.

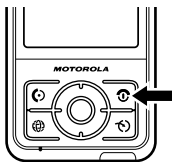



If you don't insert a SIM card, your phone shows **No SIM Card**. You can select **Antenna On** (to make an emergency call) or **Antenna Off** (to use the phone's non-calling features).

You can turn off the phone's **antenna** in locations where wireless phone use is prohibited, or when you just want to use the phone's non-calling features (games, personal organizer, multimedia player). Tap the status bar at the top of the display to open the device status screen, then tap the **Antenna** drop-down menu to select **On** or **Off**.

To turn off your phone, press and hold  for two seconds.





## make a call

- 1 Tap  in the top global navigation bar to open the phone keypad.
- 2 Tap the keypad keys to dial the phone number.
- 3 Tap **Call** or press the *send key*  to make the call.
- 4 When you are finished, tap **End** or press the *end key*  to end the call.

**Tip:** Tap  to select a number from a list of recent received or dialed calls.





**Tip:** If you need to use the phone keypad during a call (for example, to dial an extension or make a conference call), tap the keypad button  from the in-call screen. Tap the phone button  to return to the in-call screen.

## answer a call

When you receive a call, your phone rings and/or vibrates and shows an incoming call message.

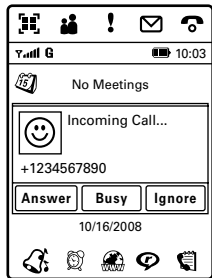
**Tip:** You can press the volume keys to mute the ringer before answering the call.





Tap **Answer** or press the *send key*  to answer the call.

When you are finished, tap **End** or press the *end key*  to end the call.

**Tip:** If you prefer not to answer the call, you can tap **Ignore** to hang up on the caller, or tap **Busy** to transmit a busy tone signal to the caller (tapping **Busy** may divert the incoming call to your voicemail inbox).

## your phone number



To **view** your phone number:

- 1 Tap  in the top global navigation bar to open the phone keypad.
- 2 Tap  in the bottom button bar to open the phone menu.
- 3 Tap **My Number** to see your phone number.

To see your phone number while you're on a call, tap  and then tap **My Number**.

To **store** or edit your name and phone number on your SIM card:



- 1 Tap  in the top global navigation bar to open the phone keypad.
- 2 Tap , then tap **Setup** to open the phone setup menu.
- 3 Tap **My Number** to open the number editor.
- 4 Enter your name and number (for line 1 **and** line 2, if applicable), then tap **Done** to store the information.

If you don't know your phone number, contact your service provider.

# basics

---

See pages 1-3 for basic phone diagrams.

## display

The *home screen* appears when you turn on your phone.

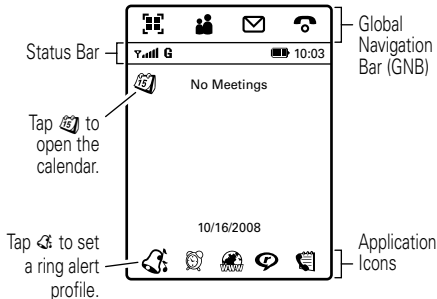

The home screen shows the next scheduled calendar event for the day. Icons at the bottom of the screen provide shortcuts to commonly used applications.





To use your phone's features, tap on the global navigation bar icons, application icons, buttons, and text with the provided stylus.



To change the options that you see in the home screen, tap to open the application launcher, tap **Setup**, then tap **Home Screen Setup**.

**Tip:** Tap an unused area of the home screen to see an unobstructed fullscreen view of the background *wallpaper* image. Tap the fullscreen wallpaper image to return to the home screen display.

# global navigation bar

Icons in the top *global navigation bar* give you easy access to your phone's primary functions:

-  **Application Launcher**
-  **Address Book**
-  **Messages**
-  **Phone**

Your phone also shows a new message icon  in the global navigation bar to notify you of a new message or a missed call. Tap  to see information about the message or missed call.

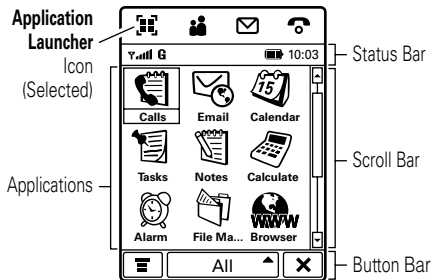

# application launcher

Tap the application launcher icon  in the global navigation bar to open the application launcher.













Tap the button in the bottom center of the screen to see **All** application icons, or to see application icons in predefined categories.

If necessary, tap the scroll bar on the right side of the screen to see additional icons. Tap an icon to select it.

**Tip:** To show applications in an text-based list, tap , then tap **List View**. From list view, tap , then tap **Thumbnail View** to reset the graphic icons.

You can select the following icons on the application launcher screens:

## office applications

	<b>Recent Calls</b>		<b>Email</b>
	<b>Calendar</b>		<b>Tasks</b>
	<b>Notes</b>		<b>Calculator</b>
	<b>Alarm Clock</b>		<b>File Manager</b>
	<b>Viewer</b>		<b>Business Card Reader</b>

## multimedia applications

	<b>Browser</b>		<b>Camera</b>
	<b>Recorder</b>		<b>Video Camera</b>
	<b>Photo Editor</b>		<b>Media Player</b>
	<b>FM Radio</b>		

## extra applications



	<b>Setup</b>		<b>Modem</b>
	<b>Bluetooth</b>		<b>Sync</b>
	<b>STK</b>		<b>World Time</b>

## games

Your phone may contain Java™ games or applications that add features and functionality to your phone. Instructions are included with each game. You select Java games from the application launcher screen.

## button bar

The button bar shows functions you can select in the active application. Standard buttons include:

-  **Menu** Tap to open context sensitive menu.
-  **Return** Tap to return to previous screen.
-  **Exit** Tap to exit current application.

## status bar

**Tip:** Tap the status bar to see additional phone status information.

The following indicators can appear in the status bar:

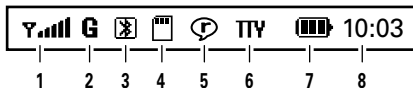

- 1 signal strength** – Vertical bars show the strength of the network connection. You can't make or receive calls when the no signal indicator **Y** or no transmission indicator **YX** shows.
- 2 GPRS** – Shows when your phone is using a high-speed *General Packet Radio Service* (GPRS) network connection. 

- Bluetooth** – Shows that Bluetooth™ power is turned on. When Bluetooth power is on, your phone can make a wireless connection with a headset accessory or other external device.
- memory card** – Shows when a memory card is inserted in your phone.
- RealOne** – Shows when the RealOne media player is playing media content.
- TTY** – Shows when your phone is set up for use with an optional TTY device. 
- battery level** – Vertical bars show the battery charge level. Recharge the battery when your phone shows **Low Battery**.
- clock** – Shows the current time.

## text entry

Multiple text entry methods make it easy for you to enter names, numbers, and messages. The method you select remains active until you change it.

Tap a text entry area on the screen to open a text entry window. If necessary, tap the entry method drop-down menu at the bottom of the screen to select a text entry method.

Tap  in the lower right corner of the screen to hide the text entry keyboard or pad when you're finished, or when you want to use the button bar functions.

## handwriting

You can use the stylus as a pen to write letters, numbers, and punctuation directly on the screen.

In a text entry window, tap the entry method drop-down menu and tap **Handwriting** to open the handwriting pad. Tap a button on the handwriting pad to select Chinese characters, English text, or numbers.



Use the stylus to write in either of the two writing spaces. For best performance, alternate between writing spaces so that the character in one space can be recognized while you write in the other. You can write a symbol (instead of text) in the symbol box in the lower right corner of the writing area.

Write a character, then wait for your phone to recognize and place it in the text entry window. If the phone places an incorrect character, tap the character in the choice area that you want to replace it.

Your phone can predict the word you are writing. Tap a word in the prediction area to place it in the text entry window. To activate predictive text entry, see page 32.

To enter special characters or edit text, use the function buttons described on page 31.

## Pinyin keyboard

In a text entry window, tap the entry method drop-down menu and tap **Pinyin Board** to enter Chinese characters with the Pinyin keyboard.



Tap keyboard characters to spell the pinyin. Your letters appear in the pinyin area, and corresponding Chinese characters appear in the choice area. To see additional characters, tap the previous button ◀ or next button ▶.



Tap the desired character to place it at the cursor location in the entry window.

Your phone predicts the pinyin you are spelling, and highlights the next letters you can type to finish the word.

## Zhuyin keyboard

In a text entry window, tap the entry method drop-down menu and tap **Zhuyin Board** to enter words using Zhuyin characters.



## English keyboard

In a text entry window, tap the entry method drop-down menu and tap **English Keyboard** to enter letters and numbers at the cursor location.





## numeric pad

In a text entry window, tap the entry method drop-down menu and tap **Numeric Pad** to enter digits or numeric symbols at the cursor location.



## function buttons

Tap [%#+] with any text entry method to open the symbol pad, to enter a symbol at the cursor location. Tap [🔒] to lock or unlock the symbol pad. Tap other buttons to perform the following functions:

-  Delete character to left of cursor.
-  Move cursor to next line.
-  Enter space at cursor location.

**Tip:** Tap a location in the text entry window to move the cursor to that location.

## adjust text input settings

You can set your preferred input method, primary and secondary language preferences, specify your writing hand (left or right) and handwriting speed, activate word prediction and word completion, activate a user dictionary, and apply a watermark to the text you enter.

Tap  **Setup** in the application launcher screen, then tap **Input Setup** to open the input setting screen. Adjust settings, then tap **Save** to save your settings and return to the setup screen.

## tap & hold

When using phone applications, in many cases you can tap and hold on an icon, file, or field to open a pop-up menu to perform various operations on the selected item. If the specific task you want to perform in an application is not already listed in the display, try using tap and hold to see if the feature you want is available in a pop-up menu.

## volume

Press the side up/down keys to:

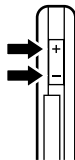

- turn off a *call alert* (the ringer that announces an incoming call)



- change the earpiece or speakerphone volume during a call
- change the speaker volume when playing a song or video clip, or when listening to the FM radio

Tap  in the home screen to set the ring alert profile. For more information, see page 38.

## navigation key

Press the *navigation* key  up, down, left, or right to scroll and highlight menu items. When you highlight something, press the *center key*  to select it.

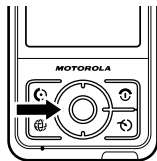

This guide describes how to use the stylus and touch-screen to use your phone's features. In most cases, it doesn't include the equivalent navigation key control for using the feature.

## speakerphone

When you activate your phone's handsfree speakerphone, you can talk to the other party without holding the phone to your ear.

During a call, tap **Spkr** to turn the handsfree speakerphone on or off. The handsfree speakerphone remains on until you tap **Spkr** again or turn the phone off.

The handsfree speakerphone is disabled when you connect your phone to a handsfree car kit or headset accessory.

## codes & passwords

Your phone's four-digit **unlock code** is originally set to **1234**. The six-digit **security code** is originally set to **000000**. If your service provider didn't change these codes, you should change them.

You can also change your **SIM PIN** or call barring passwords.

To change a code or password, tap  **Setup** in the application launcher screen, tap **Security**, then tap **Change Passwords** to open the change passwords screen.

**If you forget your unlock code:** At the **Enter Unlock Code** prompt, try entering 1234 or the last four digits of your phone number. If that doesn't work, tap  to open the unlock code bypass screen. Enter your security code, then tap **OK** to submit the security code.

**If you forget other codes:** If you forget your security code, SIM PIN code, PIN2 code, or call barring password, contact your service provider.

## lock & unlock phone

You can lock your phone to keep others from using it. To lock or unlock your phone, you need the four-digit unlock code.

To **automatically lock** your phone after a specified period of inactivity: Tap  **Setup** in the application launcher screen, tap **Security**, then select a **Phone Lock** timer setting. Your phone prompts you to enter the unlock code. Enter your unlock code to activate phone lock.

To automatically lock your phone whenever you turn it on: Tap  **Setup** in the application launcher screen, tap **Security**, then set **Phone Lock** to **Power On**.

To **unlock** your phone: When you see the **Enter Unlock Code** prompt, enter your unlock code to unlock the phone.

**Tip:** Your phone's unlock code is originally set to 1234. Many service providers reset the unlock code to the last four digits of your phone number.

**Note:** You can make emergency calls on a locked phone (for more information, see page 44). You also can receive and answer incoming calls when the phone is locked.

## lock touch-screen & phone keys

You can lock the touch-screen and phone keys to prevent accidental key presses (for example, when carrying your phone in a purse or pocket).

Slide the phone lock switch **down** (see illustration on page 2) to lock the touch-screen and keys. Slide the phone lock switch **up** to unlock the touch-screen and keys.

# share information

You can share information with another phone, PC, or hand-held device. You can share address book contacts, calendar events, tasks, note pad entries, voice records, pictures, photos, and sound files by sending or receiving the data through a Bluetooth wireless connection, or in an MMS or email message.

**Tip:** In some cases, the share option is only available from the tap and hold pop-up menu.

## send data

**1** Locate the data you want to share (such as contact details, or a list of files in the file manager), tap , then tap **Share** to select one or more items to share.

**or**

Tap and hold an item to open a pop-up menu, then tap **Share** to see a list of share options.

**2** Tap **Bluetooth**, then tap **OK** to exchange the data through a Bluetooth wireless connection.

**or**

Tap **MMS** or **Email**, then tap **OK** to send the data in an MMS or email message.

**3** Complete the setup procedure for the transfer method you selected.

**4** Tap **OK** to send the data.

For more information about using a Bluetooth wireless connection, see page 116.

## receive data

The sending device must establish a transmission link with your phone through a Bluetooth, MMS, or email connection.

If necessary, turn on Bluetooth power on your phone to let the other device establish a wireless link (to turn Bluetooth power on, see page 117).

Your phone alerts you when it receives a data transfer request from the other device. If necessary, tap **OK** to accept the data.

Your phone notifies you when data transfer is complete. If the transfer is not successful, your phone shows the message **Failed to Receive**.

# customize

---

## profiles

You can quickly change your phone's ring alert profile to match your activity, environment, or personal requirements. Each profile uses a different set of ringtones or vibrations for incoming calls and other events. The **Silent** profile silences your phone until you set another profile. Here are the profiles you can choose:

 **Ring Loud**

 **Vibe then Ring Loud**

 **Vibe then Ring Soft**

 **Vibrate**

 **Vibe and Ring Loud**

 **Ring Soft**

 **Silent**

The current profile icon shows in the lower-left corner of the home screen.

## set the ring alert profile

Tap  in the home screen to set the ring alert profile.

## change profile settings

You can change the ringtones that a profile uses to notify you of incoming calls and other events.

**Note:** You can't set a ringtone for the **Silent** profile, or change some settings for some profiles.



- 1 Tap **✕ Setup** in the application launcher screen, then tap **Ringer Alert Style**.
- 2 Tap a profile, then tap **Edit** to adjust ringtone settings to personalize the profile. You can change the ringtones used to notify you of incoming calls and messages, set ringer IDs, and adjust alert volume, touch-screen volume, and keypad volume. Any changes you make are saved to the profile.

## wallpaper

Set a photo or picture as a wallpaper (background) image in your phone's display. The wallpaper image appears as a faint watermark in text and menu displays.

- 1 Tap **✕ Setup** in the application launcher screen, then tap **Wallpaper**.

- 2 Tap a photo/picture thumbnail image to set it as the wallpaper image. Tap the fullscreen image preview to return to the wallpaper menu.
- 3 Tap **OK** to save your setting.

**Tip:** Tap an unused area of the homescreen to see an unobstructed fullscreen view of the wallpaper image. Tap the fullscreen wallpaper image to return to the home screen.



## color scheme



Set the colors that your phone uses for buttons, highlights, and the status bar.

**Note:** This feature changes the look and feel of the phone's user interface, including the icons that you see in the top global navigation bar.

- 1 Tap  **Setup** in the application launcher screen, then tap **Color Scheme**.
- 2 Tap a thumbnail image to select it as the color scheme. Your phone shows a brief preview of the selected color scheme.
- 3 Tap **OK** to save your setting.

## backlight

- 1 Tap  **Setup** in the application launcher screen, then tap **Backlight Setup**.
- 2 Tap  and  to decrease or increase backlight brightness.
- 3 Tap **Backlight Sleep Time** to set the amount of time that the backlight remains on.
- 4 Tap **Save** to save your settings.

**Tip:** Press and hold the send key  in any screen to maximize backlight brightness. Press and hold  again to return to the default brightness setting.

**Note:** Your phone's display normally is visible only when the display backlight is on, or when the display is viewed in direct sunlight. To extend battery life, the backlight turns off automatically when no activity is detected for a period of time. The backlight turns back on when you tap the screen or press any key.



# calls

---



To make and answer calls, see page 23.

## recent calls

Your phone keeps lists of incoming and outgoing calls, even for calls that didn't connect. The most recent calls are listed first. The oldest calls are deleted as new calls are added.

**Shortcut:** Press the send key  to open the recent calls list. Press the navigation key  to scroll and select a call list, scroll to a number, press  to call it.



To **dial** a number in the recent calls list:

- 1 Tap  in the global navigation bar to open the phone keypad.
- 2 Tap  to open the recent calls menu.
- 3 Tap **Answered Calls**, **Missed Calls**, or **Dialed Calls** to select a call list.
- 4 Tap an entry to call its number.



To **see** details or perform other operations on an entry in the recent calls list:

- 1 Tap  **Recent Calls** in the application launcher screen to open the call history screen.
- 2 Tap **Answered Calls**, **Missed Calls**, or **Dialed Calls** to select a call list.

- 3 Tap an entry to see call details (time, date, duration).
- 4 Tap **Call** to call its number, or tap  to perform the following operations:

options	
<b>Store</b>	Create an address book entry with the number stored in the number type field you specify.
<b>Send SMS</b>	Open a new text message with the number in the <b>To</b> field. 
<b>Send MMS</b>	Open a new multimedia message with the number in the <b>To</b> field. 
<b>Delete</b>	Delete the entry.



## redial

- 1 Tap  in the global navigation bar to open the phone keypad.
- 2 Tap , then tap **Dialed Calls** to open the dialed calls list.
- 3 Tap the number you want to redial.

If you hear a **busy signal** and you see **Call Failed, Number Busy**, tap **Redial** to automatically redial the number.



To **activate** the automatic redial feature:

- 1 Tap  in the global navigation bar to open the phone keypad.
- 2 Tap , then tap **Setup** to open the phone setup menu.

- 3 Tap the check box  beside **Auto Redial**. A check mark  indicates that automatic redial is activated.
- 4 Tap  to exit the phone setup menu.

## hold or mute a call

To put all active calls on hold, tap **Hold**. Tap **Hold** again to resume the call.

To turn off your phone's microphone during a call, tap **Mute**. Tap **Mute** again to resume the call.

## call waiting



When you're on a call, you'll hear an alert if you receive a second call.

Tap **Answer** to put the first call on hold and answer the new call.

To switch between calls, tap **Switch**.

To connect the two calls, tap **Link**.

## caller ID



*Calling line identification* (caller ID) shows the phone number for an incoming call in your phone's display.

Your phone shows the caller's name and picture when they're stored in your address book, or **Incoming Call** when caller ID information isn't available.

You can set your phone to play a unique ringtone for an entry stored in your address book (for more information, see page 48).

To show or hide **your phone number** for the calls that you make:

- 1 Tap  in the global navigation bar to open the phone keypad.
- 2 Tap , then tap **Setup** to open the phone setup menu.

3 Tap **Show ID**, then tap **On** or **Off** to show or hide your caller ID for outgoing calls.

4 Tap  to exit the phone setup menu.

**Tip:** Select **Network Controlled** to let the network determine your caller ID status.

## cancel incoming call

While the phone is ringing or vibrating, tap **Ignore** to cancel the incoming call.

Depending on your phone settings and/or service subscription, the call may be forwarded to another number, or the caller may hear a busy signal.

## emergency calls

Your service provider programs one or more emergency phone numbers, such as 911 or 112, that you can call under any circumstances, even when your phone is locked or the SIM card is not inserted.

**Note:** Emergency numbers vary by country. Your phone's preprogrammed emergency number(s) may not work in all locations, and sometimes an emergency call cannot be placed due to network, environmental, or interference issues.

- 1 Tap  in the global navigation bar to open the phone keypad.
- 2 Tap the keypad keys to dial the emergency number.
- 3 Tap **Send** to make the call.

## international calls



Open the phone keypad, tap , tap **Insert**, then select **Insert +** to insert your local international access code (indicated by +). Then, tap the keypad keys to dial the country code and phone number.

**Shortcut:** Tap and hold the **0** key on the phone keypad to insert your international access code.

## turbo dial



You can store nine phone numbers in the turbo dial list, then dial the numbers by tapping and holding a single keypad number key.

To **turbo dial** a phone number:

- 1 Tap  in the global navigation bar to open the phone keypad.
- 2 Tap and hold a keypad key to dial the phone number assigned to the key.

If no number is stored, your phone prompts you to store a phone number in the turbo dial numbers list.

To **set up** the turbo dial numbers list:

- 1 Tap  in the global navigation bar to open the phone keypad.
- 2 Tap , then tap **Setup** to open the phone setup menu.
- 3 Tap **Turbo Dialing** to open the turbo dial list.
- 4 Enter phone numbers in the turbo dial list.

## dial extension or voicemail number





To **direct dial** an extension number or voicemail number, you can insert a pause character (**P**) in the dialing sequence.

- 1 Use the keypad key to dial the phone number.
- 2 When you need to insert a pause, tap , tap **Insert**, then select **Insert Pause** to insert a **P** at the cursor location.
- 3 Dial the extension number.
- 4 Tap **Call** to make the call.

Your phone dials the phone number, waits for the call to connect, then dials the remaining digits.

**Tip:** Use the same procedure to insert a wait character (**W**) in the dialing sequence. Your phone dials the number, waits for the call to connect, then prompts you for confirmation before it dials the remaining digits.

## dial extension number during a call

- 1 Tap the keypad button  to open the phone keypad.
- 2 Dial the extension number.
- 3 Tap  to return to the in-call screen.





# address book

---

You can store a contact list of names, phone numbers, and email addresses in your phone's electronic address book.

## view contact list

Tap  in the global navigation bar to open the address book. To change the way your contact list is shown, tap , tap **Setup**, then tap the **Default List Display** drop-down menu to select **List View** or **Thumbnail View**.

## use category views

Defining categories for your contacts helps you manage address book information. You can classify contacts in different categories according to your communication

needs, and see contacts by category. Your phone provides the following basic categories:

**All**– Lists all contacts stored on your phone and on your SIM card.

**Unfiled**– Lists contacts stored on your phone that are not assigned to a user-defined category. This is the default category setting for new contacts.

**SIM Card**– Lists contacts stored on your SIM card.

In the contact list, tap the category button in the bottom button bar and select a category name to see only the contacts in that category.

**Tip:** To **create** and/or **edit** your own user-defined categories, see page 52.



## view and edit contact details

- 1 In the contact list, tap a contact name to see its details.
- 2 Tap **Edit** to edit the contact. Your phone shows complete contact details.
- 3 To edit contact information, tap the direct line in the field you want to edit.
- 4 When you are finished editing contact information, tap **Done** to store your changes and return to the contact list.

## add new contact

Contacts can be stored to phone memory or SIM card memory. To set the default storage location, see page 51.

**Note:** You can enter only a name and a single phone number for each contact that you store on the SIM card.

- 1 Tap  in the global navigation bar to open the address book.
- 2 Tap , then tap **New Contact**.
- 3 On the new contact screen, tap the **Photo** field to assign a picture ID to the entry. Your phone shows the picture when you receive a call from this contact.



First Name: \_\_\_\_\_

Last Name: \_\_\_\_\_

 <Mobile>

 <Home>

 <Work>

 <Fax>

 <Email>



Category: Unfiled 

 Done 

- 4 Tap the direct line in a field to enter contact details. Pull down the scroll bar to see additional fields.
- 5 To set a distinctive ringtone for the contact, tap the **RingTone** field and select **Browse**. Scroll to select the desired tone and tap **OK**. Your phone sounds the ringtone when you receive a call from this contact.
- 6 When you are finished entering information, tap **Done** to store the contact.

## create group





You can create a group mailing list consisting of multiple contacts stored in the address book. Groups make it easy for you to send a message to multiple recipients simultaneously.

- 1 Tap  in the global navigation bar to open the address book.
- 2 Tap , then tap **New Distribution List**.
- 3 Tap **Messaging** or **Email** to specify the default type of message to send to the group, then tap **OK**. You must enter a name for the group, and the group must contain at least one member.
- 4 When you finish entering information, tap **Save** to store the group.

## call or send message

- 1 Tap  in the global navigation bar to open the address book.
- 2 Tap a contact name to see its details.



### 3 In the details list:

- Tap the phone number following the mobile phone indicator  to call the contact's mobile phone. Other indicators may identify other numbers stored for the contact (such as home, work, or fax).
- Tap the message indicator  to the **right** of a phone number to send an SMS or MMS message to the number.
- Tap the email address following the email indicator  to send an email message to the address. Alternatively, tap the message indicator  to the **right** of the email address to send an MMS message to the address.

## search

**Tip:** To quickly search for a contact by name, tap the quick search icon in the lower right corner of the contact list, then enter the first few letters of the name you want.

To do a comprehensive search of the contact list by name, number, or other information stored for a contact:



- 1 Tap  in the global navigation bar to open the address book.
- 2 Tap , tap **More**, then tap **Find Contacts**.
- 3 Select **Contact's Name**, **Number**, or **Other**, enter the desired information in the **Search Text** field, then tap **Find**.

Your phone shows the search result, or notifies you that no match can be found.



To continue searching, tap **Find New**.

To return to the contact list, tap .

## sort

- 1 Tap  in the global navigation bar to open the address book.
- 2 Tap , then tap **Setup**.
- 3 Tap the **Sort Names By** drop-down menu to sort the contact list by **First Name** or **Last Name**.
- 4 Tap **Save** to save the setting.



## delete contact

- 1 Tap  in the global navigation bar to open the address book.
- 2 Tap , then tap **Delete Contacts**.
- 3 Check the contact(s) you want to delete, then tap **Delete**.
- 4 Tap **OK** to confirm the deletion.

## storage location

Contacts can be stored to phone memory or SIM card memory. You can set the default memory location where new address book contacts are stored.



**Note:** You can enter only a name and a single phone number for each contact that you store on the SIM card.

- 1 Tap  in the global navigation bar to open the address book.
- 2 Tap , then tap **Setup**.
- 3 Tap the **Default Memory Location** drop-down menu to set the default memory location.
- 4 Tap **Save** to save the setting.

## copy contacts

You can copy contacts between your phone and SIM card. This procedure does **not** delete the original contact.

**Note:** The SIM card can store only a name and one phone number per contact. When you copy an entry from the phone to the SIM card, your phone prompts you to specify the number you want to store for the contact.

- 1 Tap  in the global navigation bar to open the address book.
- 2 Tap , then tap **Copy to SIM/Phone**.
- 3 Select **Phone to SIM** or **SIM to Phone**, then tap **OK**.
- 4 Check the number(s) you want to copy. If you copy from the SIM card to phone memory, specify the number type.

- 5 Tap **OK** to copy the numbers to the new location.

**Note:** The number of entries you can store on your SIM card depends on the SIM card capacity. The types of entries that can be copied to the SIM card may vary depending on the function of the SIM card.

## categories

You can create user-defined categories to organize your contacts.

### create a new category

- 1 Tap  in the global navigation bar to open the address book.
- 2 Tap the category button in the bottom button bar, then tap **Edit Category**.

- 3 Tap , then tap **New** to create a new category.
- 4 Tap the **Name** field to assign a name to the category, then tap **OK**.
- 5 Tap **Add Members**, then check the contacts you want to add to the category.
- 6 Tap **Select** to add the selected contacts to the category.



## add members to a category

- 1 Tap  in the global navigation bar to open the address book.
- 2 Tap the category button in the bottom button bar, then tap **Edit Category**.
- 3 Select the category, tap **Add Members**, then check the contacts you want to add to the category.

- 4 Tap **Select** to add the selected contacts to the category.

## set category ringtone

You can set a special ringtone to play when you receive calls from contacts in a specific category.

- 1 Tap  in the global navigation bar to open the address book.
- 2 Tap the category button in the bottom button bar, then tap **Edit Category**.
- 3 Select the category, tap , then tap **Category RingTone**.
- 4 Tap the **RingTone** drop-down menu, then tap **Browse** to look for the ringtone you want to use.

5 Scroll to select the desired ringtone, then tap **OK**.

6 Tap **Save** to save the setting.

## delete a category

You can delete a user-defined category in your address book. Any contacts assigned to the deleted category revert to the default **Unfiled** category setting.

**Note:** You can **not** delete the predefined categories in your address book.

1 Tap  in the global navigation bar to open the address book.

2 Tap the category button in the bottom button bar, then tap **Edit Category**.

3 Select the category, tap , then tap **Delete**.

4 Tap **OK** to confirm the deletion.

## check capacity

You can see the number of address book entries currently stored on the phone and SIM card, and the total number of entries you can store on the SIM card.

1 Tap  in the global navigation bar to open the address book.



2 Tap , tap **More**, then tap **Memory Status**. Your phone shows the number of phone and SIM card contacts, and the SIM card capacity (*number of contacts*).

3 Tap  to return to the address book.



## share contact

You can share contact information with others by sending the data as a vCard to another phone, PC, or hand-held device.

- 1 Tap  in the global navigation bar to open the address book.
- 2 Tap the name of the contact you want to send. Your phone shows contact details.
- 3 Tap , then tap **Share**.
- 4 Tap **Bluetooth**, then tap **OK** to exchange the data through a Bluetooth™ wireless connection.

**or**

Tap **Message** or **Email**, then tap **OK** to send the contact data in an MMS or email message.

- 5 Complete the setup procedure for the transfer method you selected.
- 6 Tap **OK** to send the contact information in a vCard.



For more information about using a Bluetooth wireless connection, see page 116.

## synchronize contacts

You can synchronize contacts with your PC through a Bluetooth wireless connection or USB cable connection using Motorola mobile PhoneTools software. For more information, see page 120.

# owner's information

You can store information about yourself in the address book. Then, if you lose your phone, the person who finds it can contact you to return the phone.

- 1 Tap  in the global navigation bar to open the address book.
- 2 Tap , then tap **Owner's Information**.
- 3 If owner's information is stored, the phone shows the owner's contact details. Tap **Edit** to edit the owner's information.
- 4 If owner's information is not stored, the phone shows the owner's information entry screen. Enter information as you would for a new contact (see page 48.).
- 5 When you are finished entering information, tap **Done** to store the owner's information.

You can send and receive short text-based SMS messages, and multimedia MMS messages containing media objects such as photos, pictures, animations, sounds, voice records, and video clips.

**Note:** Your phone sends an SMS text message by default, unless you insert multimedia content or perform a function reserved for MMS multimedia messages.

Instant messaging lets you exchange messages in real time with other wireless phone users.

## message center

**Note:** You must set up your message service **before** you can send and receive messages. Usually, your service provider has already set up the message inbox for you. For setup instructions, see page 69.

Tap  in the global navigation bar to open the message center.

Your messages are stored in different folders in the message center. The number to the right of each folder name indicates the

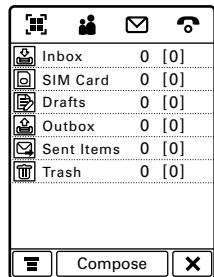

number of messages it contains. Tap a folder to see its contents.

The message center contains the following folders:

**Inbox** – Stores SMS and MMS messages you have received. You can move messages from the Inbox to other folders, including personal folders that you create. For more information about creating folders, see page 67.

**SIM Card** – Contains SMS messages stored on your SIM card. You can move these messages to other folders.

**Drafts** – Temporarily stores messages that you are still writing.

**Outbox** – Stores your messages that have not yet been sent.



**Sent Items** – Stores copies of messages you have sent.

**Trash** – Stores messages you have deleted. If you have not permanently deleted a message, you can retrieve it.

You can create additional personal folders to organize and store your messages.

## signature

You can store your signature, and automatically or manually append it to the messages you send.

- 1 Tap  in the global navigation bar to open the message center.
- 2 Tap , then tap **Signature Editing** to open the signature editing screen.

- 3 Tap the direct line in the **Signature Content** field to enter your signature.
- 4 If you want your phone to automatically add your signature to all outgoing messages, tap the check box  below the signature. A check mark  indicates that automatic signature is activated.
- 5 Tap **Save** to store your signature.

## send text message



You can send an SMS short text message to other wireless phone users, and to email addresses.

To compose and send an SMS message:

- 1 Tap  in the global navigation bar to open the message center.
- 2 Tap **Compose**.

- 3 Tap the message field, then tap the text entry method drop-down menu at the bottom of the screen and select an entry method to enter text in the message field. When you are finished, tap  in the lower right corner of the screen to hide the text entry keyboard or pad.

Alternatively, you can tap , tap **Load**, then tap **Quick Text** to insert a prewritten quick text note in the message field

- 4 Tap **To** to select contacts from your address book, or tap the direct line in the **To** field to enter a phone number or email address.
- 5 Tap **Send** to send the message.

When composing an SMS message, you can tap  to perform various operations on the message prior to sending it. The SMS menu can include the following options:



options	
<b>Load</b>	Insert a quick text note or auto-signature in the message.
<b>Save To</b>	Save the message to the <b>Drafts</b> folder.
<b>Send Options</b>	<b>Receipt Request:</b> Request a delivery report for the message. <b>Expire After:</b> Set the expiration time for an undelivered message.
<b>Delete</b>	Delete the message.

## send multimedia message





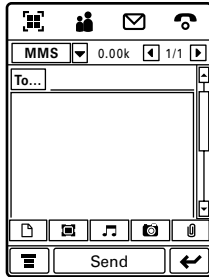

A *Multimedia Messaging Service (MMS) multimedia message* contains one or more pages with text and embedded media objects (including photos, pictures, animations, sounds, voice records, and/or video clips). You can send an MMS message to other wireless phone users, and to email addresses.

To compose and send an MMS message:

- 1 Tap  in the global navigation bar to open the message center.
- 2 Tap **Compose** to open the message composition screen.
- 3 Tap the message field, then tap the text entry method drop-down menu at the bottom of the screen and select an entry method to enter text in the message field. When you are finished, tap  in the lower right corner of the screen to hide the text entry keyboard or pad.



- 4 Tap a button in the media toolbar at the bottom of the screen to insert media objects on the page or attach files to the message.
  - Tap  to insert a picture, video, or new drawing on the page.
  - Tap  to insert a sound file or new voice record on the page.
  - Tap  to activate the camera, take a photo or record a video clip, and insert it on the page.
  - Tap  to attach a contact, event, task, or file to the message.
- 5 To add a new page after the current page, tap . Repeat steps 3 and 4 to enter contents for the new page.

- 6 Tap **To** to select contacts from your address book, or tap the direct line in the **To** field to enter a phone number or email address.
- 7 Tap **Cc**, **Bcc**, or **Subject** to enter additional recipients or a message subject. (Use the MMS menu, described below, to show or hide these fields.)
- 8 Tap **Send** to send the message.

When composing an MMS message, you can tap  to perform various operations on the message prior to sending it. The MMS menu can include the following options:

options	
<b>Load</b>	Insert a quick card, quick text note, or auto-signature in the message.
<b>Save To</b>	Save the message to the <b>Drafts</b> folder, or save it as a quick card.
<b>Page Duration</b>	Set the number of seconds each page is shown.
<b>Preview</b>	Preview the MMS message.
<b>Show</b>	Show or hide the <b>Cc</b> , <b>Bcc</b> , and/or <b>Subject</b> header fields. Use <b>Cc</b> or <b>Bcc</b> to carbon-copy or blind-carbon-copy the message to additional recipients. Use <b>Subject</b> to specify a subject for the message.



options	
<b>Send Options</b>	<p><b>Receipt Request:</b> Request a delivery report for the message. </p> <p><b>Expire After:</b> Set the expiration time for an undelivered message.</p> <p><b>Priority:</b> Set message priority.</p> <p><b>Expire After:</b> Set a time and date for your phone to send the message.</p>
<b>Delete</b>	Delete the current page, delete an object on the page, or delete the message.

## unsent messages

Outgoing messages that failed to send or have not yet been sent are stored in the outbox.

On the message center screen, tap **Outbox** to see its contents. Messages in the outbox are sorted from newest to oldest.

Tap a message to read it. You can edit the message while it is open.

## tips for sending messages

- When you enter an SMS text message, a counter at the top right corner of the display shows the number of characters left on the current page, and the number of pages you have written (*character# / page#*). Network charges are based on the number of pages sent.
- When you enter an MMS multimedia message, a counter at the top of the display shows the current message size in kilobytes. Another counter shows the number of pages.
- When you manually enter phone numbers and/or email addresses in the **To** field, you must insert a comma between each entry.

## receive message



Your phone shows the new message icon  in the global navigation bar when you receive a new message.

Tap  to see message details (sender, subject, time, and size).

Tap **Read** to read an SMS message. Tap **Download** to download an MMS message to your phone, then tap **Read** to read it.

Tap  to return to the previous screen without reading the message. The message is stored in the inbox.

Tap  to perform various operations on the message. The received message menu can include the following options:

<b>options</b>	
<b>Reply With Original</b>	Include a copy of the original message in your reply. (SMS only)
<b>Call Back</b>	Call a phone number embedded in the message header or message body.
<b>Forward</b>	Open a copy of the message, with an empty <b>To</b> field.
<b>Save Address</b>	Save the sender's email address.
<b>Save Object</b>	Save a media object in the message. (MMS only)

<b>options</b>	
<b>Save As Quick Card</b>	Save the current MMS page as a quick card. You can insert the quick card into MMS messages that you compose. (MMS only)
<b>Move To Folder</b>	Move the message to another folder.
<b>Delete Message</b>	Delete the message.

When your phone shows **Memory is Full!**, you must delete some existing messages from your inbox, outbox, or drafts folder to receive new messages.

## read and reply

Messages that you receive are stored in the inbox.

On the message center screen, tap **Inbox** to see its contents. Messages in the inbox are sorted from newest to oldest.

Tap a message to read it. Your phone shows the sender's name (if stored in your address book) or phone number, the message contents, and the time it was sent.

- Tap **Reply** to send a reply to the message
- Tap ← to return to the previous screen without making any changes.

## store message object



To store a media object contained in a multimedia message, tap and hold the object to open a pop-up menu, then select **Save** to store the object on your phone.

If the object is contained in a message attachment, tap and hold the attachment to open a pop-up menu, then select **Save** to store the object.

## sort messages

On the **Inbox**, **Outbox**, or **Trash** screen, tap ≡, then tap **Sort By** to sort messages by **Time**, **Subject**, or **Name**.

## drafts

Messages that you are still writing are stored in the drafts folder.

On the message center screen, tap **Drafts** to see its contents. Tap a message to read it. You can edit the message while it is open, and then send it immediately.

## deleted messages

Messages that you delete are stored in the trash folder.

On the message center screen, tap **Trash** to see its contents. Tap a message to read it. You can edit the message while it is open.

Tap **Delete All** to permanently delete all messages in the trash folder.



## messages on SIM card

On the message center screen, tap **SIM Card** to see the messages stored on your SIM card. Tap a message to read it.

## create folder

You can create one or more personal folders to store your messages, and lock your personal folders to prevent other users from reading the messages stored in them.

To create a personal folder:

- 1 Tap  in the global navigation bar to open the message center.
- 2 Tap , then tap **New Folder**.
- 3 Tap the direct line in the **Name** field to enter a name for the folder.

4 To lock the folder to prevent unauthorized access, tap the check box  beside **Protected by Lock Code?** A check mark  indicates that the folder lock feature is activated.

5 Tap **Done** to save the folder.

The personal folder is listed on the message center screen along with your other folders. If the personal folder is locked, your phone prompts you to enter the phone unlock code when you try to open the folder or move a message to it. Enter your unlock code to open the folder.

To **edit** a personal folder, open it and tap , then tap **Folder Setup**. You can change the folder name, and turn the folder lock feature on or off as desired.



To **delete** a personal folder, open it and tap , then tap **Delete Folder**. Tap **OK** to confirm the deletion.

**Note:** You must remove all messages from a personal folder in order to delete it.

## move messages

You can move messages between folders. For example, you can move a message from the inbox to the SIM card folder and take it with you when you use your SIM card in another phone, or move it to a locked personal folder to prevent others from reading it.



To move messages to another folder:

- 1 Tap  in the global navigation bar to open the message center.
- 2 Open the folder that contains the message(s) you want to move.
- 3 Tap , then tap **Move**.
- 4 Tap the check box  beside each message you want to move, or tap the check box beside **All** to select all messages. A check mark  indicates that the message is selected.
- 5 Tap **OK** to open the move to folder screen.
- 6 Tap the destination folder, then tap **OK** to move the messages.

**Tip:** To quickly move a single message, tap and hold the message to open a pop-up menu, then select **Move to Folder**.

## set up message service



- 1 Tap  in the global navigation bar to open the message center.
- 2 Tap , then tap **Service Setup**.
- 3 Tap **Short Message** or **Multimedia Message** to configure your SMS or MMS inbox settings as described in the following section.
- 4 When you're finished, tap **OK** to save your settings.

## SMS setup options



**Note:** Actual field names and values may vary depending on the technologies available to your service provider. Some settings may not be available for all phone models.

options	
<b>Server Center Number</b>	Number of the center that handles your outgoing text messages.
<b>Expire After</b>	Number of days your network should attempt to send undelivered text messages.

## MMS setup options



**Note:** Actual field names and values may vary depending on the technologies available to your service provider. Some settings may not be available for all phone models.





options	
<b>Default Profile</b>	Select an MMS network profile. (See next section to edit profile settings or create a new network profile.)
<b>Expire After</b>	Number of days your network should attempt to send undelivered MMS messages.



options	
<b>Auto Download</b>	Automatically download MMS messages to your phone. You can set this function to be disabled when roaming, and set a maximum file size for auto-downloaded messages.
<b>Show My Number</b>	Send your number with outgoing MMS messages.
<b>Allow Delivery Report</b>	Send a delivery report for an incoming MMS message when requested.
<b>Block Senders</b>	Block incoming MMS messages from specific senders.
<b>Reject Read Reply Request</b>	Do not send a reply to the sender when you read a new received message.
<b>Auto Retry</b>	Automatically attempt to resend messages when delivery fails.

## MMS network profile setup

You can edit an existing MMS network profile or create a new MMS network profile.

- 1 Tap  in the global navigation bar to open the message center.
- 2 Tap , then tap **Service Setup**.
- 3 Tap **Multimedia Message** to open the MMS inbox setup editor.
- 4 Tap the folder tree icon  in the **Default Profile** field to open the MMS profile list.
- 5 To edit an existing MMS network profile, highlight the profile, tap , then tap **Edit**.

**or**

To create a new MMS network profile, tap , then tap **New**.

- 6 When you're finished, tap **Save** to save your settings.

You must enter the following configuration settings. If necessary, contact your service provider to obtain the following information:

options	
<b>Profile Name</b>	Enter the profile name.
<b>MMSC</b>	Select the server you want to use (information may be viewable only).
<b>Network Profile</b>	Select a network connection profile to connect to the Internet. For more information, see page 100.
<b>WAP Gateway IP</b>	Primary service gateway IP address for your WAP service provider.

options	
<b>Port Number</b>	Primary service port number.
<b>WAP Gateway IP(2)</b>	Secondary service gateway IP address.
<b>Port Number</b>	Secondary service port number.
<b>Max Sending Size</b>	Maximum size of incoming multimedia message to be downloaded to your phone.



## browser messages



Your network's Web server can send you *browser messages* that you read in your micro-browser.

Your phone shows the new message icon  in the global navigation bar when you receive a new browser message. Tap **Read** to read the message.

You must activate the feature to receive browser messages.

- 1 Tap  in the global navigation bar to open the message center.
- 2 Tap , then tap **Service Setup**.
- 3 Tap **Browser Message** to open the WAP push editor.
- 4 Tap **Receive All** to receive all browser messages, or **Restricted** to restrict the browser messages you receive.
- 5 Tap **Save** to save the setting.





## information service messages



*Information service messages* are broadcast messages that you can receive, such as stock updates, news headlines, or sports scores.

Your phone shows the new message icon  in the global navigation bar when you receive a new information service message. Tap **Read** to read the message.

**Note:** You must set up your information service **before** you can receive information service messages. Usually, your service provider has already set up the information service for you.

- 1 Tap  in the global navigation bar to open the message center.
- 2 Tap , then tap **Service Setup**.
- 3 Tap **Info Service** to open the info service setup editor.
- 4 Tap **Service On** to activate info service on your phone.
- 5 Tap **Active Channels...** to set subscription channels.
- 6 Tap , then tap **New Channel** to add a new channel.  
**or**  
Tap , then tap **Delete Channels** to delete one or more channels.
- 7 Tap **Save** to save your settings.
- 8 Tap **OK** to exit the active channels menu.
- 9 Tap **Languages** to set the languages in which you receive cell broadcasts.
- 10 Set the first and second languages, then tap **Save** to save the language settings.
- 11 Tap **Save** to save your info service settings.

# office applications

---

## email



You can send and receive email messages with your wireless phone.

**Tip:** To send and receive email messages, you must have an Internet connection, and have a POP3, IMAP, or SMTP email account on the Internet or your service provider's network. If necessary, see page 100 for information on how to set up a network connection profile.

## mailboxes and folders

**Note:** You must set up your email mailbox **before** you can send and receive email messages. Usually, your service provider has already set up the email mailbox for you. For setup instructions, see page 78.

Tap  **Email** in the application launcher screen to launch the email application.

Email messages are stored in different folders in your email mailbox:

**Inbox** – Email messages you have received.

**Outbox** – Your email messages that have not yet been sent.

You may have additional folders in an email mailbox, such as **Drafts**, **Sent Items**, **Trash**, or personal folders that you create.

If you have separate mailboxes for different email accounts, tap the **Mailbox** field at the top of the email message screen to select the mailbox you want to use. Your phone shows

the folders associated with the selected mailbox.



## send an email message





You can send an email message to one or more recipients. You can manually enter each recipient's email address, or select addresses from the address book.

When you manually enter email addresses, you must insert a comma, semicolon, or colon between each address.

To compose and send an email message:

- 1 Tap  **Email** in the application launcher screen to launch the email application.
- 2 Tap , then tap **New Email** to open the email message composition screen.
- 3 Tap the direct line in the **Subject** field to enter a subject for the message.

- 4 Tap the message field, then tap the text entry method drop-down menu at the bottom of the screen and select an entry method to enter text in the message field. When you are finished, tap  in the lower right corner of the screen to hide the text entry keyboard or pad.
- 5 Tap **To** to select contacts from your address book, or tap the direct line in the **To** field to enter an email address.
- 6 Tap **Send** to send the message.

When composing an email message, you can tap  to perform various operations on the message prior to sending it. The email menu can include the following options:

options	
<b>Save to Draft</b>	Save the message to the <b>Drafts</b> folder.

options	
<b>Insert Signature</b>	Append your signature to the end of the message.
<b>Cc and Bcc Options</b>	Show <b>Cc</b> and/or <b>Bcc</b> header fields to carbon-copy or blind-carbon-copy the message to additional recipients.
<b>Attachments</b>	Attach a contact, calendar event, task, or media object to the message.
<b>Priority</b>	Set message priority.
<b>Delete Attachment</b>	Delete message attachments.



## receive an email message



Email messages that you receive are stored on your service provider's email server until you download them to your phone.

Tap  **Email** in the application launcher screen to launch the email application. Tap **Send/Rec.** to download new received messages to your phone.

When you download an email message:

- Tap  to see message details (sender, subject, time, and size).
- Tap the message to read it.
- Tap **Reply** to send an email reply to the message.
- Tap  to perform various operations on the message. The received email message menu can include the following options:

options	
<b>Save File</b>	Save a media object attached to the message.

options	
<b>Move To Folder</b>	Move the message to another folder.
<b>Delete Message</b>	Delete the message.

## create a personal folder

The procedures for creating and using a personal folder are similar to the corresponding message center procedures. See page 68 for more information.

## set up the email mailbox

If the phone cannot locate your email mailbox, it opens the mailbox setup screen for you to configure your mailbox settings.

## automatic setup

- 1 Select your email service provider from the mailbox setup list, then tap **OK**.
- 2 Enter your User **Name** and **Password** in the appropriate fields, confirm your password in the **Re-enter Password** field, then tap **OK**.
- 3 To edit email sending, receiving, signature, connections options, tap the mailbox name you wish to edit. Then enter settings as described in the following section.

## manual setup

If your service provider is not listed on the mailbox setup list, you can manually set up your email mailbox as follows:

- 1 Tap **Setup Manually** on the mailbox setup screen to manually enter email settings, then tap **OK**.



- 2 Tap the **Mailbox Name** field and enter your mailbox name.
- 3 Tap **Send Setup** and **Receive Setup** to configure your email sending server and receiving server settings as described below.
- 4 Tap **Signature Setup**. If you want your phone to automatically append your signature to all outgoing email messages, tap the check box  beside **Add signature to all outgoing messages**. A check mark  indicates that automatic signature is activated.
- 5 Tap the signature field and enter your signature.
- 6 Tap **OK** to save your signature.
- 7 Tap **Connections Setup**, then select the type of connection desired and tap **OK**.
- 8 Tap **OK** to store your mailbox settings.

## send setup options

**Note:** Actual field names and values may vary depending on the technologies available to your service provider. Some settings may not be available for all phone models.

options	
<b>Server</b>	IP address or host name that handles your outgoing email.
<b>Port</b>	Port number for sending host.
<b>Email</b>	Your email address.
<b>Nickname</b>	Name to be inserted before your return address, if desired.

## options

**Authentication** Set **Authentication** to **On** if you need a user name and password to access your outgoing email server.

Set **Same as Receive setup** if user name and password are the same as for your incoming email server.

Otherwise, enter your outgoing email server **User Name** and **Password**, and confirm your password in the **Re-enter Password** field.

## receive setup options

**Note:** Actual field names and values may vary depending on the technologies available to your service provider. Some settings may not be available for all phone models.

### options

<b>POP3 or IMAP</b>	Select the protocol to communicate with the receiving host: <b>POP3</b> or <b>IMAP</b> .
---------------------	--

<b>Server</b>	IP address or host name that handles your incoming email.
---------------	---

<b>Port</b>	Port number for receiving host.
-------------	---------------------------------

<b>User Name</b>	Your user name.
------------------	-----------------

<b>User Password</b>	Your user password.
----------------------	---------------------

<b>Re-enter Password</b>	Confirm your user password.
--------------------------	-----------------------------

<b>options</b>	
<b>Check All Folders</b>	Select to check all folders for email.  Set the <b>Root Folder Path</b> that your phone should search.
<b>Save Special Folders</b>	Select to specify additional email folders.  You can set the <b>Sent Items Path</b> and the <b>Drafts Path</b> .
<b>Message Size Limitation</b>	Maximum size of an email message to be downloaded to your phone.

<b>options</b>	
<b>Keep on Server</b>	Select to save copies of your email messages on the remote server. (For POP3, prevents message deletion on remote server after message is downloaded to your phone. For IMAP, prevents message deletion on remote server after message is deleted on your phone.)

# calendar

You can use your phone's calendar to schedule and organize events such as appointments and meetings.

Tap  **Calendar** in the application launcher screen to schedule or review calendar events.

## month view

The calendar initially shows a calendar for the month.

Tap ◀ or ▶ to go to the previous or next month.

An indicator in the lower left corner of the date box indicates that one or more events are scheduled for the day.



Tap the date box to see the day's events.  
Tap an event to see event details.

## week view

Tap the **Month** button in the bottom button bar, then select **Week** to see the week view.

Tap ◀ or ▶ to go to the previous or next week.

Vertical bars indicate scheduled events for the day. A horizontal bar below the date indicates a full-day event. Tap the day to see the day's events. Tap an event to see event details.

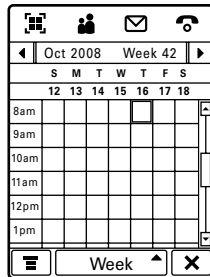

## day view

Tap a day in the month or week view to see the day's events.

Alternatively, you can tap the **Month** button in the bottom button bar, then select **Day** to see the highlighted day.

Tap ◀ or ▶ to go to the previous or next day.

Tap an event to see event details.

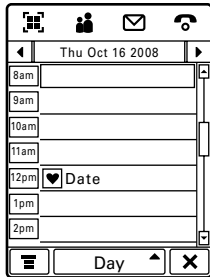

## add new event

You can create an event, and set your phone to remind you when the event time arrives.

- 1 Tap  **Calendar** in the application launcher screen to open the calendar.

- 2 Tap the day to which you want to add an event. Your phone lists the day's events.

- 3 Tap , then tap **New Event** to open the new event editor.

**Shortcut:** Tap an hour in the day view to add an event at that time.



- 4 Tap the direct line in a field to enter event details. Pull down the scroll bar to see additional fields.
- 5 When you're finished entering information, tap **Save** to store the event.



## schedule a meeting



You can send a meeting request message to other wireless phone users, and to email addresses. The meeting is added to your calendar, and to the calendars of the message recipients.

- 1 Tap  **Calendar** in the application launcher screen to open the calendar.
- 2 Tap , then tap **New Meeting Request** to open the meeting request editor.
- 3 Tap the direct line in a field to enter meeting details. Pull down the scroll bar to see additional fields.
- 4 When you're finished entering information, tap **Send** to send the meeting request and add the meeting to your calendar.

## edit an event

- 1 Tap the event to see event details.
- 2 Tap **Edit** to open the event editor.
- 3 Tap the direct line in a field to edit its contents. Pull down the scroll bar to see additional fields.
- 4 When you're finished editing information, tap **Save** to store the event.

## delete an event

- 1 Tap the event to see event details.
- 2 Tap , then tap **Delete**.
- 3 Tap **OK** to confirm the deletion.

Alternatively, to delete an event, tap and hold the event title, then select **Delete** from the pop-up menu.

## dismiss reminder alarm

When you set a reminder alarm for an event, the phone shows an event reminder and sounds a reminder alarm.

Tap **Snooze** to turn off the reminder alarm for a short period of time. The reminder alarm sounds again when the snooze period expires.



Tap **Cancel** to dismiss the reminder alarm.

If you have more than one event set up for the same time, the phone shows each event in sequence. As you read and dismiss each event reminder, the next event is shown.

## change the calendar setup



You can set the calendar's default view (month, week, day), weekly start day, daily start time, reminder snooze period, event storage period, alarm timeout, and lunar calendar.

When you select **Alarm When Power Off** in the calendar setup screen, your phone turns itself on if necessary to remind you about scheduled events.

- 1 Tap  **Calendar** in the application launcher screen to open the calendar.
- 2 Tap , then tap **Setup**.
- 3 Tap a field to change its setting. Pull down the scroll bar to see additional fields.
- 4 When you're finished changing settings, tap **Save** to store the settings.

## share event information

You can share calendar events with others by sending the data as a vCalendar entry to another phone, PC, or hand-held device.

- 1 Tap  **Calendar** in the application launcher screen to open the calendar.
- 2 Tap the name of the event you want to send. Your phone shows event details.
- 3 Tap , then tap **Share**.
- 4 Tap **Bluetooth**, then tap **OK** to exchange the data through a Bluetooth™ wireless connection.

**or**

Tap **Message** or **Email**, then tap **OK** to send the event data in an MMS or email message.

- 5 Complete the setup procedure for the transfer method you selected.
- 6 Tap **OK** to send the event information in a vCalendar entry.

For more information about using a Bluetooth wireless connection, see page 116.

## synchronize calendar entries





You can synchronize calendar entries with your PC through a Bluetooth wireless connection or USB cable connection using Motorola mobile PhoneTools software. For more information, see page 120.



# tasks

You can create and review a checklist of tasks you need to perform, and set your phone to notify you when task deadlines arrive.

## add new task

- 1 Tap  **Tasks** in the application launcher screen to open the task list.
- 2 Tap , then tap **New**.
- 3 Tap the direct line in a field to enter task details.
- 4 When you're finished entering information, tap **Save** to store the task.

## view tasks

Tap  **Tasks** in the application launcher screen to open the task list. Tap a task to see its details. Tap the check box  beside the task name to indicate that you've completed the task.

Tap and hold on a task to open a pop-up menu from which you can **Share**, **Edit**, or **Delete** the task.

To sort the task list, tap the *sort order* button in the bottom button bar. You can choose to see **All Tasks**, **Unchecked** tasks, **Due Tasks**, or **Completed** tasks.

Tap  to perform various operations on the task list.

## notes

You can write and store notes on your phone.

- 1 Tap  **Notes** in the application launcher screen to open the notes editor.
- 2 Tap the text line and enter the information on the keypad you want to record.
- 3 When you are finished entering information, tap to close the keypad and tap **Save**.
- 4 Enter a name, storage location, and type for the note.
- 5 Tap **Save** to save the note.

To read a note that you have saved, tap , tap **Open**, then select the note you want to open.

## viewer

The viewer application provides an easy way for you to read documents stored on your phone.

Tap  **Viewer** in the application launcher screen to open the viewer application.

Your phone shows the file folders included on your phone (see page 91 for folder descriptions). Tap a folder to see its contents. Tap a document to open it in the viewer.

You can scroll through a large document by dragging the stylus across the screen and “dragging” the document in the direction you want to move.

To zoom in or out on a document, tap the center of the screen, release, then quickly tap and hold the screen and drag the stylus up or down to adjust the document size.

To reflow the text or make other view adjustments, tap  to open the menu, tap **View**, then tap **Rotate Screen**, **Reload** the document, **Fit to Width**, or **Fit to Height**.

For more information about how to use the viewer, tap  to open the menu, then tap **Help**.

## calculator

You can use your phone as a calculator.

Tap  **calculator** in the application launcher screen to open the calculator.

Tap the numeric and calculation keys to perform a calculation.

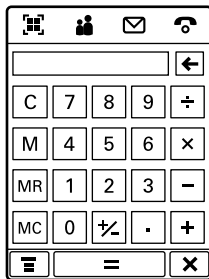

Tap **=** to calculate the result.

Tap **C** to clear the calculation. Tap **←** to clear the last entry, one digit at a time, when performing a calculation.

Tap **×** to exit the calculator and return to the application launcher screen.

Tap the following keys to perform the described functions:

functions	
<b>+/-</b>	Change the entry's sign (positive/negative).
<b>M</b>	Store the current number in memory.
<b>MR</b>	Show the stored number.
<b>MC</b>	Clear the stored number.

# alarm clock

Your phone has an alarm clock with two separate alarms that you can set to alert you at the time(s) you specify.

- 1 Tap  **Alarm Clock** in the application launcher screen to open the alarm clock setup screen.
- 2 Tap the check box  beside an alarm to activate it. A check mark  indicates that the alarm is activated.

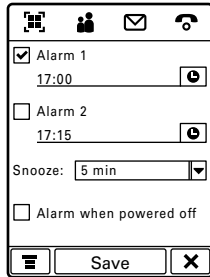

- 3 Tap below the alarm name to set the alarm time. Set the desired time, then tap **OK** to store it.
- 4 Tap **Snooze** to set the snooze period.
- 5 Tap **Save** to store your settings.

When the alarm time arrives, your phone shows an alarm reminder and sounds an alert.

Tap **Snooze** to turn off the event reminder for a short period of time. The alarm sounds again when the snooze period expires.

Tap **Dismiss** to turn off the alarm.

When you select **Alarm When Power Off** in the alarm clock setup screen, your phone turns itself on if necessary to alert you when the alarm expires.

# file manager

The file manager application makes it easy for you to create personal folders to store and manage your files and applications.

Tap  **File Manager** in the application launcher screen to open the file manager.

Your phone lists the available storage devices (such as **Phone** memory, and an optional removable **Memory Card**). Tap a storage device to see the root directory for the device.

Your phone includes several predefined folders:

**MyImages** Stores photos that you take with your phone's  **Camera**.

**MyAudio** Stores ringtones you download to your phone, and sound files you record with the  **Recorder** application.

**MyVideo** Stores video clips that you record with your phone's  **Camera**.

**MyNotes** Stores notes that you write with the  **Notes** application.



**MyPrograms** Stores applications that you download and install on your phone.

**Preload** Stores preloaded media files installed on your phone.

**Note:** Your phone's files and folders may differ from those listed above.



## edit files and folders

Tap and hold a file or folder to open a pop-up menu to perform various operations on the file/folder. The edit menu can include the following options:

options	
<b>Open With</b>	Specify the application your phone should use to open the file (files only).
<b>Share</b>	Send the file to another phone, PC, or hand-held device (files only).
<b>Install</b>	Install the selected file (files only). 
<b>Copy or Cut</b>	Copy or cut the file or folder to the clipboard. (Tap  , then tap <b>Paste</b> to paste the clipboard contents in the current folder.)

options	
<b>Move To</b>	Move the file or folder to a new location.
<b>Rename</b>	Rename the file or folder.
<b>Delete</b>	Delete the file or folder.
<b>Properties</b>	See information about the file or folder.

## create new folder

- 1 Tap  **File Manager** in the application launcher screen to open the file manager.
- 2 If necessary, tap the folder tree icon  to select the location (phone or memory card) where you want to create the folder.
- 3 Tap , then tap **New Folder**.
- 4 Enter a name for the folder.
- 5 Tap **Save** to save the folder.

## view

To change the way your files and folders are shown, tap , then select **List View** or **Thumbnail View**.

## sort

To change the way your files and folders are sorted, tap , then tap **Sort by**. You can sort files or folders by **Time**, **Name**, **Size**, or **Type**.

## search

To search for a specific file:

- 1 Tap , tap **More**, then tap **Search**.
- 2 Enter the name of the file in the **File Name** field.
- 3 Specify the file type in the **File Type** field.
- 4 Tap **Search** to begin the search.

If the file is found, the filename is listed. Tap the filename to open the file. Tap and hold the filename to see the file path.

If the file is not found, tap  to return to the file manager screen, or tap **Retry** to try another search.

## folder tree

Tap the folder tree icon  in the file manager screen to see the folder structure and organization of your phone, or a storage device connected to the phone.

## removable memory card



You can use an optional removable SD memory card or MMC memory card with your phone to store and retrieve multimedia objects (such as photos, video clips, and music files). To insert a memory card in your phone, see page 21.

Tap  **File Manager**, then tap the memory card's name to see its root directory.

**Tip:** Tap and hold on the memory card's name to open a pop-up menu to **Format** the memory card or see memory card **Properties**.

Tap  to perform various operations on the memory card. The storage device menu can include the following options:

options	
<b>New Folder</b>	Create a new folder on the memory card.
<b>List View</b> or <b>Thumbnail View</b>	See memory card files and folders in a text-based <b>List View</b> or graphic icon <b>Thumbnail View</b> .

options	
<b>Share</b>	Send a file to another phone, PC, or hand-held device.
<b>Move</b>	Move a file to a new location.
<b>Paste</b>	Paste the clipboard contents at the current location.
<b>Sort By</b>	Sort memory card files or folders by <b>Time</b> , <b>Name</b> , <b>Size</b> , or <b>Type</b> .
<b>Delete</b>	Delete a memory card file or folder.
<b>More</b>	<b>Search</b> for a memory card file or folder. Tap <b>Properties</b> to see information about a file or folder.



# business card reader

The business card reader application lets you use your phone's camera to capture a business card image, then store the card's information as a contact in the phone's electronic address book.

## capture business card image

Tap  **BCR (Business Card Reader)** in the application launcher screen to open the business card reader application.

**Tip:** Tap **Help** to see instructions on how to position and frame the business card that you want to capture.

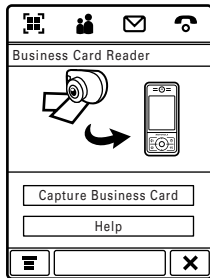

Slide the camera mode switch **down** to put the camera lens in macro mode.

Tap **Capture Business Card** to activate the camera and open the *Optical Character Recognition (OCR)* viewfinder.

Use the red border in the OCR viewfinder to vertically frame the business card you want to capture. Position the camera so that the card fills the frame without extending beyond the frame borders. The framing border and center indicator turn green when the business card is properly framed.

**Camera Mode Switch**  
**Up** = normal picture mode.  
**Down** = macro mode.

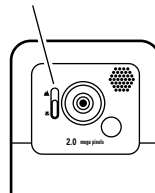

Your phone automatically captures a business card image when the card is properly framed in the OCR viewfinder. (To activate or deactivate the auto-capture feature, see “business card reader settings” on page 97).

If auto-capture is turned off, press the camera key, tap **Capture**, or press the center key  to capture the business card.

## edit business card information

Your phone interprets the text on the captured business card image, and sorts the text into logical categories.

The character recognition software may misinterpret a text string or assign it to the wrong category. On the edit business card screen, tap a category name to change the assigned category. Tap the direct line in a category to edit its contents. If more

categories are available, pull down the scroll bar on the right side of the screen to see and edit their contents.

To **add** another category to the list, tap , then tap **Add Items**.

To **delete** one or more categories from the list, tap , then tap **Delete Items**.

To **see the business card** while you edit its details, tap , then tap **Show Card Image**.

To **move** the card image, tap and drag the image in the direction you want to move.

To **zoom in/out** on the card image, tap , then tap **Zoom In** or **Zoom Out**. On the card image, tap the small box to the left of an outlined text string to see its assigned category and content in the upper part of the screen.

When you're finished editing business card details, tap **Save** to save the information as a new contact in your phone's address book.

## business card reader settings

Tap , then tap **Setup** to adjust business card reader settings.

Select **Auto Capture** to have your phone automatically capture a business card image when the card is properly framed in the OCR viewfinder.

You can set your phone to automatically **Delete Image** or **Save Image** for a captured business card after you save its contact information in the address book.

Use the **Always Show** list to select information categories that you always want to show in the edit business card screen.

## recognize stored business card

To recognize and edit a business card image that you've already captured and stored on your phone, tap  **BCR (Business Card Reader)** in the application launcher screen to open the business card reader application, tap , tap **Open Business Card**, then tap the card you want to recognize and add to the contact list.

# media applications

---

## browser



The browser lets you access Web pages and Web-based applications on your phone. Contact your service provider to set up access, if necessary.

### start a browser session

Press the *browser key*  to launch the browser.

If you are unable to establish a network connection with the browser, contact your service provider.



## interact with web pages

Pull down the scroll bar to scroll through a text page or option list. Tap an option to select it. Tap  at any time to return to the previous screen.

Some Web pages may contain text fields for exchanging information with a Web site. Tap the field and enter text in the usual way.

Tap  to perform various browser operations. The browser menu can include the following options:

options	
Go To Page	Enter a Web address (URL) to go to a Web site.

options	
<b>Home</b>	Go to the homepage of the current Browser profile.
<b>Bookmarks</b>	See a list of your bookmarks. Tap  to add a <b>New</b> bookmark, or <b>Open, Edit, Delete,</b> or <b>Share</b> the highlighted bookmark.
<b>History</b>	See a list of Web sites you have visited. Tap  to <b>Open</b> or <b>Delete</b> the highlighted Web site.
<b>File</b>	<b>Save</b> a file or <b>Save All</b> files in the browser window, <b>Copy</b> a file, tap <b>About Opera</b> to see browser information.
<b>View</b>	Set browser view to <b>Fit to Screen</b> or <b>Full Screen</b> , set text size to <b>Small, Medium,</b> or <b>Large</b> , on the Web page, or select a <b>Custom Zoom</b> setting.

options	
<b>Active Pages</b>	Bookmark the active page, show the security level, or change encoding of the active page.
<b>Setup</b>	Add and edit browser profiles, adjust browser preferences, show SSL and WTLS certificates, empty the cache, and delete cookies.

## download files



You can download a file, game, or application from a Web page onto your phone by selecting its link.

You must specify the location where you want to save the file, and your phone must have sufficient memory storage space to store the file.

You can purchase games, applications, and multimedia content for your phone. In most cases, you can download and preview content before you purchase it. After previewing the content, you can choose to discard it, or purchase it and install it on your phone.

### Notes:

- Call charges apply during download sessions.
- Some games might make your phone vibrate. Some ringtones vibrate automatically. If you use one of these tones, your phone vibrates even when it is not set to a vibrate ring style.

## close the browser

Tap **X** to close and exit the browser application.

## network connection profiles





You can use different Internet accounts to connect to the Internet in different ways. Use the network feature to select or create a network connection profile for an Internet account.

### select a profile

To select a network connection profile, tap **X Setup** in the application launcher screen, tap **Data Network**, tap the profile you want to use, then tap **Connect** to connect to the Internet using the selected profile.

## create a new profile

To create a new network connection profile:

- 1 Tap  **Setup** in the application launcher screen, then tap **Data Network**.
- 2 Tap , then tap **New** to open the new profile menu.
- 3 Enter configuration settings as described in the following table. Tap the direct line in a field to enter the setting. Pull down the scroll bar to see additional fields.
- 4 When you're finished entering information, tap **Save** to store the profile.



options 	
<b>Profile Name</b>	Enter the profile name.
<b>GPRS APN</b>	GPRS access point name (the name of the WAP service provider).

options 	
<b>User Name</b>	User name for GPRS APN connection.
<b>Password</b>	Password for GPRS APN connection.
<b>Timeout</b>	Inactivity interval at which the phone disconnects the GPRS connection.
<b>DNS Server 1 and 2</b>	Primary and backup DNS IP servers.
<b>CSD Dial In Number</b>	Phone number to use to set up a CSD connection.
<b>CSD User Name</b>	User name for CSD connection.
<b>CDS Password</b>	Password for CSD connection.

options 	
<b>CSD Baud Rate</b>	Connection speed for CSD connection.
<b>CSD Line Type</b>	Line type (modem or ISDN) for CSD connection.
<b>CSD Timeout</b>	Inactivity interval at which the phone disconnects the CSD connection.
<b>CSD DNS Server 1 and 2</b>	Primary and backup DNS IP servers.

## use browser profiles



To select the active browser profile:

- 1 Tap  **Browser** in the application launcher screen to start the browser.
- 2 Tap , then tap **Setup** to open the browser setup menu.

## 102 media applications

- 3 Tap **Profiles**, then tap the profile you want to use.
- 4 Tap **Save** to save the highlighted profile as the active profile.

To create a new browser profile:

- 1 Tap  **Browser** in the application launcher screen to start the browser.
- 2 Tap , then tap **Setup** to open the browser setup menu.
- 3 Tap **Profiles** to open the profiles menu.
- 4 Tap , then tap **New** to create the profile.

You must set the **Profile Name**, **Primary Gateway IP** and **Port** number, **Secondary Gateway IP** and **Port** number, **Homepage**, and the **Network Link** (the network connection profile you want to use) for a browser profile.



To edit an existing browser profile, select it, tap , tap **Setup**, then tap **Edit** to change the settings described above.

## RealOne media player

Your phone has a RealOne media player that you can use to play audio and video files.

Tap  **Media Player** in the application launcher screen to launch the media player.

When you see the prompt **Refresh "My Library" Now?**, tap **Refresh** to add any new media files located on the phone or memory card to your library list.







### play media files

**1** Tap **All Audio**, **All Videos**, or another media category to see which files of that type are available on your phone.



- 2** Tap the check box  beside each file you want to play. A check mark  indicates that the file is selected.
- 3** Tap **Play Selected** to begin playing the selected file(s).

**Shortcut:** Tap a specific file name to play the file.

In the media player window:

- Tap  or  to pause or play a file or playlist.
- Tap  or  to play the previous or next file.
- Tap and hold  or  to rewind or fast forward through a file.



- Tap  to adjust or mute sound volume. Tap the volume slider to adjust the volume. (Alternatively, you can press the side volume keys to adjust volume.) Tap  on the slider bar to mute and unmute the sound

**Tip:** You also can use the side media player keys (see illustration on page 2) to control playback of media files.

## create and use playlists

To **create** a new playlist:

- 1 Select media files as described in the previous section.
- 2 Tap , then tap **Save as Playlist** to create a new playlist with the selected files.
- 3 Enter a name for the playlist, then tap **Save** to save the new playlist.

To **play** a playlist:

- 1 Tap  **Media Player** in the application launcher screen to launch the media player.
- 2 Tap **My Playlists** to see the playlists stored on your phone.
- 3 Tap a playlist to select it and see the list of files in the playlist.
- 4 Tap a file in the playlist to begin playing it.

Your phone plays the playlist files in sequence.

## playlist options

Tap  to perform various operations on a selected or active playlist. The playlist menu can include the following options:

options	
<b>Edit</b>	Edit the name or contents of a playlist.
<b>Shuffle</b>	Shuffle the order in which the playlist files are played.
<b>Repeat</b>	Replay the playlist when the last file finishes playing.
<b>Delete</b>	Delete stored playlists.  Deleting a playlist does <b>not</b> delete the media files stored on your phone.

### options

<b>Use Bluetooth</b>	Use a Bluetooth™ wireless connection to send the selected media file to another phone, PC, or hand-held device.
----------------------	---

## camera

Your phone has a 2 megapixel camera that can take photos at up to 1200 x 1600 pixels resolution. The camera includes a macro mode for taking close-up photos.

Press the camera key (see illustration on page 2) to activate the camera. The active viewfinder image appears in the display.

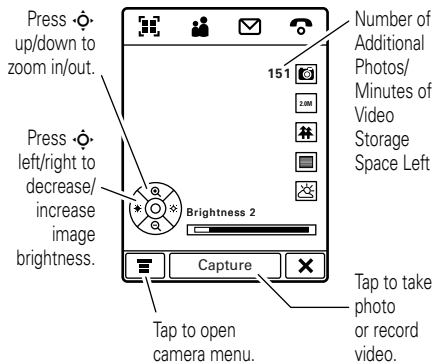

## use the viewfinder

Press  $\odot$  or the side up/down keys to zoom in/out. Press  $\odot$  left/right to adjust image brightness.



**Tip:** Tap the viewfinder screen to remove the indicators for an unobstructed fullscreen view. Tap the fullscreen view to return the indicators.

The viewfinder indicators are active and can be used to change the most-used functions (such as image size, camera/video mode, and effects mode).

The number next to the photo/video mode indicator represents the number of additional photos, or the minutes and seconds of additional video, that can be stored in the current selected memory storage location.

## take a photo

Press the camera key, tap **Capture**, or press the center key  to take a photo.

**Tip:** If the camera is in video mode, tap  to put the camera in photo mode. The mode indicator in the viewfinder changes to  to show that the camera is in photo mode.

## set normal or macro mode

Slide the camera mode switch **up** to take standard pictures. Slide the camera mode switch **down** to set macro mode when you want to take close-up photos of small objects or details, or capture a business card image with the **BC Reader** application.

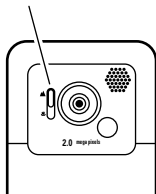

**Camera Mode Switch**  
Up = normal picture mode.  
Down = macro mode.





## change photo storage location



Photos and video clips can require large amounts of storage space. To avoid using up the limited phone memory space, you can save your photos and video clips to an optional removable SD memory card or MMC memory card. To insert a memory card in your phone, see page 21.

- 1 Tap , tap **Setup**, then tap  to open the photo setup menu.
- 2 Tap the folder tree icon  in the **Save To** field.
- 3 Select the folder on the memory card that you want to use, or tap **New** to create a new folder on the memory card.
- 4 Tap **OK** to set the folder as the new storage location.
- 5 Tap **Save** to save the new storage location.

## record a video clip

Tap  to put the camera in video mode. The mode indicator in the viewfinder changes to  to show that the phone is in video mode.

Tap **Record** to start recording a video clip.  
Tap **Done** to stop video recording.

**Note:** Your phone can record about five hours of video, with a fully-charged battery and enough available space on the memory card.



## view and delete photos or video clips

To **view** a photo or video clip:

- 1 Tap , then tap **Album** to open the folder where your photos or video clips are stored.

- 2 Tap a photo thumbnail image to see the photo. Tap  on a video clip thumbnail image to play the video clip.

To **delete** photos or video clips:



- 1 Tap , then tap **Album** to open the folder where your photos or video clips are stored.
- 2 Tap , then tap **Delete**.
- 3 Tap the check box  beside each photo or video clip you want to delete, or tap the check box beside **All** to select all items. A check mark  indicates that the item is selected.
- 4 Tap **OK** to delete the selected photo(s) or video clip(s).

**Tip:** To quickly delete a single photo or video clip, tap and hold the thumbnail image to open a pop-up menu, then select **Delete**.

## effects

You can adjust the **size** of your photo or video by tapping the appropriate icon in the viewfinder. Tap other icons to set **lighting** conditions or select a photo **style** (such as **Black/White** or **Sepia** tones).

## setup options

Tap , tap **Setup**, then tap  to open the photo setup menu.

You can set or adjust the following options:

options	
<b>Photo Size</b>	Set photo size.
<b>Photo Quality</b>	Set photo quality.
<b>Default Name</b>	Apply a date and time stamp, or specify a text prefix for the photos and videos you take.

options	
<b>Shutter Sound</b>	Set the shutter sound.
<b>Save To</b>	Specify the location (phone memory or memory card) where your photos/video clips are saved.

## delay timer

Tap , then tap **Delay Timer** to activate the delay timer. The timer indicator appears in the upper-right corner of the viewfinder.

Tap **Start** to activate the timer. The timer counts down from 10 seconds, and then takes a photo. You can tap **Stop** to stop the timer at any time during the countdown.

**Tip:** To take a self-portrait, activate the timer, and use the mirror to aim the camera lens.

# voice recorder

You can record personal messages and phone calls on your phone.



**Note:** Recording of phone calls is subject to varying State and Federal laws regarding privacy and recording of phone conversations. Always obey the laws and regulations on the use of this feature.

## make a recording

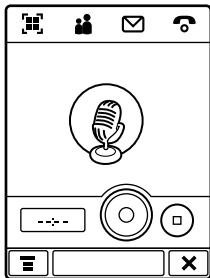

Tap  **Recorder** in the application launcher screen to activate the voice recorder.

- 1 Tap  to start recording.
- 2 Speak into the phone.



- 3 Tap  to stop recording. The voice record is automatically saved to the **MyAudio** folder on your phone.
- 4 To play back the voice record you just made, tap . To stop playback, tap .



## play a recording

- 1 Tap  **Recorder** in the application launcher screen to activate the voice recorder.
- 2 Tap , then tap **Open** to open the **MyAudio** folder.
- 3 Tap the voice record you want to play, then tap **Open** to play it.

**Tip:** The voice record name identifies the date and time when the file was recorded. The recording date and time also appears when you play the voice record.



## change voice record storage location

- 1 Tap , tap **Setup**, then tap the folder tree icon  in the **Location** field.
- 2 Select a folder, then tap **OK** to set it as the new storage location.
- 3 Tap **Save** to save the new storage location.

## video camera

To activate the camera in video mode, tap  **Video Camera** in the application launcher screen.

For instructions on how to use the camera in video mode, see page 105.

**Note:** Your phone can record about five hours of video, with a fully-charged battery and enough available space on the memory card.

## photo editor

Use the photo editor to edit photos and images stored on your phone, or create new drawings or illustrations.

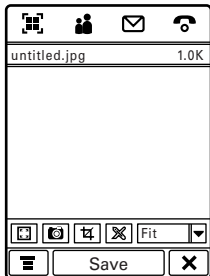

Tap  **Photo Editor** in the application launcher screen to open the photo editor.

To **edit** an existing photo or picture, tap , tap **Open**, then select the picture you want to open.



Tap a button in the toolbar at the bottom of the screen to perform the following operations on the picture:

- Tap  to see a full-screen picture view. Tap the full-screen view to return to the photo editor screen.

- Tap  to activate the camera, take a photo, and open it in the photo editor.
- Tap  to crop a portion of the photo. Tap and drag the bounding box to outline the crop borders. Tap and drag a bounding box edge or corner to resize the bounding box.
- Tap  to use the drawing tools on the picture as described below.

To **draw** a new picture, or use the drawing tools on an existing photo or picture, tap the drawing button  in the toolbar at the bottom of the screen, then:

- Tap a drawing tool in the bottom left corner of the screen.
- Tap the box to the right of the drawing tool to adjust tool settings.

- Tap the color picker to the right of the tool settings box to set a drawing color.
- Tap the scaling drop-down menu to zoom in/out on the picture, or tap **Fit** to fit the picture to the page.

To **save** a picture:

- 1 Tap **Save**.
- 2 Enter a name, storage location, and picture type.
- 3 Tap **Save** to save the picture.

Tap  to perform the following operations:

options	
<b>Undo or Redo</b>	Undo or redo the last editing or drawing operation.
<b>New</b>	Open a blank canvas to create a new picture.

options	
<b>Open</b>	Open an existing photo or picture.
<b>Save As</b>	Specify a name for a picture you save.
<b>Share</b>	Send the picture over a Bluetooth wireless connection, or in an MMS or email message.
<b>Overlay</b>	Apply a border, image, text, or timestamp to the picture.
<b>Rotate</b>	Rotate or flip a picture.
<b>Adjusting</b>	Adjust picture size, brightness, contrast, sharpness, or color.
<b>More</b>	Apply filters, change picture style, or print the picture.



## FM radio



You can use your phone to listen to FM radio stations when an optional Motorola Original™ standard headset or stereo headset is plugged into the phone's headset jack. 

**Note:** You can't listen to the FM radio over a Bluetooth wireless headset.

Tap  **FM Radio** in the application launcher screen to turn on the radio.

### tune a station



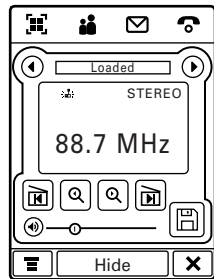

Tap  or  to step down or up to the next preset setting.

Tap  or  to search and set the previous or next active FM station.





## use preset channels

Tap  to assign a channel number to the current tuned station.

Tap  or  to select the previous or next assigned channel. Alternatively, you can press the  or  media player keys (see illustration on page 2) to select the previous or next channel.

## radio controls

Tap the volume slider to adjust the radio volume. Alternatively, you can press the side key  buttons to adjust radio volume.

Tap  to mute the radio. Alternatively, you can press the  media player key (see illustration on page 2) to mute/unmute the radio.

Tap **Hide** to hide the radio when you want to use the display for other applications. The radio continues to play.

Tap  to edit radio channels, play the radio through your phone's internal speaker, or set the radio to play mono or stereo sound.

**Tip:** You also can use the side media player keys (see illustration on page 2) to control some radio functions.

## send/receive calls with the radio on

Your phone rings or vibrates as usual to notify you of an incoming call, message, or other event. You can answer the call, or ignore the call and continue listening to the radio.

If you answer the call, tap **End** as usual to end the call and resume the FM broadcast.

You don't have to turn off the radio to make a call. The radio is muted automatically when you dial an outgoing call from the phone keypad.

# extra applications

---

## talking phone

You can set your phone to recite the names of menu features as you select them, read entries in your contacts list, recite phone numbers as you enter them, and/or read messages you receive.

- 1 Tap  **Setup** in the application launcher screen, then tap **Talking Phone**.
- 2 Tap the check box  beside a talking phone feature (**Menu readout**, **Contact List readout**, **Digits readout**, or **Message readout**) to select it. A check mark  indicates that the feature is activated.
- 3 Tap **Save** to save your setting.

## Bluetooth™ wireless

Your phone supports Bluetooth wireless connections. You can connect your phone with a Bluetooth headset or car kit to make handsfree calls. You can connect your phone with a phone or computer that supports Bluetooth connections to exchange files.

**Tip:** Your phone's antenna must be on to use Bluetooth features.

**Note:** The use of wireless phones while driving may cause distraction. Discontinue a call if you can't concentrate on driving. Additionally, the use of wireless devices and their accessories may be prohibited or



restricted in certain areas. Always obey the laws and regulations on the use of these products.

**For maximum Bluetooth security,** you should always pair Bluetooth devices in a safe, private environment.

## turn Bluetooth power on or off

**Shortcut:** Tap the status bar at the top of the display, then tap the **Bluetooth** drop-down menu to turn Bluetooth power **On** or **Off**.

To activate or deactivate Bluetooth power from the application launcher:

- 1 Tap  **Bluetooth** in the application launcher screen, then tap .
- 2 Tap **Turn On** or **Turn Off** to activate or deactivate Bluetooth power.

**Note:** To extend battery life, set Bluetooth power to **Off** when not in use. Your phone will not connect to another device until you set Bluetooth power back to **On** and connect your phone to the device again.

## use a headset or handsfree car kit

**Before you try to connect your phone to a handsfree device,** make sure the device is **on** and **ready** in *pairing* or *bonding* mode (see the user's guide for the device). You can pair your phone with only one device at a time.

- 1 Tap  **Bluetooth** in the application launcher screen to see the device list.
- 2 If necessary, turn Bluetooth power on.
- 3 Tap **Search** to search for Bluetooth devices.

Your phone lists the devices it finds within range.

To connect to a device, select it from the list and tap **Bond**. Your phone automatically uses **0000** as the passkey to bond with the device. If **0000** doesn't work, your phone prompts you to enter the device's passkey.

**Shortcut:** When Bluetooth power is on, your phone can automatically connect to a handsfree device you have used before. Just turn on the device and move it near the phone.

## copy files to another device

You can copy a photo, picture, video clip, sound file, contact, calendar event, or bookmark to another phone or computer that supports Bluetooth connections.

**Note:** You can't copy some copyrighted objects.

**Before you try to copy a file to another device**, make sure the receiving device is **on** and **ready** in discoverable mode.

- 1 Tap and hold the object to open a pop-up menu, then select **Share** to see a list of share options.
- 2 Tap **Bluetooth** to see the device list.
- 3 Tap the device name on the list, or tap **Search** to locate the device.
- 4 Tap **Send** to send the object. If necessary, enter the correct PIN code to create a secure connection with the device.

**Note:** Once you connect your phone to a Bluetooth device, that device can start a similar Bluetooth connection with your phone. Your display shows when a Bluetooth connection is active.





## receive files from another device

**Before you try to receive a file from another device**, make sure your phone's Bluetooth power is **on** (see page 117).

- 1 Send the file from the device.

If your phone and the sending device don't recognize each other, place your phone in discoverable mode so the sending device can locate it.

Tap  **Bluetooth** in the application launcher screen, tap , then tap **Discoverable**.

- 2 The device may request permission to bond with your phone. If necessary, enter the correct PIN code to create a secure connection with the device.

## send a photo to a printer

You can send a photo to a printer that supports Bluetooth connections.

**Note:** You can print A4 or US Letter size pages. To print another size, copy the object to a linked computer and print it from there.

- 1 On your phone, take a new photo or scroll to a stored photo that you want to print, tap , then tap **Print**.
- 2 If available, choose additional objects or print options.
- 3 Select a recognized printer name, or tap **Search** to search for an unrecognized printer where you want to send the object.

## advanced Bluetooth features

**Note:** A device is *recognized* after you connect to it once (see page 117).

### features

#### pair with recognized device

Tap  **Bluetooth** in the application launcher screen to see device list, tap and hold the device name to open a pop-up menu from which you can choose to **Create Bond**, **Connect**, **Delete**, or **Lock/Unlock** the device.

#### drop pairing with device

Tap  **Bluetooth** in the application launcher screen to see device list, tap and hold the device name to open a pop-up menu, select **Disconnect** the drop the connection.

## synchronize phone information

You can synchronize data between your phone and a PC through a Bluetooth wireless connection or USB cable connection using Motorola mobile PhoneTools software

To transfer and synchronize data between your phone and PC, you must use the Motorola mobile PhoneTools software included with the Motorola Original data kit. See the mobile PhoneTools user's guide for more information.



Motorola mobile PhoneTools software is designed to synchronize with basic features of many popular Personal Information Management (PIM) software and hardware products.

You can connect your phone and PC using a Bluetooth wireless connection (see page 116), or a Motorola Original USB cable connected to your phone and PC.



Once the phone is connected to the PC, select the “Sync” option from the Motorola mobile PhoneTools software running on the PC.

## modem



You can use your phone as a modem, to connect your PC to the Internet or transfer data to/from the PC. To use the phone as a modem, you must connect it to the PC using a Bluetooth wireless connection or USB cable connection.

**Tip:** To connect your phone to the PC through a Bluetooth connection, make sure that your

PC supports Bluetooth and has the correct drivers installed.

Motorola mobile PhoneTools software includes a PC modem application that makes it easy to use your phone as a modem, and to set up a USB cable connection without first having to activate your phone’s modem application.



When you connect your phone and PC over a USB cable connection, make sure that the phone is set to the correct USB mode setting. Tap  **Setup** in the application launcher screen, tap **USB Mode**, select **Modem**, then tap **Save**.

Tap  **Modem** in the application launcher screen to see the modem status screen. When your phone shows **Status: Ready**, it’s ready to be used as a standard PC modem.

## send data call



- 1 Open the application (such as dial-up-networking) on your PC, and place the call through the application.

You cannot dial data numbers on your phone's keypad. You must dial them through the PC.

- 2 When data transfer is complete, end the call from the connected PC to close the connection.

## receive data call



- 1 Your phone notifies you when the data call arrives, and transfers the call to the connected PC. Use the application running on the PC to answer the call.
- 2 When the data transfer is complete, end the call from the connected PC to close the connection.

## STK



Your SIM card may contain additional SIM Toolkit (STK) applications that add features and functionality to your phone.

Tap  **STK** on the application launcher screen to see a list of STK applications you can use.

Tap a service or feature to select it.

Your phone shows the service or feature screen.

Pull down the scroll bar to scroll through a text page or option list. Tap an option to select it. Tap  at any time to return to the previous screen.

Some screens may contain text fields where you must provide information in order to use a service or feature. Tap the field and enter text in the usual way.

For more information about the STK applications available on your SIM card, contact your service provider.

## world time

Your phone can show the current time and date for multiple cities around the world.

Tap  **World Time** in the application launcher screen to see the world time screen.

You can reset the time and date for a listed city. Tap the time and/or date field to change it. Tap **OK** to save your changes.

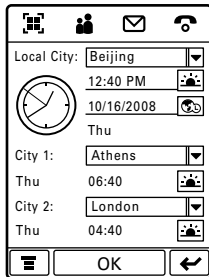

To replace a city listing in the world time screen, tap the city name, then tap **Browse...** to see the time zone map (shown at right). Tap the city name again to see a city list. Select a new city, then tap **OK** to store it.









Alternatively, tap a time zone in the time zone map to see a list of cities in that time zone. Select a new city, then tap **OK** to store it.

# other features

---

## advanced calling

features	
<b>conference call</b>	
During a call:	
Tap keypad button  , tap keypad keys to dial next number, tap <b>Call</b> , when call connects tap <b>Link</b> to connect the two calls. Repeat to add additional parties to the call.	
<b>transfer a call</b>	
During a call:	
Tap  , tap <b>Transfer</b> , tap keypad keys to dial the number to which you want to transfer the call, tap <b>Call</b> to transfer.	

features	
<b>call forwarding</b>	
Set up or cancel call forwarding:	
Tap  , tap  , tap <b>Setup</b> , tap <b>Call Divert</b> .	
Tap ( <b>Voice Calls</b> , <b>Data Calls</b> , or <b>Fax Calls</b> to select the type of calls you want to forward.	
Tap <b>Cancel All Diverts</b> to cancel all call forwarding.	
<b>call barring</b>	
Restrict outgoing or incoming calls:	
Tap  , tap  <b>Setup</b> , tap <b>Security</b> tap <b>Call Barring</b> .	

## features

### fixed dial



When you turn on fixed dialing, you can call only numbers stored in the fixed dial list.

Tap , tap  **Setup**, tap **Security**, tap **Fixed Dialing**, then select **On** or **Off**.

You edit fixed dial entries just like an address book contact. You can enter a wildcard character ^ in one or more positions for a fixed dial phone number. The wildcard character can be replaced by any digit when the user dials the number.

## setup

### features

#### language

Set menu language:

Tap , tap  **Setup**, tap **Language**.

**Tip:** Select **Automatic** to let your phone set the language based on your location.

#### text size

Set the size of the display text:

Tap , tap  **Setup**, tap **Text Size**.

## features

### USB mode

Set the mode in which you want to use your phone's USB port:

Tap , tap  **Setup**, tap **USB Mode**, then select **Modem**, **Mass Storage**, or **Web Camera**.

In **Web Camera** mode, you can use your phone as a PC camera when you connect the phone to a PC through a USB cable connection. Use the CD-ROM included with your phone to install the Web camera device driver on the PC.

**Note:** Motorola mobile PhoneTools software can automatically change your phone's USB mode setting as needed.

## features

### touch-screen calibration

Calibrate the touch-screen if the phone begins to respond incorrectly to your stylus input on the touch-screen display:

Tap , tap  **Setup**, tap **Screen Calibration**.

### power management

Your phone includes several features designed to help extend battery life.

**Tip:** To conserve power, leave Bluetooth™ power turned off when not in use.

Tap , tap  **Setup**, then tap **Power Management**.

Select **Battery Save** to automatically adjust phone settings to maximize battery life.

Select **Auto Power Off** to have your phone automatically turn itself off after a specified period of inactivity.



## features

### master reset

Reset all default phone settings **except** for the lifetime timer:

Tap , tap  **Setup**, tap **Master Reset**.

**Tip:** Tap **Cancel** to exit without performing the master reset procedure.

## features

### master clear

**Caution:** Master clear **erases all information you have entered** (including address book and calendar entries) **and content you have downloaded** (including photos and sounds) stored in your phone's memory. After you erase the information, you can't recover it.

Clear all settings and entries you made **except** SIM card information, erase downloaded pictures and sound files, and reset all options **except** for the lifetime timer:

Tap , tap  **Setup**, tap **Master Clear**.

**Tip:** Tap **Cancel** to exit without performing the master clear procedure.

## call times & costs



**Network connection time** is the elapsed time from the moment you connect to your service provider's network to the moment you end the call by pressing  or tapping **End**. This time includes busy signals and ringing.

**The amount of network connection time you track on your resettable timer may not equal the amount of time for which you are billed by your service provider. For billing information, contact your service provider.**

### features

#### call times



See call timers and cost trackers:

Tap , tap , tap **Setup**, tap **Call Meters**.



To reset the call timer, tap **Clear Call Time**.

To reset the cost tracker, tap **Clear Call Cost**.

#### in-call timer



Show time or cost information during a call:

Tap , tap , tap **Setup**, tap **Call Meters**, tap the **Display** pop-up menu, then select **Timer**, **Cost**, **Total Cost**, **Credit**, or **Off**.

## features

### audible in-call timer





Set an audible timer to beep at specified intervals during a call:

Tap , tap , tap **Setup**, tap **Call Meters**, tap the **Audible Timer** pop-up menu, then select **Off**, **1 Min**, **5 Min**, **10 Min**, or **15 Min**.

### call cost setup



Set a credit limit:

Tap , tap , tap **Setup**, tap **Call Meters**, tap **Call Cost Setup**, enter your SIM PIN2 code when prompted.



You can enter a credit limit, and set the phone to show your remaining credit in time units or as a currency value.

## features

**credit available** (advice of charge option)



See the amount of credit available:

Tap , tap , tap **Setup**, tap **Call Meters**, tap **Available Credit**.

## handsfree

**Note:** The use of wireless phones while driving may cause distraction. Discontinue a call if you can't concentrate on driving. Additionally, the use of wireless devices and their accessories may be prohibited or restricted in certain areas. Always obey the laws and regulations on the use of these products.

## features

### adjust Bluetooth™ accessory volume

If your Bluetooth headset or car kit accessory supports remote volume control, you can use your phone's side up/down keys to set the device's speaker volume during a handsfree call.

### auto answer

Automatically answer calls when using the handsfree speaker, or when the phone is connected to a car kit, headset, or external speakerphone:

Tap  to open the phone keypad, tap , tap **Setup**, then select **Auto Answer**.

## security

## features

### lock/unlock SIM card

Your *Personal Identification Number* (PIN) code protects the information stored on your SIM card. When the SIM card is locked, you must enter your SIM card PIN code to unlock the SIM card each time you turn on the phone or insert the SIM card in the phone. Your SIM card PIN code is given to you by your service provider.

**Caution:** If you enter an incorrect PIN code three times in a row, your SIM card is disabled and your display shows **SIM Blocked**.

Tap  to open application launcher, tap  **Setup**, tap **Security**, then select **PIN Request On** or **PIN Request Off**.

## features

### unlock SIM card PIN codes



If you enter an incorrect SIM card PIN code or PIN2 code three times in a row, your SIM card is disabled and your phone shows **SIM PIN Blocked**. You must enter a PIN unblocking key (PUK) code, which you can obtain from your service provider.

**Caution:** If the unblocking attempt is tried unsuccessfully 10 times, the SIM card is permanently disabled and your phone shows **SIM Disabled**.

# Specific Absorption Rate Data

---

## This model meets international guidelines for exposure to radio waves.

Your mobile device is a radio transmitter and receiver. It is designed not to exceed the limits for exposure to radio waves recommended by international guidelines. These guidelines were developed by the independent scientific organization ICNIRP and include safety margins designed to assure the protection of all persons, regardless of age and health.

The guidelines use a unit of measurement known as the Specific Absorption Rate, or SAR. The ICNIRP SAR limit for mobile devices used by the general public is 2 W/kg and the highest SAR value for this device when tested at the ear was 0.71 W/kg.<sup>1</sup> As mobile devices offer a range of functions, they can be used in other positions, such as on the body as described in this user guide.<sup>2</sup> In this case, the highest tested SAR value is 0.89 W/kg.<sup>1</sup>

As SAR is measured utilizing the device's highest transmitting power, the actual SAR of this device while operating is typically below that indicated above. This is due to automatic changes to the power level of the device to ensure it only uses the minimum level required to reach the network.

While there may be differences between the SAR levels of various phones and at various positions, they all meet the governmental

requirements for safe exposure. Please note that improvements to this product model could cause differences in the SAR value for later products; in all cases, products are designed to be within the guidelines.

The World Health Organization has stated that present scientific information does not indicate the need for any special precautions for the use of mobile devices. They note that if you want to reduce your exposure then you can do so by limiting the length of calls or using a "hands-free" device to keep the mobile phone away from the head and body.

Additional Information can be found on the websites of the World Health Organization (<http://www.who.int/emf>) or Motorola, Inc. (<http://www.motorola.com/rfhealth>).

1. The tests are carried out in accordance with international guidelines for testing. The limit incorporates a substantial margin for safety to give additional protection for the public and to account for any variations in measurements. Additional related information includes the Motorola testing protocol, assessment procedure, and measurement uncertainty range for this product.
2. Please see the *Safety and General Information* section about body worn operation.

# Information from the World Health Organization

---

Present scientific information does not indicate the need for any special precautions for the use of mobile phones. If you are concerned, you may want to limit your own or your children's RF exposure by limiting the length of calls or by using handsfree devices to keep mobile phones away from your head and body.

Source: WHO Fact Sheet 193

Further information: <http://www.who.int./peh-emf>

# GNU General Public License

---

For instructions on how to obtain a copy of any source code being made publicly available by Motorola related to software used in this Motorola mobile device, which may be subject to GNU's General Public License, please send an email to [ezxgpl@motorola.com](mailto:ezxgpl@motorola.com).



# index

---

## A

- accessories 16, 116, 129
- address book 47
- airplane mode 22
- alarm clock 90
- alert
  - set 38
  - turn off 32
- answer a call 23
- antenna, turning on/off 22
- application launcher 26
- appointments. See calendar

## B

- battery 18, 19
- battery charge indicator
  - light 19

- battery indicator 29
- battery life,
  - extend 20, 117, 126
- Bluetooth indicator 29
- Bluetooth wireless 116
- bonding. See Bluetooth wireless
- brightness, set 40
- browser 98
- browser key 1, 98
- browser messages 72
- business card reader 95
- button bar 28

## C

- calculator 89
- calendar 82

## call

- answer 23
- cancel 44
- end 23, 24
- make 23
- call barring 34, 124
- call forwarding 124
- call timers 128, 129
- call waiting 43
- caller ID 43
- camera 3, 105
- camera key 1, 2, 3
- camera mode switch 3
- car kit 129
- center key 1, 33
- clock 29
- codes 34

color scheme 39  
conference call 124  
costs, track 129  
credit information 129

## D

data, sharing 36  
dial a phone number 23, 125  
dialed calls 41  
direct dial 46  
display 25, 39, 40

## E

earpiece 1  
earpiece volume 33  
email 75  
email address 48  
emergency number 44  
end a call 23, 24  
end key 1  
English keyboard 31

**136** index

Enter Unlock Code  
message 34  
extension number,  
dialing 46

## F

file manager 91  
fixed dial 125  
FM radio 113  
FM radio key 1, 113  
forward calls 124  
function buttons 31

## G

global navigation bar 26  
GPRS indicator 28

## H

handsfree speakerphone 33  
handwriting 32

headset 129  
headset jack 1  
hold a call 43  
home screen 25

## I

Incoming Call message 43  
incoming call, cancel 44  
information service  
messages 73  
information, sharing 36  
input settings 32  
international access code 45

## L

language 125  
linking. See Bluetooth  
wireless  
lock  
phone 34  
phone keys 35

- SIM card 130
- touch-screen 35
- Low Battery message 29

## **M**

- make a call 23
- master clear 127
- master reset 127
- media player 103
- media player indicator 29
- media player keys 2
- memory card 21
- memory card indicator 29
- memory card slot 1, 2
- Memory is Full! message 65
- message
  - outbox 63
  - reading 64
  - sending 59, 60
  - signature 58
  - status 63

- micro-browser 72
- mini-USB port 1, 2
- modem 121
- multimedia message 60
- mute a call 43

## **N**

- navigation key 1, 33
- notes 88
- numeric pad 31

## **O**

- objects, sharing 36
- optional accessory 16
- optional feature 16
- organizing files 91
- outbox 63

## **P**

- pairing. See Bluetooth
  - wireless
- password 34
- phone lock switch 1, 2
- phone number
  - storing 48
  - your number 24
- photo 105
- photo editor 111
- picture ID 43
- PIN code 22, 34, 130, 131
- PIN2 code 34
- Pinyin keyboard 30
- power key 1, 22
- power management 126
- printing 119
- profiles 38

## **Q**

- quick card 62, 65

## R

- radio 113
- RealOne indicator 29
- RealOne media player 103
- received calls 41
- recent calls 41
- recorder 110, 111
- redial 42
- ring alert profiles 38
- ringer ID 43
- ringer volume 39
- ringtone 38, 49, 53

## S

- safety information 8
- security code 34
- send key 1, 23
- setup 125
- side up/down keys 1, 2, 32
- signal strength indicator 28
- silent profile 38

**138** index

- SIM Blocked
  - message 22, 130
- SIM card 16, 22, 34, 122, 130, 131
- SIM Disabled message 131
- SIM PIN code 130, 131
- SIM toolkit 122
- speakerphone 33, 129
- status bar 28
- STK 122
- store phone numbers 48
- store your phone number 24
- stylus 3, 25
- synchronize information 120

## T

- talking phone 116
- tap & hold 32
- tasks 87
- text entry 29
- text messaging 59

- text size 125
- time 123
- timers 128, 129
- touch-screen
  - calibrate 126
  - input settings 32
- transfer a call 124
- TTY indicator 29
- turbo dial 45
- turn on/off 22

## U

- unlock the SIM card 131
- unlock
  - phone 22, 34
  - phone keys 35
  - SIM card 130
  - touch-screen 35
- unlock code 34
- USB mode, set 126

## **V**

vibrate profile 38  
video clip 105  
viewer 88  
voice records 110, 111  
voicemail 24, 46  
volume 32

## **W**

wallpaper 39  
Web pages 98  
world time 123

## **Y**

your phone number 24

## **Z**

Zhuyin keyboard 31





[www.hellomoto.com](http://www.hellomoto.com)



MOTOROLA and the Stylized M Logo are registered in the US Patent & Trademark office.  
All other products or service names are the property of their respective owners.  
The Bluetooth trademarks are owned by their proprietor and used by Motorola, Inc. under license.  
© Motorola, Inc. 2006

Specifications are subject to change without notice

**Part No: 6802925J30**