

# Operating Instructions

## ROOM AIR CONDITIONERS

MODELS: CW-1703SR, CW-1773SR

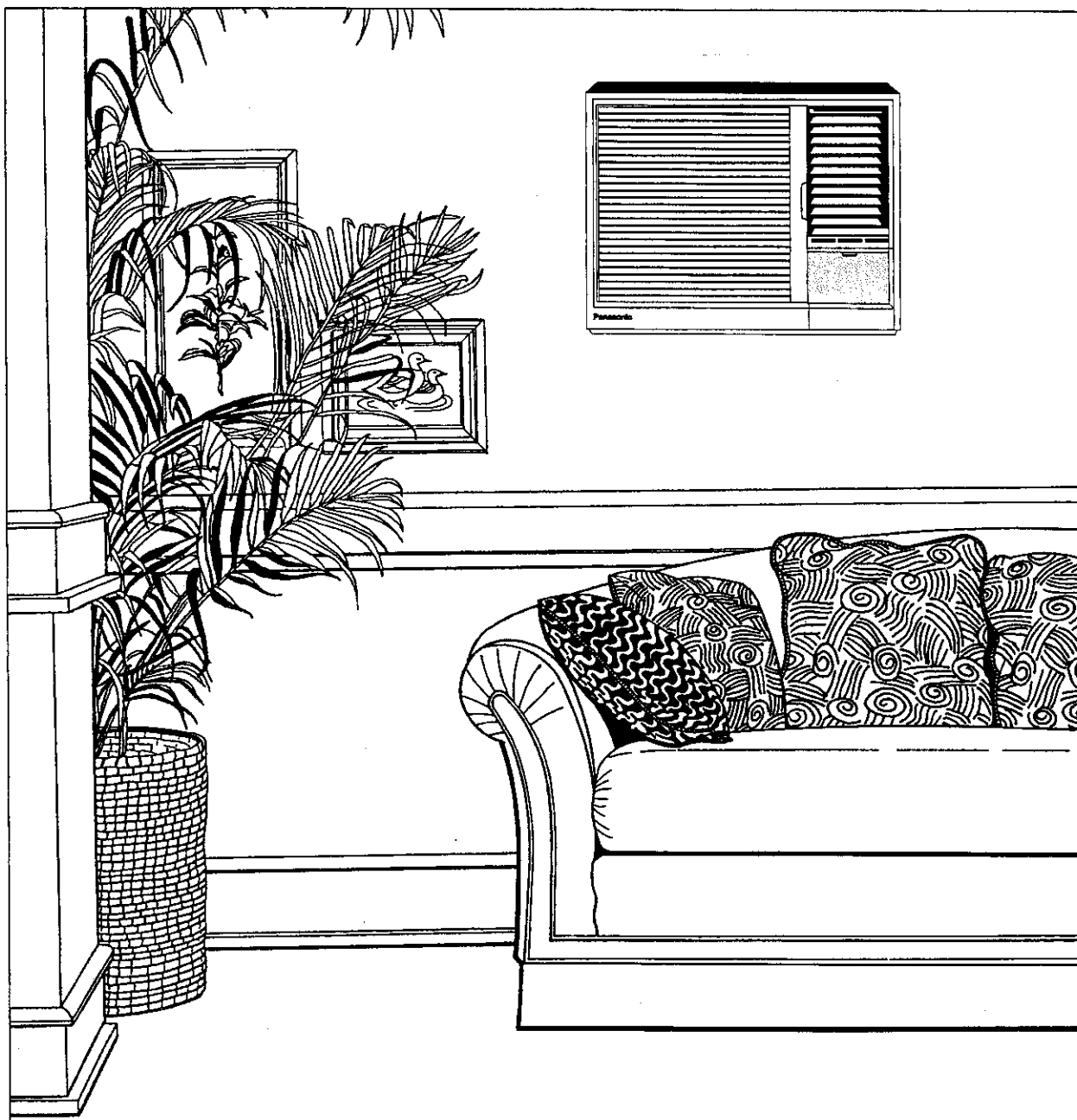

When you're looking for comfort and convenience in a room air conditioner, look to

**Panasonic**

Before using your air conditioner, please read this operating instructions carefully and keep it for future reference.

# Operating Instructions

## Room Air Conditioners

### [CONTENTS]

#### CW-1703SR (Cooling Only)

Product Component Identification .....	2
Air Conditioner Operation .....	3

#### CW-1773SR (Cooling And Heating)

Product Component Identification .....	4
Air Conditioner Operation .....	5
Operation Tips .....	6
Caution .....	7
Care And Maintenance .....	8
Installation .....	9 ~ 10
Before Calling The Serviceman .....	11 ~ 12

# Product Component Identification

CW-1703SR

## Vertical Airflow Direction Vane (Airflow direction adjustment Up-and-Down)

The vertical airflow direction vane is controlled by positioning the vane to discharge the air upwards, downwards or straight out.

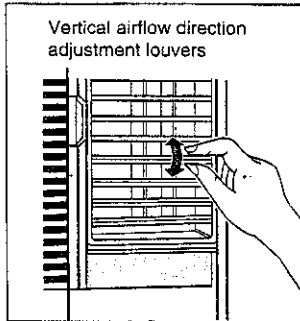

## Ventilation Lever

When the slide lever is at the:

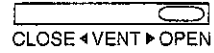

“OPEN” position, the vent. door opens to allow air, smoke or odours to be expelled from the room.



“CLOSE” position, the vent. door is closed and the air inside the room is circulated and conditioned.

Air intake grille

Air filter

Air outlet grille

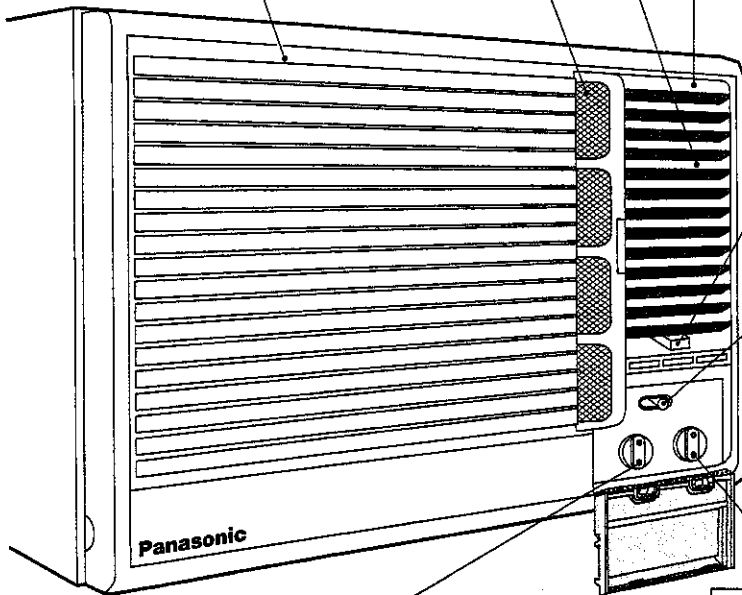

## Air Swing Switch

AIR SWING



**OFF**  
Stops the operation of Air Swing.

**ON**  
Air Swing is in operation.

Power supply cord

## Thermostat Control Knob

When you turn the Thermostat Control Knob to the desired setting, the thermostat will automatically control the temperature of the indoor air. The further clockwise you turn the knob, the cooler the indoor air will become.

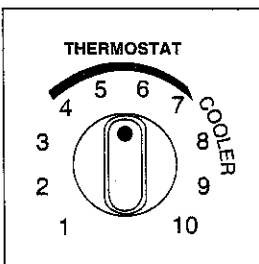

## Main Control Knob

**OFF**  
Stops all operations.

**LOW FAN**  
Fan only operation without cooling at low fan speed.

**HIGH FAN**  
Fan only operation without cooling at high fan speed. (fan only operation recirculates filtered room air).

**LOW COOL**  
Cooling operation at low fan speed.

**HIGH COOL**  
Cooling operation at high fan speed.

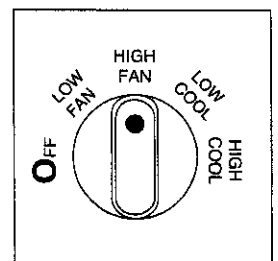

# Air Conditioner Operation

CW-1703SR (Cooling Only)

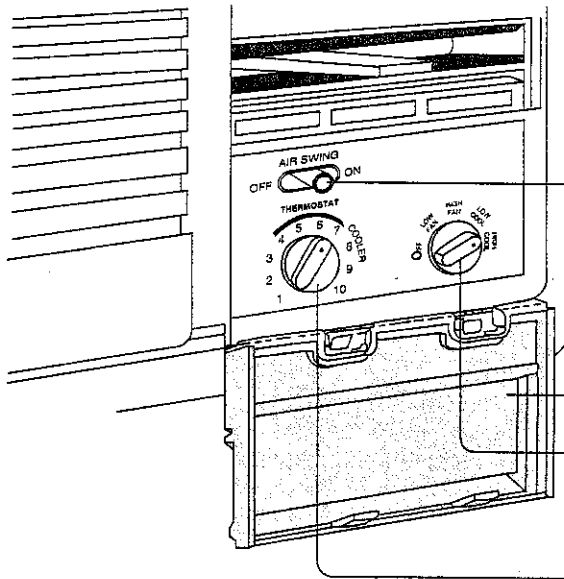

## 1. Power Supply

Set the Main Control Knob to the OFF position; confirm that the Power Supply Cord is connected to a proper AC outlet.

Recommended

Use the air conditioner under the following conditions:

- When humidity does not exceed 90% and room temperature is above 21°C.

Continuous operation at over 90% humidity may create condensation and waterdrops on the intake and outlet vents.

## 2. Open the cover.

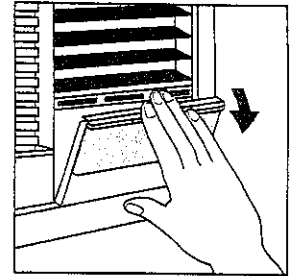

## 3. Main Control Knob

Set to either LOW COOL or HIGH COOL as required. (FAN setting operates the fan only.)

\* Caution: If the Main Control Knob is turned off or changed to a fan setting from a cooling operation setting, WAIT at least 3 minutes before resetting to a cooling operation.

## 4. Thermostat Control Knob

Set the Thermostat Control Knob at the desired setting. (Usually "6 ~ 7" is a recommended setting position.) If the room temperature is unsatisfactory after a reasonable amount of time, turn the control knob clockwise to cool the room more. Or anti-clockwise to cool the room less.

- When the Thermostat Control Knob is set to "10", moisture may freeze onto the coils and prevent effective cooling. If this happens, turn the knob to High Fan, and the thermostat control anti-clockwise. This will quickly defrost the cooling coil so that normal cooling can be resumed.

## 5. Air Swing Switch (Airflow direction adjustment Side-to-Side)

For fixed side-to-side air direction, set the Air Swing Switch to "ON" until the desired air direction is obtained, then move it to "OFF". For continuous side-to-side air circulation, set the Air Swing Switch to "ON" and leave it there.

# Product Component Identification

CW-1773SR

## Vertical Airflow Direction Vane (Airflow direction adjustment Up-and-Down)

The vertical airflow direction vane is controlled by positioning the vane to discharge the air upwards, downwards or straight out.

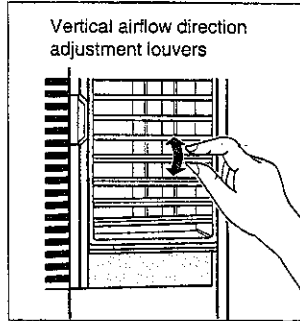

## Ventilation Lever

When the slide lever is at the:

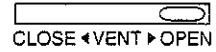

"**OPEN**" position, the vent. door opens to allow air, smoke or odours to be expelled from the room.



"**CLOSE**" position, the vent. door is closed and the air inside the room is circulated and conditioned.

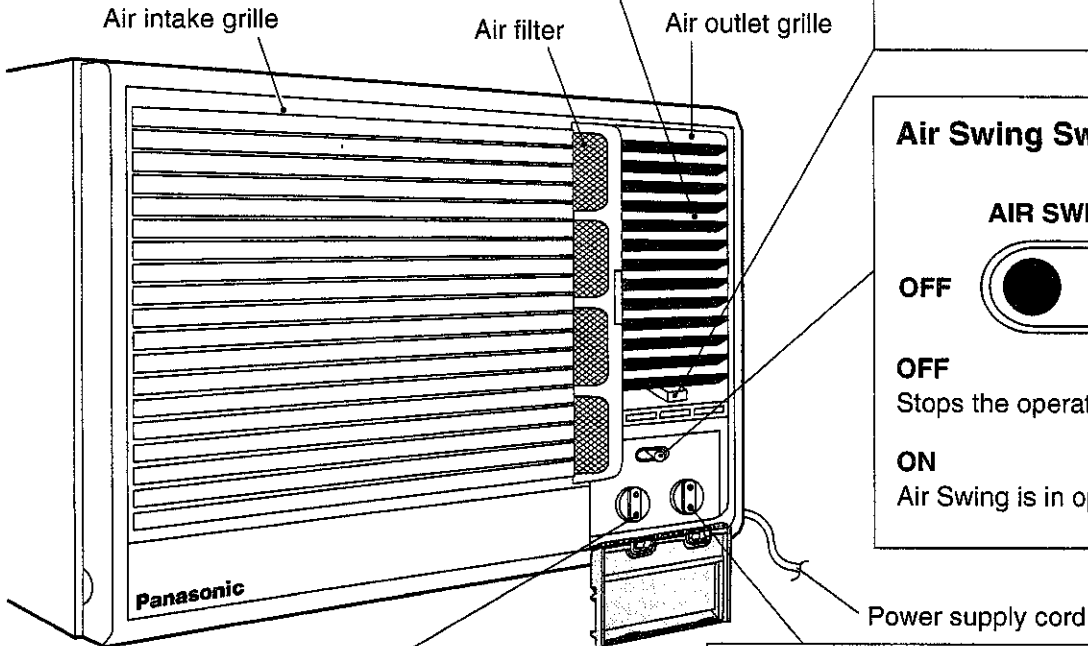

## Air Swing Switch

**AIR SWING**



**OFF**  
Stops the operation of Air Swing.

**ON**  
Air Swing is in operation.

## Thermostat Control Knob

When you turn the Thermostat Control Knob to the desired setting, the thermostat will automatically control the temperature of the indoor air. The further clockwise or anticlockwise you turn the knob, the cooler or warmer the indoor air will become.

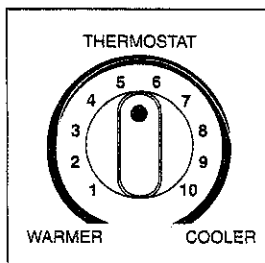

## Main Control Knob

**OFF**  
Stops all operations.

**FAN**  
Selects fan speed.

**LOW COOL**  
Air cooling operation at low fan speed.

**HIGH COOL**  
Air cooling operation at high fan speed.

**LOW HEAT**  
Air heating operation at low fan speed.

**HIGH HEAT**  
Air heating operation at high fan speed.

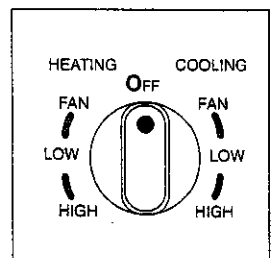

# Air Conditioner Operation

CW-1773SR (Cooling And Heating)

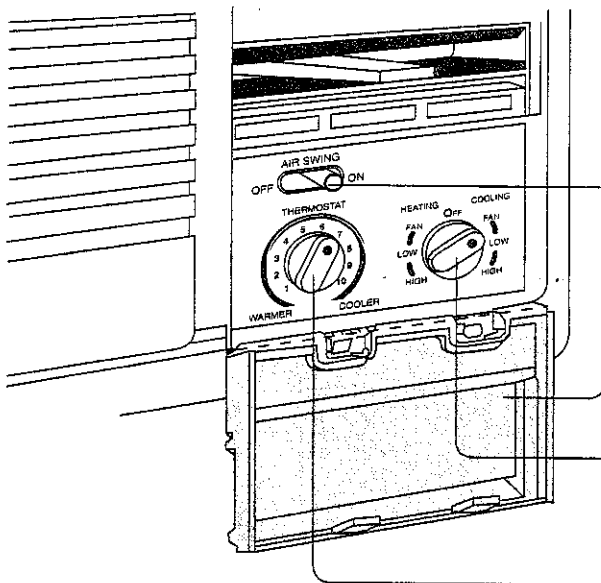

## 1. Power Supply

Set the Main Control Knob to the OFF position; confirm that the Power Supply Cord is connected to a proper AC outlet.

Recommended

Use the air conditioner under the following conditions:

- When humidity does not exceed 90% and room temperature is above 21°C.

Continuous operation at over 90% humidity may create condensation and waterdrops on the intake and outlet vents.

## 2. Open the cover.

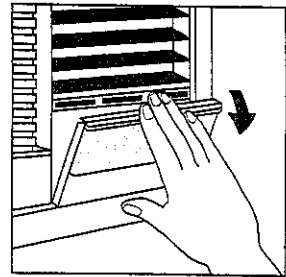

## 3. Main Control Knob

Set to either LOW COOL, HIGH COOL, LOW HEAT or HIGH HEAT. (Fan permits fan operation without cooling or heating)

\* Caution: If the Main Control Knob is turned off or turned to a fan only setting from a cooling operation setting, WAIT at least 3 minutes before resetting to a cooling or heating operation.

## 4. Thermostat Control Knob

Set the Thermostat Control Knob to the desired setting. (Usually "4 ~ 5" is a recommended setting for heating, and "6 ~ 7" for cooling.) If the room temperature is unsatisfactory after a reasonable amount of time, turn the control knob anticlockwise to make the room warmer, or clockwise to make the room cooler.

- When the Thermostat Control Knob is set to "10", moisture may freeze onto the coils and prevent effective cooling. If this happens, turn the Main Control Knob to Fan, and the Thermostat Control Knob anticlockwise. This will quickly defrost the cooling coil and allow normal cooling.

## 5. Air Swing Switch (Airflow direction adjustment Side-to-Side)

For fixed side-to-side air direction, set the Air Swing Switch to "ON" until the desired air direction is obtained, then move it to "OFF". For continuous side-to-side air circulation, set the Air Swing Switch to "ON" and leave it there.

# Operation Tips

## Operation for comfort and economy

### Do not overcool the room.

This is not good for health and waste electricity.

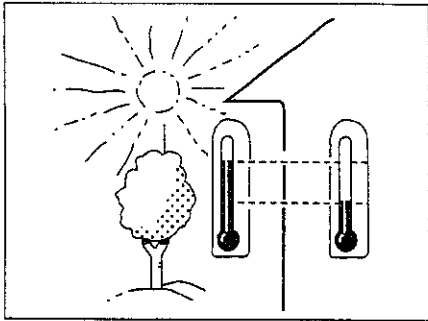

### Keep blinds or curtains closed.

Do not let sunshine enter the room directly when the air conditioner is in operation.

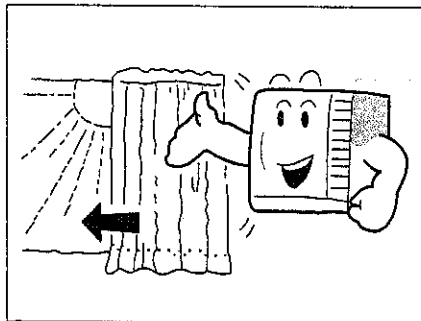

### Keep the room temperature uniform.

Adjust the vertical and horizontal airflow direction to ensure a uniform temperature in the room.

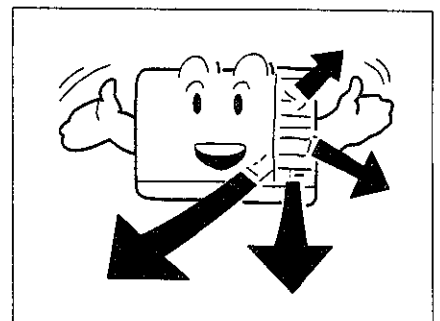

### Make sure that the doors and windows are shut tight.

Avoid opening doors and windows as much as possible to keep the cool air in the room.

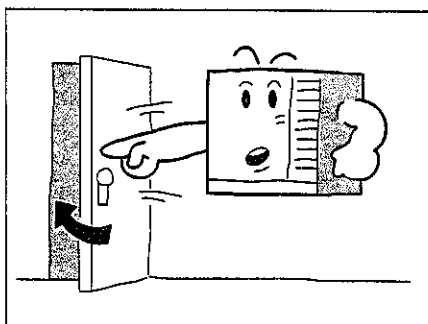

### Clean the air filter regularly.

Blockages in the air filter reduce the airflow and lower cooling and dehumidifying effects. Clean at least once every two weeks. (See page 8).

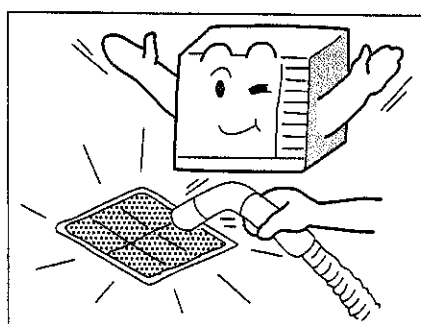

### Ventilate the room occasionally.

Since windows are kept closed, it is a good idea to open them and ventilate the room now and then.

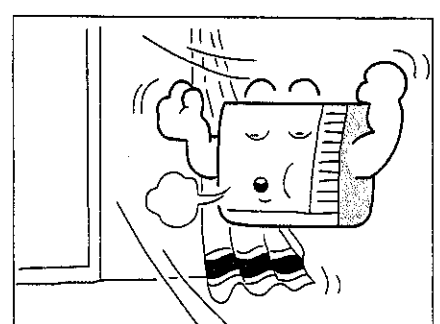

# Caution

## Do not pull out the power cord.

Damage to the cord may result in serious electrical shocks.

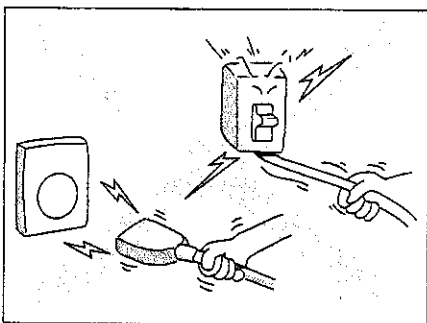

## Do not use the air conditioner for purposes other than cooling the room.

Do not use the air conditioner for other purposes such as drying clothes, preserving foods, keeping animals, or cultivating vegetables.

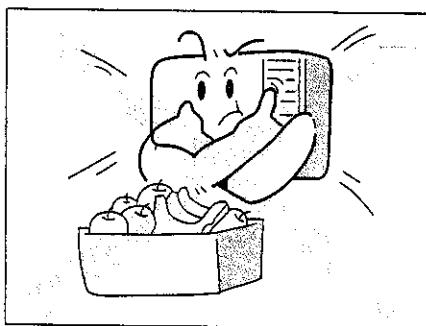

## Do not block the air intake and outlet vents.

This causes lowered performance and irregular operation. Do not insert sticks or other objects into these vents as it is dangerous to touch the electric components and the fan.

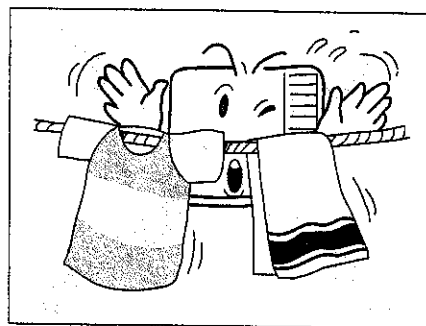

## Select the most appropriate temperature.

Take care to adjust the temperature to suit the conditions. Rooms occupied by infants, the elderly, or the sick should be kept at an appropriate temperature.

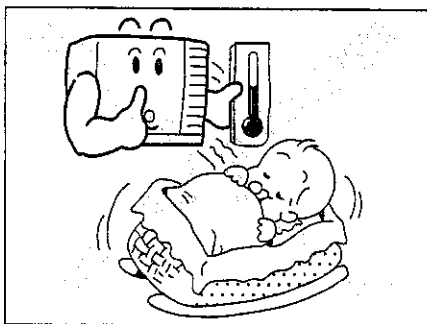

## Do not use heating apparatuses in the vicinity.

The air conditioner's plastic parts melt if exposed to excessive heat.

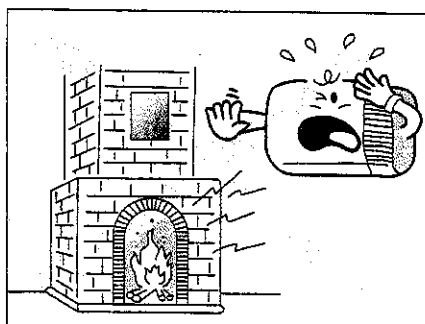

## Avoid exposing the body directly to a continuous unidirectional airflow for long periods.

This is not recommended for health reasons.

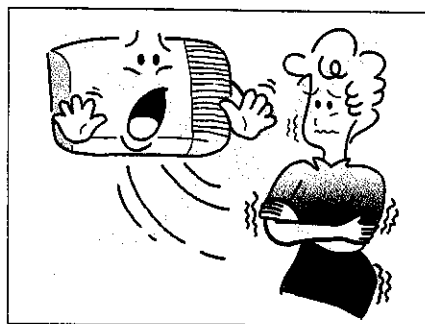



# Care And Maintenance

Always turn off the air conditioner and main power supply before cleaning to ensure safety.

## Air Filter

The air filter behind the intake grille should be washed at least every two weeks or as often as it needs cleaning.

### HOW TO CLEAN THE AIR FILTER

1. To remove the air filter, grasp the tab on the filter and pull to the right.

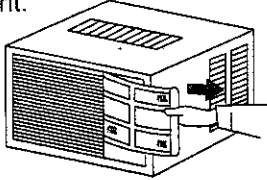

2. Vacuum the filter on the dusty side to remove light dust.

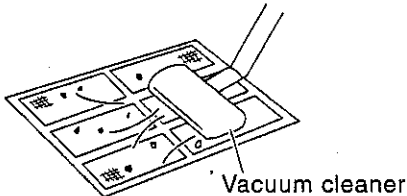

3. Wash the filter, cleaner side up under gently flowing water to wash out accumulated dust and lint.

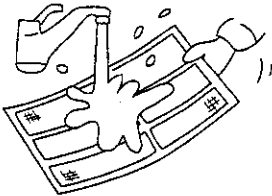

4. If the filter is very dirty, use a mild household detergent in the wash water.

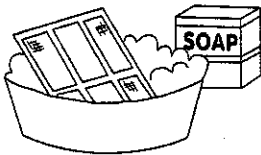

Let the filter dry thoroughly before reinstalling it. When reinstalling the filter, be sure the word "FRONT" is facing you as you slide the filter back into place.

## Front Grille

Clean the front grille with a clean cloth lightly dampened with mild liquid dish-washing detergent.

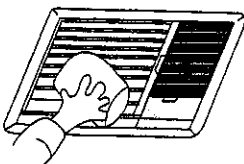

## Cabinet

Clean the cabinet with mild soap or detergent and lukewarm water.

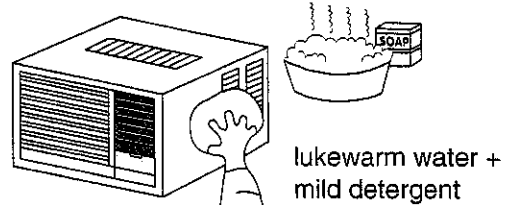

## Caution

Wipe off dirt with a soft, dry cloth (use a vacuum cleaner to remove dust from the air inlet.) Use a cloth and water less than 40°C to remove stubborn dirt (the cloth should be well-wrung). Do not use the following cleansers as they cause the paint to peel and lead to malfunctions: Benzene, thinner, scouring powder, chemical-soaked cloths, etc.



## Annual check

- \* After long-term usage of room air conditioners, dust and dirt will accumulate inside, lowering the performance. This may cause the generation of odour or may impede the drainage of the dehumidifying water.
- \* Besides regular cleaning of the air conditioner, a separate annual check is also recommended (chargeable). Please request your dealer to carry out these checks.

# Installation

Please read the following before installing the Air Conditioner.  
Select the Best Location for the most efficient cooling.

## Location

- The air conditioner should be installed in a dry place where there are no draughts.
- Condensation from the air conditioner must be drained to an appropriate location.
- Do not install in a location where flammable gas leaks are a possibility.
- Using in locations where the air is salty such as beside the sea or near hot spas, or where sulphurous gas is generated, may lead to a malfunction. Please consult your dealer.
- Ensure that the wall is strong enough to support the unit.

## How to Install

- There should not be any obstacles surrounding the unit.
- Prepare the installation hole slightly bigger than cabinet size.

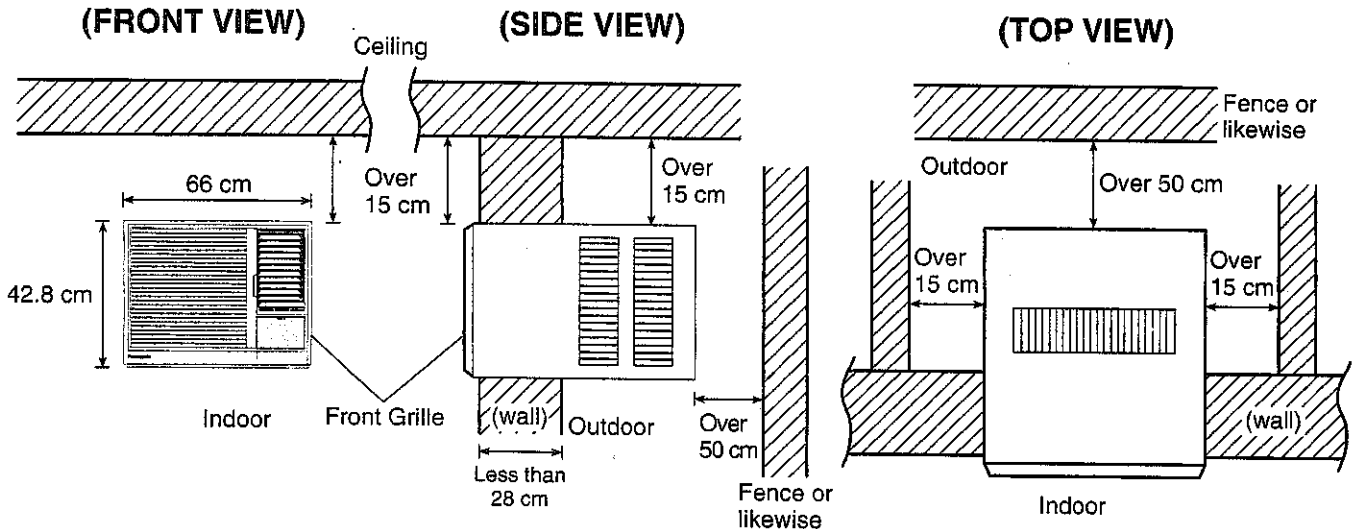

### 1) PREPARE CHASSIS

- Remove chassis locking bracket by loosening the screw.
- Slide the chassis out from the cabinet.

### 2) Place cabinet into opening and secure it by wood screws or nails.

- The cabinet should be installed tilted slightly lower to the rear for necessary condensate drainage. (Max. 10mm)

### 3) Slide Chassis into the cabinet which installed the above 2).

- The tubings or ducting part should not be touched with the cabinet.

### 4) Lock the chassis into cabinet by chassis locking bracket.

### 5) Place FRONT GRILLE onto CABINET by screws.

- To place the grille, hook top of grille onto top of cabinet, push bottom of grille in until it snaps into place. Secure the Front Grille with the screws at the right, left and centre of the grille.

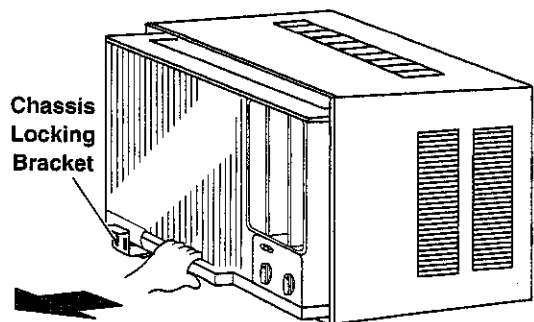

To place the Grille

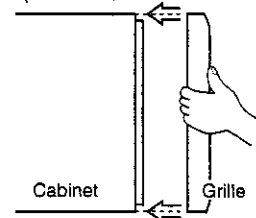

## Electrical work

- Always use at the rated voltage.
- Some installation locations may require installation of a shortcircuit breaker.
- A 10 Ampere time delay fuse or circuit breaker is required.
- Nominal cross sectional area of power supply wire must be 3 core x 1.0 mm<sup>2</sup> or above.
- The power supply must be from an independent circuit.
- All electrical installation must be made in accordance with local wiring and safety regulations wherever applicable.
- Please consult your dealer concerning installation requirements.

## Transferring

- When repositioning the air conditioner due to renovations, or when transferring to a different location, the removal and reinstallation of the unit requires an additional service charge. Please consult your dealer before moving.

## Removal of the grille

- 1) REMOVE AIR FILTER
- 2) REMOVE FRONT GRILLE
  - Loosen the screws at the right, left and centre of the grille.
  - Press the side of the cabinet firmly and at the same time pull the corner of the grille forward to unhook the tabs.
  - Slide the grille upward to free the two tabs at the top of the grille from slots at the top of the cabinet.

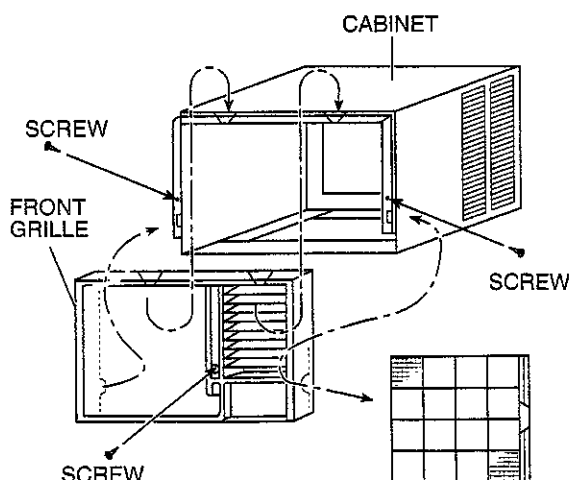

## Noise considerations

- Select an installation location that can support the weight of the air conditioner and one that will not cause increased operating noise and vibration.
- Ensure that airflow and noise from the rear side of the unit (outdoors) when installed do not cause inconvenience to neighbouring residents.
- Obstacles placed in front of the air outlet on the rear side of the unit (outdoors), or covers placed over it, cause excessive noise and a deterioration in performance.

## Drain water

To get the maximum cooling efficiency this air conditioner is designed to splash the condensate on the condenser coil.

This method is called "Slinger-Up System".

If the splashing sound annoys you, you can provide an outside drain by using the following procedure which may, however cause a small loss of performance.

1. Slide out the chassis from the cabinet.
  2. Remove the rubber plug from the body base plate. (For cooling model only)
  3. Install the drain pan prepared in the accessory kit to the corner of the cabinet with 2 screws.
  4. Connect the drain hose to the outlet on the drain pan bottom.
  5. Slide the chassis into its original place in the cabinet.
- Note:** Drain hose or tubing can be purchased locally to satisfy your particular needs.

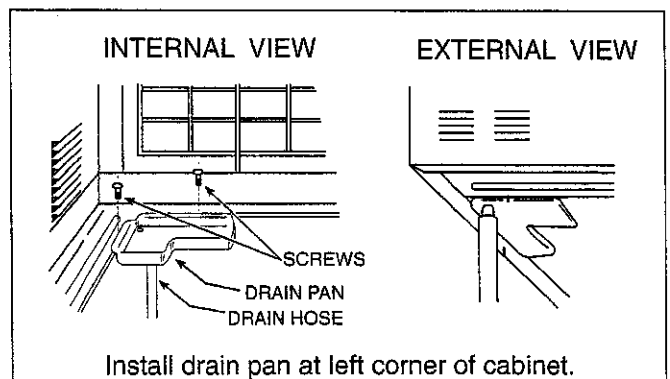

# Before Calling The Serviceman



Check the following points before requesting for repairs or service. If the malfunction persists, please contact your dealer.

Faults	Cause
Does not operate.	<ul style="list-style-type: none"> <li>• Has the fuse blown or has the circuit breaker been tripped?</li> <li>• Is the Main Control Knob set at Off?</li> </ul>
Does not cool or heat effectively.	<ul style="list-style-type: none"> <li>• Is the air filter dirty? See air filter cleaning instructions on page 8.</li> <li>• Are the air intake and outlet vents on the rear side of the unit (outdoors) blocked?</li> <li>• Is the air conditioner set for ventilation (the ventilation lever set at Open) or is the Main Control Knob set at either High Fan or Low Fan?</li> <li>• The Thermostat Control Knob may not be set low enough. Turn the knob further clockwise; the indoor air should become cooler or warmer.</li> <li>• The room may have been very hot when the air conditioner was first turned on. Allow time for it to cool down or heat up.</li> <li>• The cooling coils have iced up. To melt the ice, turn the Main Control Knob to FAN and the Thermostat Control Knob anti-clockwise.</li> </ul>
The room has a peculiar odour.	<ul style="list-style-type: none"> <li>• Check that this is not a damp smell exuded by the walls, carpet, furniture or cloth items in the room.</li> </ul>
Air conditioner operation is noisy.	<ul style="list-style-type: none"> <li>• For a noise that sounds like water flowing: This is the sound of freon circulating inside the air conditioner unit.</li> <li>• For a noise that sounds like a shower: This is the sound of the dehumidifying water being processed inside the air conditioning unit.</li> </ul>
It seems that condensation is leaking from the air conditioner.	<ul style="list-style-type: none"> <li>• Condensation occurs when the airflow from the air conditioner cools the warm room air.</li> </ul>

**Turn off the power as soon as any of the following events occur and contact your dealer.**

- The circuit breaker is frequently tripped or the fuse is frequently blown.
- Control knob operation is not normal.
- If water or foreign objects have accidentally entered the air conditioner.
- If there is abnormal sound during operation.

## **WARNING**

- (1) REMOVE POWER PLUG OR DISCONNECT FROM THE MAINS BEFORE SERVICING THIS APPLIANCE.
- (2) THIS APPLIANCE MUST BE EARTHED.

## **IMPORTANT**

1. WHEN THE POWER CORD IS CONNECTED TO THE MAINS THROUGH A MULTI POLAR SWITCH  
THERE MUST BE A MULTI POLAR SWITCH (DISCONNECTING MEANS) WITH A MINIMUM 3mm CONTACT GAP IN THE FIXED INSTALLATION CIRCUIT.
2. WHEN THE POWER PLUG IS CONNECTED TO THE RECEPTACLE

The wires in this main lead are coloured in accordance with the following code:

Green-and-yellow :	Earth
Blue :	Neutral
Brown :	Live

If the colours of the wires in the main lead of this appliance do not correspond with the coloured markings indentifying the terminals in your plug, proceed as follows:

The green-and-yellow wire must be connected to the terminal in the plug which is marked with letter E or by the earth symbol ⊕ or coloured green or green-and-yellow.

The blue wire must be connected to the terminal which is marked with the letter N or coloured black.

The brown wire must be connected to the terminal which is marked with the letter L or coloured red.

## **NOTE**

IF THE SUPPLY CORD IS DAMAGED, IT MUST BE REPLACED WITH A SPECIAL CORD OBTAINABLE AT AUTHORIZED SERVICE/PARTS CENTERS.

## Note

Please remember to record the following:

• Model Number

---

• Serial Number

---

• Dealer's Name

---

• Date Purchased

---

**Matsushita Electric Industrial Co., Ltd**

Central P.O. Box 288, Osaka 530-91, Japan