

Alaris® CC Syringe Pump

Directions For Use
EN

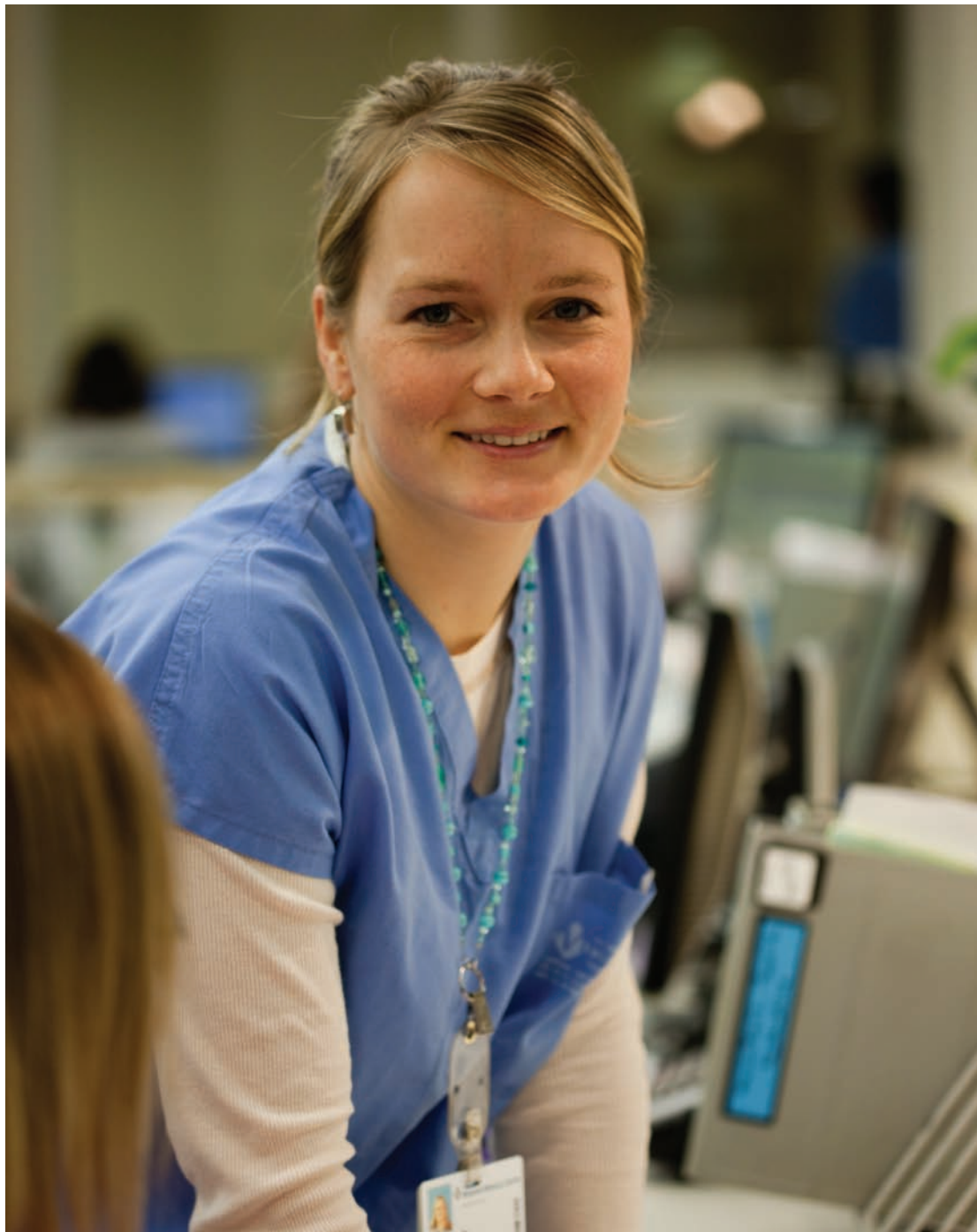

CE
0086

 CareFusion

	Page
Introduction	2
About This Manual	2
Quick Start Guide	2
Features of the Alaris® CC Syringe Pump	3
Controls and Indicators.....	4
Symbol Definitions	5
Main Display Features	6
Operating Precautions	7
Getting Started	9
Basic Features.....	14
Alarms and Warnings.....	18
Configured Options	19
Specifications	24
Compatible Syringes	25
Associated Products.....	25
Compatible Extension Sets.....	26
Maintenance.....	29
Occlusion Pressure Limits.....	31
IrDA, RS232 and Nurse call Specification	32
Trumpet Curves and Start-up Curves.....	33
Products and Spare Parts	34
Service Contacts	35
Document History.....	35

Introduction

The Alaris® CC Syringe Pump (herein after referred to as "pump") is a fully featured high end variable pressure syringe pump suitable for critical care applications.

Intended Use:

The pump is designed to meet the infusion requirements within the operating environment specified in this Directions For Use (DFU) including general wards, critical and intensive care, neonatal, operating rooms and accident and emergency rooms.

This pump is suitable for use by appropriately trained clinicians or nurses. The syringe pump is suitable to deliver fluids and medications via intravenous and epidural routes. Supporting fluid therapy, blood transfusions and parenteral feeding.

The Asena® brand name has been recently changed to the Alaris® brand name. This change in brand name has no effect on the intended use or functionality of the product. Recommended disposable products for use with this product may refer to either the Asena® brand name or Alaris® brand name and both types are suitable for use with this infusion pump.

The Alaris® CC Syringe Pump functions with a wide range of standard, single-use, disposable Luer lock syringes. It accepts syringe sizes from 5ml to 50ml. See the 'Compatible Syringes' section for a full list of compatible syringes.

- Simple to set up and easy to operate.
- Large graphics format display including pressure trending.
- Medical Device Interface (MDI) - a unique mounting mechanism.
- Rate Range from 0.1 to 1200ml/h.
- In-line pressure monitoring from 0 to 1000 mmHg.
- 24 hour logging of volume infused.
- Event logging records operation of pump.
- Advanced Communications and Nurse call interfaces.
- Configurable drug protocols for simplified drug dosing.

About This Manual





The user must be thoroughly familiar with the Alaris® CC Syringe Pump described in this manual prior to use.

All illustrations used in this manual show typical settings and values which may be used in setting up the functions of the pump. These settings and values are for illustrative use only. Where stated, a minimum infusion rate refers to a nominal rate of 1.0ml/h, and an intermediate infusion rate refers to a nominal rate of 5.0ml/h. The complete range of infusion rates, settings and values are shown in the Specifications section.

Quick Start Guide

1. Press the  button to turn the pump on.
2. **CLEAR SETUP?** - **NO** retains previous data. **YES** clears previous data.
3. Load syringe.
4. Confirm correct size and brand of syringe.
5. Ensure extension set is attached to syringe, but disconnected from patient. Insert pressure disc into pressure transducer.

If the PURGE SYRINGE option has been enabled then the prompt to purge screen is displayed and the set can be purged as required.





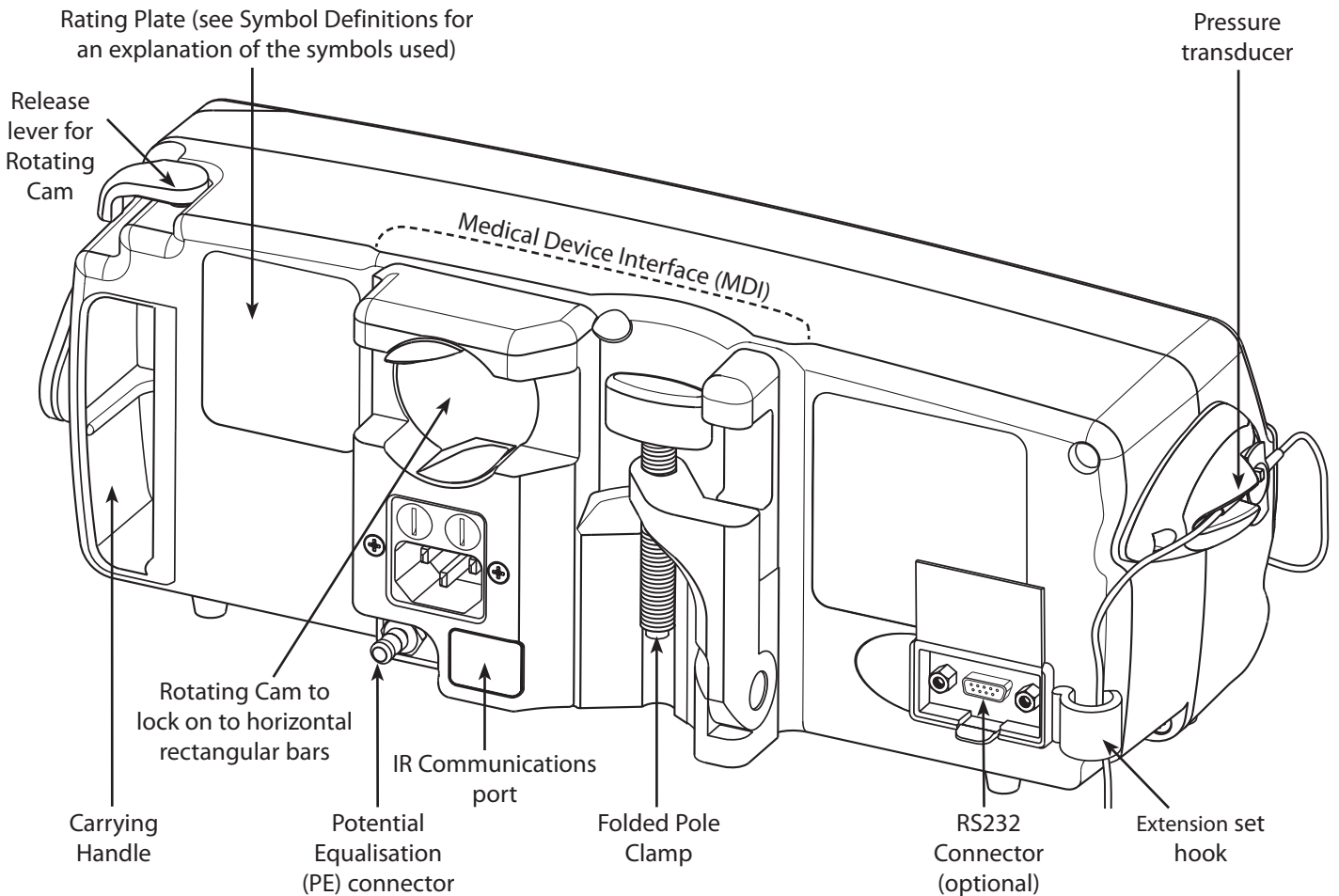
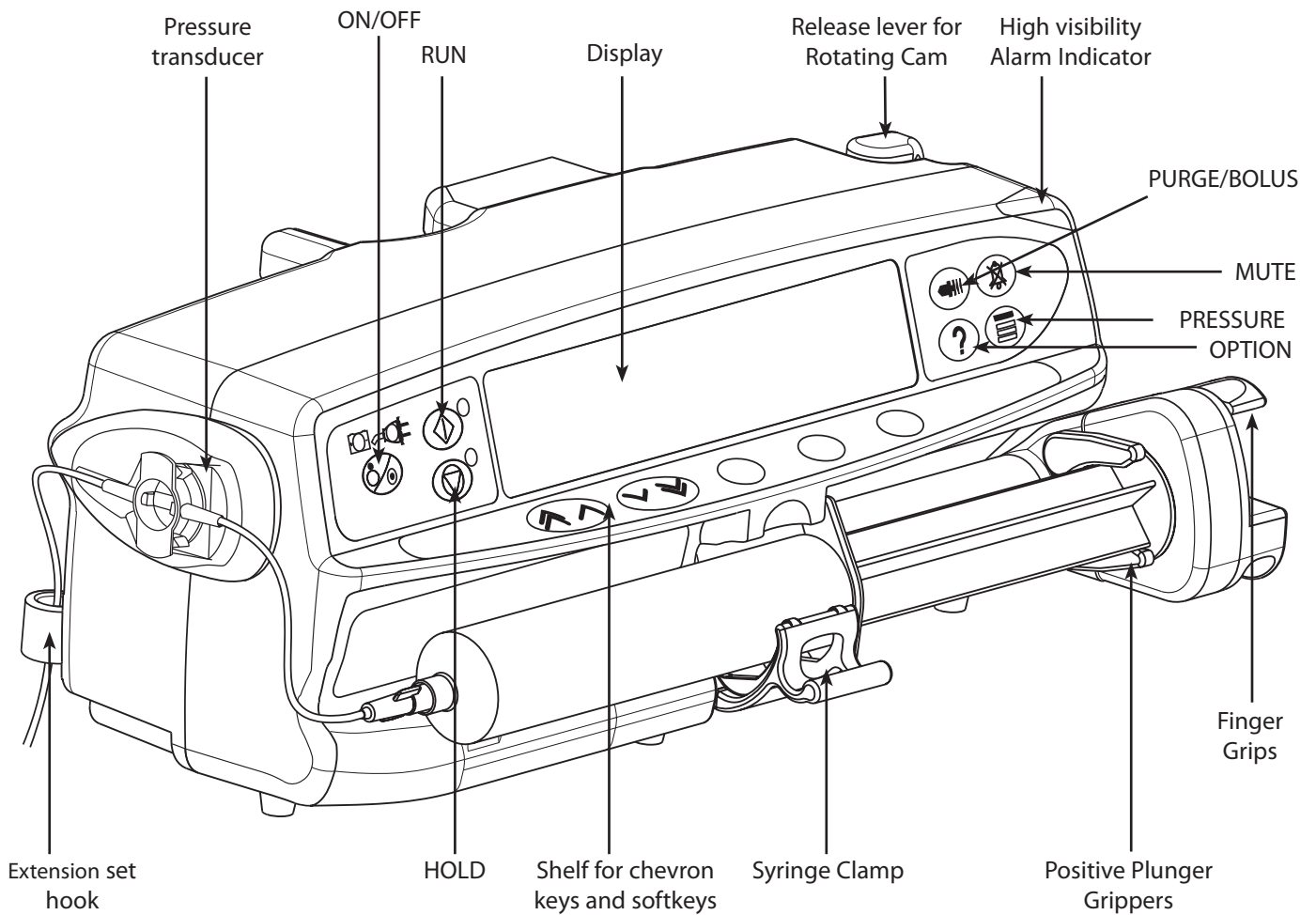



6. INFUSION RATE - Change rate if necessary using the   keys.
7. PURGE - Press the  button followed by the **PURGE** softkey.
8. Connect extension set to the patient access device.
9. Press the  button to start the infusion.

Features of the Alaris® CC Syringe Pump





Controls and Indicators

Controls:











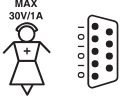

Symbol	Description
	ON/OFF button - Press once to switch the pump ON. Press and hold down for approximately 3 seconds to switch the pump OFF.
	RUN button - Press to start the infusion. The green LED will flash during infusion.
	HOLD button - Press to put the infusion on hold. The amber LED will be lit while on hold.
	MUTE button - Press to silence alarm for 2 minutes (configurable). The alarm will resound after this time. Press and hold until 3 beeps are heard for 15 minutes silence.
	<p>PURGE/BOLUS button - Press to access PURGE or BOLUS soft keys. Press and hold down soft key to operate.</p> <p>PURGE the extension set during set up.</p> <ul style="list-style-type: none"> ● Pump is on hold ● Extension set is not connected to the patient ● Volume Infused (VI) is not added <p>BOLUS - fluid or drug delivered at an accelerated rate.</p> <ul style="list-style-type: none"> ● Pump is infusing ● Extension set is connected to the patient ● VI is added
	OPTION button - Press to access optional features (see Basic Features).
	PRESSURE button - Use this button to display the pumping pressure trend display and alarm level.
	CHEVRON keys - Double or single for faster/slower increase or decrease of values shown on display.
	BLANK SOFTKEYS - Use in conjunction with the prompts shown on the display.

Indicators:

Symbol	Description
	BATTERY indicator - When illuminated the pump is running on the internal battery. When flashing the battery power is low with less than 30 minutes of use remaining.
	AC POWER indicator - When illuminated the pump is connected to an AC power supply and the battery is being charged.

Symbol Definitions



Labelling Symbols:

Symbol	Description
	Attention (Consult accompanying documents)
	Potential Equalisation (PE) Connector
	RS232/Nurse call Connector (Optional)
	Defibrillation-proof type CF applied part (Degree of protection against electrical shock)
IPX1	Protected against vertically falling drops of water
	Alternating Current
	Device complies with the requirements of Council Directive 93/42/EEC as amended by 2007/47/EC.
	Date of Manufacture
	Manufacturer
	Not for Municipal Waste
	Important information
	Fuse Rating
	Authorised representative in the European Community

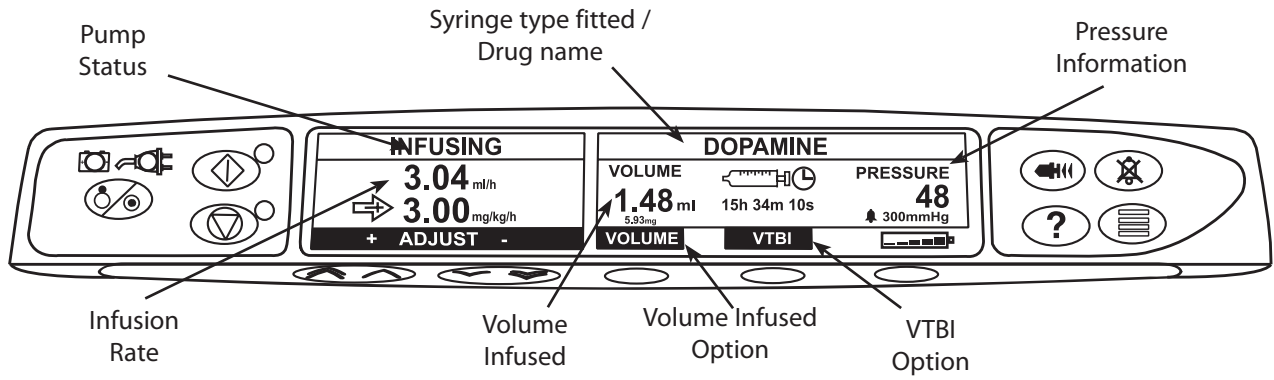
Main Display Features



Screen Icons:

Symbol	Description
	TIME REMAINING DISPLAY icon - Indicates time before syringe will require replacing.
	BATTERY icon - Indicates battery charge level to highlight when the battery will require recharging.

Operating Precautions

Disposable Syringes and Extension Sets

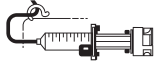
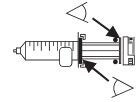

- This Alaris® CC Syringe Pump has been calibrated for use with single-use disposable syringes. To ensure correct and accurate operation, only use 3 piece Luer lock versions of the syringe make specified on the pump or described in this manual. Use of non-specified syringes or extension sets may impair the operation of the pump and the accuracy of the infusion.
- Uncontrolled flow or syphoning may result if the syringe is located incorrectly in the pump, or if it is removed from the pump before the extension set is properly isolated from the patient. Isolation may include closing a tap in the patient line or activating a flow stop clamp.
- Secure the extension set to the pump using the extension set hook at the rear of the pump. This provides protection against accidental dislodging of the syringe from the pump.
- When combining several apparatus and/or instruments with extension sets and other tubing, for example via a 3-way tap, the performance of the pump may be impacted and should be monitored closely.

Mounting the Pump

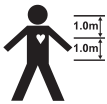

- The pump must be mounted within 1.0m above or below the patient's heart. The most accurate pressure monitoring in the extension set is achieved when the pump is positioned close to the patients heart level.
- Do not mount the pump in a vertical position with the syringe pointing upwards as this could lead to an infusion of air which may be in the syringe. To protect against the introduction of air the user should regularly monitor the progress of the infusion, syringe, extension line and patient connections and follow the priming procedure specified herein.

Operating Environment

- When using any infusion pump in conjunction with other pumps or devices requiring vascular access, extra care is advised. Adverse delivery of medication or fluids can be caused by the substantial variation in pressures created within the local vascular system by such pumps. Typical examples of those pumps are used during dialysis, bypass or cardiac assist applications.
- This pump is suitable for use in Hospital and clinical environments other than domestic establishments and those directly connected to the public single phase AC mains power supply network that supplies buildings used for domestic purposes. However, it may be used in domestic establishments under the supervision of Medical professionals with additional necessary appropriate measures. (Consult Technical Service Manual, appropriately trained technical personnel or CareFusion for further information).
- This pump is not intended to be used in the presence of a flammable anaesthetic mixture with air or oxygen or nitrous oxide.

Operating Pressure

- This is a positive pressure pump designed to achieve very accurate fluid administration by automatically compensating for resistance encountered in the infusion system.
- The pumping pressure alarm system is not designed to provide protection against, or detection of, IV complications which can occur.

Alarm Conditions



- Several alarm conditions detected by this pump will stop the infusion and generate visual and audible alarms. Users must perform regular checks to ensure that the infusion is progressing correctly and no alarms are operating.

Operating Precautions (continued)

Electromagnetic Compatibility and Interference



- This pump is protected against the effects of external interference, including high energy radio frequency emissions, magnetic fields and electrostatic discharge (for example, as generated by electrosurgical and cauterising equipment, large motors, portable radios, cellular telephones etc.) and is designed to remain safe when unreasonable levels of interference are encountered.
- **Therapeutic Radiation Equipment:** Do not use the pump in the vicinity of any Therapeutic Radiation Equipment. Levels of radiation generated by the radiation therapy equipment such as Linear Accelerator, may severely affect functioning of the pump. Please consult manufacturer's recommendations for safe distance and other precautionary requirements. For further information, please contact your local CareFusion representative.
- **Magnetic Resonance Imaging (MRI):** The pump contains ferromagnetic materials which are susceptible to interference with magnetic field generated by the MRI devices. Therefore, the pump is not considered an MRI compatible pump as such. If use of the pump within an MRI environment is unavoidable, then CareFusion highly recommends securing the pump at a safe distance from the magnetic field outside the identified 'Controlled Access Area' in order to evade any magnetic interference to the pump; or MRI image distortion. This safe distance should be established in accordance with the manufacturers' recommendations regarding electromagnetic interference (EMI). For further information, please refer to the product technical service manual (TSM). Alternatively, contact your local CareFusion representative for further guidance.
- **Accessories:** Do not use any non-recommended accessory with the pump. The pump is tested and compliant with the relevant EMC claims only with the recommended accessories. Use of any accessory, transducer or cable other than those specified by CareFusion may result in increased emissions or decreased pump immunity.
- This pump is a CISPR 11 Group 1 Class A device and uses RF energy only for its internal function in the normal product offering. Therefore, its RF emissions are very low and are not likely to cause any interference with the nearby electronic equipment. However, this pump emits a certain level of electromagnetic radiation which is within the levels specified by IEC/EN60601-1-2 and IEC/EN60601-2-24. If the pump interacts with other equipment, measures should be taken to minimise the effects, for instance by repositioning or relocation.
- In some circumstances the pump may be affected by an electrostatic discharge through air at levels close to or above 15kv; or by radio frequency radiation close to or above 10v/m. If the pump is affected by this external interference the pump will remain in a safe mode; the pump will duly stop the infusion and alert the user by generating a combination of visual and audible alarms. Should any encountered alarm condition persist even after user intervention, it is recommended to replace that particular pump and quarantine the pump for the attention of appropriately trained technical personnel. (Consult Technical Service Manual for further information).



Hazards

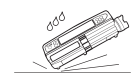

- An explosion hazard exists if the pump is used in the presence of flammable anaesthetics. Exercise care to locate the pump away from any such hazardous sources.
- **Dangerous Voltage:** An electrical shock hazard exists if the pump's casing is opened or removed. Refer all servicing to qualified service personnel.
- When connected to an external power source, a three-wire (Live, Neutral, Earth) supply must be used. If the integrity of the external protective conductor in the installation or its arrangement is in doubt, the pump should be operated from the battery.
- Do not open the RS232/Nurse Call protective covering when not in use. Electrostatic discharge (ESD) precautions are required when connecting RS232/Nurse Call. Touching the pins of the connectors may result in ESD protection failure. It is recommended that all actions must be taken by appropriately trained personnel.
- If this pump is dropped, subjected to excessive moisture, fluid spillage, humidity or high temperature, or otherwise suspected to have been damaged, remove it from service for inspection by a qualified service engineer. When transporting or storing the pump, use original packaging where possible, and adhere to temperature, humidity and pressure ranges stated in the Specifications section and on the outer packaging.

Getting Started



Initial Set-up



Before operating the pump read this Directions For Use manual carefully.

1. Check that the pump is complete, undamaged and that the voltage rating specified on the label is compatible with your AC power supply.
2. Items supplied are:
 - **Alaris® CC Syringe Pump**
 - **User Support CD (Directions For Use)**
 - **AC Power Cable (as requested)**
 - **Protective Packaging**
3. Connect the pump to the AC power supply for at least 2½ hours to ensure that the internal battery is charged (verify that the  is lit).

Language Selection

1. On initial start-up the pump will display the Select Language screen.
2. Select the required language from the list displayed using the   keys.
3. Press the **OK** softkey to confirm your selection.



The pump will automatically operate from its internal battery if the pump is switched on without being connected to the AC power supply.

Should the pump fail to perform correctly, replace in its original protective packaging, where possible and contact a qualified service engineer for investigation.

Getting Started (continued)



Do not mount the pump with the AC power inlet or the syringe pointing upwards. This could affect the electrical safety in the event of a fluid spill or lead to the infusion of air which may be in the syringe.

Pole Clamp Installation

The pole clamp is fitted to the rear of the pump and will provide secure fixing to vertical I.V. poles of a diameter between 15 and 40 mm.

1. Pull the folded pole clamp towards you and unscrew the clamp to leave enough room for the size of the pole.
2. Place pump around pole and tighten screw until the clamp is secured to the pole.



Ensure the pole clamp is folded away and stored within the recessed area at the rear of the pump before connecting to a Docking Station/Workstation* or when not in use.

Never mount the pump such that the IV infusion stand becomes top heavy or unstable.

Recessed area

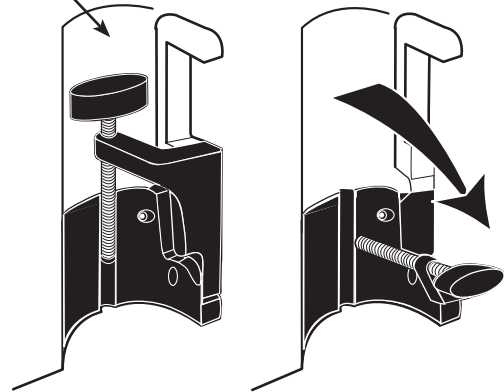

Docking Station/Workstation* or Equipment Rail Installation

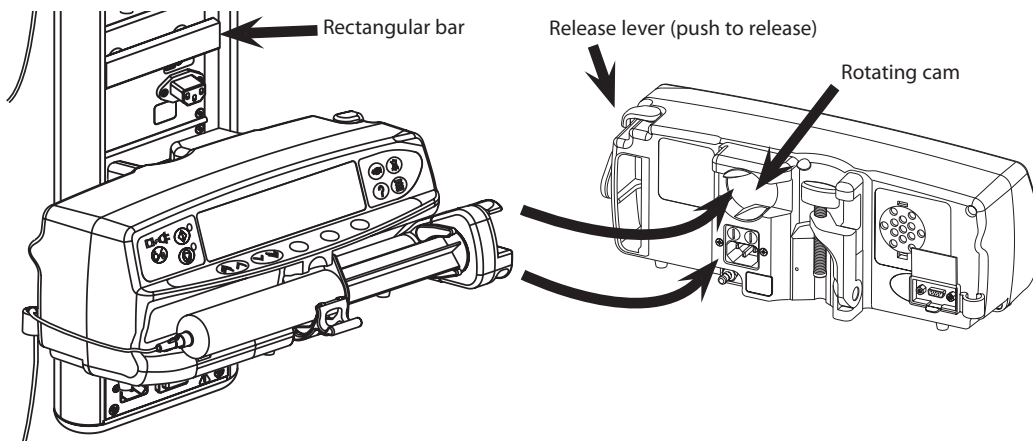

The rotating cam can be fitted to the rectangular bar on the Docking Station/Workstation* or the equipment rail measuring 10 by 25 mm.

1. Align the rotating cam on the rear of the pump with the rectangular bar on the Docking Station/Workstation* or the equipment rail.
2. Hold the pump horizontally, push the pump firmly onto the rectangular bar or equipment rail.
Ensure that the pump 'clicks' securely into position onto the bar.
3. To release, push the release lever and pull the pump forwards.

*Alaris® DS Docking Station, Asena® IDS Docking Station, and Alaris® Gateway Workstation.

Getting Started (continued)

Loading and Confirming a Syringe



Warning: To securely load and confirm a syringe carefully follow the steps below. An incorrect loading of a syringe may result in misidentification of the syringe type and size. If then confirmed, this may lead to significant inaccuracy of the infusion rate and may also affect pump performance.

Only use a syringe of the type stated on the pump or in this manual. Using an incorrect syringe could adversely affect the accuracy of the infusion rate and may also affect pump performance.

When drawing fluid into the syringe, draw enough to compensate for any 'dead space' volume in the extension set and syringe at the end of infusion as this cannot be fully infused.

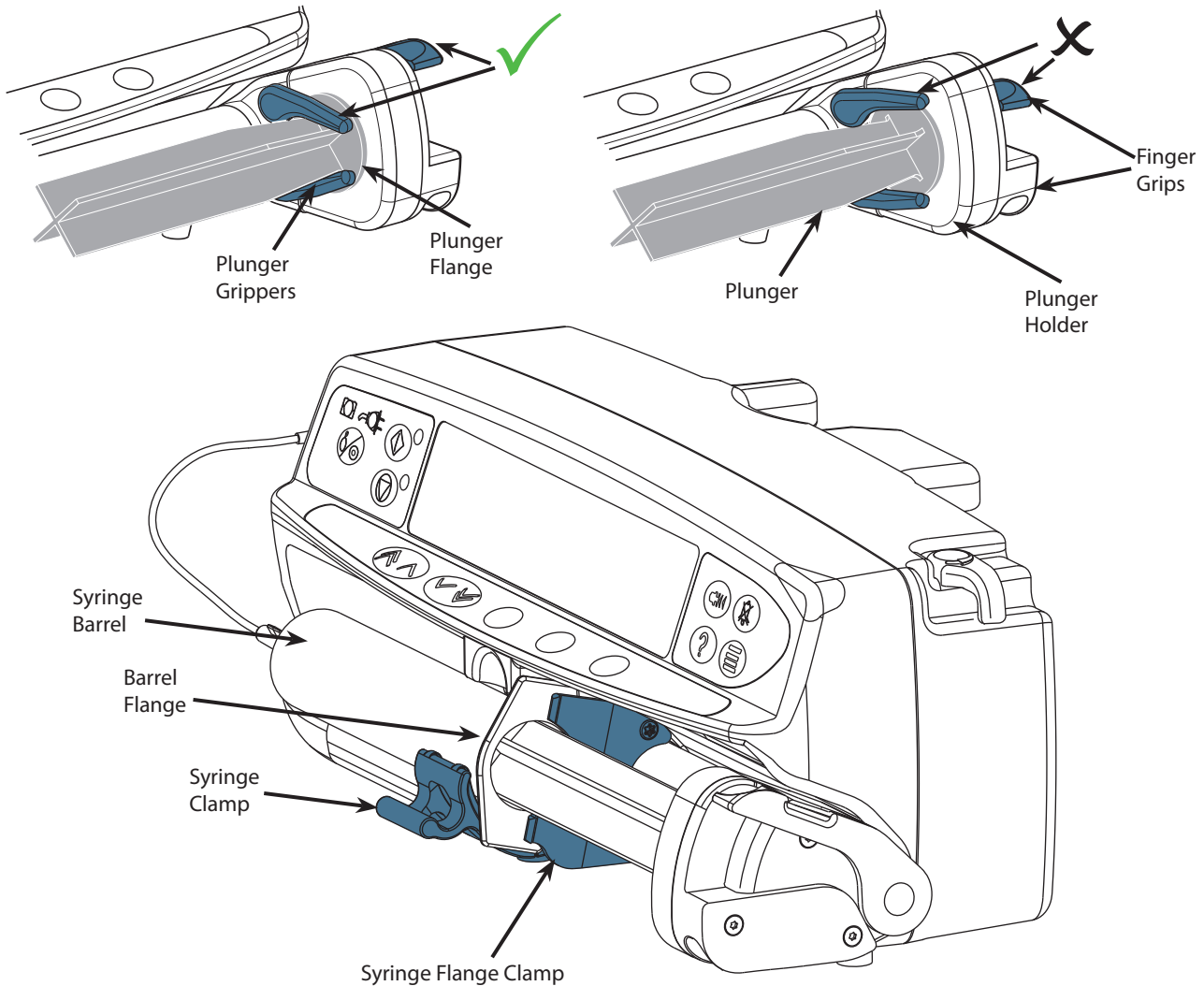

Place the pump on a stable horizontal surface or secure as described previously.

Prepare, load and prime the single-use disposable syringe and extension set using standard aseptic techniques.

1. Squeeze the finger grips together on the plunger holder and slide the mechanism to the right.
2. Pull the syringe clamp forward and down.



3. Insert the syringe ensuring that the barrel flange is located in the slots on the syringe flange clamp.



To ensure the syringe is loaded correctly, place the barrel flange in the space between the syringe clamp and the syringe flange clamp. This is correct if the syringe remains in position before the syringe clamp is closed.

4. Lift the syringe clamp until it locks against the syringe barrel.

5. Squeeze the finger grips on the plunger holder and slide the mechanism to the left until it reaches the plunger end.
6. Release the finger grips. Ensure that the plunger grippers are securing the plunger in place and the finger grip returns to its original position.



7. Ensure that the syringe type and size match those displayed on the pump then press **CONFIRM**. If required, the make of syringe can be changed by pressing the **TYPE** softkey.

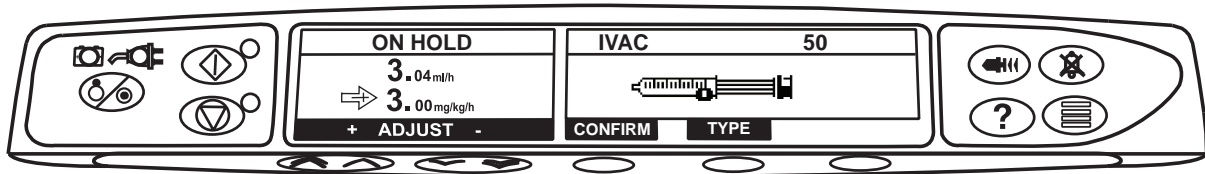

Note: If the **PURGE SYRINGE** option has been enabled then the prompt to purge screen is displayed and the extension set can be purged as required, however ensure that the extension set is not connected to the patient during this process.



CareFusion recommends to limit the number of configured syringe types and sizes available for selection on the pump.

Secure the extension set using the extension set hook at the rear of the pump. This provides protection against accidental dislodging of the syringe from the pump.

Ensure that both plunger grippers are fully locked onto the plunger flange and the upper finger grip has returned to its original position.

Getting Started (Continued)

Starting the Pump

1. Connect the pump to an AC power supply using the AC power cable.

Press the  button.

- The pump will run a short self-test. Ensure that two beeps are activated during this test.
- Check the display test pattern and ensure that no rows are missing.
- Check that the displayed time and date are correct.

Note: A warning - **REPAIRING LOGS**, may be displayed if event log information was not completely stored at the previous power down. This is for information only, the pump will continue to power up as normal.

2. **CLEAR SETUP?** - Answering **NO** will retain all previous rate and volume settings. **YES** will automatically reset the rate and volume settings to zero.
3. **LOAD SYRINGE** - Load the syringe according to the procedure in this manual.
4. Insert the pressure disc into the pressure transducer.

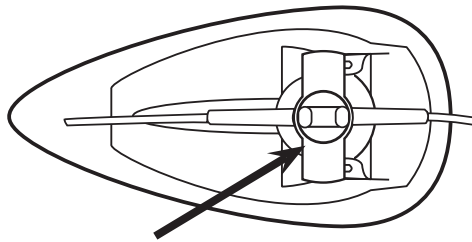



PRESSURE TRANSDUCER - Detects if an infusion line with a pressure disc is fitted. The pressure transducer will measure positive infusion line pressures.

Warning - To remove or insert pressure disc from or into pressure transducer assembly, insert finger into the recess in the pressure disc and pull forward or push back with care. **DO NOT PULL THE EXTENSION SET TO REMOVE OR TO INSERT THE PRESSURE DISC.**



5. **CONFIRM SYRINGE** - Check that the syringe type and size being used matches the display. If required, the make of syringe can be changed by pressing the **TYPE** button. Press **CONFIRM** when the correct type and size are shown.

If the PURGE SYRINGE option has been enabled then the prompt to purge screen is displayed and the set can be purged as required.

6. **INFUSION RATE** - Check the rate shown if old patient data has been retained and change the rate if necessary using the   keys.
7. **PURGE** (if required) - Press the  button and then press and hold the **PURGE** softkey until fluid flows and the purging of the syringe extension line is complete. Release the softkey. The volume used during purging will be displayed.



Purge extension set, massaging pressure disc to prevent ballooning and ensuring all air removal.

8. **CONNECT TO PATIENT** - Connect the extension set to the patient access device.
9. **START** - Press  to commence operation. **INFUSING** will be displayed. The AMBER STOP light will be replaced by the flashing GREEN START light to indicate that the pump is in operation.
10. **STOP** - Press  to halt the operation. **ON HOLD** will be displayed. The amber light will replace the green light.

FULLY DEDICATED Alaris® CC Syringe Pump - to start an infusion a pressure disc must be fitted.

SEMI DEDICATED Alaris® CC Syringe Pump - to start an infusion with Drug and Dosing set a pressure disc must be fitted.

Basic Features

Purge

The  button allows the delivery of a limited volume of fluid in order to purge the extension set prior to being connected to a patient or after changing a syringe.

1. Press the  button when the pump is not infusing. Ensure that the extension set is not connected to the patient.
2. Press and hold the **PURGE** softkey until fluid flows and the purging of the IV infusion set is complete. The volume used during purging will be displayed, but it is not added to the volume infused.
3. When purging is complete release the **PURGE** softkey. Press the **QUIT** softkey to exit back to the main display.



The pump will not purge if the rate lock has been enabled. During PURGE the pressure limit alarms are temporarily increased to their maximum level.

Bolus Infusion

Bolus - Administering a controlled volume of fluid or drug at an increased rate for diagnostic or therapeutic purposes. The pump should always be infusing and always attached to the patient. (Drugs given by an IV bolus could achieve immediate and high drug concentration levels.)

Bolus can be used at the start of an infusion or during an infusion.

The bolus feature can be configured to:

- a) BOLUS Disabled
- b) BOLUS Enabled
 - i) Hands On only
 - ii) Hands On and Hands Free

BOLUS Disabled



If configured to *Disabled*, pressing the  button will have no effect and the pump will continue to infuse at the set rate.



A Hands On bolus and Hands Free bolus cannot be administered if the "RATE LOCK" is active. During BOLUS the pressure limit alarm is temporarily increased to the maximum level.





BOLUS Enabled - Hands On

In "Hands on" Bolus, press and hold the (flashing) **BOLUS** soft key to deliver the required bolus. The bolus rate can be adjusted. The bolus volume is limited in the configuration.

1. During infusion press the  button once to display the bolus screen.
2. Use the   keys to adjust the bolus rate if required.
3. To deliver the bolus press and hold the **BOLUS** softkey. During the bolus, the volume being infused is displayed. When the desired bolus volume has been delivered or the bolus volume limit is reached, release the softkey. The bolus volume is added to the total volume infused.

BOLUS Enabled - Hands On and Hands Free

The "Hands Free" Bolus is delivered with a single press of the (flashing) **BOLUS** soft key. On initial use the bolus rate and bolus volume are at default values and can be changed. On subsequent uses, the bolus rate and bolus volume will remain as per previously set and can be changed as required. Following **CLEAR SETUP**, the default bolus rate is determined via the configuration and the default bolus volume is 0.1ml.

1. During infusion press the  button to display the "Hands Free" bolus selection screen.
2. Press the **YES** softkey to go to "Hands Free" selection bolus screen, press the **HANDS ON** softkey for "Hands On" bolus (see section above).
3. Use the   keys to set the bolus volume/dose required; If necessary press the **RATE** softkey to adjust the bolus delivery rate (150/300/600/900/1200ml/h). **Note:** Rate may be restricted by the syringe size and the **CAP BOLUS RATE**.
4. Press the flashing **BOLUS** softkey once to begin the delivery of the preset bolus. The display will show the bolus being delivered, the bolus counting down and revert to main infusion display upon completion of the bolus.
5. To terminate a bolus being delivered press **STOP** softkey. This will stop the bolus and continue infusing at the set rate. Press the  button to stop the bolus delivery and place the pump on hold.
6. If the bolus volume reaches the set bolus volume limit the bolus will stop and the pump will revert to infuse at the set infusion rate and continue infusing.



If the "Hands Free" bolus option is active, then this feature will be cancelled following any interruption in delivery, e.g. occlusion, even if the bolus delivery is incomplete.

If the volume to be infused (VTBI) is reached during a bolus, the VTBI complete alarm will sound. Press c to silence the alarm or CANCEL to acknowledge the alarm. See 'VTBI' section for more details on VTBI operation.

Manual Bolus

The "Manual Bolus" is delivered by moving the plunger drive mechanism forward while the pump is infusing. This method of delivering a bolus is not recommended as best clinical practice.

The syringe must be confirmed and the plunger mechanism has to move from an engaged position to disengage and then re-engage position.

A minimum travel of 1mm (leadscrew pitch) must be detected to register.

Basic Features (Continued)

Auto Set Pressure (If enabled)



If the Auto Set Pressure Option is enabled then the pump AUTOMATICALLY adjusts the pressure occlusion limit.

- After 15 minutes of infusion the pump AUTOMATICALLY adjusts the occlusion pressure limit to X mmHg (the AUTO OFFSET value, 15-100mmHg), above the average infusion pressure since the start of the infusion.

Pressure Level with pressure set fitted

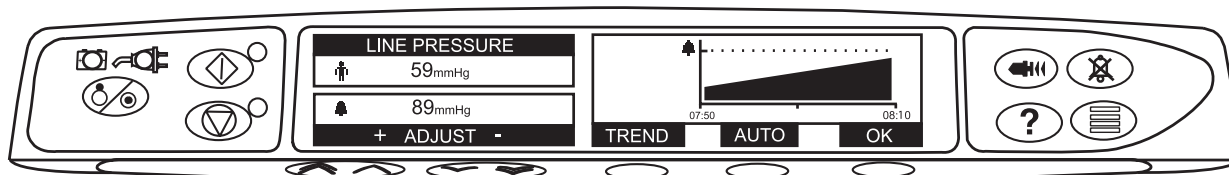

1. To check and adjust the pressure level press the  button. The display will change to show a 20 minute pressure trend graph displaying the pressure alarm level and the current pressure level.

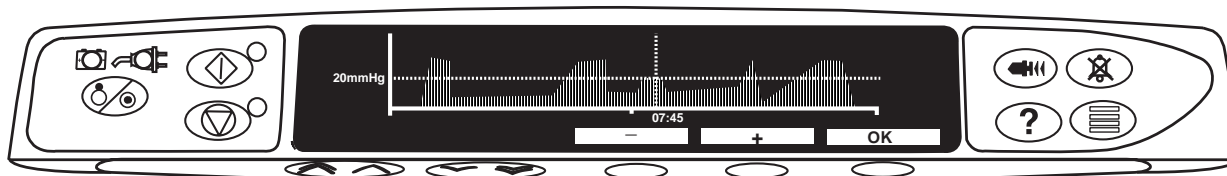

2. Press the   keys to increase or decrease the pressure alarm level. The new level will be indicated on the display.
3. The **AUTO** Pressure feature may be used when a stable pressure has been achieved over a short period of infusion. If **AUTO** Pressure has been enabled the automatic pressure alarm level is calculated and set by pressing the **AUTO** softkey.
4. Press the **TREND** softkey to view the pressure trend of the previous 12 hours. The pressure trend can be viewed at 15 minute intervals by using the +/- softkeys. The pressure trend graph displays the pressure at a given time.
5. Press the **OK** softkey to exit the pressure screen.



Pressure Level without pressure set fitted (not applicable when FULLY DEDICATED)

1. To check and adjust the pressure level press the  button. A bar graph will be displayed showing the pressure alarm level and the current pressure level.
2. Press the   keys to increase or decrease the alarm level. The new level will be indicated on the display.
3. Press **OK** to exit the screen.



The interpretation of pressure readings and occlusion alarms are the responsibility of the clinician depending on the specific application.

Rate Lock



If Rate Lock is enabled, when the infusion rate has been set and the infusion started (or following a bolus infusion) the rate lock prompt will appear on the main display.

To select the rate lock function press the **YES** softkey. Press the **NO** softkey if the rate lock is not required.

When rate lock is enabled, the following are unavailable:

- **Changing the infusion rate / titration**
- **Bolus / purge**
- **Switching the pump off**
- **VTBI over time infusions.**

To disable the rate lock if selected:

1. Press the  button to access the options menu.
2. Select the **UNLOCK RATE** option using the   keys and press the **OK** softkey.

To enable the rate lock if not selected:

1. Press the  button to access the options menu.
2. Select **RATE LOCK** and press the **OK** softkey.



Basic Features (Continued)

Drugs and Dosing

The following options enable the pump to be set-up for use with a specific drug and/or dosing protocol. Drugs are pre-configured in a drug library (see Configured Options) to enable rapid selection of the drug name, dosing units and default rate. For increased security using a configured drug, maximum and minimum safety limits are programmable for concentration and dose rates.

Note: The dose infused display is the product of the volume infused and the confirmed concentration. If dosing is confirmed while the volume infused is greater than 0.0ml or a drug was previously selected the dose could be inaccurate. If the dose displayed could be inaccurate the digits will flash on screen. To reset the flashing, the volume needs to be cleared.

To access the Drugs and Dosing menu:

1. Press the  button to first access the options menu.
2. Select **DRUGS AND DOSING** from the list using the   keys.
3. Press the **OK** softkey to confirm the selection.

Dosing Only:



1. Select **DOSING ONLY** from the list and press **OK**.
2. Enter the dosing information as prompted on the display.
3. Press the **OK** softkey to confirm the dosing information.
4. The **BACK** softkey may be used at any time to return to the previous screen.

See note below *.

Drug Name Only: (available if Drugs are configured)





1. Select a drug name from the list and press the **OK** softkey.
2. If no protocol is required press the **NO** softkey.
3. If no dosing is required press the **NO** softkey.

Pre-configured drug dosing protocol: (available if Drugs are configured)

1. Select the drug name from the list displayed using the   keys. Press the **OK** softkey to confirm the selection.
2. Press the **YES** softkey to select **PROTOCOL**. This will select the pre-defined protocol for the selected drug.
3. Enter the dosing information prompted on the display for the selected drug using the **OK** softkey.

See note below *.



User-programmed drug dosing: (available if Drugs are configured)

1. Select the drug name from the list displayed using the   keys. Press the **OK** softkey to confirm the selection.
2. Press the **NO** softkey to avoid selecting **PROTOCOL**.
3. Press the **YES** softkey to select **DOSING**. This now enables user-programmed information to be entered.
4. Enter the required dosing information as prompted on the display, using the   keys and the **OK** softkey.

See note below *.





* **Note:** Rate values will flash if either the rate (ml/h) or dose rate are outside the permitted range; and confirmation will not be possible.

Clear drugs and/or dosing: (available if a drug is selected)

1. Select **CLEAR DRUGS AND DOSING** or **CLEAR DRUG NAME** (displayed if a name only is selected) using the   keys. Press the **OK** softkey to confirm the selection.

Volume to be Infused (VTBI)

This option allows a specific volume to be infused to be set. Rate at the end of this VTBI can also be set, selecting from stop, KVO, or continuous infusion at the set rate.

1. Press the **VTBI** softkey to select the volume to be infused option.
2. Enter the volume to be infused using the   keys and press the **OK** softkey.
3. Select the rate at the end of the VTBI using the   keys to scroll through the on-screen choices. The default is stop.
4. Press the **OK** softkey to enter the rate and exit the VTBI menu.

Clear Volume

This option enables the volume infused to be cleared.



1. Press the **VOLUME** softkey to display the **CLEAR VOLUME** option.
2. Press the **YES** softkey to clear the volume. Press the **NO** softkey to retain the volume.

Selecting YES resets the volume infused in the 24H LOG option.

Basic Features (Continued)

Rate Titration





If Rate Titration is **enabled** the rate can be adjusted **while infusing**:

1. Select the new rate using the   keys.

The message < START TO CONFIRM > will flash on screen and pump continues to infuse at the original rate.

2. Press the  button to confirm the new infusion rate and start infusing at the new rate.

If Rate Titration is **disabled** the rate can only be adjusted **whilst on hold**:

1. Press the  button to put the pump on hold.
2. Select the new rate using the   keys.
3. Press the  button to start infusing at the new rate.







? Dosing Summary

To review currently selected dosing information:

1. Press the  button to access the options menu.
2. Select **DOSING SUMMARY**.
3. Review the information and then press the **QUIT** softkey.



? Set VTBI over Time

This option allows a specific VTBI and delivery time to be set. The rate necessary to deliver the required volume within the specified time is calculated and displayed.

1. Stop the infusion. Press the  button to access the options menu.
2. Select the **SET VTBI OVER TIME** option using the   keys and press the **OK** softkey.
3. Adjust the volume to be infused using the   keys. When the desired volume has been reached press the **OK** softkey.
4. Enter the time over which the volume is to be infused. The infusion rate will automatically be calculated. Press the **OK** softkey to enter the value.
5. Select the rate at VTBI end from the list using the   keys and press the **OK** softkey. The default is STOP.

? 24 Hour Log

This option allows the 24 hour log of volume infused to be reviewed.

1. Press the  button to access the options menu.
2. Select the **24H LOG** option using the   keys and press the **OK** softkey.





The display shows the hourly volume infused. The volume infused shown in brackets is the total volume infused since the volume was last cleared. See example below:

07:48 - 08:00 4.34ml (4.34ml)
08:00 - 09:00 2.10ml (6.44ml)
09:00 - 10:00 2.10ml (8.54ml)
VOLUME CLEARED

3. Press the **QUIT** softkey to exit the log.

? Event Log

This option allows the event log to be reviewed. It can be enabled/disabled.

1. Press the  button to access the options menu.
2. Select the **EVENT LOG** option using the   keys and press the **OK** softkey.
3. Scroll through the log using the   keys. Press the **QUIT** softkey to exit the log.



? Drug Name

To display selected drug name:

1. Press the  button to access the options menu.
2. Select **DRUG NAME**.
3. Press the **OK** softkey to confirm the drug name or press the **QUIT** softkey to exit the option.







Alarms and Warnings

Alarms are indicated by a combination of an audible alarm, flashing alarm indicator and a descriptive message in the display.

1. First press the  button to silence the alarm for a maximum of 2 minutes*, then check the display for an alarm message. Press **CANCEL** to cancel the alarm message.
2. If the infusion has stopped, rectify the cause of the alarm then press the  button to resume the infusion.





If the pump initiates a safety processor alarm condition (an audible high pitched continuous shrill accompanied with a red alarm indicator) and there is no error message displayed on the pump, remove the pump from service for examination by a qualified service engineer.

<i>Display</i>	<i>Description and Troubleshooting Guide</i>
DRIVE DISENGAGED	The drive system has been disengaged during operation. Check the finger grips and the position of the syringe.
OCCLUSSION	Excessive pressure measured at the syringe plunger exceeding the alarm limit. Identify and remove the cause of the blockage in the drive, syringe, or administration system before restarting the infusion.
LINE OCCLUSSION	Excessive pressure measured in the extension set at the pressure sensing disc exceeding the alarm limit. Identify and remove the cause of the blockage in the drive, syringe, patient access site, or administration system before restarting the infusion.
CHECK SYRINGE	Incorrect size of syringe has been fitted, the syringe has not been positioned correctly or has been disturbed during operation. Check the syringe location and the position.
PRESSURE DISC OUT	The pressure disc has been removed from the pressure transducer during the infusion. The infusion will stop. Replace the pressure disc then restart the infusion.
BATTERY LOW	Battery charge low with 30 minutes operation remaining. Battery indicator will flash and after 30 minutes a continuous audible alarm will indicate that the battery is exhausted. Reconnect to the AC power supply to continue operation and charge the internal battery.
BATTERY EMPTY	The internal battery is exhausted. Connect the pump to the AC power supply.
NEAR END OF INFUSION	The pump is nearing the end of the infusion. This value can be configured.
END OF INFUSION	The pump has reached the end of the infusion. A pre-set volume will remain in the syringe to minimise the risk of the infusion of air bubbles into the set. This value can be configured.
TITRATION NOT CONFIRMED	The infusion rate has been changed, but has not been confirmed and 2 minutes* has expired without any operation. Press the  button to silence the alarm, then press the CANCEL softkey to clear this message and silence the alarm. Check infusion rate and confirm by pressing the  button or press the  button to revert to the previous rate. Press the  button to start infusion. (This alarm only occurs if rate titration is enabled).
VTBI DONE	The pre-set Volume To Be Infused is complete.
AC POWER FAIL	AC Power has been disconnected and the pump is operating on battery power, if this occurs when the pump is infusing the message " INFUSION CONTINUES " will be displayed. Reconnect AC power supply or press the  button to silence the alarm and continue with battery operation. The alarm will automatically cancel if the AC power supply is reconnected.
Error Code and Message	The alarm system has detected an internal malfunction. Note the malfunction code. Remove pump from service for examination by a qualified service engineer.
ATTENTION (with "3 Beeps")	Three beeps will sound if the pump has been left ON for more than 2 minutes* (referred to as CALLBACK in the log) without starting the operation. Press the  button to silence the alarm for a further 2 minutes*. Alternatively press and hold down the  button and wait for 3 beeps in succession, this will put the warning alarm on standby for 15 minutes.
Alarm Indicator Colour	Alarms indicated
AMBER	AC POWER FAIL; NEAR END OF INFUSION; VTBI DONE (KVO or CONTINUE), ATTENTION; TITRATION NOT CONFIRMED; BATTERY LOW.
RED	All others.



*Configurable option.

Configured Options

This menu comprises a list of options which are configurable by the user.

1. Turn the pump **OFF**.
2. Whilst holding down the  button turn the pump **ON**.
3. The main display will show **000**. Enter the access code for Configured Options using the   keys, pressing **NEXT** to move through the digits. A full list of access codes can be found in the Technical Service Manual.
4. When the complete code shows on screen, press **OK** to enter. The Configured Options menu will be displayed.

General Options

1. Select **GENERAL OPTIONS** from the menu using the   keys and press the **OK** softkey.
2. Select the option you wish to enable/disable or adjust and press the **MODIFY** softkey.
3. When all the desired modifications have been carried out press the **QUIT** softkey.
4. Either select the next configuration option from the menu or turn the pump **OFF**, returning it to operation as required.

NURSE CALL FITTED	Enables Nurse Call (hardware option).
NURSE CALL INVERT	When enabled, the nurse call output is inverted.
RS232 SELECTED	Sets the pump's communications to use RS232 (hardware option).
NEOI WARNING	Sets the Near End Of Infusion warning time, as time left to End Of Infusion.
EOI POINT	Sets the End Of Infusion point.
KVO AT EOI	When enabled the pump will switch to running at the KVO rate when EOI is reached.
KVO RATE	Sets the Keep Vein Open (KVO) rate at which the pump will operate if KVO at EOI is enabled.
BACK OFF	When enabled the motor will reverse to relieve line pressure when an occlusion occurs.
AUTO SAVE	When disabled the infusion information is cleared on power up.
RATE LOCK	When enabled the rate can be locked to prevent unwanted changes of the set infusion rate.
QUIET MODE	When enabled the button beeps are muted.
AC FAIL	When enabled the AC Power Failure Alarm will sound if the AC power is disconnected.
RATE TITRATION	When enabled the rate can be changed whilst the pump is infusing.
PRESSURE DISPLAY	Enables / disables the Pressure Icon on the main display.
AUTO PRESSURE	Enables / disables the automatic pressure alarm level option.
AUTO SET PRESSURE	Automatically sets the line occlusion pressure to a specified amount above the current pressure.
AUTO OFFSET	Adjusts the automatic offset value used by auto pressure and auto set pressure. Adjustable from 15 to 100mmHg.
PRESSURE DEFAULT	Sets the default occlusion alarm level.
MAX PRESSURE	Sets the maximum pressure limit.
WEIGHT	Sets the default patient weight in kg.
CAP RATE	Sets the maximum value for infusion rate.
PURGE RATE	Sets the purge rate.
PURGE VOLUME LIMIT	Sets the maximum permissible purge volume.
PURGE SYRINGE	Prompt to purge syringe after confirmation.
BOLUS	Enables / disables the bolus feature.
DEFAULT BOLUS	Sets the default bolus rate.
CAP BOLUS RATE	Sets the maximum value for bolus rate.
BOLUS VOL LIMIT	Sets the maximum permissible bolus volume.
MANUAL BOLUS	Volume infused will be increased if plunger is manually moved in and syringe remains confirmed.
CALL BACK TIME	Adjusts the time for the pump to sound the call back alarm.
VTBI CLEAR RATE	Rate will be set to zero when VTBI has been set-up with stop as the end rate.
EVENT LOG DISPLAY	Enables / disables the event log.
BATTERY ICON	Enables / disables the Battery Icon on the main display.
AUDIO VOLUME	Sets the alarm volume of the pump at high, medium or low.
AUTO NIGHT MODE	Backlight dims between hours 21:00 and 06:00.

Alaris® CC Syringe Pump Configured Options Record

General Options

Enter the pump-specific information for your records on a copy of this page.

Option	Default		Range	Setting
	1.5.10 and 2.0.0	1.9.x and 2.3.x and above		
NURSE CALL FITTED	Disabled	Disabled	Enabled/Disabled	
NURSE CALL INVERT	Disabled	Disabled	Enabled/Disabled	
RS232 SELECTED	Disabled	Disabled	Enabled/Disabled	
NEOI WARNING	1min	5mins	1min - 15mins	
EOI POINT	1.0%	1.0%	0.1% - 5% of syringe volume	
KVO AT EOI	Enabled	Enabled	Enabled/Disabled	
KVO RATE	1.0ml/h	1.0ml/h	0.1ml/h - 2.5ml/h	
BACK OFF	Disabled	Enabled	Enabled/Disabled	
AUTO SAVE	Enabled	Enabled	Enabled/Disabled	
RATE LOCK	Disabled	Disabled	Enabled/Disabled	
QUIET MODE	Disabled	Disabled	Enabled/Disabled	
AC FAIL	Enabled	Enabled	Enabled/Disabled	
RATE TITRATION	Disabled	Disabled	Enabled/Disabled	
PRESSURE DISPLAY	Disabled	Enabled	Enabled/Disabled	
AUTO PRESSURE	Disabled	Enabled	Enabled/Disabled	
AUTO SET PRESSURE		Disabled	Enabled/Disabled	
AUTO OFFSET		30mmHg	15mmHg - 100mmHg	
PRESSURE DEFAULT	300mmHg	300mmHg	1mmHg - 1000mmHg	
MAX PRESSURE	1000mmHg	1000mmHg	1mmHg - 1000mmHg	
WEIGHT	70Kg	1.00Kg	0.01Kg - 250Kg	
CAP RATE	Max infusion rate	1200ml/h	1.0ml/h - 1200ml/h	
PURGE RATE	200ml/h	200ml/h	100ml/h - 500ml/h	
PURGE VOLUME LIMIT	2.0ml	2.0ml	0.5ml - 5.0ml	
PURGE SYRINGE		Disabled	Enabled/Disabled	
BOLUS	Enabled	Enabled	Enabled/Disabled	
DEFAULT BOLUS	Max bolus rate	500ml/h	10ml/h - 1200ml/h	
CAP BOLUS RATE	Max bolus rate	1200ml/h	10ml/h - 1200ml/h	
BOLUS VOL LIMIT	5.0ml	5.0ml	0.5ml (0.1ml)* - 25.0ml	
MANUAL BOLUS		Disabled	Enabled/Disabled	
CALL BACK TIME		2.0mins	0.1mins - 15mins	
VTBI CLEAR RATE		Disabled	Enabled/Disabled	
EVENT LOG DISPLAY	Disabled	Enabled	Enabled/Disabled	
BATTERY ICON		Enabled	Enabled/Disabled	
AUDIO VOLUME	Medium	Medium	Low, medium, high	
AUTO NIGHT MODE	Enabled	Enabled	Enabled/Disabled	

* For software versions 1.9.x and 2.3.x and above

Units Enabled

<input type="checkbox"/> ng/min	<input type="checkbox"/> µg/kg/min	<input type="checkbox"/> µg/24h	<input type="checkbox"/> mg/kg/min	<input type="checkbox"/> mg/24h	<input type="checkbox"/> g/24h	<input type="checkbox"/> U/h	<input type="checkbox"/> U/kg/24h
<input type="checkbox"/> ng/kg/min	<input type="checkbox"/> µg/h	<input type="checkbox"/> µg/kg/24h	<input type="checkbox"/> mg/h	<input type="checkbox"/> mg/kg/24h	<input type="checkbox"/> U/min	<input type="checkbox"/> U/kg/h	<input type="checkbox"/> kU/24h
<input type="checkbox"/> µg/min	<input type="checkbox"/> µg/kg/h	<input type="checkbox"/> mg/min	<input type="checkbox"/> mg/kg/h	<input type="checkbox"/> g/h	<input type="checkbox"/> U/kg/min	<input type="checkbox"/> U/24h	<input type="checkbox"/> mmol/h

Syringes Enabled

Make	Size(s)	Make	Size(s)

Hospital Name	Serial No.	Software Version
Approved by	Configured by	
Date	Date	

Configured Options (Continued)

Drug library

1. Select the **DRUG LIBRARY** option from the Configured Options menu and press the **OK** softkey.
2. To enter a new drug in the library press the **NEW** softkey.
3. To enter the name of the new drug use the \leftarrow \rightarrow \downarrow \uparrow keys to scroll through the alphabet. To select a letter press the **NEXT** softkey. On completion press the **OK** softkey.
4. Follow the flow chart, using the \leftarrow \rightarrow \downarrow \uparrow keys to select values. Use **OK** to enter selected values and move on to the next stage. The **BACK** softkey may be used at any time to return to the previous screen of the drug library set-up procedure.

Dosing Conversion:

1.0 μg = 1000 ng

1.0 mg/h = 24.0 mg/24 h

1.0 mg/min = 60.0 mg/h

1.0 mg = 1000 μg

The availability of drug dose units is dependent on the software version of the pump.

5. Review the drug set-up data on the display, then press the **OK** softkey to confirm.
6. To delete a drug from the drug library, select the drug using the \leftarrow \rightarrow \downarrow \uparrow keys. Press **MODIFY** then select **YES** twice to delete the drug from the list.

Note: to set a FIXED PROTOCOL set the:-

Max Doserate = Default Doserate = Min Doserate;



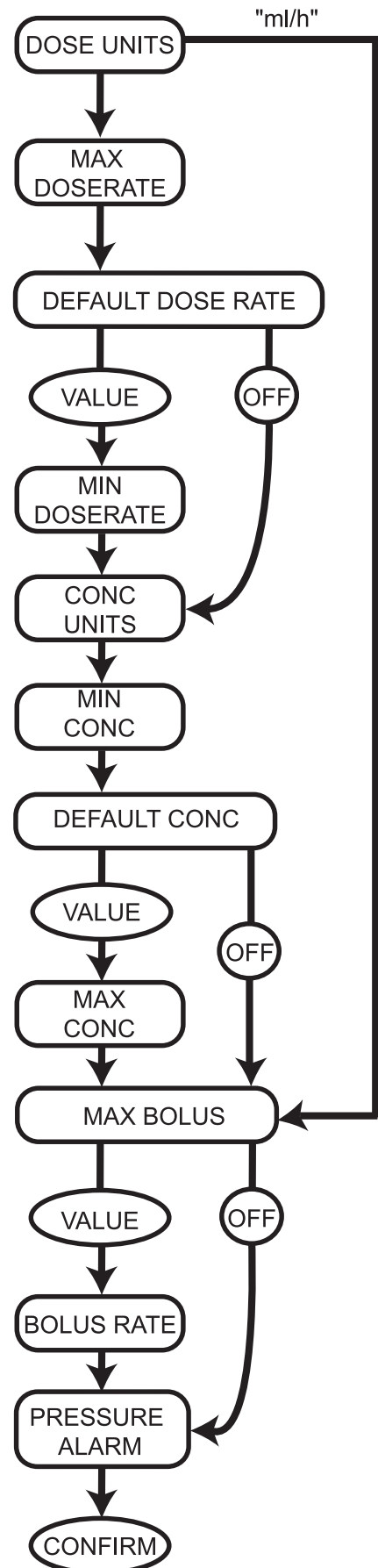

Max Conc. = Default Conc. = Min Conc.

Note: use of a protocol in which the Max Bolus is set OFF will prevent bolus delivery.







Configured Options (Continued)

Clock Set

1. Select **CLOCK SET** from the Configured Options menu using the   keys and press the **OK** softkey.
2. Use the   keys to adjust the date displayed, pressing the **NEXT** softkey to access the next field.
3. When the correct time and date are displayed press the **OK** softkey to return to the Configured Options menu.





Hospital Name

This option allows the user to programme in the name of the hospital, ward or department. This will appear during the power-up display sequence.

1. Select **HOSPITAL NAME** from the Configured Options menu using the   keys and press the **OK** softkey.
2. Use the   keys to adjust the character displayed, pressing **NEXT** to access the next position.
3. When the correct name is displayed press **OK** to return to the Configured Options menu.





Enable Syringes

This option is used to pre-configure the type and size of syringe permitted for use on the pump. Select all possible syringes which may be used and disable any that should not be used.

1. Select **ENABLE SYRINGES** from the Configured Options menu using the   keys and press the **OK** softkey.
2. Use the   keys to scroll through the list of syringes, pressing **MODIFY** to enable/disable a syringe brand and individual models within the brand.
3. When all modifications are complete press **QUIT** to return to the Configured Options menu.





Language

This option is used to set the language of messages shown on the pump display.

1. Select **LANGUAGE** from the Configured Options menu using the   keys and press the **OK** softkey.
2. Use the   keys to select the language.
3. When the desired language has been selected press **SELECT** softkey to return to the Configured Options menu.





Contrast

This option is used to set the contrast on the pump display.

1. Select **CONTRAST** from the Configured Options menu using the   keys and press the **OK** softkey.
2. Use the   keys to select a contrast ratio value. The contrast of the display will change when scrolling through the numbers.
3. When the desired value has been reached press the **OK** softkey to return to the Configured Options menu.

Enable Units

This option is used to pre-configure the type of units permitted for use on the pump. Select all possible units which may be used and disable any that should not be used.

1. Select **ENABLE UNITS** from the Configured Options menu using the   keys and press the **OK** softkey.
2. Use the   keys to scroll through the list of units, pressing **MODIFY** to enable/disable a unit.
3. When all modifications are complete press **OK** to return to the Configured Options menu.

Specifications

Infusion Specifications -

Maximum infusion rate can be set as part of the configuration.

0.1ml/h - 150ml/h	5ml syringes
0.1ml/h - 300ml/h	10ml syringes
0.1ml/h - 600ml/h	20ml syringes
0.1ml/h - 900ml/h	30ml syringes
0.1ml/h - 1200ml/h	50ml syringes

The Volume Infused range is 0.0ml - 9990ml.

Bolus Specifications -

Maximum Bolus rates can be set as part of the configuration. Bolus rates are user adjustable, in increments of 10ml/h.

10 ml/h - 150ml/h	5ml syringes
10 ml/h - 300ml/h	10ml syringes
10 ml/h - 600ml/h	20ml syringes
10 ml/h - 900ml/h	30ml syringes
10 ml/h - 1200ml/h	50ml syringes

The bolus volume limit can be set as part of the configuration.

Minimum: 0.5ml (0.1ml - v2.3.x and above or v1.9.x)
Maximum 25.0ml
Increments of 0.1ml; default 5.0ml

During BOLUS the pressure limit alarms are temporarily increased to their maximum level.

Critical Volume -

The bolus which can occur in the event of a single internal fault condition with a 50 ml syringe is :

Maximum Overinfusion - 0.5ml

Purge Specifications -

The purge rate is limited to the maximum rate for the syringe and can be set as part of the configuration.

100ml/h - 500ml/h.

The purge volume range is 0.5ml - 5ml.

During PURGE the pressure limit alarms are temporarily increased to their maximum level.

Keep Vein Open (KVO) Rate -

0.1 ml/h - 2.5ml/h.

End Of Syringe Rate -

Stop, KVO (0.1ml/h to 2.5ml/h), or set rate if lower than KVO.

Volume To Be Infused (VTBI) -

0.1ml - 100ml (0.1ml - 1000ml - v2.3.x and above or v1.9.x),
1min - 24h

VTBI Complete Rate -

Stop, KVO (0.1ml/h to 2.5ml/h), set rate if lower than KVO or continue at set rate.

Near End Of Infusion Alarm -

1min - 15min to end of infusion, or 10% of syringe volume, whichever is smaller.

End Of Infusion (EOI) Alarm -

0.1% - 5% of syringe volume

Maximum Pumping Pressure Limit -

Highest alarm level 1000mmHg (nominal at L-10)

Occlusion Accuracy without pressure set (% of full scale)* -

	Pressure mmHg			
	L-0 approx. 50 mmHg	L-3 approx. 300 mmHg	L-5 approx. 500 mmHg	L-10 approx. 1000 mmHg
Temp. 23°C	±18%	±21%	±23%	±28%

Occlusion Accuracy with pressure set (% of full scale)* -

	Pressure mmHg			
	0	25	500	1000
Temp. 23°C	±2%	±4%	±5%	±6%
Temp. 5 °C - 40 °C	±4%	±7%	±7%	±10%

* - Using most common 50ml syringes under normal conditions (95% confidence / 95% of pumps).

Electrical Classification -

Class I product. Continuous Mode Operation, Transportable

System Accuracy -

Volumetric Mean +/- 2% (nominal).

Derating -

Temperature +/- 0.5% (5 - 40°C)

High Rates +/-2.0% (rates > syringe volume/h eg. >50ml/h in a 50ml syringe.)

Important: System accuracy is +/-2% typical by volume as measured using the trumpet curve test method defined in IEC/EN60601-2-24 at rates of 1.0ml/h (23°C) and above when the pump is used with the recommended syringes. Differences in factors such as size and plunger force in compatible syringes can cause variations in accuracy and trumpet curves. See also trumpet curves section in this manual.

Drug Specification -

A maximum of 50 drugs with a maximum of 12 characters are available with V1.9.x and below software.

A maximum of 100 drugs with a maximum of 17 characters are available with V2.3.x and above software.

Battery Specifications -

Rechargeable sealed NiMH. Automatically charges when the pump is connected to AC power.

Mean Time To Battery Empty from fully charged @ 5ml/h and 20°C under normal conditions is 6 hours*

*95% lower confidence interval of 5 hours 50 minutes

Charging takes 2½ hours from discharge to 90% charge.

Memory Retention -

The electronic memory of the pump will be retained for more than 6 months when not powered up.

Fuse Type -

2 x T 1.25A, slow blowing.

AC Power Supply -

115 - 230VAC, 50 - 60Hz, 20VA (nominal).

Dimensions -

335 mm (w) x 121 mm (h) x 200 mm (d). Weight: 2.7 kg (excluding power cable).

Protection against fluid ingress -

IPX1 - Protected against vertically falling drops of water.

Alarm Conditions -

Drive Disengaged	Occlusion
Check Syringe	Battery Low / Battery Empty
Near End Of Infusion	End of Infusion
VTBI Done	AC Power Fail
Internal Malfunction	Attention (Nurse Callback)
Pressure Disc Out	Titration not confirmed
Line Occlusion	

Environmental Specifications -

Operating Temperature	+5°C - +40°C
Operating Relative Humidity	20% - 90%
Operating Atmospheric Pressure	700hPa - 1060hPa
Transport and Storage Temperature	-30°C - +50°C
Transport and Storage Relative Humidity	10% - 95%
Transport and Storage Atmospheric Pressure	500hPa - 1060hPa

Electrical/Mechanical Safety -

Complies with IEC/EN60601-1 and IEC/EN60601-2-24.

EMC -

Complies with IEC/EN60601-1-2 and IEC/EN60601-2-24.

Compatible Syringes

The pump is calibrated and labelled for use with single-use disposable Luer lock syringes. Only use the size and type of syringe specified on the pump display. The full list of permitted syringe models is dependent on the software version of the pump.

	5ml	10ml	20ml	30ml	50ml
IVAC®					✓
AstraZeneca					✓
B Braun Omnifix	✓	✓	✓	✓	✓
B Braun Perfusor			✓		✓
BD Perfusor					✓
BD Plastipak	✓	✓	✓	✓	✓
BD Precise			✓		✓
Codan		✓	✓	✓	✓
Codan Perfusion					✓
Fresenius Injectomat		✓			✓
Monoject**	✓	✓	✓	✓	✓
Nipro	✓		✓	✓	✓
Pentaferte	✓	✓	✓		✓
Rapiject*					✓
Terumo	✓	✓	✓	✓	✓

* - The Rapiject 50ml syringe is a specialised syringe with a large diameter barrel. To provide protection against accidental dislodging always ensure the infusion line is secured using the infusion set hook - see Loading a Syringe section.

** - ≡TYCO / Healthcare KENDALL - MONOJECT.

Associated Products

The Alaris® DS Docking Station

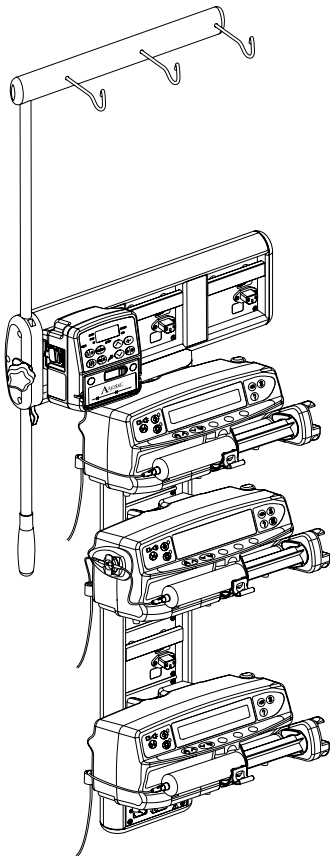



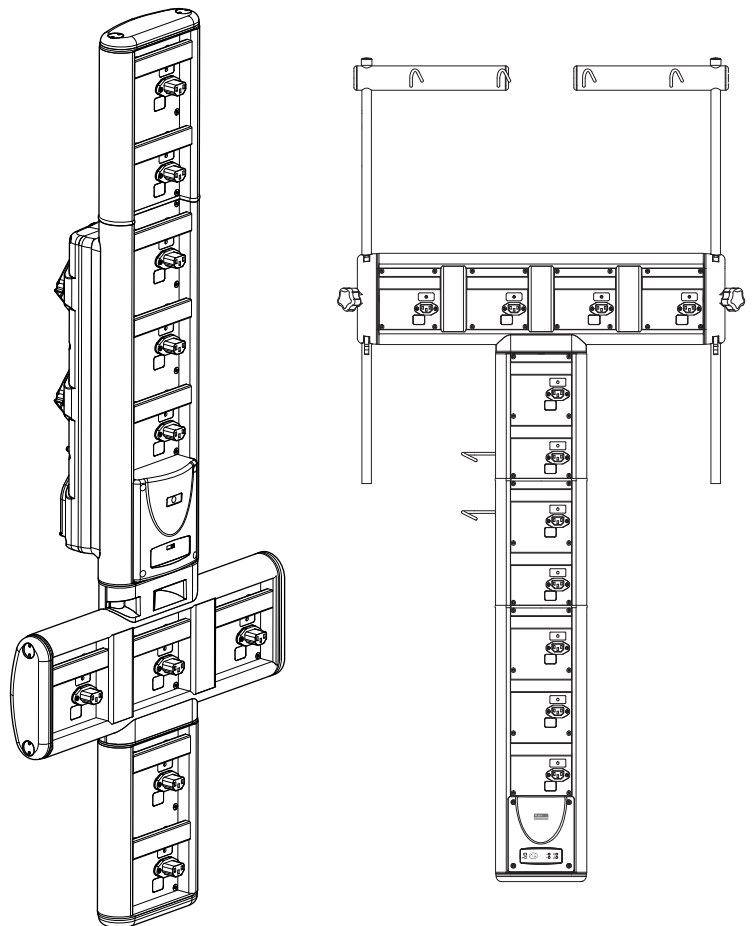

The Alaris® Gateway Workstation



Compatible Extension Sets

The pump uses standard, single-use, disposable extension sets and syringes with Luer lock connectors. The user is responsible for verifying the suitability of a product used, if it is not recommended by CareFusion.

Standard Sets	
G40015	Standard PVC Syringe Extension Set (150 cm). Priming Volume: 2.6ml 
G40020B	Standard PVC Syringe Extension Set (200 cm). Priming Volume: 1.5ml 
G402EP	Extension set, Luer lock connectors. Kink resistant DEHP free PVC yellow striped tubing. Bore 1mm. Length 200cm. Priming volume 1.6ml. 
G30402M	Standard PVC Syringe Extension Set with occlusion sensing disc. (200 cm). Priming Volume: 1.5ml 
G302EP	Extension set, with pressure sensing disc, Luer lock connectors. Kink resistant DEHP free PVC yellow striped tubing. Bore 0.9mm. Length 200cm. Priming volume 1.5ml 



For availability please contact your local CareFusion representative because new sets are continuously being developed for our customers.

It is recommended that extension sets are changed in accordance with the Directions for Use. Carefully read the Directions For Use supplied with the extension set prior to use.

Please note these drawings are not to scale

Compatible Extension Sets (Continued)

The pump uses standard, single-use, disposable extension sets and syringes with Luer lock connectors. The user is responsible for verifying the suitability of a product used, if it is not recommended by CareFusion.



For availability please contact your local CareFusion representative because new sets are continuously being developed for our customers.

Light Protected Sets

G40215 Amber PE Syringe Extension Set (150 cm).
Priming Volume: 1.2ml



G40320 White PVC Syringe Extension Set (200 cm).
Priming Volume: 3.6ml



G30653M Opaque White PVC Syringe Extension Set with occlusion sensing disc. (200 cm).
Priming Volume: 1.5ml



Low Sorbing Sets

G40615 Polyethylene Syringe Extension Set (150 cm).
Priming Volume: 1.5ml



G40620 Polyethylene Syringe Extension Set (200 cm).
Priming Volume: 2ml



G30303M Polyethylene Syringe Extension Set with occlusion sensing disc. (200 cm).
Priming Volume: 1.5ml

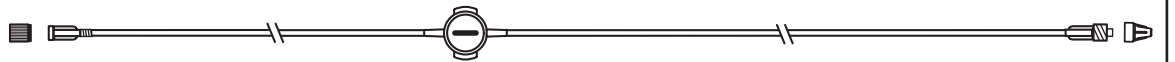

G30453M Opaque White PVC low sorbing Syringe Extension Set with occlusion sensing disc. (200 cm).
Priming Volume: 1.5ml

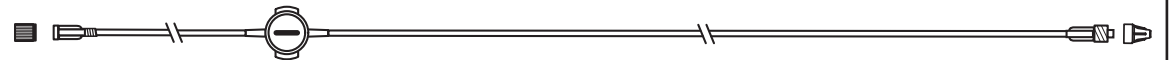

G30302M Polyethylene Lined Syringe Extension Set with occlusion sensing disc and clamp. (200 cm).
Priming Volume: 1.6ml

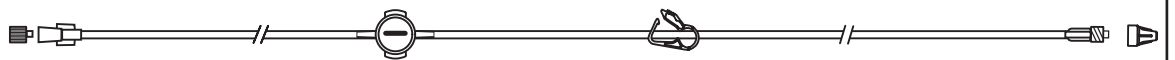

G40720 Polyethylene Lined Syringe Extension Set with clamp. (200 cm).
Priming Volume: 1.5ml

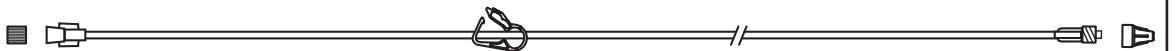

04105010509 Polyethylene Syringe Extension Set (100 cm).
Priming Volume: 1ml

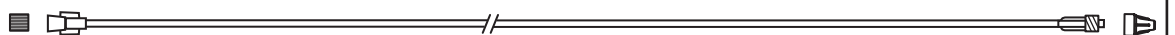

It is recommended that extension sets are changed in accordance with the Directions for Use.
Carefully read the Directions For Use supplied with the extension set prior to use.

Please note these drawings are not to scale

Compatible Extension Sets (Continued)

The pump uses standard, single-use, disposable extension sets and syringes with Luer lock connectors. The user is responsible for verifying the suitability of a product used, if it is not recommended by CareFusion.



For availability please contact your local CareFusion representative because new sets are continuously being developed for our customers.

Patient Controlled Analgesia (PCA) Sets

30822

PVC Syringe Extension Set with clamp (152 cm).
Priming Volume: 0.5ml



30832

PVC 'Y' Syringe Extension Set with back check valve and 2 clamps (178 cm).
Priming Volume: 1.5ml

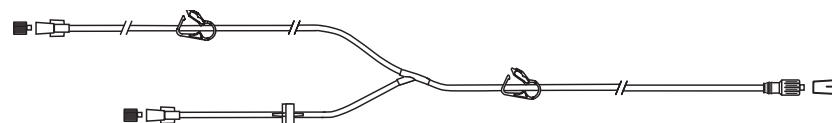

30842E

PVC Syringe Extension Set with back check valve, SmartSite® Needle-Free Valve Port and clamp (30 cm).
Priming Volume: 1.4ml

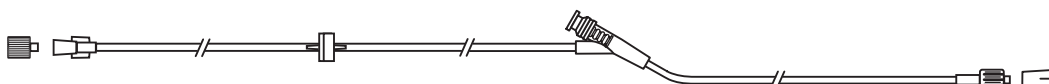

30852

PVC 'Y' Syringe Extension Set with anti-siphon valve, back check valve and 2 clamps (183 cm).
Priming Volume: 1.8ml

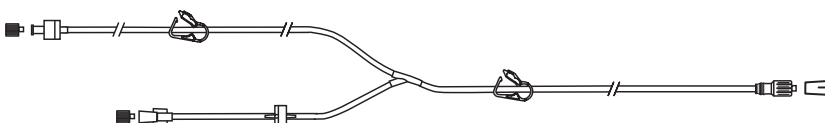

30862

PVC Syringe Extension Set with anti-siphon valve and clamp (156 cm).
Priming Volume: 0.6ml

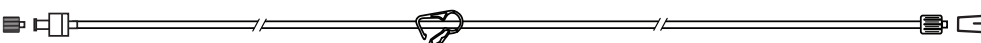

04102215162

PVC Syringe Extension Set with rotating luer. (150 cm).
Priming Volume: 2.9ml

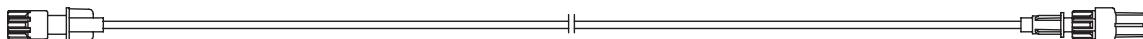

04100010162

PVC Syringe Extension Set (105 cm).
Priming Volume: 7.2ml



It is recommended that extension sets are changed in accordance with the Directions for Use.
Carefully read the Directions For Use supplied with the extension set prior to use.

Please note these drawings are not to scale

Maintenance

Routine Maintenance Procedures

To ensure that this pump remains in good operating condition, it is important to keep it clean and carry out the routine maintenance procedures described below.

Interval

As per Hospital Policy

Each usage

Before the transfer of the pump to a new patient and as required

Routine Maintenance Procedure

Thoroughly clean external surfaces of the pump before and after prolonged period of storage.

1. Inspect AC power supply plug and cable for damage.
2. Inspect case, keypad and plunger for damage.
3. Check Start up self test operation is correct.

Clean the pump by wiping over with a lint-free cloth lightly dampened with warm water and a standard disinfectant / detergent solution.



If the pump is dropped, damaged, subjected to excessive moisture or high temperature, immediately take it out of service for examination by a qualified service engineer.

All preventative and corrective maintenance and all such activities shall be performed at a compliant work place in accordance with the information supplied. CareFusion will not be responsible should any of these actions be performed outside the instructions or information supplied by CareFusion. For Preventative and Corrective Maintenance instructions please refer to the Technical Service Manual (TSM).

All servicing should only be performed by a qualified service engineer with reference to the TSM.



Please refer to Technical Service Manual for calibration procedures. The units of measurement used in the calibration procedure are standard SI (The International System of Units) units.

Battery Operation

The internal rechargeable battery allows continued operation when the AC power is unavailable, for example during patient transfer or AC power failure. Mean Time To Battery Empty from fully charged @ 5ml/h and 20°C under normal conditions is 6 hours*. From the battery low alarm it will take about 2½ hours to 90% charge when reconnected to the AC power supply, whether the pump is in use or not.

The battery is maintenance free, sealed Nickel Metal Hydride and requires no routine servicing. However, to achieve optimum operation, ensure that the battery is fully recharged after full discharge, before storage, and at regular 3 month intervals during storage.

Charge retention will eventually degrade. Where retention is critical the internal battery should be replaced every 3 years.

It is recommended that only a qualified service engineer replaces the battery. For further information regarding the replacement of batteries refer to the Technical Service Manual.

The battery pack used in this Alaris® Syringe Pump is manufactured by CareFusion and includes a proprietary PCB (printed circuit board) designed specifically for the Alaris® Syringe Pump, and in conjunction with Alaris® Syringe Pump software, controls battery use, charge and temperature. Any use of battery packs that are not manufactured by CareFusion in the Alaris® Syringe Pump is at your sole risk, and CareFusion does not provide any warranty for or endorsement on any battery packs that are not manufactured by CareFusion. CareFusion's product warranty shall not apply in the event the Alaris® Syringe Pump has suffered damage or premature wear, or malfunctions or otherwise operates incorrectly, as a result of use with a battery pack that is not manufactured by CareFusion.

*95% lower confidence interval of 5 hours 50 minutes

Maintenance (continued)

Cleaning and Storage

Before the transfer of the pump to a new patient and periodically during the use, clean the pump by wiping over with a lint-free cloth lightly dampened with warm water and a standard disinfectant / detergent solution.

Recommended cleaners are:

Brand	Concentration
Hibiscrub	20% (v/v)
Virkon	1% (w/v)

Do not use the following disinfectant types:

- Disinfectants which are known to be corrosive to metals must not be used, which include:
 - NaDcc (such as Presept),
 - Hypochlorites (such as Chlorasol),
 - Aldehydes (such as Cidex),
 - Cationic Surfactants (such as Benzalkonium Chloride).
- Use of Iodine (such as Betadine) will cause surface discoloration.
- Concentrated Isopropyl alcohol based cleaners will degrade plastic parts.

The syringe and extension sets are disposable single use items and should be discarded after use according to their manufacturers' instructions.

If the pump is to be stored for an extended period it should be first cleaned and the internal battery fully charged. Store in a clean, dry atmosphere at room temperature and, if available, employ the original packaging for protection.

Once every 3 months during storage, carry out functional tests as described in the Technical Service Manual and ensure that the internal battery is fully charged.



Before cleaning always switch OFF and disconnect from the AC power supply. Never allow liquid to enter the casing and avoid excess fluid build up on the pump. Do not use aggressive cleaning agents as these may damage the exterior surface of the pump. Do not steam autoclave, ethylene oxide sterilise or immerse this pump in any fluid.

Ensure the pressure transducer is free from residues, which may prevent correct operation of the disc detector.

Disposal

Information on Disposal for Users of Waste Electrical and Electronic Equipment

This  symbol on the product and/or accompanying documents means that used electrical and electronic products should not be mixed with household waste.

If you wish to discard electrical and electronic equipment, please contact your CareFusion affiliate office or distributor for further information.

Disposing of this product correctly will help to save valuable resources and prevent any potential negative effects on human health and the environment which could otherwise arise from inappropriate waste handling.

Information on Disposal in Countries outside the European Union

This symbol is only valid in the European Union. The product should be disposed of taking environmental factors into consideration. To ensure no risk or hazard, remove the internal rechargeable battery and the Nickel Metal Hydride battery from the control board and dispose of as outlined by the local country regulations. All other components can be safely disposed of as per local regulations.

Occlusion Pressure Limits

Time to alarm following occlusion is achieved in less than 30 minutes at rates of 1 ml/h and higher by the appropriate selection of occlusion levels.

Use of the dedicated pressure set is recommended. Its use permits the occlusion alarm pressure (mmHg) to be set accurately, with a small operating margin between the alarm and normal infusion pressures. When using infusion pumps with a pressure set, line pressures are estimated from pumping force. For this reason the occlusion alarm needs to be set with an operating margin of at least one level between the alarm and normal infusion levels. The ability to set a small operating margin permits short time to alarm and small potential bolus volumes to be achieved. Bolus volumes can be minimised as described in the Alarms and Warnings - Occlusion or by enabling the back off general option.

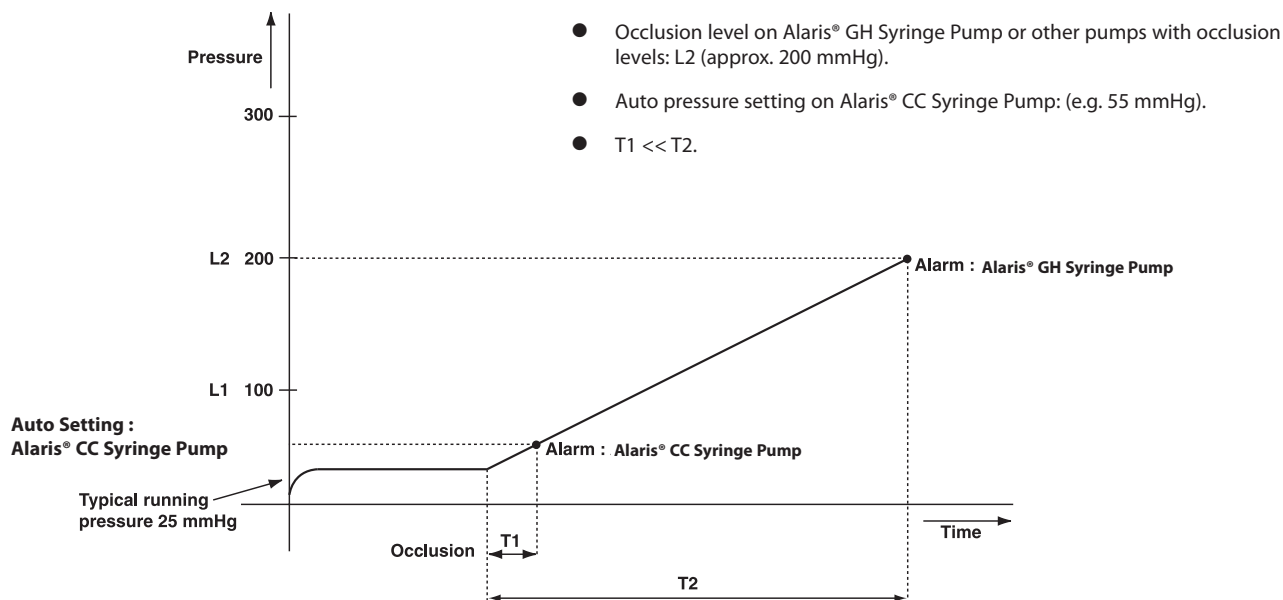

With Pressure Set fitted. G30402M - (Standard disposable extension set)

The following graphs show the typical values for time to alarm and bolus volume that can be expected in the event of an occlusion when the BD Plastipak 50 ml syringe is selected with a G30402M extension set with occlusion sensing disc.

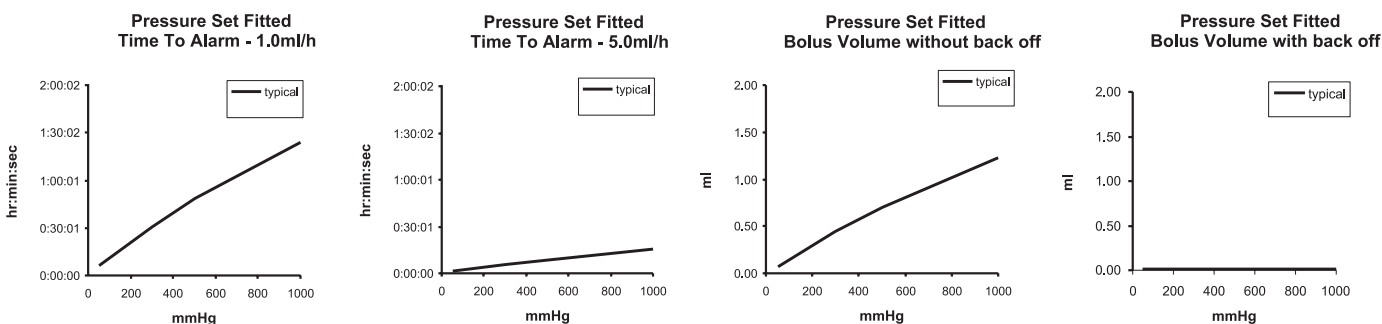

Without Pressure Set fitted. G40020B - (Standard disposable extension set)

The following graphs show the typical values for time to alarm and bolus volume that can be expected in the event of an occlusion when the BD Plastipak 50 ml syringe is selected with a G40020B standard extension set.

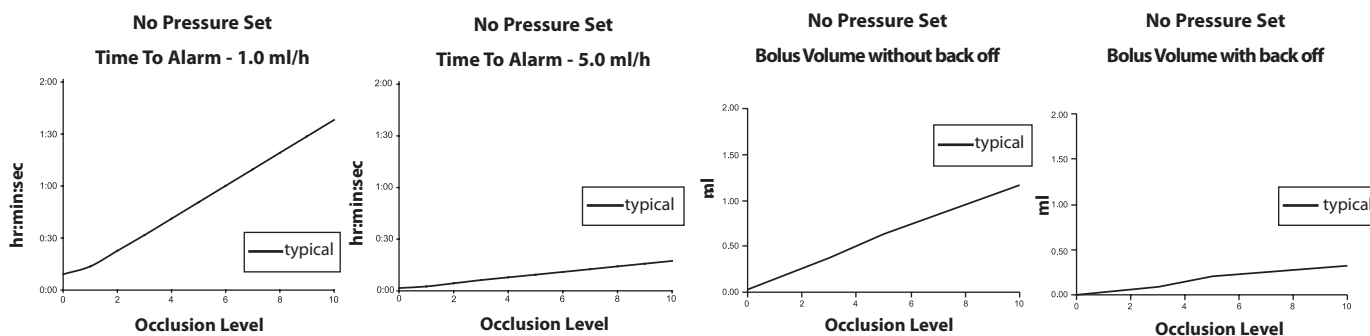

Tests at low alarm levels may alarm immediately - the force at these levels is commonly less than the friction in the syringe (with no additional fluid pressure). The result is that the pressure relating to the low forces will be less than the nominal quoted occlusion pressure.

Bolus volume following occlusion will be minimised by the back off feature if enabled. The back off will reduce the line pressure by removing the volume stored in the occluded line and deduct this volume from the volume infused. Back off will terminate if the pressure reaches the level recorded by the pump when the infusion was last started, or a maximum back off volume has been withdrawn from the infusion line. It will also terminate if the volume infused reaches 0.0ml, or a VTBI reaches the value at which it was set.

IrDA, RS232 and Nurse call Specification

IrDA / RS232 / Nurse call Feature

The RS232 / Nurse call feature is an optional feature on Alaris® Syringe Pumps. It allows the pump to be monitored remotely and/or controlled via a suitable central monitoring or computer system.

When the pump is started by a command from the serial interface, communication must take place over the serial interface, a communication must take place every 15 seconds or the pump will alarm, display communications failure and stop infusing. This failure protects against failure of the communications, including the removal of the RS232 cable.



The nurse call interface provides a remote backup to the internal audible alarm. It should not be relied upon to replace monitoring of the internal alarm.

Refer to the Technical Service Manual for further information regarding the RS232 interface. Since it is possible to control the syringe pump using the RS232 interface at some distance from the pump and hence remote from the patient, responsibility for the control of the pump is vested in the software run on the computer control system.

The assessment for the suitability of any software used in the clinical environment to control or receive data from the pump lies with the user of the equipment. This software should include detection of the disconnection or other failure of the RS232 cable. The protocol is detailed in the Technical Service Manual and is for general information only.

Any connected analogue and digital components are required to meet IEC/EN60950 for data processing and IEC/EN60601 for medical devices. Anyone connecting additional devices to the signal input or output is a system configurator and responsible for meeting the requirements of the system standard IEC/EN60601-1-1.

IrDA

Baud Rate	38.4 kBaud
Start Bits	1 Start Bit
Data Bits	8 Data Bits
Parity	No Parity
Stop Bits	1 stop bit

RS232 / Nurse call Connection Data

Nurse call Specification -

Connector	D Type - 9 Pin
TXD/RXD	EIA RS232-C Standard
TXD Output Voltage Range	Minimum: -5V (mark), +5V (space) Typical: -7V (mark), +7V (space) with 3kΩ load to ground
RXD Input Voltage Range	-30V - +30V max.
RXD Input Thresholds	Low: 0.6V minimum / High: 3.0V maximum
RXD Input Resistance	3kΩ minimum
Enable	Active, Low: -7V to -12V Active, High: +7V to +12V, powers up the isolated RS232 circuitry Inactive: Floating/open circuit, allows isolated RS232 circuitry to power down.
Isolation Socket/Pump	1.5kV (dc, or ac peak)
Baud Rate	38.4 kBaud
Start Bits	1 Start Bit
Data Bits	8 Data Bits
Parity	No Parity
Stop Bits	1 stop bit
Nurse Call Relay Contacts	Pins 1, 8 + 9, 30V dc, 1A rating

Typical Connection Data -

- 1 Nurse call (Relay) Normally Closed (NC C)
- 2 Transmit Data (TXD) Output
- 3 Received Data (RXD) Input
- 4 Power Input (DSR)
- 5 Ground (GND)
- 6 Not used
- 7 Power Input (CTS)
- 8 Nurse call (Relay) Normally open (NC O)
- 9 Nurse call (Relay) Common (NC COM)

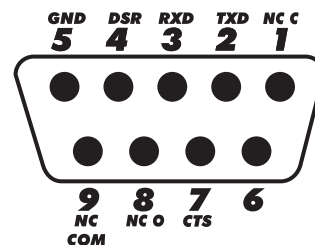

Trumpet Curves and Start-up Curves

In this pump, as with all infusion systems, the action of the pumping mechanism and variations in individual syringes cause short-term fluctuations in rate accuracy.

The following curves show typical performance of the system in two ways: 1) the delay in onset of fluid flow when infusion commences (start-up curves), and 2) the accuracy of fluid delivery over various time periods is measured (trumpet curves).

The start-up curves represent continuous flow versus operating time from the start of the infusion. They exhibit the delay in onset of delivery due to mechanical compliance and provide a visual representation of uniformity. Trumpet curves are derived from the second hour of this data. Tests performed per IEC/EN60601-2-24 standard.

Trumpet curves are named for their characteristic shape. They display discrete data averaged over particular time periods or 'observation windows', not continuous data versus operating time. Over long observation windows, short term fluctuations have little effect on accuracy as represented by the flat part of the curve. As the observation window is reduced, short term fluctuations have greater effects as represented by the "mouth" of the trumpet.

Knowledge of system accuracy over various observation windows may be of interest when certain drugs are being administered. Short term fluctuations in rate accuracy may have clinical impact depending on the half-life of the drug being infused, therefore the clinical effect cannot be determined from the trumpet curves alone.



Start-up and trumpet curves may not be indicative of operation under negative pressure.

Differences in factors such as size and plunger force in compatible syringes produced by other manufacturers can cause variations in accuracy and trumpet curves as compared to those represented. Additional curves for compatible syringes are available upon written request.

For applications where flow uniformity is a concern, rates of 1.0ml/h or above are recommended.

Start-up Trend. BD Plastipak 50ml @ 0.1ml/h

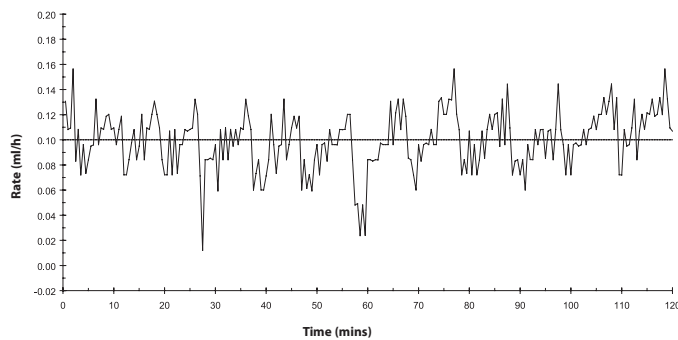

Trumpet Curve. BD Plastipak 50ml @ 0.1ml/h

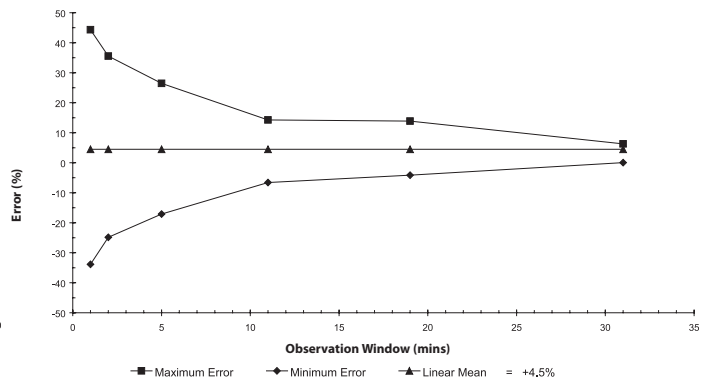

Start-up Trend. BD Plastipak 50ml @ 1.0ml/h

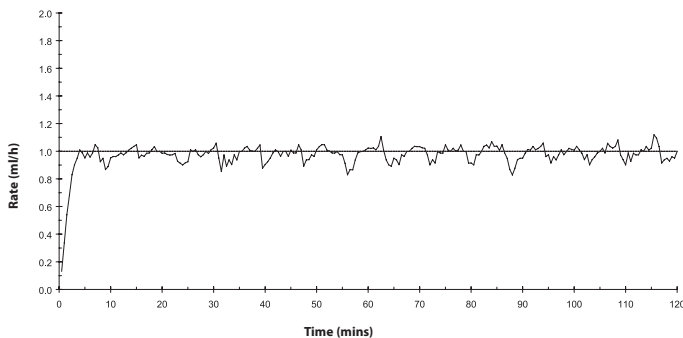

Trumpet Curve. BD Plastipak 50ml @ 1.0ml/h

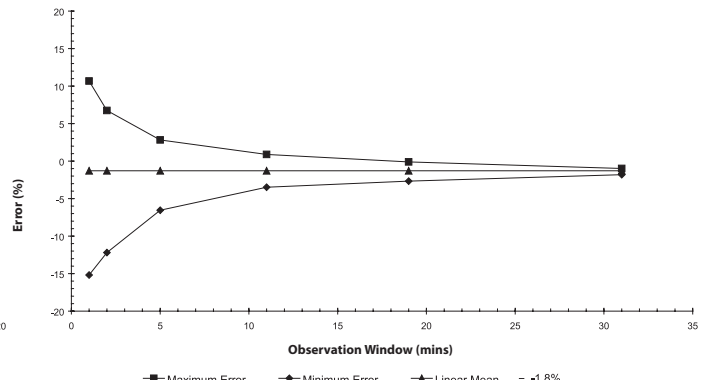

Start-up Trend. BD Plastipak 50ml @ 5.0ml/h

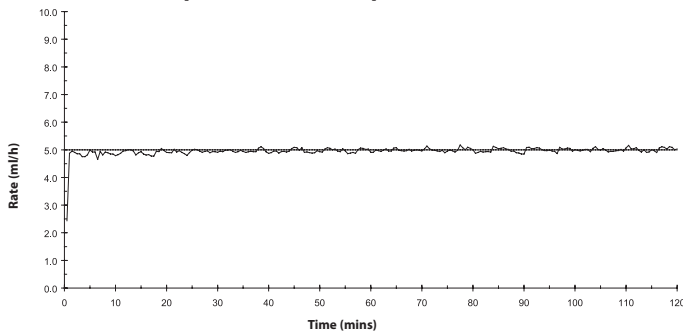

Trumpet Curve. BD Plastipak 50ml @ 5.0ml/h

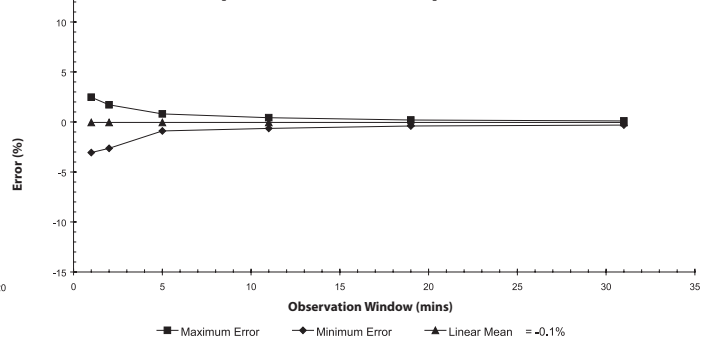

Alaris® Infusion System

Range of products in the Alaris® Infusion System product family are:

Part Number	Description
80013UN01	Alaris® GS Syringe Pump
80023UN01	Alaris® GH Syringe Pump
80033UND1	Alaris® CC Syringe Pump
80043UN01	Alaris® TIVA Syringe Pump
80053UN01	Alaris® PK Syringe Pump
80033UND1-G	Alaris® CC Guardrails® Syringe Pump
80023UN01-G	Alaris® GH Guardrails® Syringe Pump
80263UN01-G	Alaris® GP Guardrails® Volumetric Pump
274	Alaris® Transporter
80083UN00-xx ¹	Alaris® DS Docking Station
80203UNS0x-xx ¹	Alaris® Gateway Workstation

¹ For Docking Stations and Workstation contact local customer services representative to obtain configurations availability and part numbers.

Spare Parts

A comprehensive list of spare parts for this pump is included within the Technical Service Manual.

The Technical Service Manual (1000SM00001) is now available in electronic format on the World Wide Web at :-

<http://www.carefusion.com/alaris-intl/>

A username and password are required to access our manuals. Please contact local customer services representative to obtain login details.

Part Number	Description
1000SP01122	Internal Battery Pack
1001FAOPT91	AC Power Lead - UK
1001FAOPT92	AC Power Lead - European

Service Contacts

For service contact your local Affiliate Office or Distributor.

AE CareFusion, PO Box 5527, Dubai, United Arab Emirates. Tel: (971) 4 28 22 842 Fax: (971) 4 28 22 914	CN CareFusion, Shanghai Representative Office, Suite A, Floor 24, Shanghai Times Square Office Building, No.500 Zhangyang Road, Shanghai 200122, China. Tel: (86) 21 58368028 Fax: (86) 21 58368017	GB CareFusion, The Crescent, Jays Close, Basingstoke, Hampshire, RG22 4BS, United Kingdom. Tel: (44) 0800 917 8776 Fax: (44) 1256 330860	NZ CareFusion, 14B George Bourke Drive, Mt Wellington 1060, PO Box 14-518, Panmure 1741, Auckland, New Zealand Tel: 09 270 2420 Freephone: 0508 422734 Fax: 09 270 6285
AU CareFusion, 3/167 Prospect Highway, PO Box 355 Seven Hills, NSW 2147, Australia. Tel: (61) 2 9838 0255 Fax: (61) 2 9674 4444	DE CareFusion, Pascalstr. 2, 52499 Baesweiler, Deutschland. Tel: (49) 2401 604 0 Fax: (49) 2401 604 121	HU CareFusion, Döbrentei tér 1, H-1013 Budapest, Magyarország. Tel: (36) 14 88 0232 Tel: (36) 14 88 0233 Fax: (36) 12 01 5987	SE CareFusion, Hammarbacken 4B, 191 46 Sollentuna, Sverige. Tel: (46) 8 544 43 200 Fax: (46) 8 544 43 225
BE CareFusion, Leuvensesteenweg 248 D, 1800 Vilvoorde, Belgium. Tel: (32) 2 267 38 99 Fax: (32) 2 267 99 21	DK CareFusion, Firkovvej 25 B, 2800 Lyngby, Danmark. Tlf. (45)70 20 30 74 Fax: (45)70 20 30 98	IT CareFusion, Via Ticino 4, 50019 Sesto Fiorentino, Firenze, Italia. Tél: (39) 055 30 33 93 00 Fax: (39) 055 34 00 24	US CareFusion, 10020 Pacific Mesa Blvd., San Diego, CA 92121, USA. Tel: (1) 800 854 7128 Fax: (1) 858 458 6179
CA CareFusion, 235 Shields Court, Markham, Ontario L3R 8V2, Canada. Tel: (1) 905-752-3333 Fax: (1) 905-752-3343	ES CareFusion, Edificio Veganova, Avenida de La Vega, nº1, Bloque 1 - Planta 1, 28108 Alcobendas, Madrid, España. Tel: (34) 902 555 660 Fax: (34) 902 555 661	NL CareFusion, De Molen 8-10, 3994 DB Houten, Nederland. Tel: (31) 30 228 97 11 Fax: (31) 30 225 86 58	ZA CareFusion, Unit 2 Oude Molen Business Park, Oude Molen Road, Ndabeni, Cape Town 7405, South Africa. Tel: (27) (0) 860 597 572 Tel: (27) 21 510 7562 Fax: (27) 21 5107567
CH CareFusion Switzerland 221 Sàrl Critical Care A-One Business Centre Zone d'activités Vers-la-Pièce n° 10 1180 Rolle / Switzerland Ph.: 0848 244 433 Fax: 0848 244 100	FR CareFusion, Parc d'affaire le Val Saint Quentin 2, rue René Caudron 78960 Voisins le Bretonneux France Tél: (33) 1 30 05 34 00 Fax: (33) 1 30 05 34 43	NO CareFusion, Solbråveien 10 A, 1383 ASKER, Norge. Tel: (47) 66 98 76 00 Fax: (47) 66 98 76 01	

Document History

<i>Revision</i>	<i>CO Number</i>	<i>Date</i>
1	9684	October 2009

Page Intentionally Left Blank

Alaris, Guardrails, IVAC and Asena are registered trademarks of CareFusion Corporation or one of its subsidiaries. All rights reserved. All other trademarks are property of their respective owners.

© 2000-2009 CareFusion Corporation or one of its subsidiaries. All rights reserved.

This document contains proprietary information of CareFusion Corporation or one of its subsidiaries, and its receipt or possession does not convey any rights to reproduce its contents, or to manufacture or sell any product described. Reproduction, disclosure, or use other than for the intended purpose without specific written authorization of CareFusion Corporation or one of its subsidiaries is strictly forbidden.



CareFusion Switzerland 317 Sàrl,
CH-1180, Rolle



CareFusion U.K. 305 Ltd., RG22 4BS, UK

1000DF00329 Issue 1