

Thinking of you

 **Electrolux**

User manual 

ECN 26104 W
ECN 30104 W
ECN 40104 W
ECN 50104 W
ECO 30112 W
ECO 26112 W
ECP 21104 W
ECP 14104 W

We were thinking of you
when we made this product

Electrolux. Thinking of you.

Share more of our thinking at www.electrolux.com



Disposal

By ensuring this product is disposed of correctly, you will help prevent potential damaging consequences for the environment and human health.

The symbol on the product indicates that this product may not be treated as household waste, instead it should be taken to the appropriate collection point for the recycling of electrical and electronic equipment. For more detailed information about recycling of this product, please contact your local council, your household waste disposal service or the shop where you purchased the appliance.

Contents

Safety Information	4	Switch on-off	5
Product Description	4	Daily use	6
Control panel	4	Care and Cleaning	6
Display	5	Helpful hints and tips	7
Installation	5	What to do if...	8
Electrical connection	5	Service or repair	9
First use	5	Technical Data	9



Safety Information

Before installing and using the appliance read this user's instruction book carefully. It contains safety precautions, hints, information and ideas. If the freezer is used in compliance with these instructions, it will operate properly and provide you with the greatest satisfaction. These warnings are provided in the interest of safety. You must read them carefully before installing or using the appliance.

- Use the freezer only for storing frozen food, freezing fresh food and making ice cubes.
- Do not eat ice cubes or ice lollies immediately after taking them out of the freezer, as they may cause frost burns.
- Do not allow children to play or hide inside the freezer, as they may become trapped inside and suffocate.
- Do not store glass containers with liquids in the freezer, as they may burst.
- Ensure that the freezer is not resting on the power supply cable.
- Before servicing or cleaning, always unplug the appliance or disconnect the power supply.
- Do not use other electrical appliances (such as ice cream makers) inside the appliance.
- Your appliance contains an environmentally friendly natural gas, isobutane (R600a). Caution is required however, since isobutane is flammable. Therefore it is essential to ensure that the refrigerant pipelines are not damaged.

It is most important that this instruction book should be retained with the appliance for future reference.

Product Description

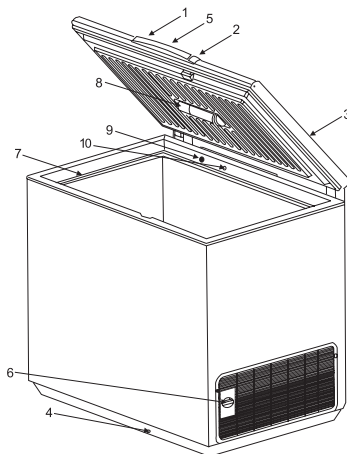

1. Lid handle
2. Security lock
3. Seal
4. Defrost water drain
5. Control panel
6. Thermostat knob: temperature adjustment
7. Upper edge
8. Light
9. Valve: easy re-opening of lid
10. Low-frost system: reduces ice-build-up in the chest freezer by up to 80 percent

Control panel

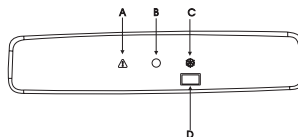

- A. Red light: Illuminates when the freezer temperature is not sufficiently low.
- B. Green light: Illuminates when the appliance is on.
- C. Yellow light: Illuminates when the Super Freeze function is activated.

- D. Super Freeze button: Activates/de-activates the Super Freeze function for large quantities for fresh food and switches off the beeping alarm.

Installation

- Wait at least 2 hours before connecting the freezer to the power supply to ensure the refrigerant circuit is fully efficient.
- Install the freezer in a dry, well ventilated room. Avoid locations near a source of heat or in direct sunlight.
- The room temperature should correspond to the climatic classification for which the freezer was designed, see chapter "Technical data".
- Place the freezer horizontally on a firm surface, resting on all four feet.
- For optimum operation and in order to avoid damage when the lid is opened, leave a space of at least 5 cm from the rear wall and 5 cm at the sides.
- Before connecting the freezer to the power supply, ensure that the voltage corresponds to that indicated in chapter "Technical data" under "Voltage".



Danger!

- Ensure that the freezer is not resting on the power supply cable.
- Do not remove the power supply cable by pulling on its lead, particularly when the freezer is being pulled out of its niche.
- The power supply cable may only be replaced by a qualified electrician.
- Ensure that the power plug is not squashed or damaged by the back of the freezer.
- There must be adequate ventilation around the appliance.
- Any electrical work required to install this appliance should be carried out by a competent electrician.

Electrical connection

The appliance is supplied with a 13amp plug fitted. In the event of having to change the fuse in the plug supplied, a 13amp ASTA approved (BS1362) fuse must be used. Should the plug need to be replaced for any reason. The wires in the power supply cable are coloured in accordance with the following code:

- Green and Yellow - Earth: must be connected to the terminal marked with the letter "E" or by the earth symbol or coloured green and yellow.
- Blue - Neutral: must be connected to the terminal "N" or coloured black.
- Brown - Live: must be connected to the terminal marked "L" or coloured red.

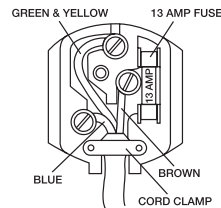

Upon completion there must be no cut, or stray strands of wire present and the cord clamp must be secure over the outer sheath.



Warning! This appliance must be earthed.

First use

- Before first use, the freezer should be cleaned inside, see chapter "Care and cleaning".
- Plug in the appliance.
- The green light will come on.
- The red light will also switch on and the alarm will beep, to indicate that the temperature inside the freezer is not yet cold enough for food storage.

- Press button (D) to switch the alarm off. The red light will normally switch off after several hours.
- Only place food inside the freezer once the red light has switched off.

Switch on-off

Switch on the freezer

- Turn the thermostat knob to a position between ❄️ and ❄️.

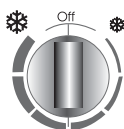

Switch off the freezer

- Turn the thermostat knob to the Off position.

Daily use

Temperature adjustment

To adjust the temperature of the freezer, proceed as follows:

- Turn the thermostat knob clockwise towards ❄️ for a colder storage temperature.
- Turn the thermostat knob counter-clockwise towards ❄️ for a less cold storage temperature.

Super Freeze function

If more than 3-4 kg of fresh food is to be frozen, the freezer needs to be pre-cooled.

- At least 24 hours before placing fresh food in the freezer, press button (D).
- The yellow light comes on.
- Place the food in the freezer. After 52

hours this function will automatically switch off and the freezer will return to normal storage temperature. This function can be de-activated any time by pressing button (D) again.

Alarm

If the freezer temperature is not cold enough, the alarm will beep and the red light will come on.

- Press button (D) to switch the sound off. The red light remains on as long as the temperature in the freezer is higher than the thermostat setting.

The alarm can be due to:

- Insertion of a large amount of fresh food.
- Opening the lid too long.
- A defect in the system, see chapter "What to do if...".

Storage baskets

- Hang the baskets on the upper edge (X) or place the stackable baskets inside the freezer (Y).
- Turn and fix the handles for these two positions, as shown in the drawings.

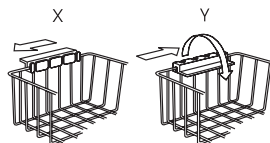

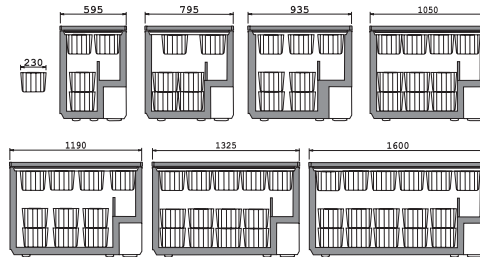

Spare baskets can be obtained from your local Service Force Centre or from the Electrolux website (depending on country). The illustrations on this page show how many baskets can be placed in the various freezer models.



Security lock

The freezer is equipped with a special lock in order to avoid accidental locking. The lock is designed in such manner that you can turn the key and thus close the lid only if you previously push the key into the lock.

- In order to close the freezer, gently push the key into the lock and turn it clockwise towards the symbol .
- In order to open the freezer, gently push the key into the lock and turn it counter-clockwise towards the symbol .

Spare keys are available from the local service center.

Keep the key out of reach of children.

Prior to disposing of your old freezer, remove the key from the lock.

Opening and closing the lid

As the lid is fitted with a tightly closing seal, it will not re-open easily immediately after closing.

- Wait a few minutes before re-opening the lid. The valve will allow the lid to be re-opened easily. Never pull the handle with immense force.

Care and Cleaning

Defrosting the freezer

- Disconnect the appliance from the power supply.
- Remove all loose accessories and the vented floor, as shown on the illustration.
- Use a damp cloth to clean your freezer. Use hot water and a mild, non-aromatic detergent.
- Clean the loose accessories and the vented floor, before replacing them again.

Important! Never use strong detergents, scouring powder or aromatic detergents to clean your freezer.

Cleaning

The best time to clean your freezer is after defrosting.

- Disconnect the appliance from the power supply and remove all loose accessories.
- Use a damp cloth to clean your freezer. Use hot water and a mild, non-aromatic detergent.
- Clean the loose accessories, before replacing them again.

Important! Never use strong detergents, scouring powder or aromatic detergents to clean your freezer.

When not in use

- Disconnect the appliance from the power supply.
- Remove all food from the freezer.
- Clean the freezer as described above.
- Leave the lid slightly open.

Changing the light bulb

- Disconnect the appliance from the power supply.
- Unscrew the bulb, and replace it with a new bulb (max. 15W).
- Plug in the appliance.

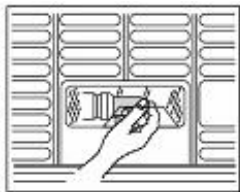

i Helpful hints and tips

Freezing food

- Before freezing, fresh food must be packed in airtight and moisture-proof packaging to prevent it from drying out.
- Only use fresh food of the best quality.
- Always leave hot food to cool to room temperature before placing in the freezer.
- Divide food into small portions before freezing; this ensures that freezing is more rapid, and that you only need to defrost the amount needed for immediate consumption.
- Mark the freezer packaging with the date of freezing.

- Place fresh food for freezing close to the cold sides of the freezer, making sure that it is not in contact with the frozen food already in the freezer.
- Frozen food can be stored anywhere inside the freezer, but should be kept at least 5 mm below the upper edge.

If freezing is too slow, the quality of the food being frozen deteriorates. The amount of fresh food (expressed in kg) that can be frozen in 24 hours is indicated in the chapter "Technical data" under "Freezing capacity".

Food storage

- For fresh frozen food, please refer to the storage period table underneath.
- For purchased frozen food, never exceed the expiry date.
- When you buy frozen food, make sure that it has been stored at the correct temperature. Do not buy products which have wet or damaged packaging. Place purchased products in your freezer as quickly as possible. We recommend using an insulated bag to bring such products home with you.

Important! Remember that fully or partially defrosted food must not be re-frozen. However, dishes which have been cooked using defrosted food may be frozen.



In the case of a power failure or breakdown

- Do not open the lid.

Important! If the power has been off for longer than the value shown in the

chapter "Technical data" under "Hold-over time", the defrosted food must be consumed quickly or cooked immediately and then refrozen (after cooling).

What to do if...

Try the solutions suggested here first to avoid the cost of an unnecessary service call.

Your freezer will not operate

- Is the power supply cord unplugged?
- Has a household fuse blown?
- Is there a power failure?
- Is the temperature control set to the Off position?

The alarm remains audible and/or the red light/symbol () is on

- Is the lid not closed completely? See underneath for any obstructions.
- Is the temperature control set correctly for the surrounding conditions?
- Is the freezer too close to a source of heat?

The inside light does not work

- Is the power supply cord unplugged?
- Is the light bulb loose in the socket or burned out?

The motor seems to run too much

- Is the lid not closed completely? See underneath for any obstructions.
- Is the room temperature hotter than normal?
- Has a large amount of fresh food just been added to the freezer?
- Is the lid opened often?
- Is the temperature control set correctly for the surrounding conditions?
- Is the lid seal damaged or deformed?
- Is there enough air circulation space around the freezer?

- Is the Super Freeze function activated accidentally?

Temperature is too warm

- Has a large amount of food just been added to the freezer?
- Is the lid opened often?
- Is the temperature control set correctly for the surrounding conditions?

The lid will not close completely

- Is there excessive frost or a package preventing the lid from closing?
- Are food packages blocking the lid?
- Is the lid seal dirty or sticky?
- Does the freezer wobble or seem unstable?

The lid is difficult to open

- Is the lid seal dirty or sticky?
- Is the valve blocked?

If you still need help, please contact your local Service Force Centre.

Service or repair

In cases of breakdown or faults, your freezer must be serviced by an authorized Electrolux Service engineer.

Important! Under no circumstances should you attempt to repair the appliance yourself

Technical Data

Model		BNI 280 ECN26104W	BNI 325 ECN30104W	BNI425 ECN40105W	BNI525 ECN50104W
Volume (gross)	Litre	213	304	404	500
Volume (net)	Litre	210	300	400	495
Height	Cm	87,6	87,6	87,6	87,6
Width	Cm	79,5	105	132,5	160
Depth	Cm	66,5	66,5	66,5	66,5
Weight	Kg	39	49	56	66
Energy consumption/24h	kWh/24h	0,78	0,957	1,452	1,338
Freezing capacity	kg/24h	14	17	19	20
Hold-over time	Hours	28	32	31	31
Rated power	Watt	84	87	82	125
Voltage	Volts	230	230	230-	230
Climatic class		SN-T	SN-T	SN-T	SN-T

Model		BMI 310 ECO30112W	BMI265 ECO26112W	BNI225 ECP21104W	BNI 150 ECP 14104W
Volume (gross)	Litre	299	261	213	142
Volume (net)	Litre	292	255	210	140
Height	Cm	87,6	87,6	87,6	87,6
Width	Cm	132,5	119	79,5	59,5
Depth	Cm	66,5	66,5	66,5	66,5
Weight	Kg	63	57	39	35
Energy consumption/24h	kWh/24h	0,696	0,649	0,938	0,773
Freezing capacity	kg/24h	28	27	14	13
Hold-over time	Hours	52	50	26	25
Rated power	Watt	90	90	90	90
Voltage	Volts	230	230	230	230
Climatic class		SN/N/ST	SN/N/ST	SN	SN

Climatic classification	Ambient temperature limits
SN	from +10°C to +32°C
N	from +16°C to +32°C
ST	from +18°C to +38°C
T	from +18°C to +43°C

CE This appliance complies with the following EC Directives:

73/23/EEC of 19. 02. 1973 Low-Voltage Directive

89/336/EEC of 03. 05. 1989 (including Amendment Directive 92/31/EEC - EMC Directive)

www.electrolux.com
www.electrolux.en